

Cost and benefits of shifting towards low temperature district heating

Kirasić, Edi

Master's thesis / Diplomski rad

2021

Degree Grantor / Ustanova koja je dodijelila akademski / stručni stupanj: **University of Zagreb, Faculty of Mechanical Engineering and Naval Architecture / Sveučilište u Zagrebu, Fakultet strojarstva i brodogradnje**

Permanent link / Trajna poveznica: <https://urn.nsk.hr/urn:nbn:hr:235:225497>

Rights / Prava: [In copyright](#)/[Zaštićeno autorskim pravom.](#)

Download date / Datum preuzimanja: **2024-07-30**

Repository / Repozitorij:

[Repository of Faculty of Mechanical Engineering and Naval Architecture University of Zagreb](#)



UNIVERSITY OF ZAGREB
Faculty of Mechanical Engineering and Naval Architecture

MASTER'S THESIS

Edi Kirasić

Zagreb, 2021

UNIVERSITY OF ZAGREB
Faculty of Mechanical Engineering and Naval Architecture

MASTER'S THESIS

Supervisor:

Dr. Sc. Tomislav Pukšec

Student:

Edi Kirasić

Zagreb, 2021

Izjavljujem da sam ovaj rad izradio samostalno koristeći znanja stečena tijekom studija i navedenu literaturu.

Zahvaljujem se profesoru Tomislavu Pukšecu što mi je pružio priliku da pišem ovaj rada.

Posebno se zahvaljujem, Hrvoju Dorotiću, mentoru i prijatelju, na svom strpljenju, potpori i savjetima koja mi je pružio prilikom pisanja ovog rada, ali i tijekom studiranja.

Naravno, želim se zahvaliti čitavoj svojoj obitelji i prijateljima na potpori tijekom studiranja i nezaboravnih studentskih dana. Najviše se želim zahvaliti mami, svojoj sigurnoj luci i stijeni, ali i tati, koji je i tijekom cijelog mog studiranja s neba pazio na mene.

Edi Kirasić



SVEUČILIŠTE U ZAGREBU
FAKULTET STROJARSTVA I BRODOGRADNJE



Središnje povjerenstvo za završne i diplomske ispite
Povjerenstvo za diplomske ispite studija strojarstva za smjerove:

Procesno-energetski, konstrukcijski, inženjersko modeliranje i računalne simulacije i brodstrojarski

| | |
|--|--------|
| Sveučilište u Zagrebu Fakultet strojarstva i brodogradnje | |
| Datum | Prilog |
| Klasa: 602 - 04 / 21 - 6 / 1 | |
| Ur.broj: 15 - 1703 - 21 - | |

DIPLOMSKI ZADATAK

Student: **Edi Kirasić** JMBAG: 0035199944

Naslov rada na hrvatskom jeziku: **Troškovi i prednosti prelaska na nisko-temperaturne centralizirane toplinske sustave**

Naslov rada na engleskom jeziku: **Cost and benefits of shifting towards low temperature district heating**

Opis zadatka:

Decarbonisation of energy systems represent crucial challenge in the upcoming years. One of the potential solutions to reduce fossil fuel consumption and decrease carbon emissions is shift from high temperature to low temperature district heating networks, caused by building stock refurbishment. Lower operating temperatures enable operational cost reduction triggered by lower heat losses and higher supply technology efficiency. However, these networks require additional system investments such as implementation of higher quality substations and installation of decentralised booster heating units. The main objective of this master thesis is to provide cost-benefit analysis of shifting from high-temperature to low-temperature district heating systems.

Candidate will have to perform following tasks to successfully develop master thesis:

1. Perform literature review on low and ultra-low district heating networks and the transition from high temperature district heating systems;
2. Upgrade existing optimization district heating model, developed at the Department, by integrating correlation of network temperature with technology efficiency;
3. Develop at least three district heating supply scenarios defined with different technology mixes;
4. Analyse the impact of temperature network reduction for different heat supply scenarios while focusing on primary energy consumption and carbon emissions;
5. Provide cost benefit analysis of network temperature reduction by considering discounted investments and operational cost reduction.

Necessary data and literature can be obtained from the supervisor. Finally, it is mandatory to reference used literature and help gained during thesis writing.

Zadatak zadan:

Datum predaje rada:

Predvideni datumi obrane:

4. ožujka 2021.

6. svibnja 2021.

10. – 14. svibnja 2021.

Zadatak zadao:

Predsjednik Povjerenstva:

Doc.dr.sc. Tomislav Pukšec

Prof. dr.sc. Tanja Jurčević Lulić

TABLE OF CONTENT

| | |
|--|------|
| TABLE OF CONTENT | I |
| LIST OF FIGURES | II |
| LIST OF TABLES | III |
| NOMENCLATURE..... | IV |
| LIST OF ABBREVIATIONS (ACRONYMS)..... | V |
| SUMMARY | VII |
| SAŽETAK..... | VIII |
| 1. INTRODUCTION | 1 |
| 2. LOW AND ULTRA-LOW TEMPERATURE DISTRICT HEATING..... | 3 |
| 2.1. Heat sources | 3 |
| 2.2. Thermal energy storage..... | 5 |
| 2.3. Network design | 6 |
| 2.4. Consumer substation | 8 |
| 2.4.1. Space heating | 8 |
| 2.4.2. Domestic hot water preparation | 10 |
| 3. METHOD | 16 |
| 3.1. Heat demand | 16 |
| 3.2. Network heat losses and pumping power | 17 |
| 3.3. Heat pumps coefficients of performances..... | 19 |
| 3.4. Systems seasonal coefficient of performance | 22 |
| 3.5. Levelized cost of heat, carbon emission, and primary energy factors | 23 |
| 4. CASE STUDY..... | 24 |
| 4.1. Input data..... | 29 |
| 4.2. System components sizing and costs | 34 |
| 5. RESULTS AND DISCUSSION..... | 37 |
| 5.1. Levelized cost of heat (LCOH)..... | 38 |
| 5.2. Primary energy factor..... | 51 |
| 5.3. CO ₂ factor | 57 |
| 6. CONCLUSION | 63 |
| ACKNOWLEDGEMENT | 64 |
| LITERATURE | 65 |
| ANNEX..... | 69 |

LIST OF FIGURES

| | | |
|-----------|--|----|
| Figure 1 | District heating development timeline [1]..... | 1 |
| Figure 2 | Different types of connection to existing network [8] | 5 |
| Figure 3 | Tree and ring structure of a DH [7] | 6 |
| Figure 4 | Twin pipe configurations [4]..... | 7 |
| Figure 5 | Double pipe network [4]..... | 7 |
| Figure 6 | Space heating temperature regimes in different systems [13]..... | 8 |
| Figure 7 | Direct connection of SH [14] | 9 |
| Figure 8 | Indirect connection of SH [14]..... | 9 |
| Figure 9 | Legionella growth/decay rate [7] | 10 |
| Figure 10 | Instantaneous heat exchanger unit [7] | 11 |
| Figure 11 | District heating storage unit [7]..... | 12 |
| Figure 12 | Apartment DHW units in multi-storey building [7]..... | 12 |
| Figure 13 | Booster HP with DH storage on the primary side [14] | 13 |
| Figure 14 | Booster HP for DHW (parallel connection to heating) [14] | 13 |
| Figure 15 | Booster HP for DHW (serial connection to heating) [14]..... | 14 |
| Figure 16 | Operation modes of booster HP on the secondary side [14] | 14 |
| Figure 17 | Air booster HP on the secondary side [14]..... | 15 |
| Figure 18 | Heat loss data from existing DH networks in Denmark [15] | 18 |
| Figure 19 | Cycle of a simple heat pump process and its heat load diagram [21] | 19 |
| Figure 20 | Lorenz efficiency curves [21]..... | 21 |
| Figure 21 | Four scenarios considered in the calculation [15] | 24 |
| Figure 22 | LTDH network | 25 |
| Figure 23 | ULTDH network with booster HP at consumer substation..... | 25 |
| Figure 24 | ULTDH network with micro HP at consumer substation | 26 |
| Figure 25 | ULTDH network with ASHP at consumer substation | 26 |
| Figure 26 | Average outdoor temperature in Croatia in 2018 [26] | 29 |
| Figure 27 | Relative SH demand curve for Croatia in 2018 [13]..... | 30 |
| Figure 28 | Relative DHW demand curve for Croatia in 2018 [13] | 30 |
| Figure 29 | Heat loss curve [27]..... | 31 |
| Figure 30 | ULTDH temperature variations [28]..... | 32 |
| Figure 31 | LTDH temperature variations [28]..... | 32 |
| Figure 32 | ULTDH network temperatures through the year | 33 |
| Figure 33 | LTDH network temperatures through the year | 33 |
| Figure 34 | Pipe total cost as a diameter function [36] | 35 |
| Figure 35 | LTDH network COP values | 37 |
| Figure 36 | ULTDH network COP values | 37 |
| Figure 37 | LCOH values for SH share=0,1 and plot ratio=0,2..... | 38 |
| Figure 38 | Detailed overview of LCOH, SH share=0,1, plot ratio=0,2..... | 39 |
| Figure 39 | LCOH values for SH share=0,5 and plot ratio=1,2..... | 40 |
| Figure 40 | Detailed overview of LCOH, SH share=0,5, plot ratio=1,2..... | 41 |
| Figure 41 | LCOH values for SH share=0,8 and plot ratio=2,0..... | 42 |
| Figure 42 | Detailed overview of LCOH, SH share=0,8, plot ratio=2,0..... | 43 |

LIST OF TABLES

| | | |
|----------|--|----|
| Table 1 | ULTDH and LTDH main characteristics [3] | 3 |
| Table 2 | TES characteristics [10] | 5 |
| Table 3 | Scenarios characteristics..... | 27 |
| Table 4 | Temperature of LTDH and ULTDH networks [°C]..... | 28 |
| Table 5 | DH components investment cost [15] | 34 |
| Table 6 | Components O&M costs | 35 |
| Table 7 | LCOH-LTDH_Micro_ASHP | 44 |
| Table 8 | LCOH-ULTDH_Micro_GWHP..... | 45 |
| Table 9 | LCOH-ULTDH_Micro_EH1HEX..... | 46 |
| Table 10 | LCOH-ULTDH_Micro_EH2HP | 46 |
| Table 11 | LCOH-ULTDH_Micro_EH3HP | 47 |
| Table 12 | LCOH-ULTDH_Air_ASHP..... | 48 |
| Table 13 | LCOH-ULTDH_Booster_ASHP..... | 48 |
| Table 14 | LCOH-LTDH_ASHP | 49 |
| Table 15 | The Lowest LCOH | 49 |
| Table 16 | The Lowest LCOH-cases | 50 |
| Table 17 | The Lowest LCOH without the EH..... | 51 |
| Table 18 | The Lowest LCOH without the EH-cases..... | 51 |
| Table 19 | Primary energy factor-ULTDH_Micro_ASHP | 52 |
| Table 20 | Primary energy factor-ULTDH_Micro_GWHP | 53 |
| Table 21 | Primary energy factor-ULTDH_Micro_EH1HEX..... | 53 |
| Table 22 | Primary energy factor-ULTDH_Micro_EH2HP..... | 54 |
| Table 23 | Primary energy factor-ULTDH_Micro_EH3HP | 54 |
| Table 24 | Primary energy factor-ULTDH_Air_ASHP | 55 |
| Table 25 | Primary energy factor-ULTDH_Booster_ASHP | 55 |
| Table 26 | Primary energy factor-LTDH_ASHP..... | 56 |
| Table 27 | The lowest primary energy factor | 56 |
| Table 28 | CO ₂ factor-ULTDH_Micro_ASHP..... | 57 |
| Table 29 | CO ₂ factor-ULTDH_Micro_GWHP | 58 |
| Table 30 | CO ₂ factor-ULTDH_Micro_EH1HEX..... | 58 |
| Table 31 | CO ₂ factor-ULTDH_Micro_EH2HP..... | 59 |
| Table 32 | CO ₂ factor-ULTDH_Micro_EH3HP..... | 59 |
| Table 33 | CO ₂ factor-ULTDH_Air_ASHP | 60 |
| Table 34 | CO ₂ factor-ULTDH_Booster_ASHP | 61 |
| Table 35 | CO ₂ factor-LTDH_ASHP..... | 61 |
| Table 36 | The lowest carbon emission factor | 62 |

NOMENCLATURE

| | |
|-------|--|
| LTDH | Low-temperature district heating |
| ULTDH | Ultra-low temperature district heating |
| DH | District heating |
| DHW | Domestic hot water |
| SH | Space heating |
| HEX | Heat exchanger |
| HP | Heat pump |
| HTDH | High-temperature district heating |
| TES | Thermal energy storage |
| RES | Renewable energy source |
| IHEU | Instantaneous heat exchanger |
| DHSU | District heating storage unit |
| EU | European Union |
| UV | Ultraviolet |
| LHDD | Linear heat density demand |
| ASHP | Air source heat pump |
| GWHP | Groundwater heat pump |
| EH | Excess heat |
| GB | Gas boiler |

LIST OF ABBREVIATIONS (ACRONYMS)

| Nomenclature | Unit | Description |
|--------------------------|-------------|---|
| q_{DHW} | kWh/m^2a | specific annual domestic hot water demand |
| $A_{district}$ | m^2 | district area |
| $A_{buildings}$ | m^2 | buildings area |
| ϵ | – | plot ratio |
| $Q_{tot,DHW}$ | MWh/a | total annual domestic hot water demand |
| s_H | – | space heating share |
| q_S | kWh/m^2a | specific annual heat demand |
| q_{SH} | kWh/m^2a | specific annual space heating demand |
| Q_{tot} | MWh/a | total annual heat demand |
| $Q_{tot,SH}$ | MWh/a | total annual space heating demand |
| w | – | effective width |
| q_l | MWh/m | linear heat density demand |
| L | m | trench length |
| d_a | m | average pipe diameter |
| Q_{loss} | MWh/a | total annual heat losses |
| T_{supply} | $^{\circ}C$ | network supply temperature |
| T_{return} | $^{\circ}C$ | network return temperature |
| T_{ground} | $^{\circ}C$ | ground temperature |
| \bar{T}_{supply} | $^{\circ}C$ | weighted average supply temperature |
| \bar{T}_{return} | $^{\circ}C$ | weighted average return temperature |
| \dot{V} | m^3/h | volume flow |
| $Q_{tot,delivered}$ | MWh/a | total annual heat delivered to the network |
| c_{p,H_2O} | $kWh/(kgK)$ | water isobaric specific heat |
| ρ_{H_2O} | kg/m^3 | water density |
| Δp_{DH} | Pa | pressure drop in the system |
| $\Delta p_{network}$ | Pa/m | pressure drop in the network |
| $\Delta p_{substations}$ | Pa | pressure drop at consumer substations |
| η_{pump} | – | pump efficiency |
| W_{pump} | MWh/a | annual pump electricity consumption |
| $T_{C,i}$ | K | the inlet temperature of source in an evaporator |
| $T_{C,o}$ | K | the outlet temperature of source in an evaporator |
| ΔT_C | K | a temperature difference of source in an evaporator |
| $T_{H,i}$ | K | the inlet temperature of a sink in heat pump condenser |
| $T_{H,o}$ | K | the outlet temperature of a sink in heat pump condenser |
| ΔT_H | K | a temperature difference of sink in an evaporator |
| \bar{T}_H | K | mean temperature of a sink |

| | | |
|-------------------------|---------|--|
| \bar{T}_C | K | mean temperature of a source |
| $\Delta\bar{T}_{lift}$ | K | temperature lift |
| COP_{Lorenz} | – | Lorenz coefficient of performance |
| η_{Lorenz} | – | Lorenz efficiency |
| COP | – | coefficient of performance |
| $\dot{Q}_{central}$ | MW | the heat produced from the central unit in an hour |
| $COP_{decentral}$ | – | coefficient of performance of the decentral unit |
| \dot{Q} | MW | the heat produced in an hour |
| \dot{W} | MW | electricity consumed in an hour |
| W_{tot} | MWh/a | total annual electricity consumption of district heating |
| $W_{central}$ | MWh/a | annual central unit electricity consumption |
| $W_{decentral}$ | MWh/a | annual decentral units electricity consumption |
| $COP_{system,seasonal}$ | – | system seasonal coefficient of performance |
| $LCOH$ | $€/MWh$ | levelized cost of heat |
| $CAPEX$ | $€$ | the capital cost of heat |
| $OPEX$ | $€$ | the operational cost of heat |
| CRF | – | capital recovery factor |
| I | $€$ | investment |
| i | % | discount rate |
| n | a | project lifetime |
| $O\&M$ | $€$ | operation and maintenance cost |
| E | $€$ | total electricity cost |
| G | $€$ | total gas cost |
| $f_{prim,scenario}$ | – | primary energy factor of a scenario |
| f_{prim} | – | primary energy factor |
| $f_{CO_2,scenario}$ | – | CO ₂ factor of a scenario |
| f_{CO_2} | – | CO ₂ factor |
| T_{tot} | MWh/a | total annual gas consumption |
| $\dot{Q}_{decentral}$ | MW | decentral unit heat capacity |
| $t_{fullload}$ | h | full load hours |

SUMMARY

Current energy and climate strategies will eventually phase out conventional district heating systems unless they are prepared for lower heat demand caused by building refurbishment and energy efficiency improvement programs. Also, future district heating systems will need to reduce heat losses and CO₂ emissions and replace fossil fuels with locally found renewable energy and urban waste heat sources. Those changes will have a widespread positive impact on communities. This thesis evaluates the costs and benefits of the novel, low, and ultra-low temperature district heating systems, which are the path to the future.

The introduction of this thesis gives a short overview of LTDH and ULTDH systems, as well as their main components and literature review. The second part, method, shows the techno-economical procedure of assessing the costs and benefits of these systems. Heat demand, electricity consumption, coefficients of performances, heat losses and other important parameters in district heating analysis are presented. The section-case study describes the example for which assessment methodology is developed. This section shows techno-economic data used in the analysis. In the last section, results from the case study are evaluated and discussed. Results showed the infeasibility of novel district heating systems for low plot ratios and space heating shares, but they outperformed conventional natural gas boiler heating in CO₂ emissions and primary energy consumption. All results from this case study are shown in the Annex at the end.

Keywords: ultra-low temperature district heating, low-temperature district heating, heat pumps, renewable energy sources, cost-benefit analysis, coefficient of performance, levelized cost of heat, energy planning, carbon emission factor, primary energy factor

SAŽETAK

Trenutne energetske i klimatske strategije će u konačnici uzrokovati gašenje konvencionalnih centraliziranih toplinskih sustava, ako ne budu spremni na smanjenje potreba za toplinskom energijom uzrokovanih programima energetske obnove zgrada i poboljšanja energetske učinkovitosti. Također, centralizirani toplinski sustavi budućnosti trebat će smanjiti toplinske gubitke i emisije CO₂, a potrošnju fosilnih goriva morat će zamijeniti lokalnim obnovljivim izvorima energije i urbanim izvorima otpadne topline. Te promjene će imati dalekosežni pozitivan utjecaj na zajednice. Ovaj diplomski rad procjenjuje koristi i troškove novih, nisko-temperaturnih i izrazito nisko-temperaturnih centraliziranih toplinskih sustava koji su put prema budućnosti.

U uvodu je dan kratki pregled nisko-temperaturnih i izrazito nisko-temperaturnih centraliziranih toplinskih sustava, kao i pregled njihovih osnovnih komponenti i literature. Drugi dio, metoda, prikazuje tehno-ekonomsku analizu procjena dobiti i troškova ovih sustava. Prikazane su potrebe za toplinskom energijom, potrošnja električne energije, koeficijent učinkovitosti dizalica topline, toplinski gubici i drugi važni parametri analize centraliziranih toplinskih sustava. U poglavlju-studija slučaja, opisan je primjer za koji je razvijena metodologija. U tom poglavlju su prikazani tehno-ekonomski podaci korišteni u analizi. U zadnjem poglavlju analizirani su rezultati koji pokazuju neisplativost izgradnje modernih centraliziranih toplinskih sustava za rijetko naseljena područja s malim udjelom potražnje za grijanjem u ukupnoj potražnji toplinske energije, ali su bolji po pitanju emisija CO₂ i potrošnji primarne energije od konvencionalnog grijanja prirodnim plinom. Svi rezultati ove analize slučaja prikazani su u dodatku koji se nalazi na kraju.

Ključne riječi: izrazito nisko temperaturni centralizirani toplinski sustavi, nisko temperaturni centralizirani toplinski sustavi, dizalice topline, obnovljivi izvori energije, analiza troškovi i dobiti, koeficijent učinkovitosti dizalica topline, nivelirana cijena toplinske energije, energetske planiranje, faktor emisije ugljikovog dioksida, faktor primarne energije

1. INTRODUCTION

District heating (DH) systems play an essential role in the energy sector because of the heat supply to consumers. The main advantages of this heating concept are heat production in one central place for all consumers, which reduces costs, and professional supervision of the system, which reduces system fouling. Traditional district heating systems can operate at temperatures above 100 °C, which can cause high heat losses or high investment costs to insulate pipes to reduce losses. Also, fossil fuels are the primary heat source of these systems. These problems are solved by developing new district heating networks known as fourth-generation district heating systems [1]. New networks operate with lower supply and return temperatures, and their primary heat source is either renewable energy sources or urban waste heat. The district heating development timeline, with all four district heating generations, is presented in Figure 1.

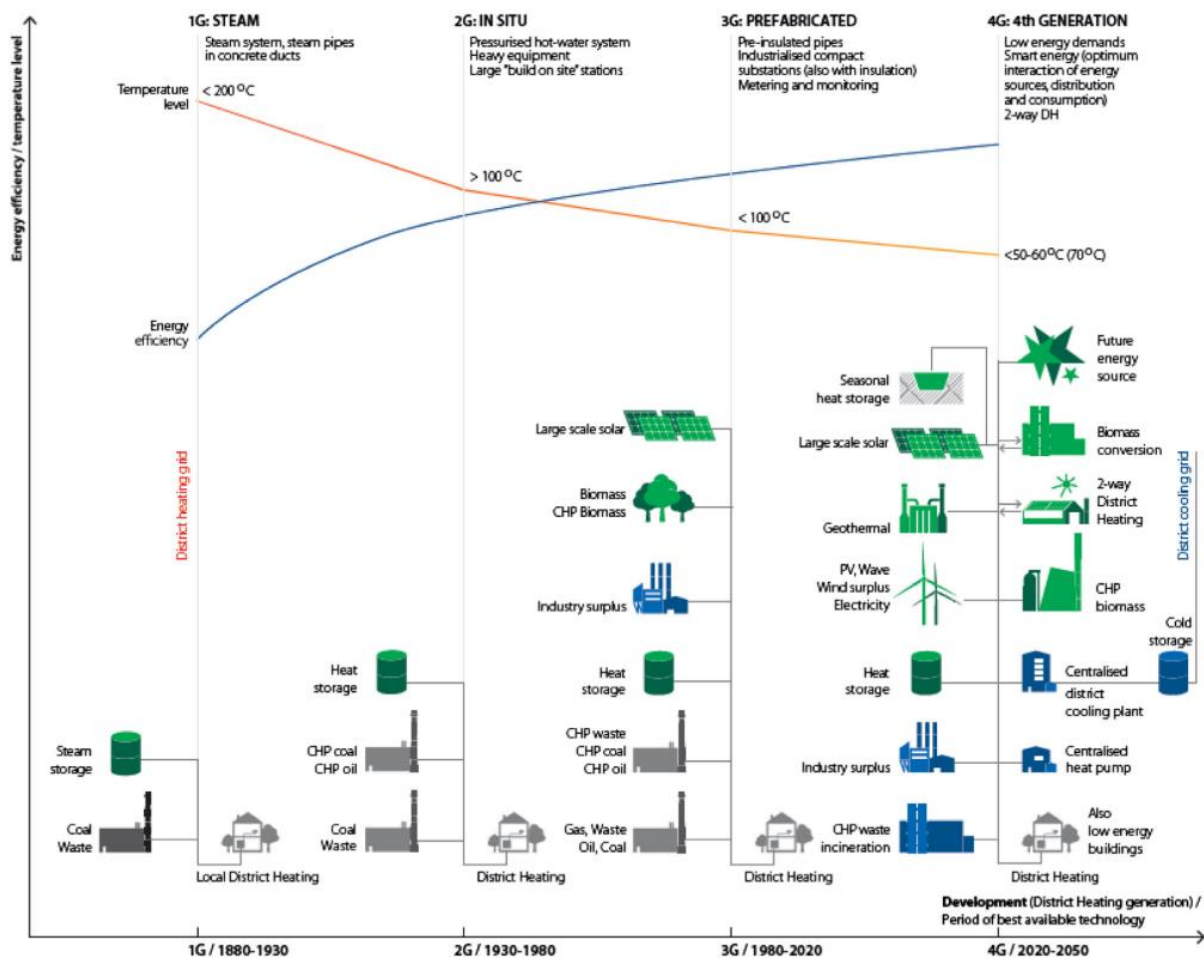

Figure 1 District heating development timeline [1]

By lowering district heating temperatures, low-temperature renewable heat sources can be implemented in the network, which helps to decarbonise this sector. Renewable energy sources can be locally found, making this sector more reliable and less dependent on leading fossil fuel exporters. Low temperatures lower heat losses and costs of the network, but temperatures can sometimes be so low that the booster heating unit at the consumer substation must be used to cover total heat demand. The need for an extra heating booster unit (mainly heat pumps) raises costs and sometimes causes the infeasibility of a whole project if costs are higher than the benefits that these new networks bring. For that reason, new district heating systems must be carefully planned.

Fourth-generation district heating systems can be classified into two separate groups, low and ultra-low temperature district heating systems (LTDH and ULTDH). The main difference between them is that domestic hot water (DHW) and space heating (SH) demand can be covered with heat delivered by the network in LTDH, while ULTDH systems need to have booster element, most often heat pump, at consumer substation to raise the temperature for DHW needs at higher temperatures to avoid *Legionella* [3].

2. LOW AND ULTRA-LOW TEMPERATURE DISTRICT HEATING

ULTDH and LTDH systems are significantly different compared to conventional district heating systems. Differences are lower temperatures, lower heat losses, lower CO₂ emissions and reliable heat supply. However, between them, differences are less significant but still noticeable. The main differences between ULTDH and LTDH are shown in Table 1. The main difference is that in the ULTDH network, consumers need to have a booster heating unit to raise the temperature for domestic hot water preparation because network supply temperatures are lower than 50°C, which does not secure sanitary water preparation. LTDH systems operate at higher network temperatures sufficient for DHW preparation, and they do not require an additional heating unit at the consumer substation.

Table 1 ULTDH and LTDH main characteristics [3]

| | LTDH | ULTDH |
|-----------------------------|---|--|
| Definition | The higher temperature of supply stream than required for direct heat exchange to heat demand-network temperatures are sufficient for DHW preparation | The lower temperature of supply stream than required for direct heat exchange to heat demand-additional heating unit for DHW preparation is required |
| Temperatures | Supply: e.g., 55 °C to 75 °C Return: e.g., 25 °C to 40 °C | Supply: e.g., 35 °C to 50 °C Return: e.g., 20 °C to 35 °C |
| Carrier | Water-based brine in closed-loop (sensible heat) | |
| Space heating | Floor heating or low-temperature radiators in a secondary system | |
| Hot water production | Efficient local heat exchanger heating DHW | The heat pump (or electric heater) increases the temperature to the required level by utilising DH as a heat source (other sources possible) |

2.1. Heat sources

Low-temperature regimes enable utilisation of low temperature-renewable heat sources into the network, such as solar systems, excess heat from industry, existing district heating return pipeline or other sources. If heat source temperature is not high enough to be directly utilised in the thermal network, heat pumps should be used. If the cogeneration plant is connected to the network, its power-to-heat ratio is increased because more electricity can be produced for the same level of heat production. The coefficient of performance (COP) of heat pumps is also higher in these networks because the needed temperature lift is reduced. Efficiencies of all renewable-based heat production plants are higher in these networks in general due to lower

temperatures. All that enables a connection of new heat sources to the network, which decentralises this sector [4].

Sources such as air, ground, groundwater, seawater are used the most because they are widespread, and their utilisation technology, heat pumps, operate at high efficiencies as technology advances. Solar energy is also entering the heating sector, but it must be often coupled with other sources or heat storages for periods without the sun [5]. When it comes to industrial excess heat, such as chemical or process industry, it can also be used in these networks directly through the heat exchangers, but lower temperature excess heat, e.g., from cooling, requires heat pumps. In industry, heat that would be otherwise discharged into the environment is used. Besides the environmental benefits, it is observed that it can profit excess heat producers from selling heat to the network and reduce costs concerning cooling water consumption [6]. Nevertheless, excess heat, either high or low grade, is not accessible as other sources, and if it is, its fluctuations and temperature regimes must be evaluated carefully before connecting to the district heating network [7].

If LTDH or ULTDH networks are planned near the existing high or medium temperature district heating systems, they can be supplied with heat from existing networks through heat exchangers (HEX), directly with a mixing shunt, three-pipe connection or a heat pump (HP). A mixing shunt is a direct connection to an existing network where supply water from that network is mixed with return water from ULTDH or LTDH network. At a three-pipe connection, the existing network supplies a low-temperature one with heat from its return line, but in the case of higher heat demand in ULTDH or LTDH, return water is mixed with supply water of the existing system [4]. If an HP is used, the return line from the existing network is heated with heat from the return line of the low-temperature network. The heat pump raises water temperature high enough to cover heat demand. Figure 2 depicts possibilities of connection to an existing network. Figure 2 -(a) shows the connection of the high-temperature district heating (HTDH) network through HEX to low-temperature consumers, (b) shows a mixing shunt between two networks and (c) shows a three-pipe connection [8].

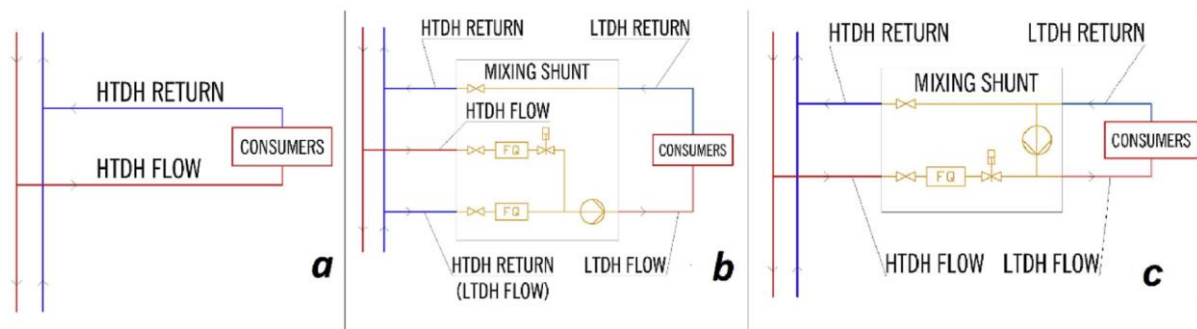

Figure 2 Different types of connection to existing network [8]

2.2. Thermal energy storage

Thermal energy storages (TES) can be used to prevent heat supply disruptions due to various factors, or they can be used as an alternative to utilise low-cost electricity via heat pumps. Because of that, they play a vital role in future energy systems supplied with heat from intermittent renewable energy sources (RES). Cheap storage medium, mostly water, and their simple construction cause their cost-effectiveness [9]. Table 2 shows different thermal storage types, including their main characteristics and differences.

Table 2 TES characteristics [10]

| Type | TTEA (tanks) | PTS (Pits) | BTES (Boreholes) | ATES (Aquifers) |
|--|--|--|--|---|
| Storage medium | Water | Water (gravel-water) | Soil surrounding the boreholes | Groundwater in aquifers |
| Specific capacity [kWh/m ³] | 60-80 | 60-80 (30-50 for gravel-water) | 15-30 | 30-40 |
| Water equivalents | 1m ³ TES=1m ³ water | 1m ³ TES=1m ³ water | 3-5m ³ TES=1m ³ water | 2-5m ³ TES=1m ³ water |
| Geological requirements | Stable ground conditions. Preferably no groundwater. 5-15m deep. | Stable ground conditions. Preferably no groundwater. 5-15m deep. | Drillable ground. High heat capacity. High thermal conductivity. Low hydraulic conductivity. Groundwater flow <1m/s. 30-100m deep. | High yield aquifer. |
| Application | Short-term/diurnal TES, buffer TES. | Long-term/seasonal TES for production higher than 20.000 MWh/year. Short term TES for large TES. | Long-term/seasonal TES for DH plants production higher than 20.000 MWh/year. | Long-term/seasonal heat and cold TES. |
| Storage temperatures [°C] | 5 to 95 | 5 to 95 | 5 to 90 | 7 to 18 |
| Specific investment cost [€/m ³ water equivalent] | 110-200€/m ³ (if > 2.000m ³) | 20-40€/m ³ (if > 50.000m ³) | 20-40€/m ³ (if > 50.000m ³ water equivalent including buffer tank) | 50-60€/m ³ (cost depends on charge capacity rather storage capacity) |
| Advantages | High charge/discharge capacity. | High charge/discharge capacity. Low investment cost. | Most underground properties are suitable. | Provides heat and cold TES. Many geologically suitable sites. |
| Disadvantages | High specific investment cost | Large area requirements | Low charge/discharge capacity (potential need of a buffer tank) | Low temperatures and temperature differences |

2.3. Network design

Compared with traditional district heating systems, LTDH and ULTDH have lower network temperatures that reduce differential pressure in the network, which increases needed pumping power to keep water flow at desired levels. However, this increase in pumping power is negligible compared to heat savings [11].

While designing these new networks, one must consider simultaneously factor to account for DHW consumption at different consumer substations at the same time. That increases the needed heat supply of the network and its hydraulic load. The network needs to be designed to maintain predefined water velocity [4].

A network can be designed in a tree or a ring structure. The differential pressure difference between the first and the last consumer in traditional networks (tree structure) can cause insufficient heating of an end-user. To prevent that from occurring, valves are installed to increase flow resistance to keep differential pressure at the same levels at every consumer substation. To avoid pressure imbalances or valve installation in a tree structure, a ring network layout is developed. This structure achieves hydraulic balance with an equal length of pipes for each consumer. The supply line begins with a production facility and ends with the last consumer, and the return line begins with the first consumer and ends with the production facility. Twin pipes (two pipes in one casing) cannot be used in a ring structure, which slightly increases heat losses. Still, heat losses in ring structure network are lower than in tree structure network because there is no need for bypasses used to maintain network temperature by mixing supply water with the return [7]. Figure 3 shows tree and ring network layout, respectively.

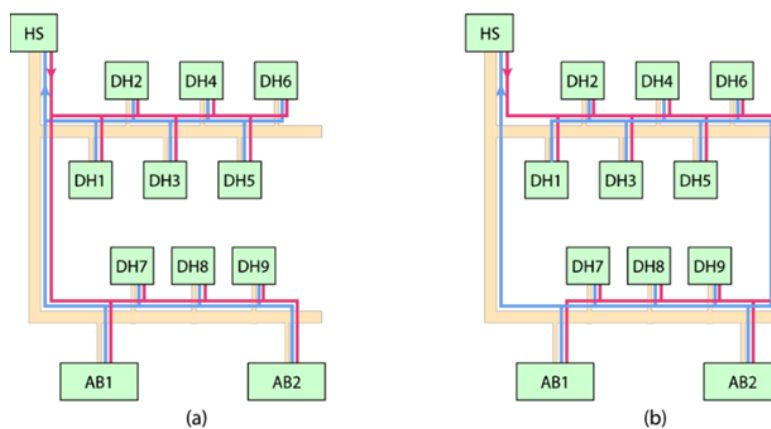

Figure 3 Tree and ring structure of a DH [7]

Due to smaller pipe dimensions and larger insulation thickness, ULTDH and LTDH networks have heat losses between 10% and 15% of total heat supplied to the network [12], which is lower than conventional network heat losses. A twin pipe or three-pipe system can be implemented in these networks. Three pipe system consists of two supply lines and one return line. One supply line operates when heat demand is low, e.g., summer, while two supply lines operate when heat demand is high. Twin pipes, as mentioned, share the same casing, which reduces heat losses. Depending on the supply line's position in the casing, heat losses can be further reduced (most heat loss reduction is achieved in cases where the supply line is placed in the middle of the casing) [4]. Different placements of supply and return lines in the twin-pipe casing are shown in Figure 4.

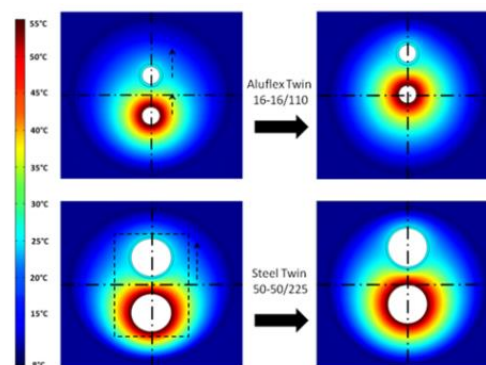

Figure 4 Twin pipe configurations [4]

Double pipe systems are used in ring structure networks, and they are considered the evolution of twin pipes. Water in the supply and return line runs in the same direction, which results in lower heat losses and pressure imbalances [4]. Figure 5 shows one double pipe network.

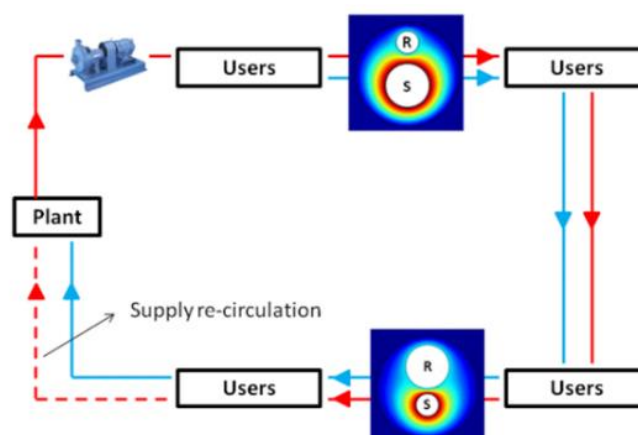

Figure 5 Double pipe network [4]

2.4. Consumer substation

At the end of each district heating system, consumers with their substations are located. In LTDH and ULTDH, space heating (at substations) is provided mostly indirectly through heat exchanges, but direct connections to the network also exist (without the transfer element). To maintain DHW temperatures at higher levels to prevent *Legionella* growth, consumer substations in LTDH networks are equipped with instantaneous heat exchangers (IHEU) or district heating storage units (DHSU). ULTDH networks for DHW preparations have heat pumps, boilers, solar collectors, or other heating units to raise the temperature.

2.4.1. Space heating

Buildings connected to ULTDH or LTDH networks are ones where thermal comfort can be achieved with lower temperatures. They are new and well-insulated objects. Existing objects can be connected to the network if they are renovated and can satisfy comfort levels with given temperatures. Planning of heat production according to the consumer needs is a shift from the traditional DH planning process where the focus was on the production facility [4].

LTDH temperatures range from 50°C to 70°C while ULTDH operates at temperatures slightly lower than 50°C. These temperatures are high enough for floor heating or low-temperature radiators. Figure 6 shows space heating temperature regimes for different network temperature regimes and heating elements.

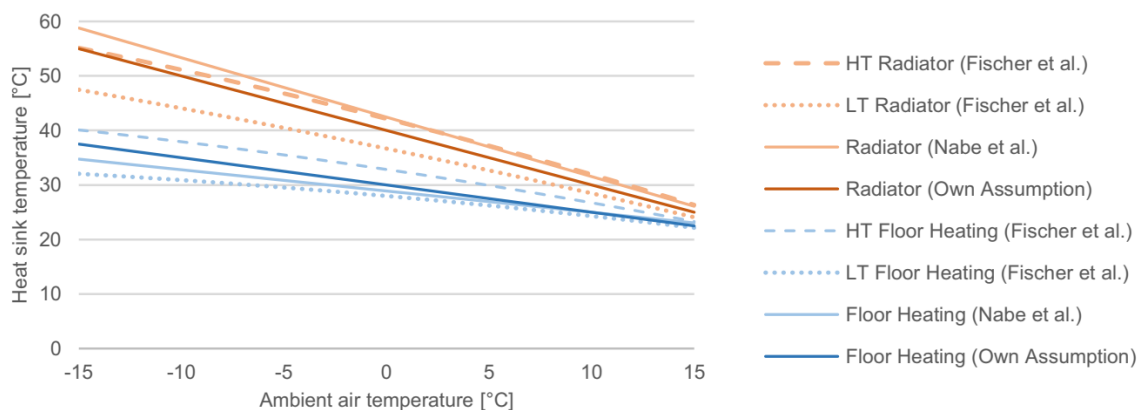

Figure 6 Space heating temperature regimes in different systems [13]

For lower pressure levels in networks, a direct connection to the household can be used. However, this is not a standard option because indirect connection enables the network and substation to be at different pressure levels. That is important because the network can operate at higher pressure levels than the substation. A drawback of indirect connections is slightly higher temperatures of networks to account for heat losses in heat exchangers, which lowers the temperature [4]. Figure 7 shows the direct connection of the LTDH network to the consumer, but the same applies to the ULTDH network (except for DHW preparation).

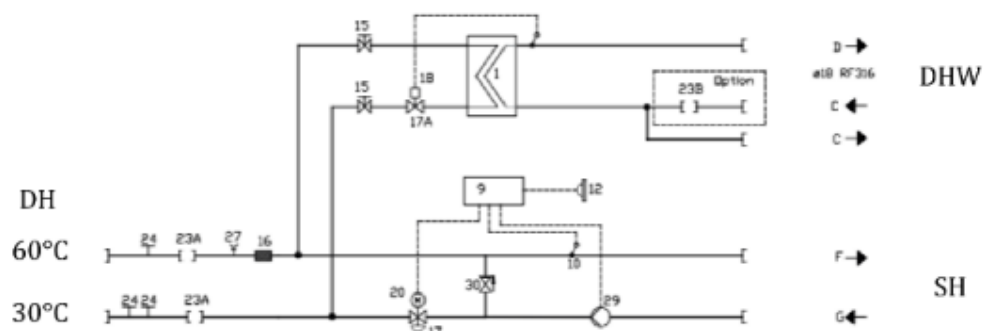

Figure 7 Direct connection of SH [14]

Indirect connection of network and consumer substation can be seen in Figure 8. It also represents the LTDH system, but it applies to ULTDH (except DHW preparation).

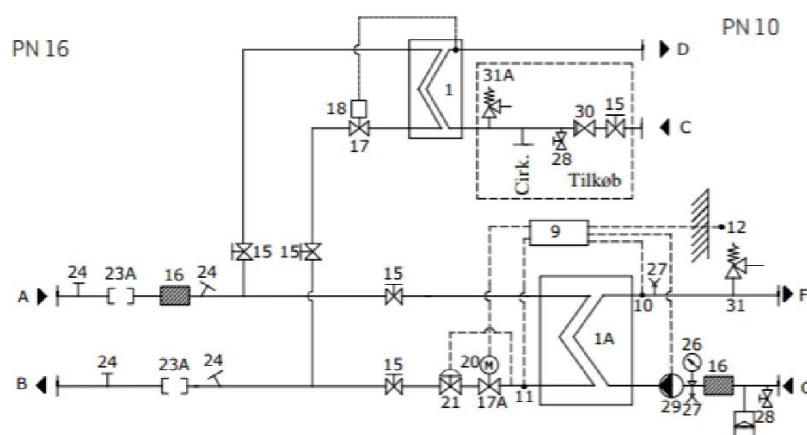

Figure 8 Indirect connection of SH [14]

2.4.2. Domestic hot water preparation

Domestic hot water must have temperatures high enough to avoid *Legionella* growth at temperatures between 30°C and 45°C. The temperature has the most crucial role in bacteria growth, but other factors, such as dimensions of the water system, hydraulic structure, pipe material and stagnation of water, can also influence it. Temperatures can be lowered in the system without *Legionella* growth, but to do so, the dwell time of water in the pipes needs to be short. Figure 9 shows *Legionella* growth rates as a function of system temperature.

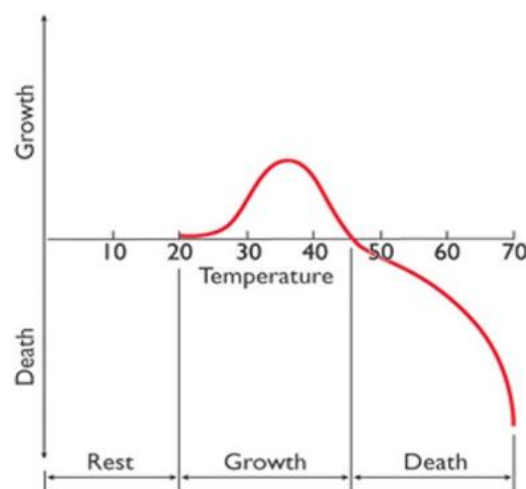

Figure 9 *Legionella* growth/decay rate [7]

Most EU countries follow European guidelines EN 806-1:2000, EN 806-2:2005 and EN 1717:2011 concerning safe DHW temperatures. These guidelines suggest that portable water temperature should not exceed 25°C and that DHW temperature should rise to 60°C 30 seconds after fully opening a tap. To reduce DHW temperature below 50°C various *Legionella* treatments can be conducted. They are classified as thermal, chemical, and physical treatments, further divided into *Legionella* killing treatments and *Legionella* growth prevention treatments. Thermal treatment consists of a short temperature rise in the system to more than 60°C or 70°C to kill *Legionella*. Chemical treatments use chemical for bacteria-killing, and physical treatments use UV light to prevent *Legionella* growth [7].

In LTDH systems, each substation is equipped with units that help maintain DHW temperatures at desirable levels. The first one is instantaneous heat exchangers (IHEU). It is dimensioned for network supply temperatures between 50°C and 55°C, used to produce DHW at a temperature of 47°C. Because of the low-temperature difference at these exchangers, they need to be highly efficient. The main components of the IHEU unit are highly efficient HEX, bypass, controller and sensor to keep supply temperature at desirable levels by recirculating supply water directly into a return [7]. One IHEU is shown in Figure 10.

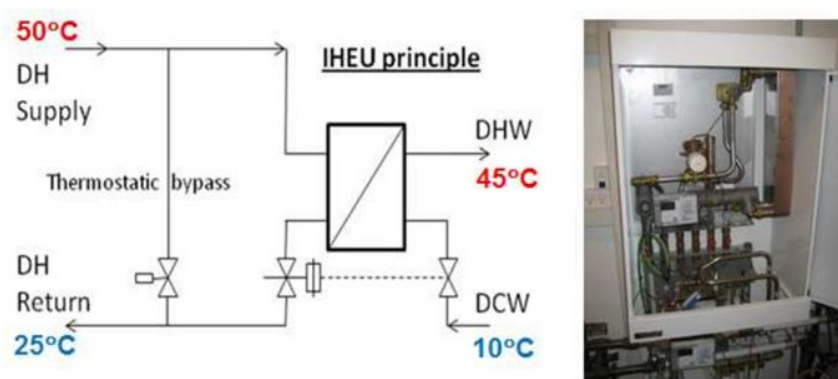

Figure 10 Instantaneous heat exchanger unit [7]

Another way of preparing DHW at desirable temperatures in LTDH is with a district heating storage unit (DHSU). In traditional district heating systems, similar tanks were placed on the secondary side of the network (consumer side). With the relocation to the primary side (network side) and enlargement of a tank, temperatures can be maintained at desired levels for DHW preparation in LTDH. The unit consists of a storage tank, heat exchanger, pump, and controller. It supplies DHW at a temperature of 45°C, with a network supply of 50°C. When there is a need for DHW, water from the tank is discharged from the bottom, and it circulates through HEX to prepare DHW. Tank is starting to charge with supply water when the water temperature at 1/3 of a tank drops below the set temperature, e.g., 50°C. Figure 11 shows DHSU.

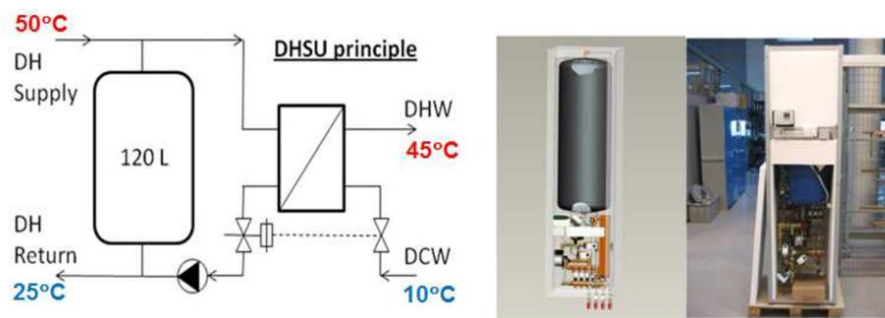

Figure 11 District heating storage unit [7]

When IHEU and DHSU are compared, it can be noticed that tanks shave peak heat load and reduce pipe dimensions. On the other hand, IHEUs are a cost-effective solution that better extract heat from supply water than DHSU but with larger pipe dimensions which increase heat losses. Despite the increase in losses, they are still considered negligible compared to conventional units [4].

When the LTDH network is connected to multi-storey buildings, the DHW system is autonomous, and each apartment has its separate DHW preparation unit. All requirements for DHW in single units apply in that case, too: higher temperatures, elimination of any circulation, small dimensions (below 3L) of a system to prevent bacteria growth. That differs from the traditional system where the DHW unit was located at one place for the whole building. These old systems had a problem maintaining hygiene, heat consumption metering for each apartment, and sometimes covering heat demand. Multi-storey building DHW installation is showed in Figure 12.

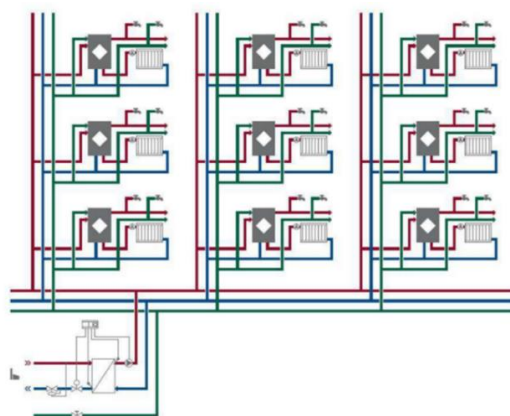

Figure 12 Apartment DHW units in multi-storey building [7]

ULTDH networks have lower network supply temperatures which need an extra booster heating unit for DHW preparation. For that purpose, electric heaters can be used, but the most used solution are heat pumps. These booster heat pumps can be on the primary side to fill the water tank to prepare DHW when needed. Figure 13 shows booster HP on the primary side.

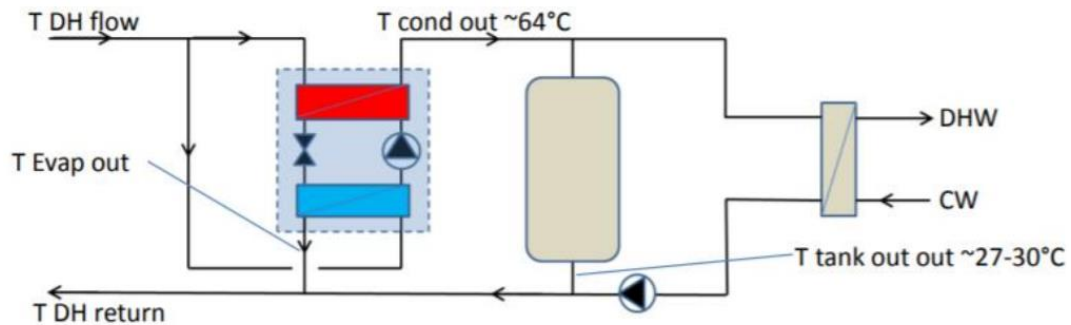

Figure 13 Booster HP with DH storage on the primary side [14]

If booster heat pumps are located on the secondary (consumer) side, they can be connected in parallel or series with space heating. In a parallel connection, DHW flow is independent of the space heating. Return from heating is used as a heat source for the heat pump. Figure 14 shows the booster heat pump for DHW on the secondary side, connected in parallel with heating. Figure 15 shows the same booster HP but in serial connection to space heating.

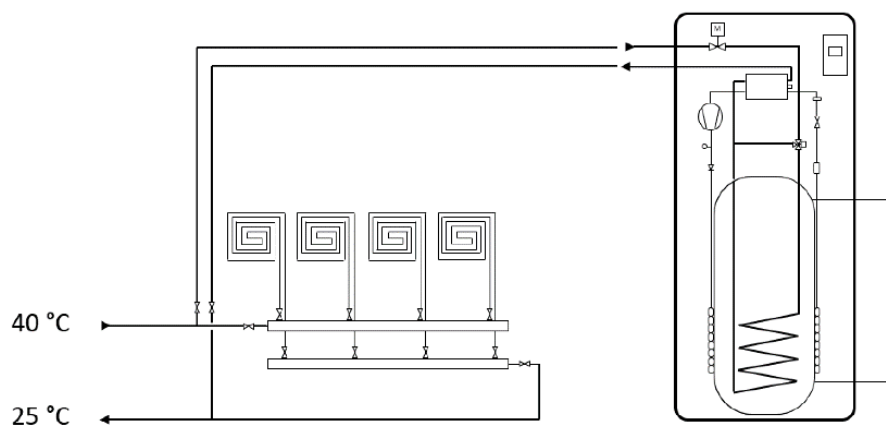

Figure 14 Booster HP for DHW (parallel connection to heating) [14]

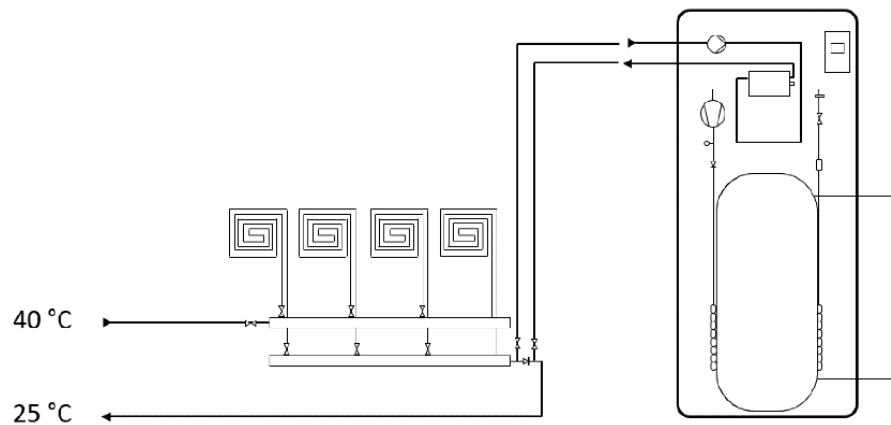

Figure 15 Booster HP for DHW (serial connection to heating) [14]

Booster HPs on the secondary side have three different modes of operation. In the first mode, ULTDH is used directly to preheat DHW through the coil. When the temperature starts to increase, the second mode, the water-to-water heat pump circuit, is activated. In this phase, heat is transferred directly from the coil and HP to the domestic hot water. The third mode presents a phase when heat from the coil is completely extracted, and only HP is used for DHW preparation. All three modes are presented in Figure 16, respectively.

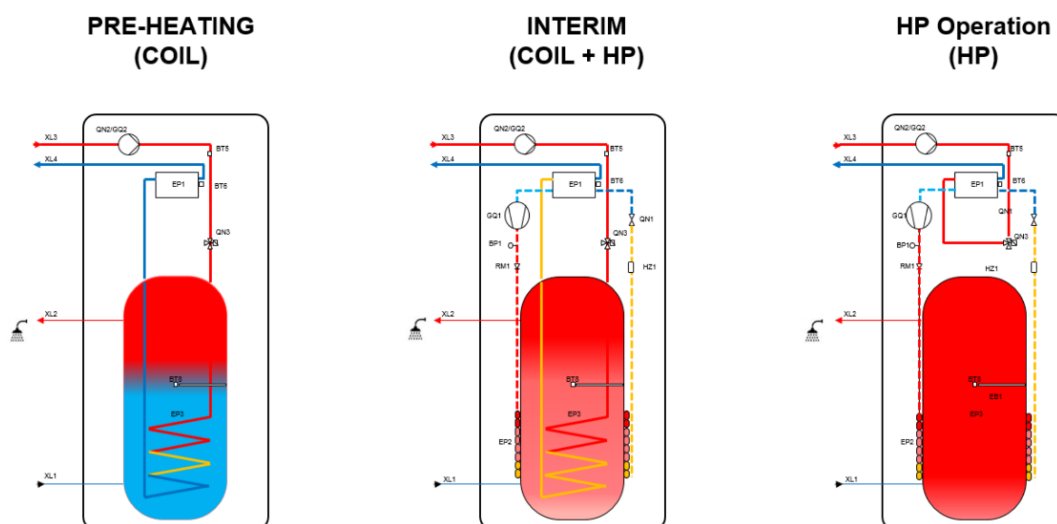

Figure 16 Operation modes of booster HP on the secondary side [14]

As well as water to the water heat pump, air to a water heat pump can also be used. Figure 17 shows the usage of an air heat pump for DHW preparation. In this case, the coil connected to the ULTDH preheats the water in the tank.

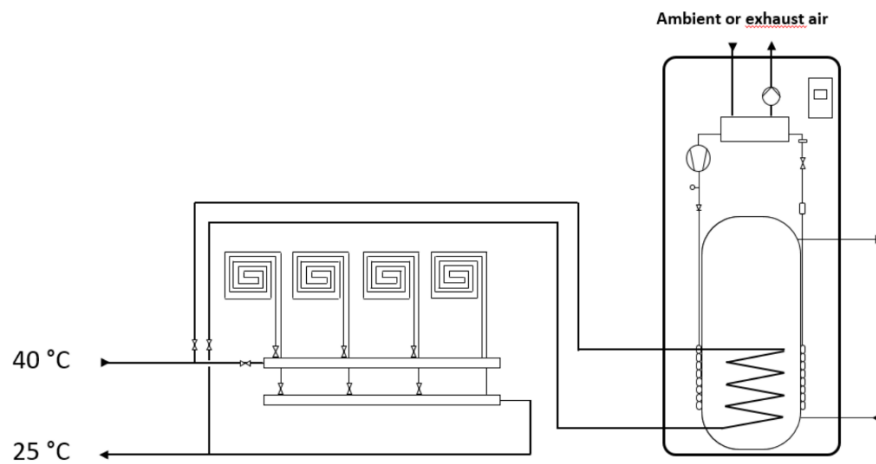

Figure 17 Air booster HP on the secondary side [14]

3. METHOD

This thesis aimed to determine the cost and benefits of integrating ULTDH and LTDH networks and compare them to individual natural gas boiler heating. The main motivation and guidance for model development was the paper: *Economic feasibility of ultra-low temperature district heating systems in the newly built area supplied by renewable energy*, published in *Energy* [15]. Some method modifications were made, and data concerning Croatia was used. This paper was upgraded since additional results have been acquired, such as primary energy and carbon emission factors which are then compared to individual solutions.

3.1. Heat demand

Initial data for the model is specific domestic hot water demand, q_{DHW} and district area $A_{district}$. Those values were kept constant throughout the whole model. However, plot ratio, the ratio of buildings area $A_{buildings}$ and total district area $A_{district}$, given by the equation (1):

$$\epsilon = \frac{A_{buildings}}{A_{district}} \rightarrow A_{buildings} = \epsilon \cdot A_{district} \quad (1)$$

were varied for each scenario (from 0,2, representing the rural area, to 2,0, representing the urban, densely populated area, in steps of 0,2), which resulted in different total annual domestic hot water needs $Q_{tot,DHW}$ given by the equation (2):

$$Q_{tot,DHW} = q_{DHW} \cdot A_{buildings} \quad (2)$$

Specific hot water demand q_{DHW} and space heating share s_H (which was varied between 0,1, representing highly efficient buildings with low space heating needs to 0,8, in steps of 0,1) used to calculate specific annual heat demand q_S (expressed as a sum of specific space heating demand, q_{SH} and specific domestic hot water demand, q_{DHW}) in equation (3):

$$q_{tot} = q_{DHW} + q_{SH} = \frac{1}{1 - s_H} \cdot q_{DHW} \quad (3)$$

Total specific heat demand, q_S , was multiplied with total buildings area $A_{buildings}$ to calculate the total annual heat demand Q_{tot} of a district in equation (4):

$$Q_{tot} = q_{tot} \cdot A_{buildings} \quad (4)$$

From the total annual heating demand Q_{tot} and total annual domestic hot water demand $Q_{tot,DHW}$, one can calculate the total annual space heating demand $Q_{tot,SH}$ from equation (5):

$$Q_{tot,SH} = Q_{tot} - Q_{tot,DHW} \quad (5)$$

3.2. Network heat losses and pumping power

Heat losses are an important factor in each cost-benefit analysis of any district heating systems. Even though heat losses are lower in ULTDH and LTDH networks than in conventional networks, they can still influence network profitability. To assess heat losses, linear heat density demand (LHDD), q_l must be known. In determining LHDD, the following approach is used [16]. The first step is to determine the effective width of a network, w as a function of plot ratio ϵ , using equation (6) described in literature [17]:

$$w = 61,8 \cdot \epsilon^{-0,15} \quad (6)$$

After effective width is found, linear heat density demand q_l is calculated in (7) from [15]:

$$q_l = \frac{Q_{tot}}{L} = q_{tot} \cdot \epsilon \cdot w \quad (7)$$

After determining LHDD with specific total heat demand q_{tot} , plot ratio ϵ and effective width w , trench length L can be calculated with equation (8):

$$L = \frac{Q_{tot}}{q_l} \quad (8)$$

Average pipe diameter in district heating network d_a in metres, was determined with known linear heat density demand from equation (9) from [16]:

$$d_a = 0,0486 \cdot \ln\left(\frac{Q_{tot}}{L}\right) + 0,0007 \quad (9)$$

Finally, to calculate heat losses in the network, heat loss data from Denmark existing district heating networks was used [18] to determine the correlation between LHDD and heat losses shown in Figure 18.

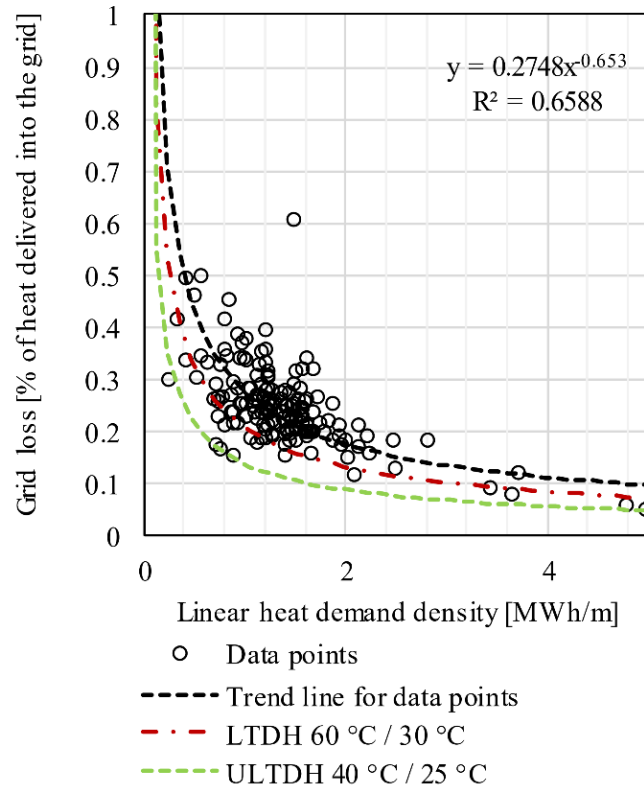

Figure 18 Heat loss data from existing DH networks in Denmark [15]

To calculate annual heat losses, equation (10), from [15] is used:

$$\frac{Q_{loss}}{Q_{tot}} = 0,2748 \cdot q_l^{-0,653} \cdot \frac{T_{supply} + T_{return} - 2 \cdot T_{ground}}{\bar{T}_{supply} + \bar{T}_{return} - 2 \cdot T_{ground}} \quad (10)$$

In this equation, $\bar{T}_{supply} = 73,71^\circ\text{C}$ and $\bar{T}_{return} = 40,52^\circ\text{C}$ are weighted average supply and return temperature of the Danish systems taken from a database.

Pumping power depends on network layout, and estimation of pumping power without knowing network details is not precise. However, pumping power can be calculated with volume flow \dot{V} and pressure drop in the system Δp_{DH} . Volume flow can be calculated with equation (11):

$$\dot{V} = \frac{\left(\frac{Q_{tot,delivered}}{8.760}\right)}{c_{p,H_2O} \cdot (T_{supply} - T_{return}) \cdot \rho_{H_2O}} \quad (11)$$

Where $Q_{tot,delivered}$ represents total annual heat delivered to the network (total heat demand and network heat losses), c_{p,H_2O} represents water isobaric specific heat, ρ_{H_2O} represents water density and T_{supply} and T_{return} represent supply and return network temperatures, respectively.

Pressure drop in the network, $\Delta p_{network}$ was assumed to be 100 Pa/m [15], and pressure drop at consumer substations $\Delta p_{substations}$ was assumed to be 100.000 Pa [19]. Overall pressure drop, Δp_{DH} in the system can be calculated with equation (12):

$$\Delta p_{DH} = \Delta p_{network} + \Delta p_{substations} = 2 \cdot L \cdot 100 + \Delta p_{substations} \quad (12)$$

Necessary annual energy for pumping W_{pump} is calculated with equation (13):

$$W_{pump} = \Delta p_{DH} \cdot \dot{V} \cdot \eta_{pump} \cdot 8.760 \quad (13)$$

Where η_{pump} is pump efficiency, in this case 0,8 [20].

3.3. Heat pumps coefficients of performances

Heat pumps coefficients of performances (COP) were calculated for each hour of the year for every heat pump. For this purpose, the Lorenz coefficient was used as described in [21]. Figure 19 shows a simple one-stage heat pump process on the left and a temperature-heat diagram of that same process on the right.

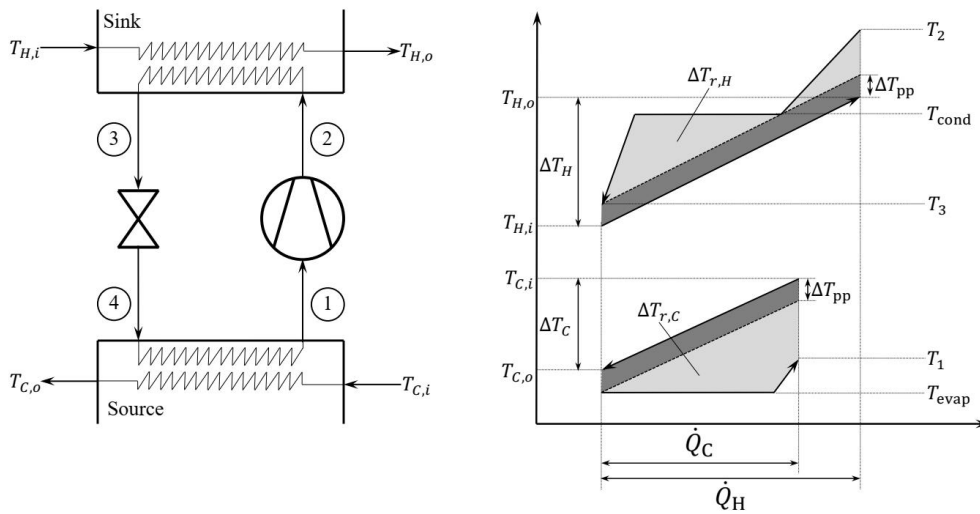

Figure 19 Cycle of a simple heat pump process and its heat load diagram [21]

Temperature $T_{C,i}$ represents inlet temperature of heat source in heat pump evaporator, while $T_{C,o}$ represents its outlet temperature, which is lower than inlet temperature because of cooling. The temperature difference of these two temperatures is calculated with equation (14):

$$\Delta T_C = T_{C,i} - T_{C,o} \quad (14)$$

Temperature $T_{H,i}$ represents inlet temperature of a sink medium in heat pump condenser, a medium which enters the condenser at that temperature, exits it with outlet temperature $T_{H,o}$. The outlet temperature is higher than the inlet temperature for the sink medium. The temperature difference between outlet and inlet temperature of a sink medium is calculated with equation (15):

$$\Delta T_H = T_{H,o} - T_{H,i} \quad (15)$$

The unit for temperature difference calculation is irrelevant, but the temperature must be converted to Kelvins for the following equations. To calculate Lorenz COP, the mean temperature of a sink \bar{T}_H from the equation (16) needs to be found:

$$\bar{T}_H = \frac{\Delta T_H}{\ln \left(\frac{T_{H,o}}{T_{H,i}} \right)} \quad (16)$$

Besides the sink medium, the mean temperature of a source \bar{T}_C needs also to be found from equation (17):

$$\bar{T}_C = \frac{\Delta T_C}{\ln \left(\frac{T_{C,o}}{T_{C,i}} \right)} \quad (17)$$

For cases, where the temperature of a source medium does not change after passing through the heat pump evaporator, \bar{T}_C represent only source temperature in Kelvin degrees. The difference between the mean temperatures of the heat sink and the heat source is referred to as temperature lift calculated with the following equation (18):

$$\Delta \bar{T}_{lift} = \bar{T}_H - \bar{T}_C \quad (18)$$

In the end, the Lorenz coefficient of performance, COP_{Lorenz} can be calculated as the ratio of the mean temperature of the heat sink \bar{T}_H and the mean temperature lift $\Delta\bar{T}_{lift}$ showed in equation (19):

$$COP_{Lorenz} = \frac{\bar{T}_H}{\bar{T}_H - \bar{T}_C} = \frac{\bar{T}_H}{\Delta\bar{T}_{lift}} \quad (19)$$

To avoid model faultily COP_{Lorenz} results in few cases, where the mean temperature of a sink is higher than the mean temperature of a source (summer hours), the mean temperature lift $\Delta\bar{T}_{lift}$ has been limited with a minimum value of five.

After Lorenz coefficient of performance was determined for each hour COP_{Lorenz} , real COP value needed to be determined using equation (20):

$$COP = \eta_{Lorenz} \cdot COP_{Lorenz} \quad (20)$$

Where η_{Lorenz} is Lorenz efficiency, which depends on refrigerant used in heat pump and mean temperature lift $\Delta\bar{T}_{lift}$. As in the mentioned paper, ammonia was used as a refrigerant for large heat pumps, while isobutane was used for decentralised units [15]. Figure 20 shows Lorenz efficiency curves for isobutane and ammonia.

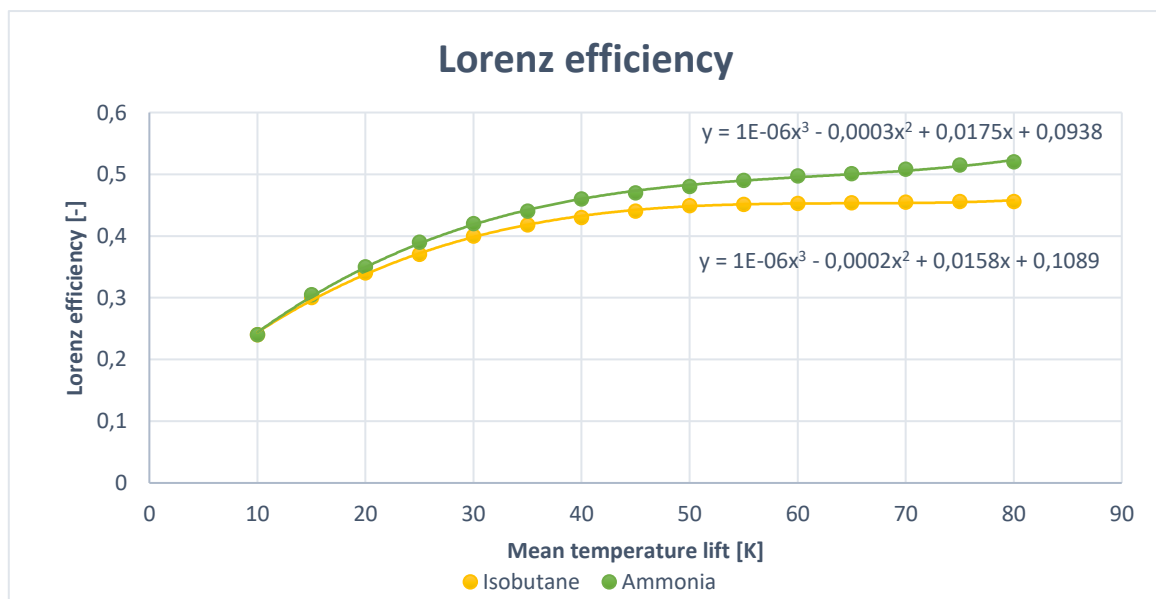

Figure 20 Lorenz efficiency curves [21]

After final values of the coefficient of performances were calculated for each hour of the year, a reduction for COP for air source heat pumps was applied to account for electricity loss due to defrosting needs of these units at outdoor temperatures below 7°C. The reduction factor of air source heat pump COP was taken as 0,84 [22].

3.4. Systems seasonal coefficient of performance

In LTDH cases, total heat production was in the central unit. In ULTDH cases, a portion of the heat demand was produced in the central unit, and the rest was produced at decentral units. In ULTDH cases with air source heat pump at consumer substations, ASHPs at consumer substations covered only domestic hot water demand, while the central unit produced heat for heating. In ULTDH with micro heat pumps and ULTDH with booster heat pumps at a building level, the heat produced from the central unit in each hour was calculated with equation (21):

$$\dot{Q}_{central} = \dot{Q}_{tot,delivered} - \frac{\dot{Q}_{tot,DHW}}{COP_{decentral}} \quad (21)$$

Where $\dot{Q}_{tot,delivered}$ is total heat supplied to the network in a given hour (SH demand, DHW demand and heat losses), $\dot{Q}_{tot,DHW}$ is total DHW demand in a given hour and $COP_{decentral}$ is decentral unit COP (either booster heat pump or micro heat pump).

After calculation of COP value and heat production of each unit for each hour and each heat pump, hourly electricity consumption could be calculated with equation (22):

$$COP = \frac{\dot{Q}}{\dot{W}} \rightarrow \dot{W} = \frac{\dot{Q}}{COP} \quad (22)$$

Total annual electricity consumption of district heating system is the sum of annual central unit electricity consumption $W_{central}$, annual pump electricity consumption W_{pump} , and, if present, annual decentral units electricity consumption $W_{decentral}$ as shown in equation (23):

$$W_{tot} = W_{central} + W_{pump} + W_{decentral} \quad (23)$$

System seasonal coefficient of performance is then calculated as a ratio of total heat delivered to the customers, Q_{tot} and total electricity consumption of a system in one year, W_{tot} as in (24):

$$COP_{system,seasonal} = \frac{Q_{tot}}{W_{tot}} \quad (24)$$

3.5. Levelized cost of heat, carbon emission, and primary energy factors

Levelized cost of heat (*LCOH*) was calculated as the sum of *CAPEX* and *OPEX* divided by delivered heat to the consumers. *CAPEX* was calculated using equation (25):

$$CAPEX = CRF \cdot I = \frac{i \cdot (1 + i)^n}{(1 + i)^n - 1} \cdot I \quad (25)$$

Where *CRF* is capital recovery factor [23] calculated for each part of investment separately, taking into account lifetime *n* and discount rate *i* suggested by Croatian National Bank [24]. *I* represents investment cost of certain part of a system.

OPEX was calculated as a sum of all *O&M* costs added to total electricity cost or total gas consumption cost. *OPEX* is shown in equation (26):

$$OPEX = \sum_{i=1}^N O\&M_i + (E\text{or}G) \quad (26)$$

LCOH value was then calculated as a ratio of *CAPEX* and *OPEX* sum and total heat delivered to the consumers in a year, as in equation (27):

$$LCOH = \frac{CAPEX + OPEX}{Q_{tot}} \quad (27)$$

Primary energy factor $f_{prim,scenario}$ was calculated as a ratio of primary energy used over total heat delivered Q_{tot} to the consumers in a year. Firstly, total electricity W_{tot} or gas T_{tot} consumption was converted to primary energy. The result was then divided with total heat consumption of consumers Q_{tot} , as in equation (28):

$$f_{prim,scenario} = \frac{(W_{tot\text{or}T_{tot}}) \cdot f_{prim}}{Q_{tot}} \quad (28)$$

A similar procedure has taken place while determining the CO_2 factor (carbon emission factor). Electricity W_{tot} or gas T_{tot} consumption was multiplied with CO_2 factors f_{CO_2} . Those values are at the end divided by the total heat consumption of consumers Q_{tot} , as in equation (29):

$$f_{CO_2,scenario} = \frac{(W_{tot\text{or}T_{tot}}) \cdot f_{CO_2}}{Q_{tot}} \quad (29)$$

4. CASE STUDY

Four scenarios were developed:

- LTDH network (LTDH).
- ULTDH network with booster heat pumps at the building level (ULTDH_Booster).
- ULTDH network with micro heat pumps in each apartment (ULTDH_Micro).
- ULTDH network where central heat source covers space heating (SH) demand and DHW demand is covered through air source heat pumps (ASHP) at the building level (ULTDH_Air).

For each scenario heat source for the central heat pump was varied. District heating systems were supplied by a central air source heat pump, groundwater heat pump, excess heat pump, or heat exchangers supplied with excess heat. The last central supply option is an ideal scenario because it is hard to find year-round excess heat at high enough temperatures. Figure 21 presents variations of consumer substations. Figure 21 (a) represents the LTDH system with heat exchangers at the consumer substation. Figure 21 (b) depicts a ULTDH system with a heat exchanger for space heating and booster heat pump on the primary side for DHW demand of a whole building. Here supply from the network is used as a source and sink for the heat pump. Figure 21 (c) represents the ULTDH case where the network is used to cover space heating demand while air source heat pumps cover DHW demand. Figure 21 (d) presents the ULTDH network with micro heat pumps in each apartment for DHW preparation.

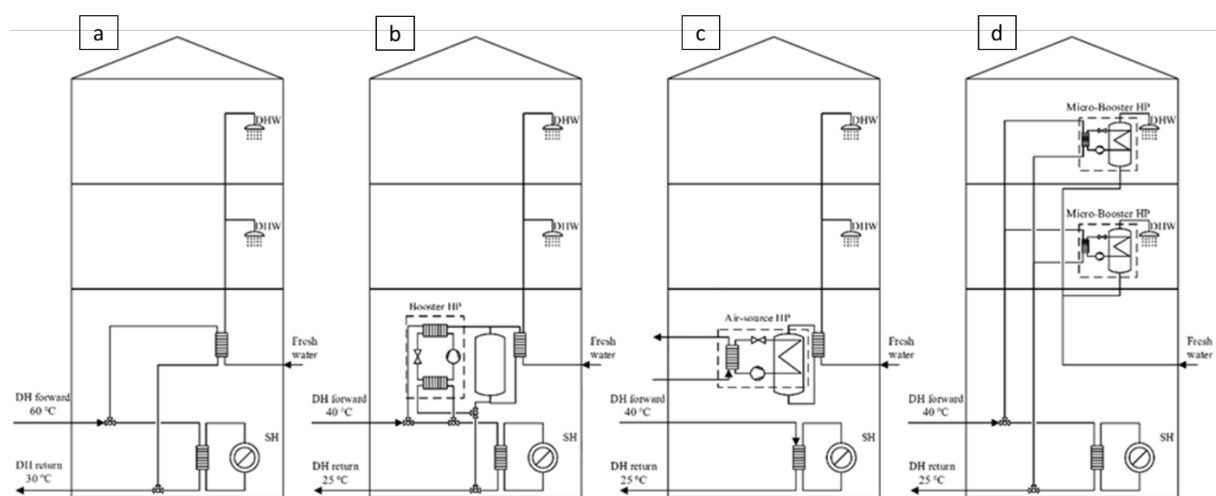

Figure 21 Four scenarios considered in the calculation [15]

LTDH supply and return temperatures were 60°C and 30°C, respectively, while supply temperature in ULTDH was 40°C and return temperature was 25°C. Temperatures in LTDH systems are high enough for DHW preparation, and ULTDH systems have booster heat pumps to achieve the needed 60°C DHW temperature. District size was roughly 100.000 m², which is the average size of a neighbourhood in Zagreb. Specific domestic hot water demand was 26 kWh/m²/a, calculated from given data [13] (value for Croatia).

Levelized cost of heat (LCOH), primary energy factor and CO₂ factor were calculated for each of the twenty cases and the two control cases with individual gas boiler ASHP heating. The aim was to show how these system parameters change with different plot ratios and space heating shares.

Figure 22 shows the LTDH system from a central unit to the consumer substation.

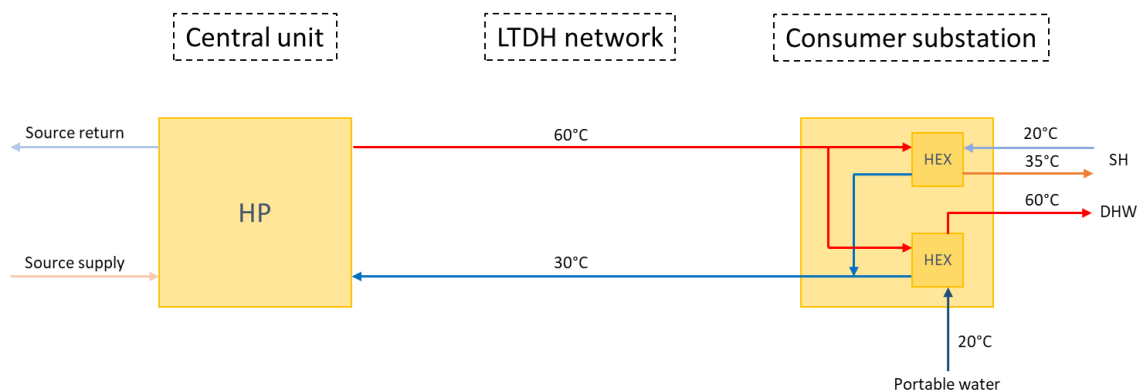

Figure 22 LTDH network

Figure 23 depicts the ULTDH network with booster HP for DHW preparation of a whole building.

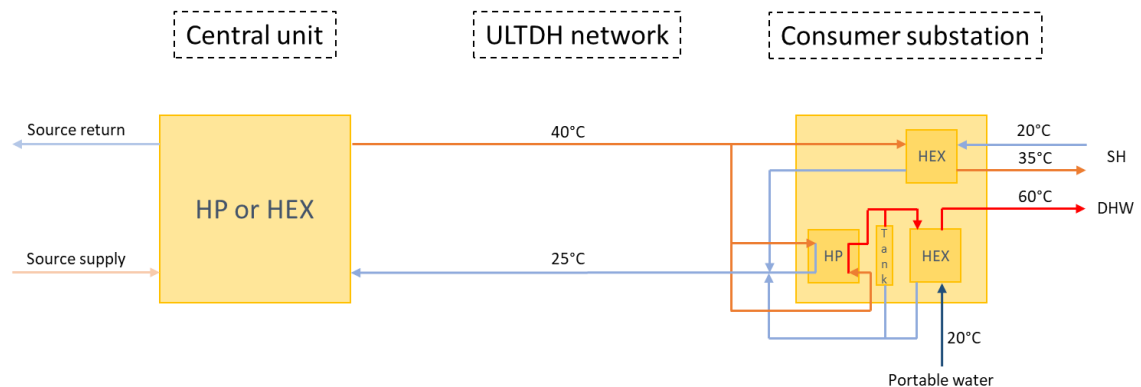

Figure 23 ULTDH network with booster HP at consumer substation

Figure 24 shows the ULTDH network with micro-HP for DHW preparation. It must be noted that in this case, a micro heat pump is in each apartment.

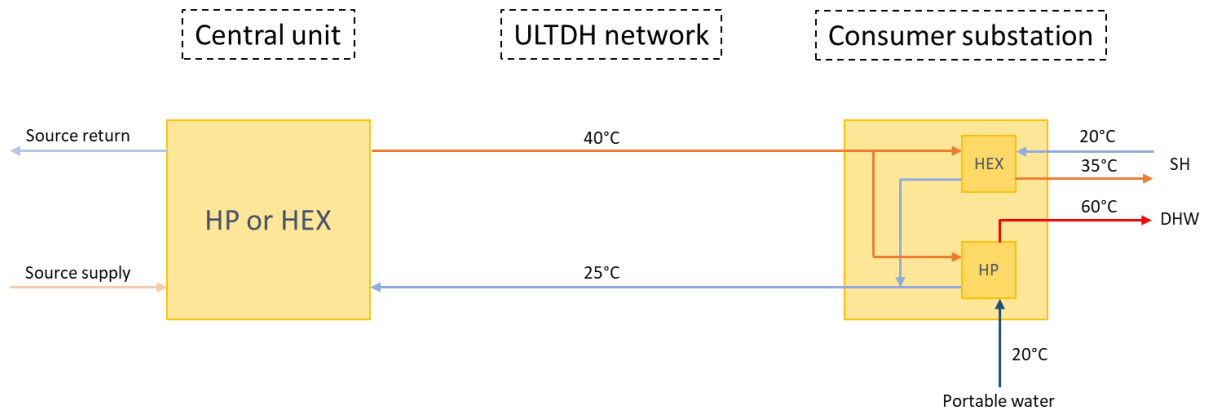

Figure 24 ULTDH network with micro-HP at consumer substation

In Figure 25 ULTDH network with air source heat pump for DHW preparation is depicted.

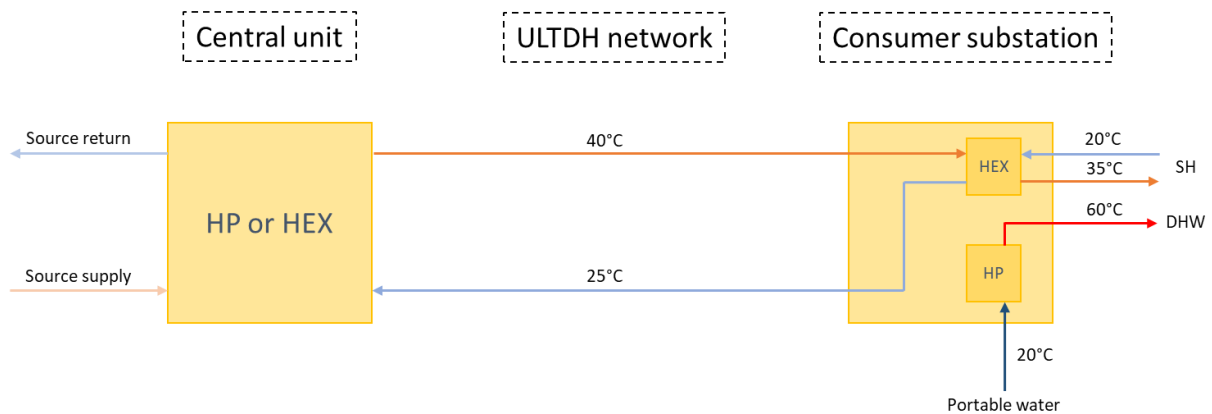

Figure 25 ULTDH network with ASHP at consumer substation

Table 3 shows all scenarios and their characteristics regarding network type, heat source, utilisation unit of central heat source, DHW and SH substation in a building. At the end of each row, figures that present scenarios are listed.

Table 3 Scenarios characteristics

| Scenario | Central source | Central unit | Network | SH unit | DHW unit | Figure |
|-----------------------------|----------------|--------------|---------|---------|---------------|-----------|
| LTDH_ASHP | Air | HP | LTDH | HEX | HEX | Figure 22 |
| LTDH_GWHP | Groundwater | HP | LTDH | HEX | HEX | Figure 22 |
| LTDH_EH1HP | Excess heat | HP | LTDH | HEX | HEX | Figure 22 |
| LTDH_EH2HP | Excess heat | HP | LTDH | HEX | HEX | Figure 22 |
| LTDH_EH3HP | Excess heat | HP | LTDH | HEX | HEX | Figure 22 |
| ULTDH_Booster_ASHP | Air | HP | ULTDH | HEX | HP building | Figure 23 |
| ULTDH_Booster_GWHP | Groundwater | HP | ULTDH | HEX | HP building | Figure 23 |
| ULTDH_Booster_EH1HEX | Excess heat | HEX | ULTDH | HEX | HP building | Figure 23 |
| ULTDH_Booster_EH2HP | Excess heat | HP | ULTDH | HEX | HP building | Figure 23 |
| ULTDH_Booster_EH3HP | Excess heat | HP | ULTDH | HEX | HP building | Figure 23 |
| ULTDH_Micro_ASHP | Air | HP | ULTDH | HEX | HP apartment | Figure 24 |
| ULTDH_Micro_GWHP | Groundwater | HP | ULTDH | HEX | HP apartment | Figure 24 |
| ULTDH_Micro_EH1HEX | Excess heat | HEX | ULTDH | HEX | HP apartment | Figure 24 |
| ULTDH_Micro_EH2HP | Excess heat | HP | ULTDH | HEX | HP apartment | Figure 24 |
| ULTDH_Micro_EH3HP | Excess heat | HP | ULTDH | HEX | HP apartment | Figure 24 |
| ULTDH_Air_ASHP | Air | HP | ULTDH | HEX | ASHP building | Figure 25 |
| ULTDH_Air_GWHP | Groundwater | HP | ULTDH | HEX | ASHP building | Figure 25 |
| ULTDH_Air_EH1HEX | Excess heat | HEX | ULTDH | HEX | ASHP building | Figure 25 |
| ULTDH_Air_EH2HP | Excess heat | HP | ULTDH | HEX | ASHP building | Figure 25 |
| ULTDH_Air_EH3HP | Excess heat | HP | ULTDH | HEX | ASHP building | Figure 25 |
| Individual_ASHP | - | - | - | HP | HP | - |
| Individual_GB | - | - | - | GB | GB | - |

Source temperatures for groundwater were 12°C/7°C [25]. Excess heat cases had 40°C, 30°C, and 20°C supply temperature which were cooled to 10°C in the central unit. Air was considered as an infinite heat source that does not change the temperature in the heat pump. DHW temperature is always needed to be raised to 60°C, from 20°C portable water. Detailed network temperatures are shown in Table 4.

Table 4 Temperature of LTDH and ULTDH networks [°C]

| Scenario | $T_{central,source,in}$ | $T_{central,source,out}$ | $T_{central,sink,in}$ | $T_{central,sink,out}$ | $T_{decentral,source,in}$ | $T_{decentral,source,out}$ | $T_{decentral,sink,in}$ | $T_{decentral,sink,out}$ |
|----------------------|-------------------------|--------------------------|-------------------------|-------------------------|---------------------------|----------------------------|-------------------------|--------------------------|
| LTDH_ASHP | Hour air temp. | Hour air temp. | Hour LTDH return temp. | Hour LTDH supply temp. | - | - | - | - |
| LTDH_GWHP | 12 | 7 | Hour LTDH return temp. | Hour LTDH supply temp. | - | - | - | - |
| LTDH_EH1HP | 40 | 10 | Hour LTDH return temp. | Hour LTDH supply temp. | - | - | - | - |
| LTDH_EH2HP | 30 | 10 | Hour LTDH return temp. | Hour LTDH supply temp. | - | - | - | - |
| LTDH_EH3HP | 20 | 10 | Hour LTDH return temp. | Hour LTDH supply temp. | - | - | - | - |
| ULTDH_Booster_ASHP | Hour air temp. | Hour air temp. | Hour ULTDH return temp. | Hour ULTDH supply temp. | Hour ULTDH supply temp. | Hour ULTDH return temp. | 20 | 60 |
| ULTDH_Booster_GWHP | 12 | 7 | Hour ULTDH return temp. | Hour ULTDH supply temp. | Hour ULTDH supply temp. | Hour ULTDH return temp. | 20 | 60 |
| ULTDH_Booster_EH1HEX | 40 | 10 | Hour ULTDH return temp. | Hour ULTDH supply temp. | Hour ULTDH supply temp. | Hour ULTDH return temp. | 20 | 60 |
| ULTDH_Booster_EH2HP | 30 | 10 | Hour ULTDH return temp. | Hour ULTDH supply temp. | Hour ULTDH supply temp. | Hour ULTDH return temp. | 20 | 60 |
| ULTDH_Booster_EH3HP | 20 | 10 | Hour ULTDH return temp. | Hour ULTDH supply temp. | Hour ULTDH supply temp. | Hour ULTDH return temp. | 20 | 60 |
| ULTDH_Micro_ASHP | Hour air temp. | Hour air temp. | Hour ULTDH return temp. | Hour ULTDH supply temp. | Hour ULTDH supply temp. | Hour ULTDH return temp. | 20 | 60 |
| ULTDH_Micro_GWHP | 12 | 7 | Hour ULTDH return temp. | Hour ULTDH supply temp. | Hour ULTDH supply temp. | Hour ULTDH return temp. | 20 | 60 |
| ULTDH_Micro_EH1HEX | 40 | 10 | Hour ULTDH return temp. | Hour ULTDH supply temp. | Hour ULTDH supply temp. | Hour ULTDH return temp. | 20 | 60 |
| ULTDH_Micro_EH2HP | 30 | 10 | Hour ULTDH return temp. | Hour ULTDH supply temp. | Hour ULTDH supply temp. | Hour ULTDH return temp. | 20 | 60 |
| ULTDH_Micro_EH3HP | 20 | 10 | Hour ULTDH return temp. | Hour ULTDH supply temp. | Hour ULTDH supply temp. | Hour ULTDH return temp. | 20 | 60 |
| ULTDH_Air_ASHP | Hour air temp. | Hour air temp. | Hour ULTDH return temp. | Hour ULTDH supply temp. | Hour air temp. | Hour air temp. | 20 | 60 |
| ULTDH_Air_GWHP | 12 | 7 | Hour ULTDH return temp. | Hour ULTDH supply temp. | Hour air temp. | Hour air temp. | 20 | 60 |
| ULTDH_Air_EH1HEX | 40 | 10 | Hour ULTDH return temp. | Hour ULTDH supply temp. | Hour air temp. | Hour air temp. | 20 | 60 |
| ULTDH_Air_EH2HP | 30 | 10 | Hour ULTDH return temp. | Hour ULTDH supply temp. | Hour air temp. | Hour air temp. | 20 | 60 |
| ULTDH_Air_EH3HP | 20 | 10 | Hour ULTDH return temp. | Hour ULTDH supply temp. | Hour air temp. | Hour air temp. | 20 | 60 |
| Individual_ASHP | - | - | - | - | Hour air temp. | Hour air temp. | 20 | 60 |
| Individual_GB | - | - | - | - | - | - | 20 | 60 |

4.1. Input data

The model was developed according to Croatian data. Hourly temperatures were taken for average outdoor temperature in Croatia for 2018 [26]. Hourly temperature values throughout the year are shown in Figure 26.

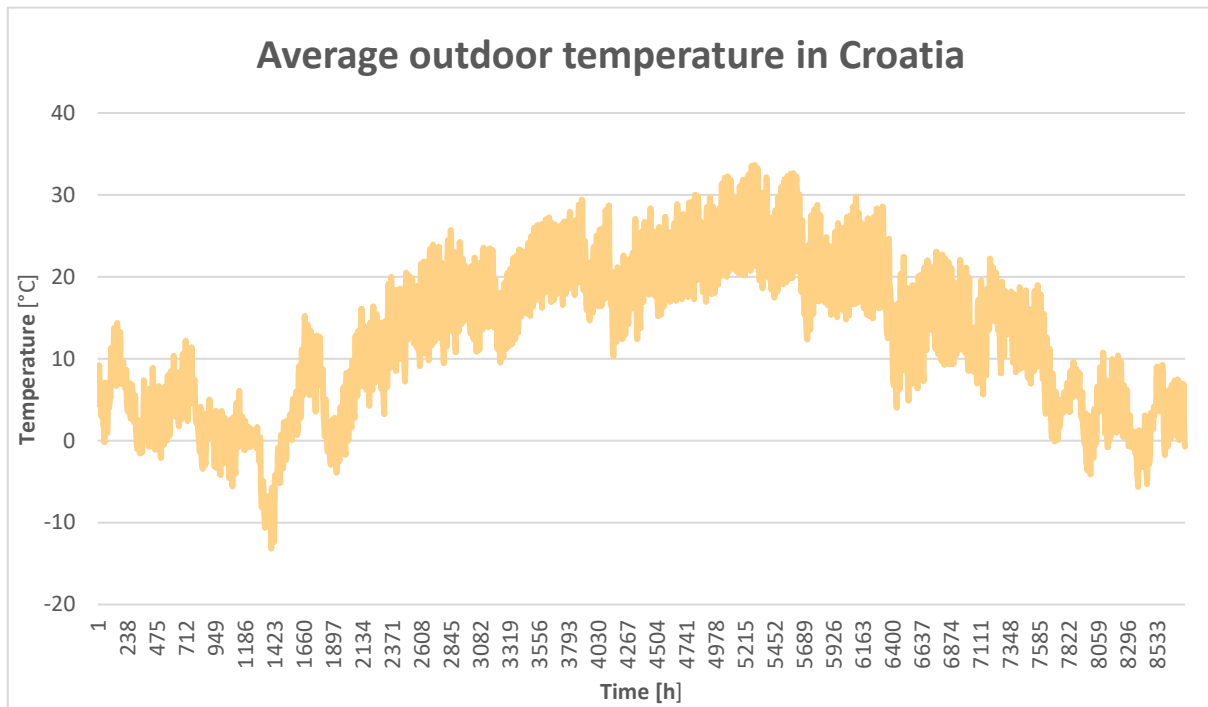

Figure 26 Average outdoor temperature in Croatia in 2018 [26]

SH and DHW demand were modelled according to the total SH and DHW demand of households in Croatia in 2018 [13]. Figure 27 shows household relative SH demand through the year. Figure 28 shows household relative domestic hot water demand throughout the year.

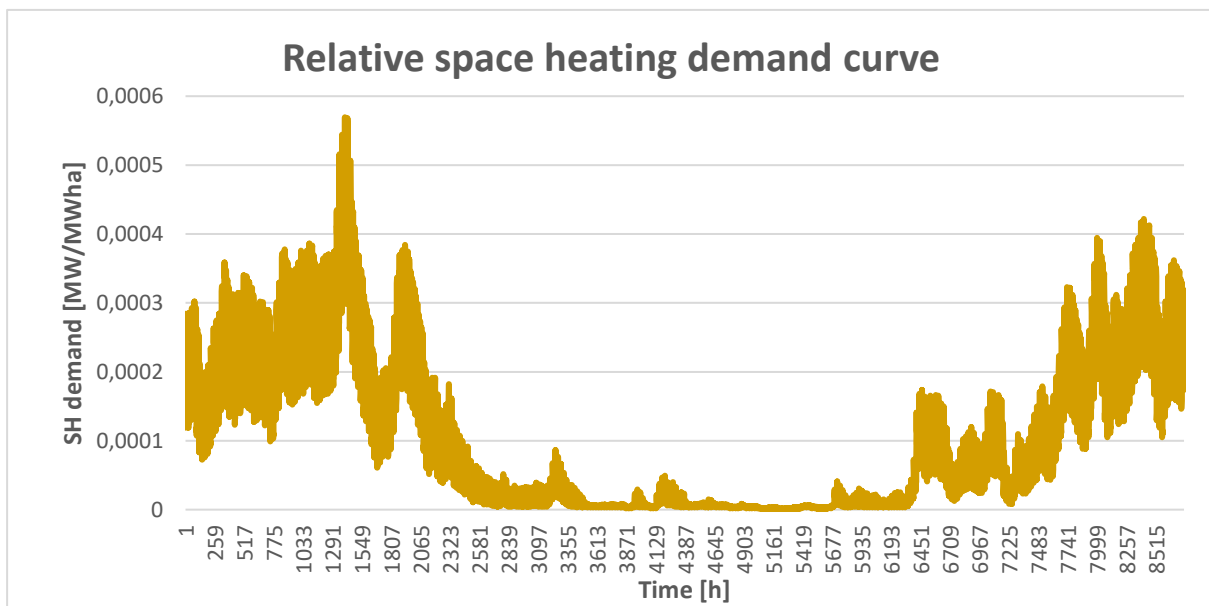

Figure 27 Relative SH demand curve for Croatia in 2018 [13]

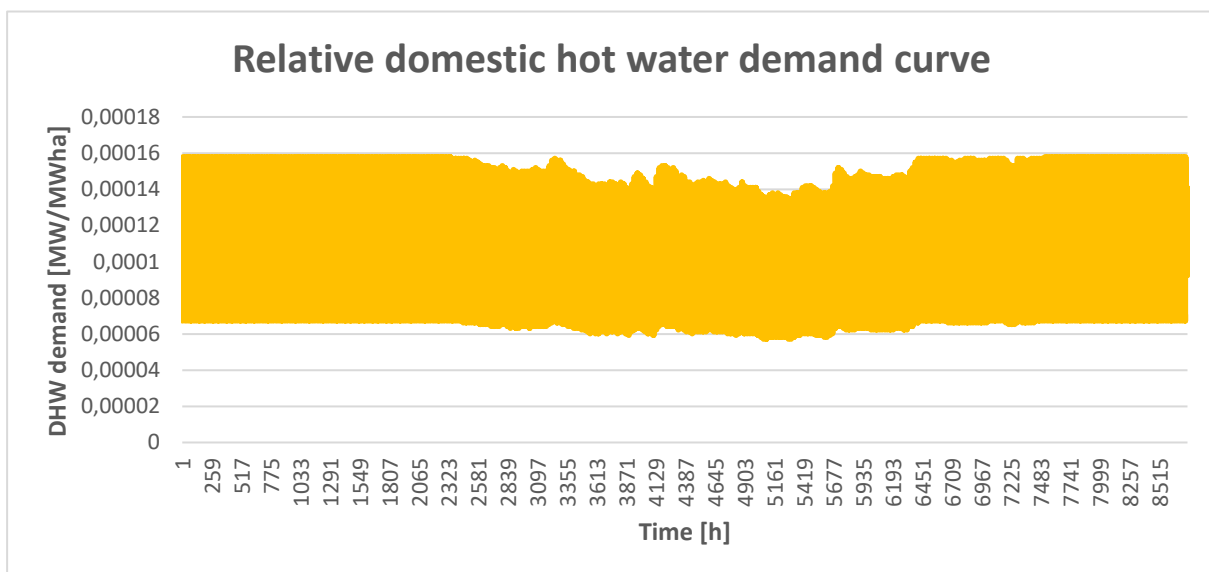

Figure 28 Relative DHW demand curve for Croatia in 2018 [13]

To determine the heat losses of a network, the heat loss distribution curve needs to be known. The curve equation that distributes heat losses over the year was calculated from the given data [27]. Because the heat losses are calculated as annual value, the curve was fitted to spread losses over 8.760 hours. Figure 29 shows the calculated relative heat loss curve.

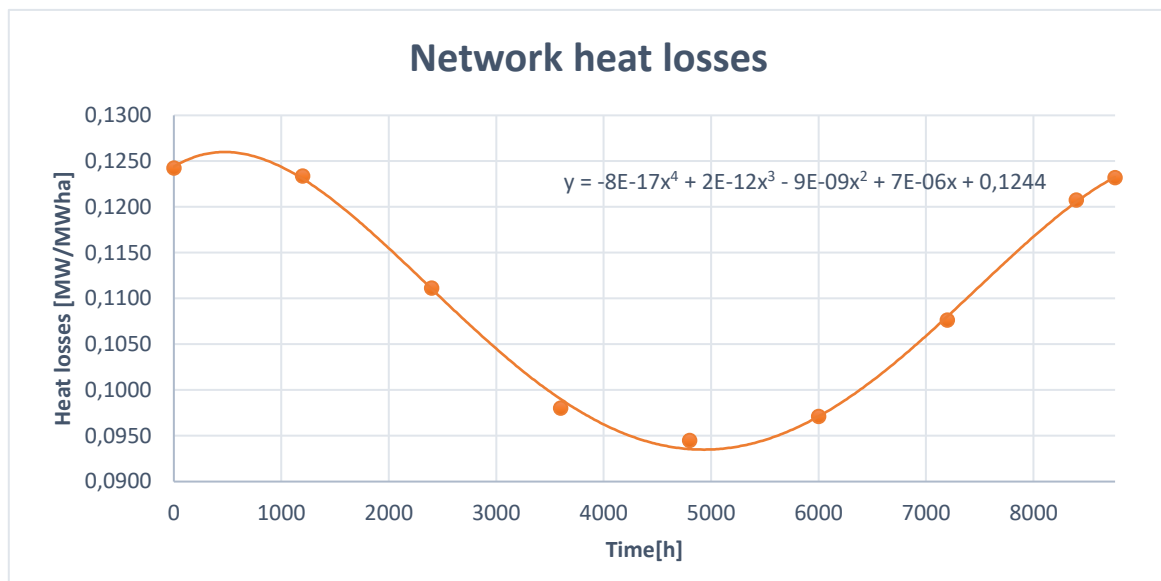

Figure 29 Heat loss curve [27]

To determine annual heat losses, and later, hourly coefficients of performances (COPs) of heat pumps, yearly network supply and return temperatures must be known. Network temperatures were varied, as shown in the operation of other low-temperature district heating systems. It is observed that after the outdoor temperature drops below 10°C, supply temperature starts to rise linearly. However, return temperature does not have the same pattern. At 10°C, the return temperature drops and then incrementally rises linearly as the outdoor temperature continues to fall. Temperature curves and their equations were calculated for supply and return line in ULTDH and LTDH networks, as seen in the given data [28]. Figure 30 shows ULTDH temperature variations as a function of outdoor temperatures, while Figure 31 presents LTDH network temperature variations.

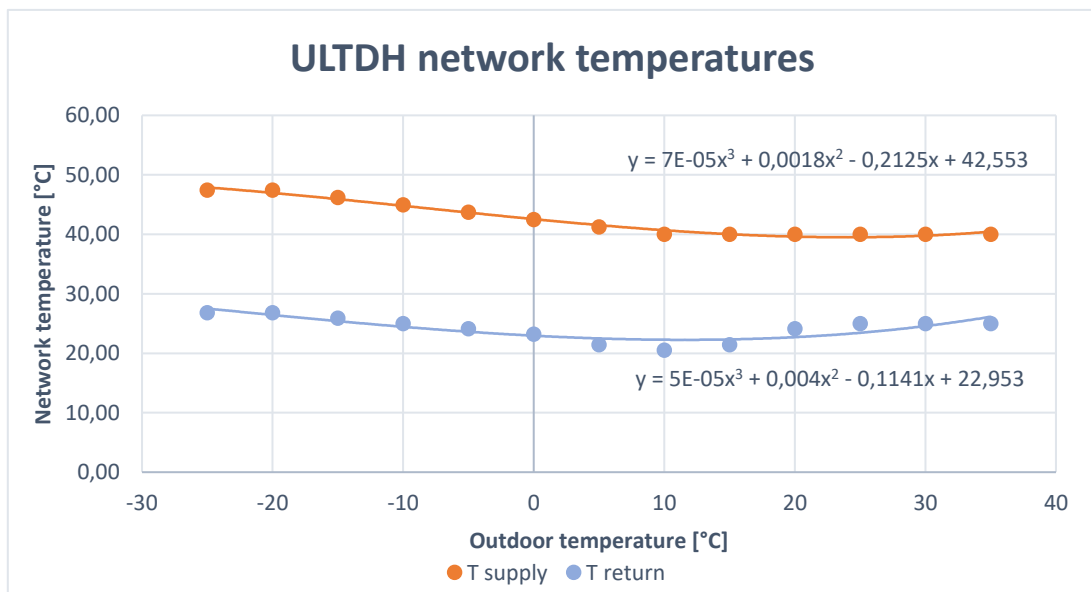

Figure 30 ULTDH temperature variations [28]

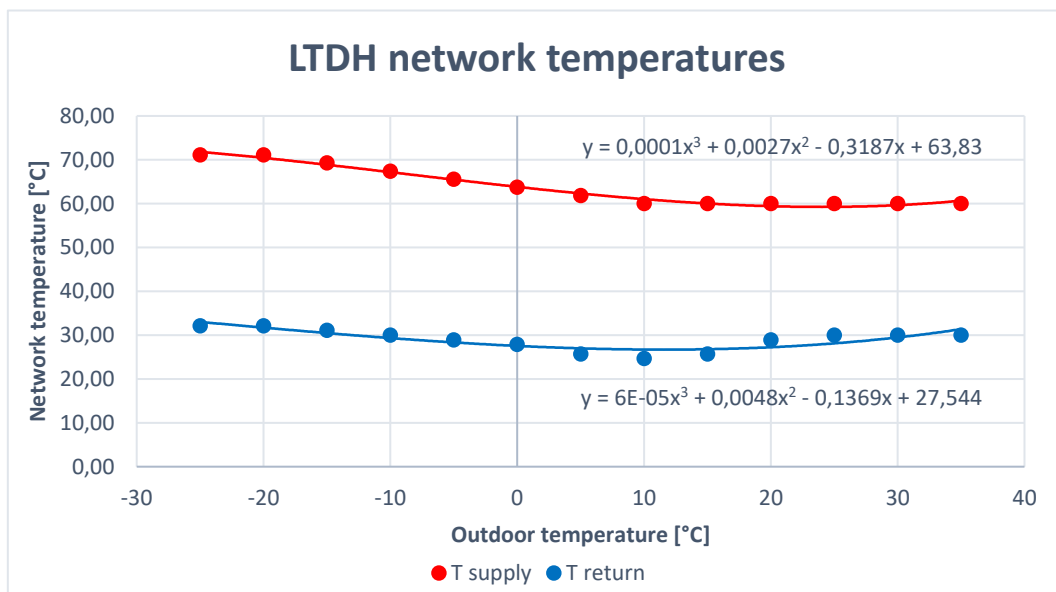

Figure 31 LTDH temperature variations [28]

Calculated hourly network supply and return temperatures in the ULTDH network are shown in Figure 32. Due to lower heat demand in the summer months, return temperature increases, increasing heat losses in the network.

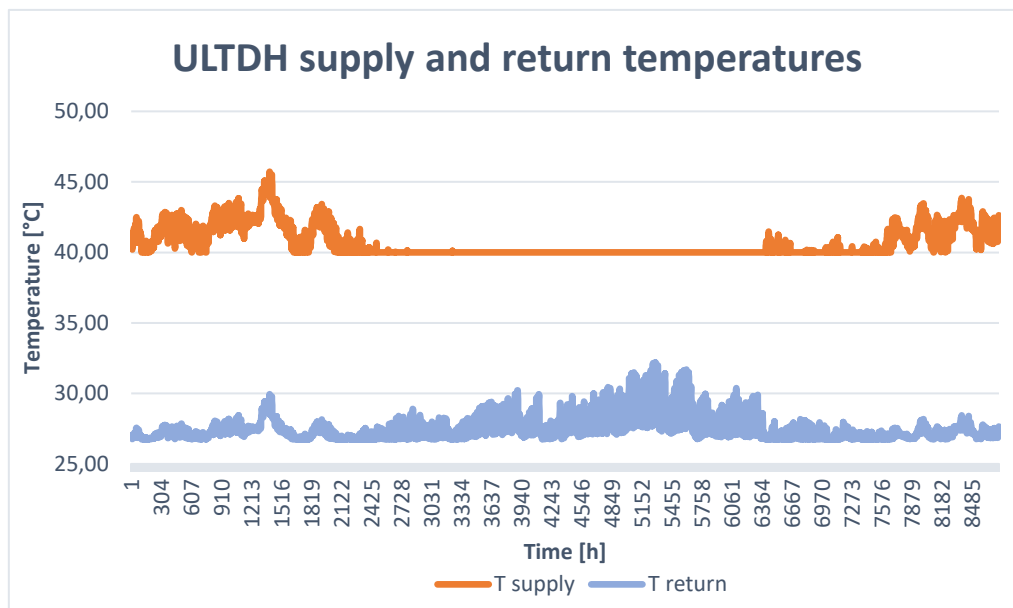

Figure 32 ULTDH network temperatures through the year

LTDH network supply and return temperatures annual variations are shown in Figure 33. As in the ULTDH network, return temperature in summer months slightly increases, increasing heat losses in the network.

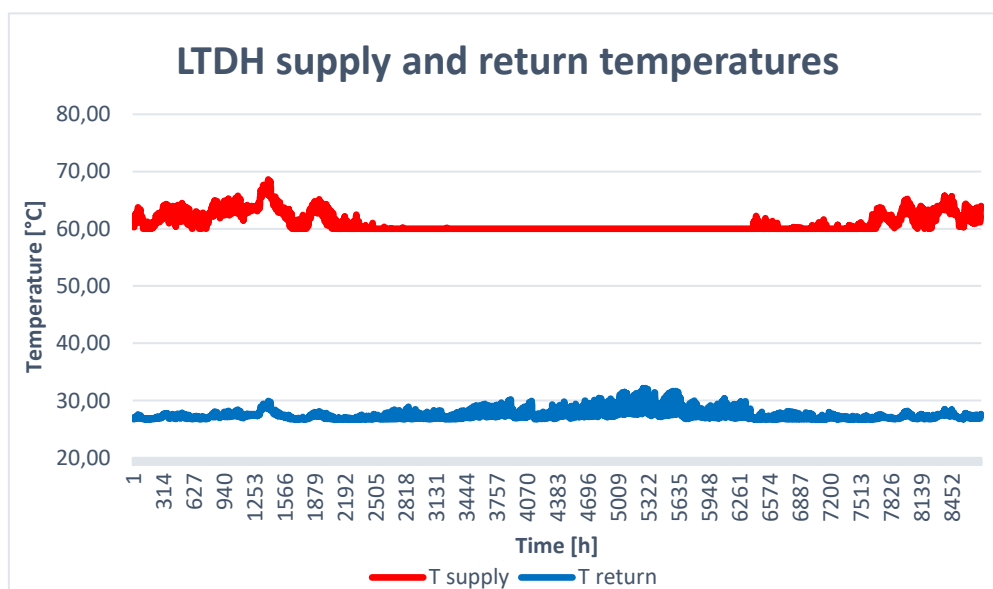

Figure 33 LTDH network temperatures through the year

4.2. System components sizing and costs

All central units were sized to cover 80% of the maximal heat demand of a network in a specific hour. They are coupled with a backup electric boiler designed to cover 25% of the maximal heat demand of a network in a specific hour, as suggested in [15]. Total decentral units capacity was calculated as a ratio between total annual domestic hot water demand $Q_{tot,DHW}$ and full load hours $t_{fullload}$ with equation (30):

$$\dot{Q}_{decentral} = \frac{Q_{tot,DHW}}{t_{fullload}} \quad (30)$$

For decentral heat pumps, full load hours $t_{fullload}$ were 2.000 h/year as suggested in [29] [30], while gas boiler full load hours, in the scenario with individual natural gas heating, were 3.000 h/year as suggested in [31], [32]. In scenarios with individual heating, total heat demand was divided with full load hours instead of just total DHW demand as in other cases. To calculate the number of decentral units, the fixed capacity of one unit was determined. Values for decentral heat pumps were varied between 1,6 kW and 8 kW [15]. 1,6 kW were micro heat pumps while 8 kW heat pumps were booster and air source decentral heat pumps. Investment cost in central, decentral, and individual units and their expected lifetime are listed in Table 5.

Table 5 DH components investment cost [15]

| Technology | Investment cost [MW/€] | Lifetime [year] | Source |
|-----------------|--|-----------------|--------|
| Central ASHP | $0,937 \cdot \dot{Q}_{central}^{-0,1418}$ | 25 | [33] |
| Central GWHP | $1,112 \cdot \dot{Q}_{central}^{-0,23105}$ | 25 | [33] |
| Central EHHP | $0,867 \cdot \dot{Q}_{central}^{-0,1234}$ | 25 | [15] |
| Central EHHEX | $0,26 \cdot \dot{Q}_{central}^{-0,1234}$ | 20 | [33] |
| Electric boiler | 0,11 | 20 | [34] |
| Gas boiler | 0,06 | 25 | [34] |
| Individual ASHP | 0,95 | 15 | [35] |
| Decentral HP | $2,748 \cdot \dot{Q}_{decentral}^{-0,594}$ | 15 | [15] |
| DH substation | $0,414 \cdot \dot{Q}_{decentral}^{-0,536}$ | 25 | [35] |

Variable and fixed annual operation and maintenance costs (O&M) for each component are given in Table 6. Some data could not be found, so fixed operation and maintenance costs were assumed to be the specific component's total operation and maintenance cost.

Table 6 Components O&M costs

| Technology | Fixed O&M [€/MW] | Variable O&M [€/MWh] | Source |
|-----------------|--|----------------------|--------|
| Central ASHP | 2.030 | 1,83 | [36] |
| Central GWHP | 2.030 | 1,83 | [36] |
| Central EHHP | 2.030 | 1,83 | [36] |
| Central EHHEX | 4% of total investment | | [37] |
| Electric boiler | 1.117 | 0,54 | [36] |
| Gas boiler | 14.445 | 0,0107 | [36] |
| Individual ASHP | 20.909 | 0 | [36] |
| Decentral HP | $229,6 + 3 \cdot 852,6 \cdot \dot{Q}_{decentral} [MW]$ | | [15] |
| DH substation | $0,0251 \cdot \ln(\dot{Q}_{decentral}) - 0,0154 [kW]$ | | [35] |

The district heating network was sized according to the given data [36]. The network costs were determined as a function of network length and pipe diameters. Piping cost as a function of pipe diameter is shown in Figure 34. Network lifetime was assumed to be 30 years [38]. The network's annual operation and maintenance costs were assumed to be 0,6% of the initial investment cost in the network [39].

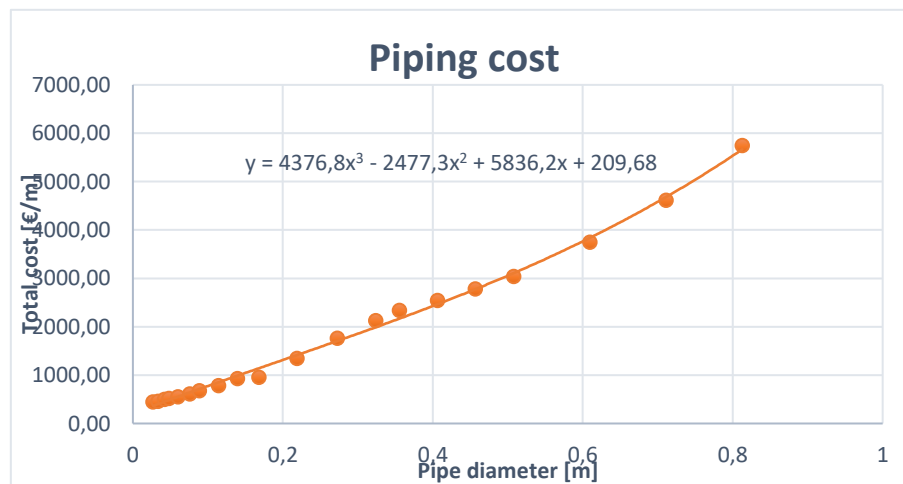

Figure 34 Pipe total cost as a diameter function [36]

The price of electricity was taken from Eurostat as the average electricity price (without taxes) for households and non-household consumers in Europe. Prices were 81,10 €/MWh for non-households and 126,90 €/MWh for households [40]. Gas prices were considered as average European prices for households, 47,60 €/MWh [41].

When it comes to primary energy calculation, primary factor, f_{prim} for electricity was 1,614, and for natural gas 1,095 [42]. Carbon emission factors f_{CO_2} were taken from Croatian data (0,22 tCO₂/MWh for natural gas and 0,12 tCO₂/MWh for electricity [42]).

5. RESULTS AND DISCUSSION

As highlighted in previous chapters, this thesis aimed to determine the Levelized cost of heat LCOH, primary energy factor $f_{prim,scenario}$ and CO_2 factor $f_{CO_2,scenario}$ for different network temperatures, central heat sources, decentral heat sources, and various configurations. Those values were compared to the values from individual gas boiler heating. Figure 35 shows COP values of heat pumps for various central heat sources in LTDH networks, while Figure 36 shows COP values of HPs in the ULTDH network. “Shaved” COP values in Figure 36 are caused by the limitation of temperature lift to 5K to avoid problems when the outdoor temperature is higher than the temperature in the network.

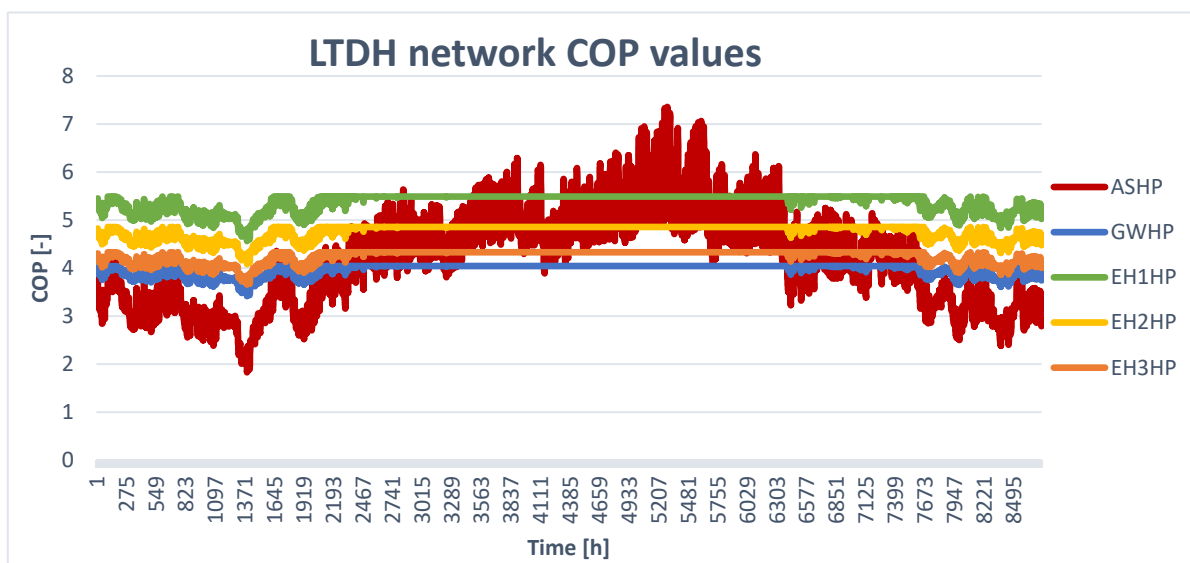

Figure 35 LTDH network COP values

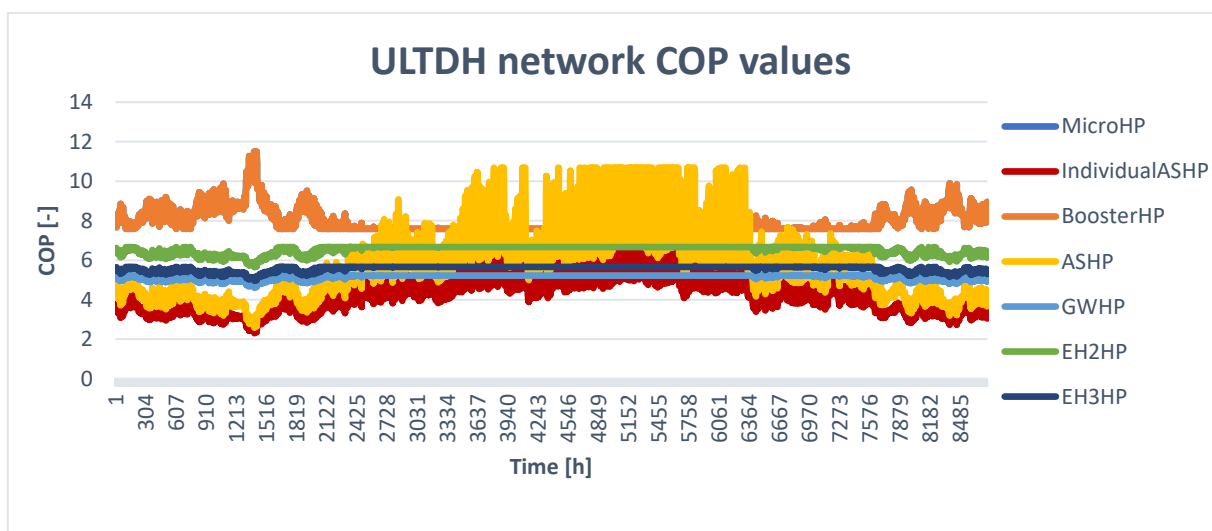

Figure 36 ULTDH network COP values

5.1. Levelized cost of heat (LCOH)

The following charts compare LCOH values for different values of plot ratio and SH share. LCOH for the space heating share of 0,1 (efficient buildings) and plot ratio 0,2 (rural area) is shown in Figure 37. The red line represents the LCOH value of individual gas boiler heating of 75,06 €/MWh. The values above the line represent infeasible solutions compared to individual gas heating. In a district with mentioned characteristics, all values are above the red line, indicating infeasibility compared to individual gas boiler heating.

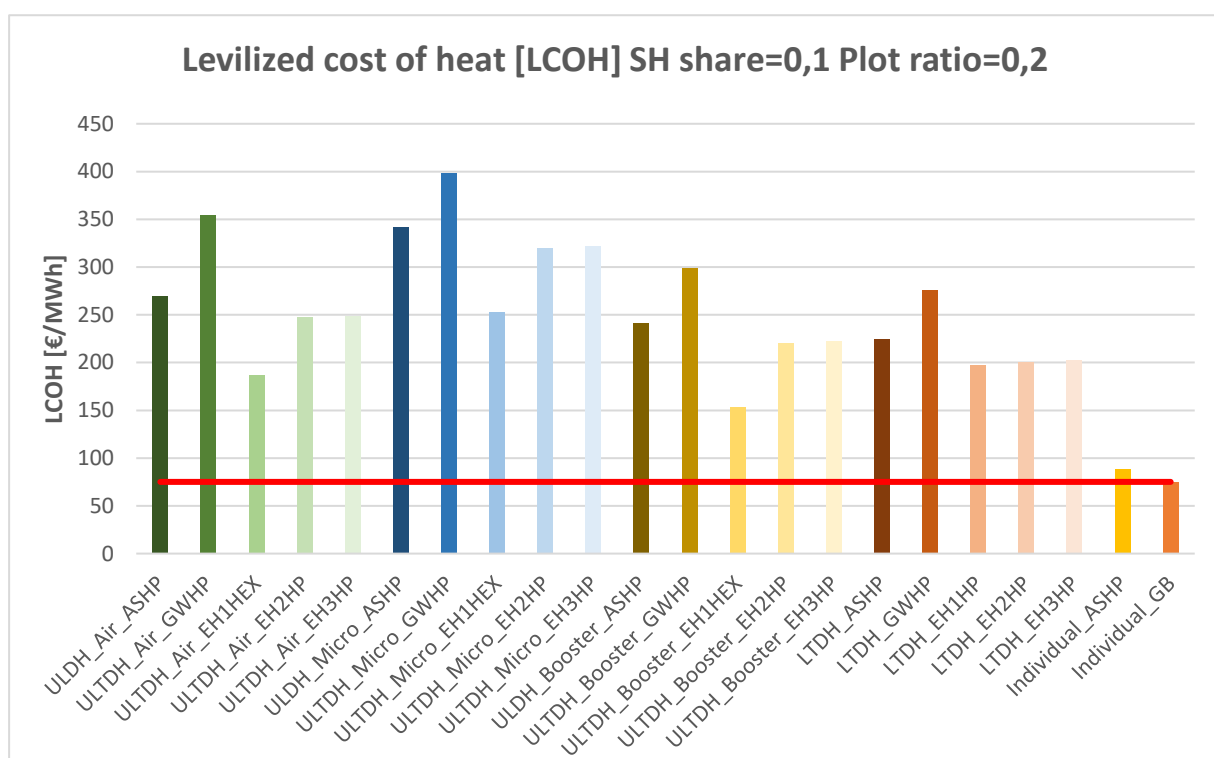

Figure 37 LCOH values for SH share=0,1 and plot ratio=0,2

The highest LCOH can be observed in the ULTDH_Micro_GWHP case due to the high investment cost in the central heat pump and decentral heat pumps. In each subgroup, scenarios with central GWHP have the highest LCOH values due to the high investment cost in a central unit. The subgroup with the highest overall LCOH values is the ULTDH network with micro heat pumps for DHW preparation at each apartment. The reason for that is the high investment cost in decentral and central units and low heat demand. LTDH subgroup has lower LCOH

values than ULTDH subgroups because there is no need for decentral units. Higher losses in the LTDH network due to higher network temperatures and slightly higher investment costs still make these networks profitable compared to ULTDH networks in areas with these characteristics. Figure 38 shows a detailed overview of LCOH values for each scenario. The most considerable portion of LCOH is investment cost in a central unit.

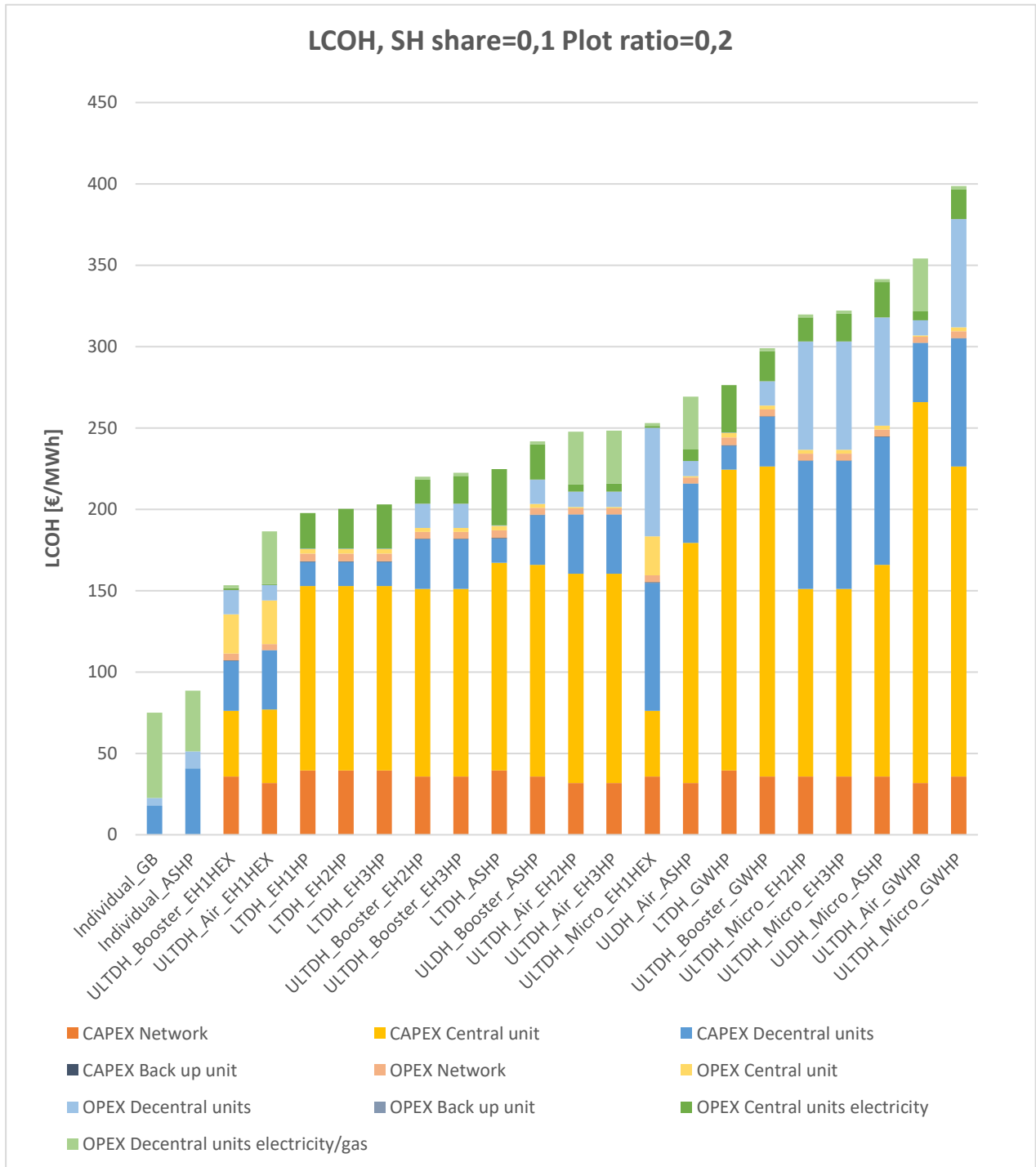

Figure 38 Detailed overview of LCOH, SH share=0,1, plot ratio=0,2

LCOH values for a space heating share of 0,5 and a plot ratio of 1,2, representing characteristics of an average district, are shown in Figure 39.

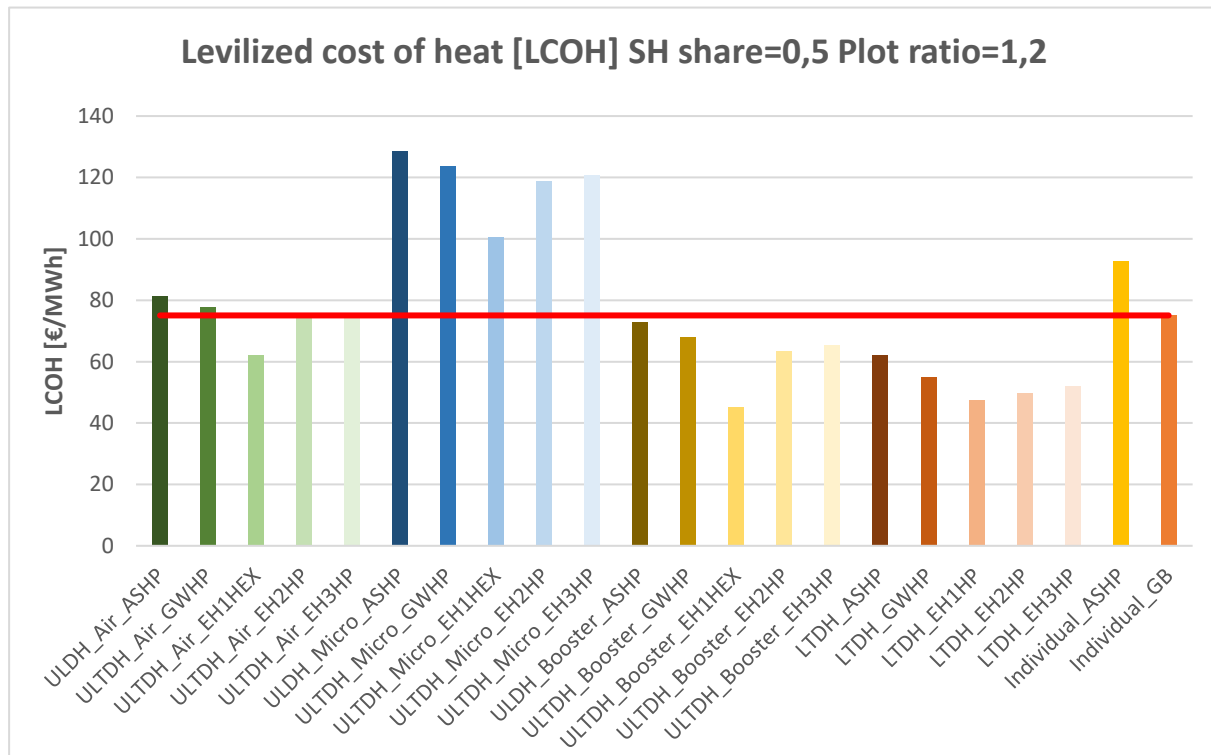

Figure 39 LCOH values for SH share=0,5 and plot ratio=1,2

As in previous observation, values above the red line represent infeasible cases compared to individual natural gas boiler heating. Here all ULTDH cases with micro booster heat pumps, ULTDH cases with air source heat pumps for DHW preparation (central GWHP, ASHP and central HEX for lowest temperature excess heat) and individual heating with ASHP are infeasible compared to individual gas boiler heating. The rest of the cases have lower LCOH values than individual gas boiler heating. Figure 40 shows a detailed overview of LCOH values for this district characteristics. Contrary to the previous district, the most significant portion of LCOH is an investment in decentral heat pump and electricity. The cause for that is higher heat demand (half of it is DHW demand). Overall, LCOH values are lower compared to the previous district. Only individual heating with ASHPs has an increase of LCOH value, while individual gas boiler heat has the same value of LCOH for any plot ratio and SH share combination.

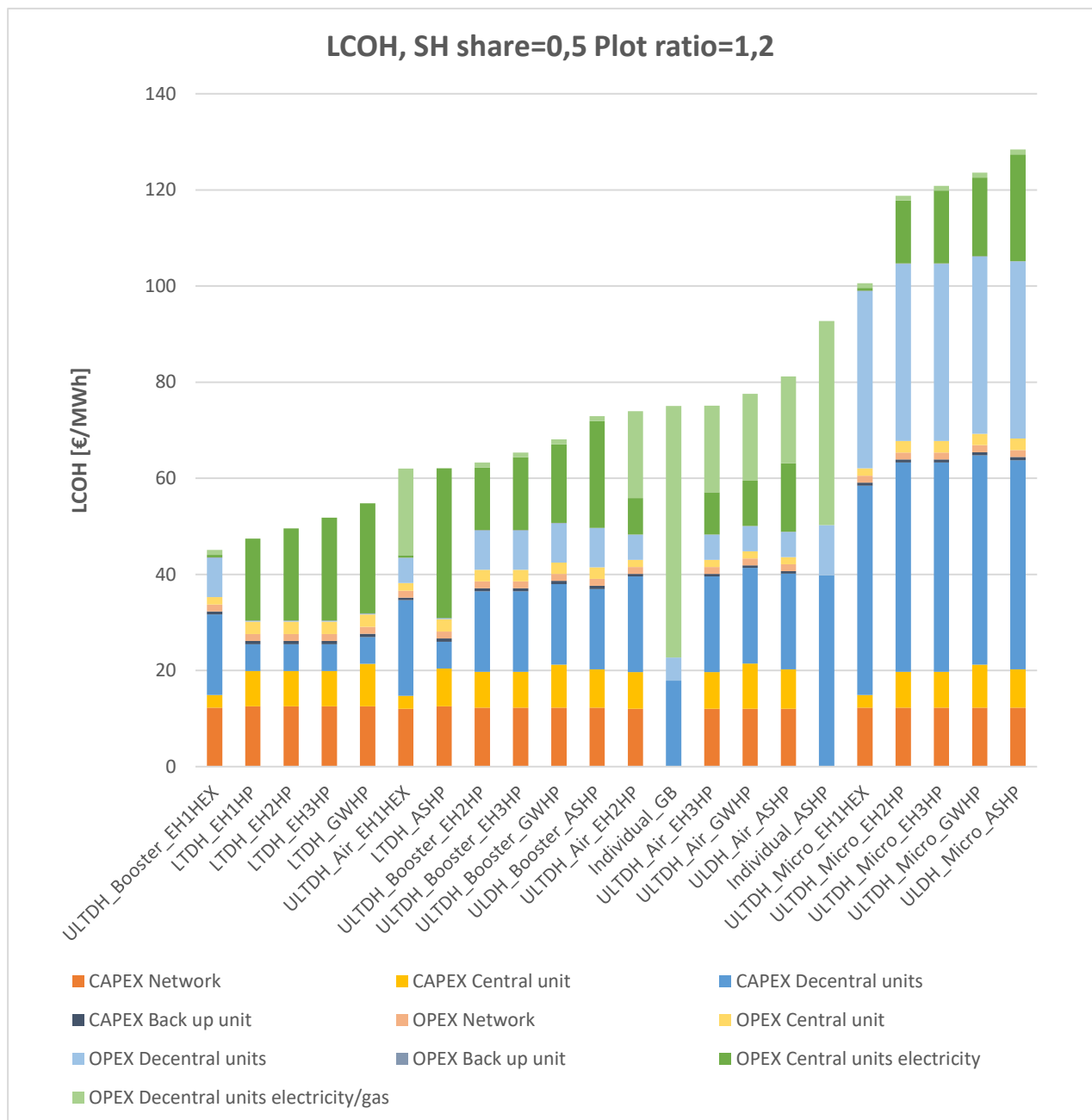

Figure 40 Detailed overview of LCOH, SH share=0,5, plot ratio=1,2

LCOH for space heating share of 0,8 and plot ratio 2 (urban area) is shown in Figure 41. All low and ultra-low temperature networks are below the LCOH value of individual gas boiler heating. That is because high heat demand compensates for investment cost in ULTDH and LTDH in districts such as this. Also, there is a lower need for DHW, which significantly reduces the overall investment cost of a network.

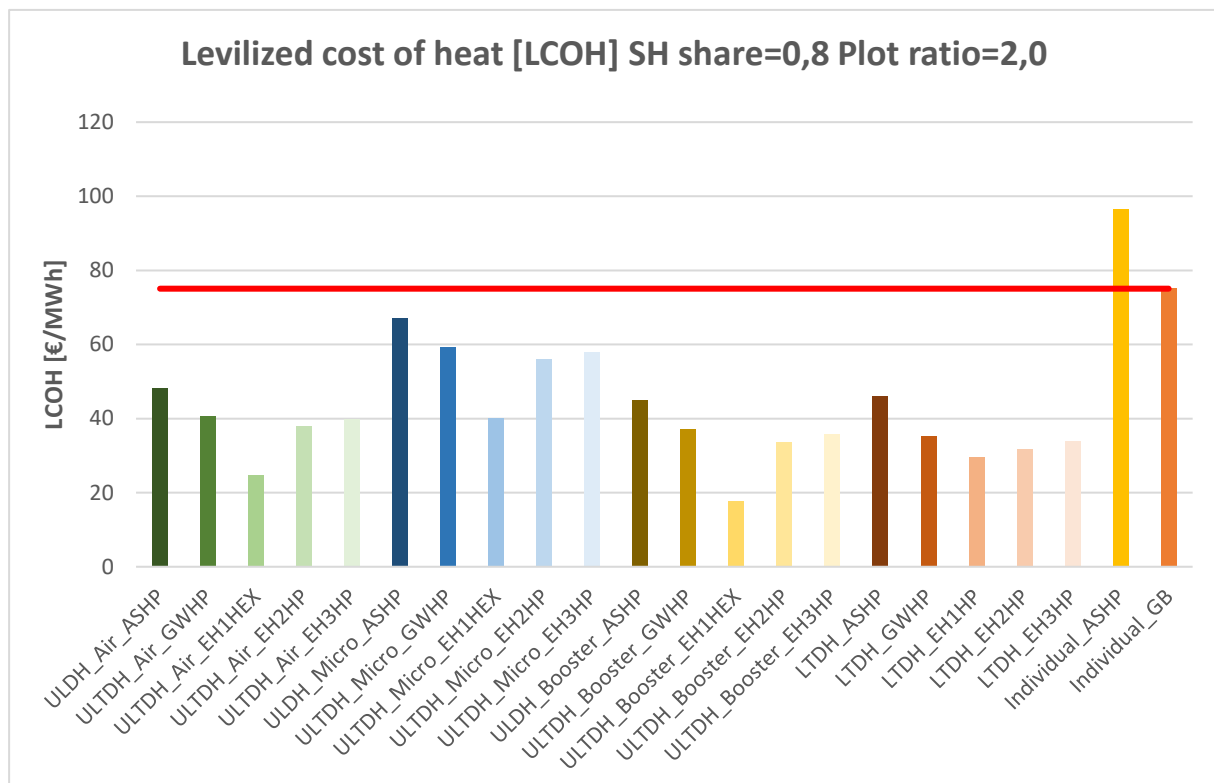

Figure 41 LCOH values for SH share=0,8 and plot ratio=2,0

Detail overview of LCOH values for a district with an SH share of 0,8 and a plot ratio of 2 is shown in Figure 42. Networks with the lowest LCOH values need only a central heat exchanger to supply the network with heat. The exception is a network with a central heat exchanger and micro heat pumps for DHW preparation. Due to the higher investment cost of decentral units, this solution is not the most feasible, but it still has a lower LCOH value than individual gas boiler heating. In this network type (SH share of 0,8 and plot ratio of 2), the most significant portion of the LCOH value is the electricity price of a central unit because the central unit supplies space heating to the networks.

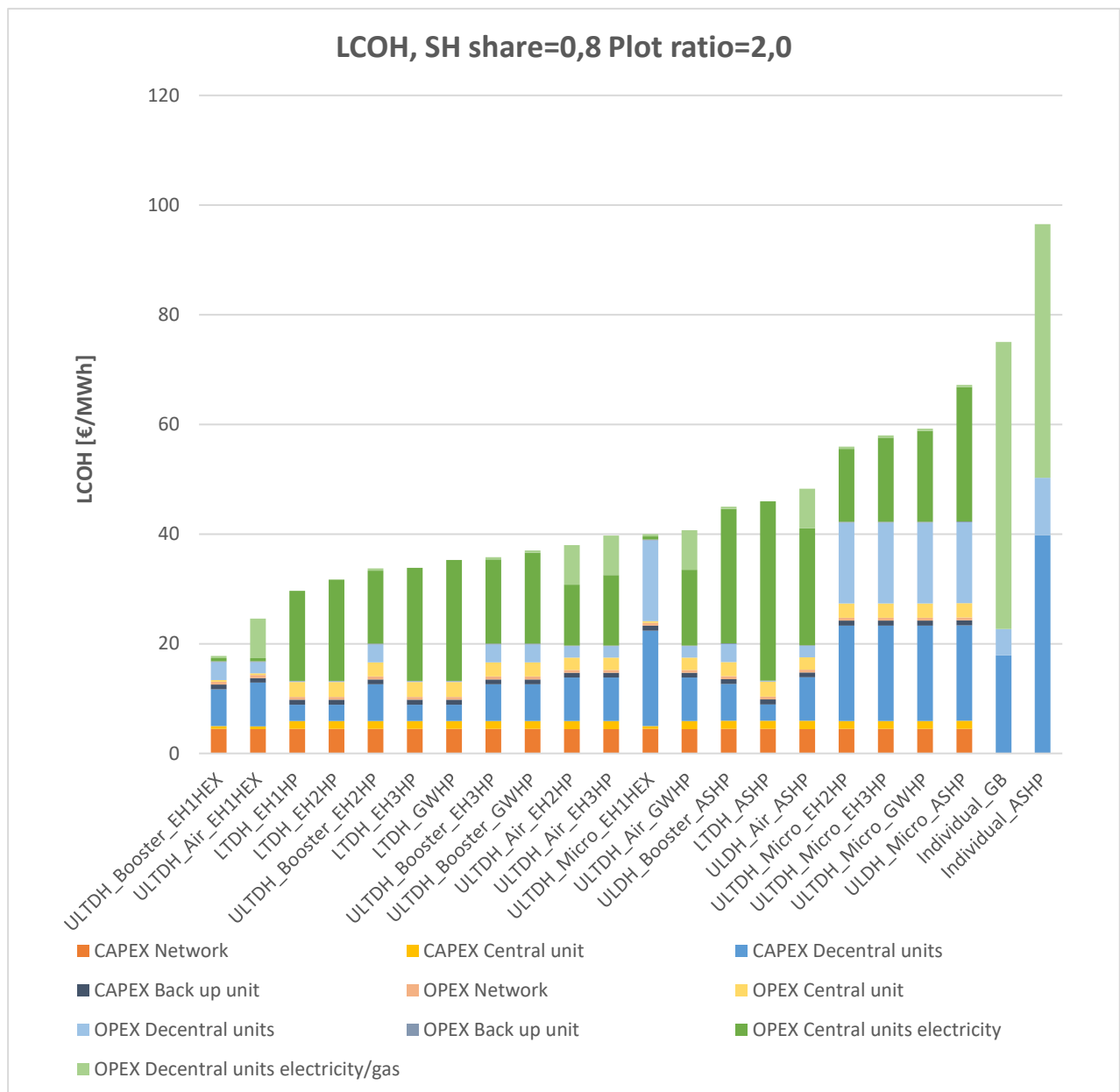

Figure 42 Detailed overview of LCOH, SH share=0,8, plot ratio=2,0

All data tables with LCOH results can be found in the LCOH tables in the Annex of this document. In the following section, one type of central heat source will be analysed, and one district heating configuration, e.g., ULTDH network with micro heat pumps in each apartment for DHW preparation. The highest LCOH value cells are coloured red in all the tables, and the lowest value cells are coloured dark green. Cells with values of LCOH below the LCOH value of individual gas boiler heating (75,1 €/MWh) have borders, and their values are bolded.

Table 7 below shows the ULTDH network, with central ASHP, with micro heat pumps in each apartment unit.

Table 7 LCOH-LTDH_Micro_ASHP

| | | LCOH-ULTDH_Micro_ASHP [€/MWh _h] | | | | | | | |
|----------------|-----|---|-------|-------|-------|-------|-------|-------|-------|
| Plot ratio [-] | | 0,1 | 0,2 | 0,3 | 0,4 | 0,5 | 0,6 | 0,7 | 0,8 |
| | | 2,0 | 192,1 | 174,2 | 156,4 | 138,7 | 120,9 | 103,1 | 85,2 |
| | 1,8 | 194,4 | 176,2 | 158,2 | 140,2 | 122,2 | 104,2 | 86,1 | 67,8 |
| | 1,6 | 197,1 | 178,6 | 160,3 | 142,1 | 123,8 | 105,5 | 87,1 | 68,5 |
| | 1,4 | 200,6 | 181,7 | 163,1 | 144,5 | 125,8 | 107,1 | 88,4 | 69,4 |
| | 1,2 | 205,1 | 185,7 | 166,6 | 147,5 | 128,4 | 109,2 | 90,0 | 70,5 |
| | 1,0 | 211,3 | 191,2 | 171,4 | 151,7 | 132,0 | 112,2 | 92,3 | 72,1 |
| | 0,8 | 220,2 | 199,1 | 178,3 | 157,7 | 137,0 | 116,3 | 95,5 | 74,4 |
| | 0,6 | 234,7 | 212,0 | 189,7 | 167,5 | 145,3 | 123,1 | 100,7 | 78,0 |
| | 0,4 | 262,3 | 236,3 | 210,9 | 185,8 | 160,8 | 135,7 | 110,4 | 84,8 |
| | 0,2 | 341,5 | 306,0 | 271,7 | 238,0 | 204,6 | 171,2 | 137,7 | 103,6 |
| | | 0,1 | 0,2 | 0,3 | 0,4 | 0,5 | 0,6 | 0,7 | 0,8 |
| | | Space heating share [-] | | | | | | | |

High investment cost in micro heat pumps makes this district heating solution infeasible compared to individual natural gas heating for most plot ratio and space heating share combinations. Only scenarios with a high space heating share of 0,8 and plot ratios of 0,8 and above show feasibility compared to gas heating. The reason for that is increased overall heat demand and lower investment in decentral units because DHW need is low compared to SH need.

Table 8 below shows the ULTDH network, with central GWHP, with micro heat pumps in each apartment unit. Compared to the previous case with central ASHP, the case with central GWHP has higher LCOH for lower space heating shares and lower plot ratios (due to higher central heat pump investment). However, as SH share increase, LCOH values start to drop faster than those for central ASHP, and for SH ratios above 0,6, the GWHP scenario is more profitable and ends with more feasible cases than ASHP. The reason for this can be the low efficiency of ASHP due to frosting and other weather conditions, which increases needed electricity consumption.

Table 8 LCOH-ULTDH_Micro_GWHP

| | | LCOH-ULTDH_Micro_GWHP [€/MWh _h] | | | | | | | |
|----------------|-----|---|-------|-------|-------|-------|-------|-------|-------------|
| Plot ratio [-] | 2,0 | 191,2 | 171,9 | 153,0 | 134,2 | 115,5 | 96,8 | 78,0 | 59,2 |
| | 1,8 | 193,8 | 174,2 | 155,0 | 135,9 | 116,9 | 97,9 | 78,9 | 59,8 |
| | 1,6 | 197,0 | 176,9 | 157,3 | 137,9 | 118,6 | 99,2 | 79,9 | 60,5 |
| | 1,4 | 201,2 | 180,6 | 160,5 | 140,6 | 120,8 | 101,0 | 81,3 | 61,4 |
| | 1,2 | 206,5 | 185,2 | 164,5 | 143,9 | 123,6 | 103,3 | 83,0 | 62,6 |
| | 1,0 | 214,2 | 191,8 | 170,1 | 148,7 | 127,5 | 106,5 | 85,4 | 64,2 |
| | 0,8 | 225,4 | 201,5 | 178,4 | 155,7 | 133,3 | 111,0 | 88,8 | 66,6 |
| | 0,6 | 244,3 | 217,7 | 192,2 | 167,3 | 142,9 | 118,6 | 94,5 | 70,4 |
| | 0,4 | 281,8 | 249,8 | 219,5 | 190,1 | 161,5 | 133,4 | 105,5 | 77,8 |
| | 0,2 | 398,7 | 349,1 | 303,2 | 259,7 | 218,0 | 177,5 | 138,1 | 99,3 |
| | | 0,1 | 0,2 | 0,3 | 0,4 | 0,5 | 0,6 | 0,7 | 0,8 |
| | | Space heating share [-] | | | | | | | |

Table 9 shows the ULTDH network, with central HEX with excess heat at temperatures high enough to not need the heat pump in a central location. Micro heat pumps are in each apartment unit. This is an ideal scenario because it is hard to find an excess heat source with high enough temperatures throughout the year (temperatures above 40°C). Compared to previous cases, this case has lower LCOH values throughout the entire table. However, lower electricity consumption cannot make up for the high investment costs in micro heat pumps, and thus LCOH values for low space heating shares and low plot ratios are still higher than those for individual gas boiler heating. This case is profitable for every plot ratio value with a space heating share of 0,8, and most of the plot ratios with a space heating share of 0,7. In these cases, investment in decentral heat pumps for DHW preparation is lower.

Table 9 LCOH-ULTDH_Micro_EH1HEX

| | | LCOH-ULTDH_Micro_EH1HEX [€/MWh _h] | | | | | | | |
|----------------|-----|---|-------|-------|-------|-------|-------|-------------|-------------|
| Plot ratio [-] | 2,0 | 167,7 | 149,4 | 131,3 | 113,2 | 95,1 | 76,8 | 58,5 | 40,0 |
| | 1,8 | 169,4 | 150,9 | 132,7 | 114,4 | 96,1 | 77,7 | 59,1 | 40,4 |
| | 1,6 | 171,2 | 152,6 | 134,2 | 115,7 | 97,2 | 78,6 | 59,9 | 41,0 |
| | 1,4 | 173,6 | 154,8 | 136,1 | 117,5 | 98,7 | 79,9 | 60,9 | 41,7 |
| | 1,2 | 176,6 | 157,4 | 138,5 | 119,6 | 100,6 | 81,5 | 62,1 | 42,6 |
| | 1,0 | 180,7 | 161,2 | 141,9 | 122,6 | 103,2 | 83,6 | 63,9 | 43,8 |
| | 0,8 | 186,3 | 166,3 | 146,5 | 126,6 | 106,7 | 86,6 | 66,2 | 45,5 |
| | 0,6 | 195,3 | 174,4 | 153,8 | 133,1 | 112,3 | 91,3 | 70,0 | 48,2 |
| | 0,4 | 211,2 | 188,8 | 166,7 | 144,6 | 122,3 | 99,7 | 76,7 | 53,1 |
| | 0,2 | 253,0 | 226,6 | 200,7 | 174,8 | 148,5 | 121,8 | 94,3 | 65,9 |
| | | 0,1 | 0,2 | 0,3 | 0,4 | 0,5 | 0,6 | 0,7 | 0,8 |
| | | Space heating share [-] | | | | | | | |

Table 10 and Table 11 show ULTDH networks with central heat pump supplied with excess heat. The temperatures of excess heat in those scenarios are lower than those depicted in Table 9, and thus central heat pump is needed. Investment in the heat pump is higher than investment in a central heat exchanger, which, along with higher electricity consumption, increases LCOH value compared to the previous scenario.

Table 10 LCOH-ULTDH_Micro_EH2HP

| | | LCOH-ULTDH_Micro_EH2HP [€/MWh _h] | | | | | | | |
|----------------|-----|--|-------|-------|-------|-------|-------|-------------|-------------|
| Plot ratio [-] | 2,0 | 185,4 | 166,8 | 148,4 | 130,1 | 111,7 | 93,2 | 74,6 | 55,9 |
| | 1,8 | 187,6 | 168,7 | 150,1 | 131,5 | 112,9 | 94,2 | 75,4 | 56,5 |
| | 1,6 | 190,1 | 171,0 | 152,1 | 133,3 | 114,4 | 95,5 | 76,4 | 57,2 |
| | 1,4 | 193,4 | 173,9 | 154,7 | 135,6 | 116,4 | 97,1 | 77,7 | 58,1 |
| | 1,2 | 197,5 | 177,6 | 158,0 | 138,4 | 118,8 | 99,1 | 79,2 | 59,2 |
| | 1,0 | 203,3 | 182,8 | 162,6 | 142,4 | 122,2 | 101,9 | 81,4 | 60,7 |
| | 0,8 | 211,5 | 190,1 | 169,0 | 148,0 | 127,0 | 105,8 | 84,5 | 62,8 |
| | 0,6 | 224,8 | 202,0 | 179,5 | 157,1 | 134,7 | 112,2 | 89,4 | 66,3 |
| | 0,4 | 249,6 | 224,1 | 199,0 | 174,1 | 149,1 | 124,0 | 98,6 | 72,8 |
| | 0,2 | 319,8 | 286,3 | 253,7 | 221,4 | 189,2 | 156,8 | 124,0 | 90,5 |
| | | 0,1 | 0,2 | 0,3 | 0,4 | 0,5 | 0,6 | 0,7 | 0,8 |
| | | Space heating share [-] | | | | | | | |

Table 11 LCOH-ULTDH_Micro_EH3HP

| | | LCOH-ULTDH_Micro_EH3HP [€/MWh _h] | | | | | | | |
|----------------|-----|--|-------|-------|-------|-------|-------|-------|-------------|
| Plot ratio [-] | 2,0 | 187,4 | 168,8 | 150,4 | 132,1 | 113,7 | 95,2 | 76,7 | 58,0 |
| | 1,8 | 189,6 | 170,7 | 152,2 | 133,6 | 115,0 | 96,3 | 77,5 | 58,6 |
| | 1,6 | 192,1 | 173,0 | 154,2 | 135,3 | 116,5 | 97,5 | 78,5 | 59,3 |
| | 1,4 | 195,4 | 176,0 | 156,8 | 137,6 | 118,4 | 99,1 | 79,7 | 60,1 |
| | 1,2 | 199,5 | 179,7 | 160,1 | 140,5 | 120,9 | 101,1 | 81,3 | 61,2 |
| | 1,0 | 205,3 | 184,9 | 164,7 | 144,5 | 124,3 | 104,0 | 83,5 | 62,8 |
| | 0,8 | 213,5 | 192,2 | 171,1 | 150,1 | 129,1 | 107,9 | 86,6 | 64,9 |
| | 0,6 | 226,9 | 204,1 | 181,6 | 159,3 | 136,8 | 114,3 | 91,5 | 68,4 |
| | 0,4 | 251,8 | 226,2 | 201,2 | 176,2 | 151,3 | 126,1 | 100,7 | 74,9 |
| | 0,2 | 322,1 | 288,6 | 256,0 | 223,7 | 191,4 | 159,0 | 126,2 | 92,7 |
| | | 0,1 | 0,2 | 0,3 | 0,4 | 0,5 | 0,6 | 0,7 | 0,8 |
| | | Space heating share [-] | | | | | | | |

Despite the inferior results than the case with the central heat exchanger, they perform better than central ASHP and GWHP. The cause is higher source temperatures and the lower needed temperature lift at the central heat pump, which slightly decreases electricity consumption. Still, high investment cost and high overall electricity consumption of most combinations of plot ratio and space heating shares result in higher LCOH values than those for individual gas heating.

The following paragraphs will analyse how the same central heat source performs in different network configurations. For that purpose, ASHP central unit has been chosen and evaluated. As shown in Table 7, the ULTDH network with ASHP and micro heat pumps at each consumer apartment showed infeasibility compared to individual natural gas heating due to the higher cost of investment and higher electricity consumption.

Table 12 shows LCOH values of the ULTDH network with central ASHP and ASHPs at consumer substation for DHW preparation. This scenario shows better results than the case depicted in Table 7, and it is more cost-competitive to individual gas heating. This case performs better because of the higher investment cost of micro heat pumps than air-source heat pumps.

Table 12 LCOH-ULTDH_Air_ASHP

| | | LCOH-ULTDH_Air_ASHP [€/MWh _n] | | | | | | | |
|----------------|-----|---|-------|-------|-------|-------------|-------------|-------------|-------------|
| Plot ratio [-] | 2,0 | 107,9 | 98,9 | 90,4 | 82,0 | 73,7 | 65,3 | 56,9 | 48,3 |
| | 1,8 | 110,3 | 101,0 | 92,2 | 83,6 | 75,0 | 66,4 | 57,7 | 48,9 |
| | 1,6 | 113,1 | 103,4 | 94,3 | 85,4 | 76,6 | 67,7 | 58,7 | 49,6 |
| | 1,4 | 116,9 | 106,7 | 97,1 | 87,8 | 78,6 | 69,3 | 60,0 | 50,5 |
| | 1,2 | 121,6 | 110,7 | 100,7 | 90,9 | 81,2 | 71,4 | 61,6 | 51,6 |
| | 1,0 | 128,3 | 116,5 | 105,6 | 95,1 | 84,8 | 74,4 | 63,9 | 53,2 |
| | 0,8 | 137,8 | 124,6 | 112,6 | 101,2 | 89,8 | 78,5 | 67,1 | 55,5 |
| | 0,6 | 153,5 | 138,0 | 124,2 | 111,1 | 98,2 | 85,3 | 72,3 | 59,1 |
| | 0,4 | 183,2 | 163,3 | 146,0 | 129,6 | 113,7 | 97,9 | 82,1 | 65,9 |
| | 0,2 | 269,3 | 236,4 | 208,5 | 182,7 | 158,0 | 133,7 | 109,4 | 84,7 |
| | | 0,1 | 0,2 | 0,3 | 0,4 | 0,5 | 0,6 | 0,7 | 0,8 |
| | | Space heating share [-] | | | | | | | |

Table 13 presents ULTDH with central ASHP, but with booster heat pumps at the building level. This scenario has lower LCOH values due to lower investment cost in decentral units than the previous two scenarios with central ASHPs.

Table 13 LCOH-ULTDH_Booster_ASHP

| | | LCOH-ULTDH_Booster_ASHP [€/MWh _n] | | | | | | | |
|----------------|-----|---|-------|-------|-------------|-------------|-------------|-------------|-------------|
| Plot ratio [-] | 2,0 | 92,2 | 85,4 | 78,7 | 72,1 | 65,4 | 58,7 | 51,9 | 45,0 |
| | 1,8 | 94,5 | 87,4 | 80,5 | 73,7 | 66,8 | 59,8 | 52,8 | 45,6 |
| | 1,6 | 97,2 | 89,8 | 82,6 | 75,5 | 68,3 | 61,1 | 53,8 | 46,3 |
| | 1,4 | 100,8 | 93,0 | 85,4 | 77,9 | 70,4 | 62,8 | 55,1 | 47,2 |
| | 1,2 | 105,2 | 96,9 | 88,9 | 80,9 | 72,9 | 64,9 | 56,7 | 48,3 |
| | 1,0 | 111,5 | 102,5 | 93,8 | 85,1 | 76,5 | 67,8 | 59,0 | 49,9 |
| | 0,8 | 120,3 | 110,3 | 100,6 | 91,1 | 81,5 | 71,9 | 62,2 | 52,2 |
| | 0,6 | 134,9 | 123,3 | 112,0 | 100,9 | 89,9 | 78,7 | 67,4 | 55,8 |
| | 0,4 | 162,4 | 147,5 | 133,2 | 119,2 | 105,3 | 91,3 | 77,1 | 62,6 |
| | 0,2 | 241,8 | 217,4 | 194,2 | 171,6 | 149,2 | 126,9 | 104,4 | 81,5 |
| | | 0,1 | 0,2 | 0,3 | 0,4 | 0,5 | 0,6 | 0,7 | 0,8 |
| | | Space heating share [-] | | | | | | | |

In a group where central ASHP supplies the network, the LTDH network has the lowest LCOH values for any space heating share and plot ratio combination, as shown in Table 14. Lower LCOH values mean that investment cost is lower, as well as electricity consumption.

Table 14 LCOH-LTDH_ASHP

| | | LCOH-LTDH_ASHP [€/MWh _h] | | | | | | | |
|----------------|-----|--------------------------------------|-------|-------|-------|-------|-------|-------|------|
| Plot ratio [-] | 2,0 | 60,2 | 58,3 | 56,5 | 54,8 | 52,9 | 50,8 | 48,5 | 46,0 |
| | 1,8 | 62,8 | 60,6 | 58,6 | 56,6 | 54,5 | 52,2 | 49,6 | 46,8 |
| | 1,6 | 66,0 | 63,5 | 61,2 | 58,9 | 56,4 | 53,8 | 50,9 | 47,7 |
| | 1,4 | 70,0 | 67,1 | 64,5 | 61,7 | 58,9 | 55,9 | 52,6 | 48,9 |
| | 1,2 | 75,2 | 71,8 | 68,6 | 65,4 | 62,1 | 58,5 | 54,7 | 50,4 |
| | 1,0 | 82,2 | 78,1 | 74,3 | 70,4 | 66,3 | 62,1 | 57,5 | 52,5 |
| | 0,8 | 92,4 | 87,2 | 82,4 | 77,5 | 72,5 | 67,2 | 61,6 | 55,4 |
| | 0,6 | 108,6 | 101,8 | 95,3 | 88,8 | 82,1 | 75,2 | 67,9 | 60,0 |
| | 0,4 | 139,3 | 129,2 | 119,6 | 110,0 | 100,3 | 90,2 | 79,7 | 68,4 |
| | 0,2 | 224,8 | 205,3 | 186,7 | 168,2 | 149,7 | 130,9 | 111,5 | 91,0 |
| | | 0,1 | 0,2 | 0,3 | 0,4 | 0,5 | 0,6 | 0,7 | 0,8 |
| | | Space heating share [-] | | | | | | | |

Table 15 shows the lowest LCOH value for every plot ratio and space heating share. Red values represent cases where only individual gas boiler heating is feasible, and the rest of the values corresponds to different low or ultra-low temperature district heating systems.

Table 15 The Lowest LCOH

| | | The Lowest LCOH [€/MWh _h] | | | | | | | |
|----------------|-----|---------------------------------------|------|------|------|------|------|------|------|
| Plot ratio [-] | 2,0 | 48,9 | 46,2 | 43,8 | 41,3 | 38,7 | 32,4 | 25,2 | 17,8 |
| | 1,8 | 51,4 | 48,4 | 45,8 | 43,1 | 40,2 | 33,3 | 25,9 | 18,3 |
| | 1,6 | 54,4 | 51,1 | 48,2 | 45,2 | 41,7 | 34,2 | 26,6 | 18,8 |
| | 1,4 | 58,1 | 54,5 | 51,2 | 47,9 | 43,3 | 35,5 | 27,6 | 19,5 |
| | 1,2 | 62,9 | 58,9 | 55,2 | 51,4 | 45,1 | 37,1 | 28,8 | 20,4 |
| | 1,0 | 69,5 | 64,8 | 60,4 | 56,0 | 47,7 | 39,2 | 30,6 | 21,6 |
| | 0,8 | 75,1 | 73,2 | 68,0 | 60,0 | 51,2 | 42,2 | 32,9 | 23,3 |
| | 0,6 | 75,1 | 75,1 | 75,1 | 66,6 | 56,8 | 46,9 | 36,7 | 26,1 |
| | 0,4 | 75,1 | 75,1 | 75,1 | 75,1 | 66,8 | 55,3 | 43,4 | 30,9 |
| | 0,2 | 75,1 | 75,1 | 75,1 | 75,1 | 75,1 | 75,1 | 61,1 | 43,8 |
| | | 0,1 | 0,2 | 0,3 | 0,4 | 0,5 | 0,6 | 0,7 | 0,8 |
| | | Space heating share [-] | | | | | | | |

Table 16 shows the best system solution based on LCOH for every plot ratio and space heating share combination. Here yellow fields represent that the most feasible district heating solution is the LTDH network with a central heat pump supplied with 40°C excess heat. Green fields mean that the most feasible solution is the ULTDH network supplied through HEX with excess heat of 40°C. This ULTDH solution is the one with booster heat pumps at the building level. Orange fields represent that the lowest LCOH values for given space heating shares and plot ratios are achieved in individual gas boiler heating. LTDH is profitable at lower space heating shares because there is no high investment in decentral heat pumps. However, as the share of space heating increases, the ULTDH booster solution becomes more feasible because the central heat exchanger has a lower investment cost than the central heat pump, and investment in decentral heat pumps is not as high as DHW preparation need drops.

Table 16 The Lowest LCOH-cases

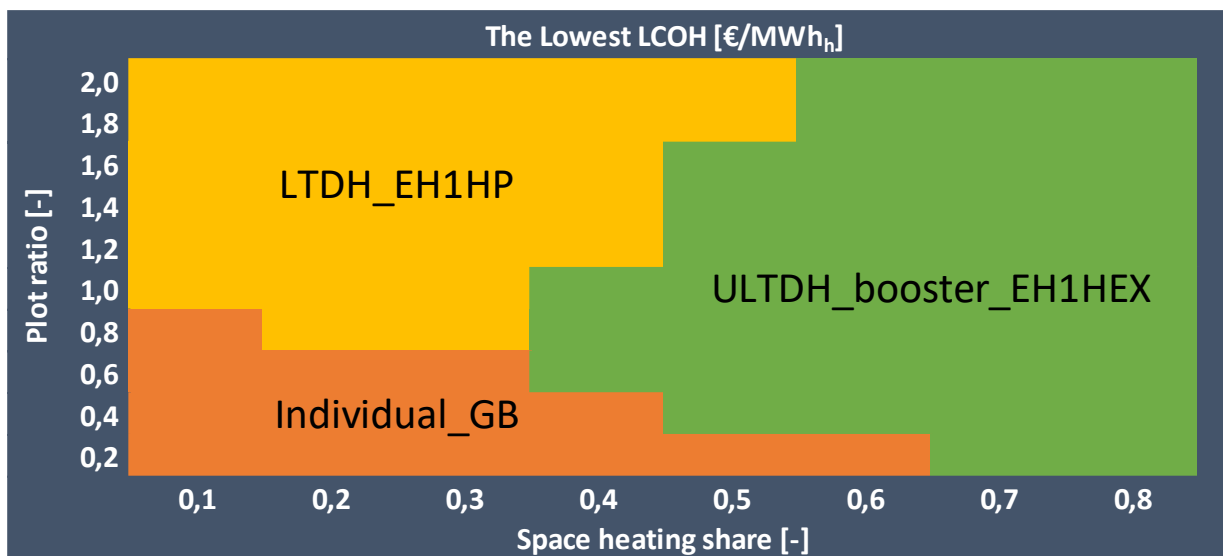

Table 17 depicts the lowest LCOH values of the district heating system if there is no available excess heat. Table 18 shows the most feasible system for every plot ratio-space heating share combination if there is no available excess heat in the network. As in Table 16, individual gas boiler heating is represented with orange fields. Light blue fields present an LTDH system with a central groundwater heat pump. Dark blue fields present ULTDH systems with a booster heat pump at the building level and GWHP as a central unit. LTDH systems with central GWHP are more feasible for lower space heating shares because there is no need for expensive decentral heat pumps. ULTDH systems with booster heat pumps and central GWHP become feasible at

higher space heating shares as DHW need decreases, and thus investment in decentral booster heat pumps drops. The reason because GWHPs are more feasible than ASHPs is their almost constant source temperature throughout the year.

Table 17 The Lowest LCOH without the EH

| | | The Lowest LCOH without the EH [€/MWh _h] | | | | | | | |
|----------------|-----|--|------|------|------|------|------|------|------|
| Plot ratio [-] | 2,0 | 57,3 | 53,9 | 50,9 | 48,0 | 45,0 | 41,9 | 38,7 | 35,3 |
| | 1,8 | 60,2 | 56,5 | 53,2 | 50,0 | 46,7 | 43,3 | 39,8 | 36,1 |
| | 1,6 | 63,9 | 59,7 | 56,0 | 52,4 | 48,8 | 45,1 | 41,2 | 37,0 |
| | 1,4 | 68,5 | 63,8 | 59,6 | 55,5 | 51,4 | 47,2 | 42,9 | 38,2 |
| | 1,2 | 74,5 | 69,1 | 64,2 | 59,5 | 54,8 | 50,0 | 45,0 | 39,8 |
| | 1,0 | 75,1 | 75,1 | 70,6 | 65,0 | 59,4 | 53,8 | 48,0 | 41,9 |
| | 0,8 | 75,1 | 75,1 | 75,1 | 73,0 | 66,2 | 59,3 | 52,2 | 44,4 |
| | 0,6 | 75,1 | 75,1 | 75,1 | 75,1 | 75,1 | 68,1 | 59,0 | 48,3 |
| | 0,4 | 75,1 | 75,1 | 75,1 | 75,1 | 75,1 | 75,1 | 72,0 | 55,6 |
| | 0,2 | 75,1 | 75,1 | 75,1 | 75,1 | 75,1 | 75,1 | 75,1 | 75,1 |
| | | 0,1 | 0,2 | 0,3 | 0,4 | 0,5 | 0,6 | 0,7 | 0,8 |
| | | Space heating share [-] | | | | | | | |

Table 18 The Lowest LCOH without the EH-cases

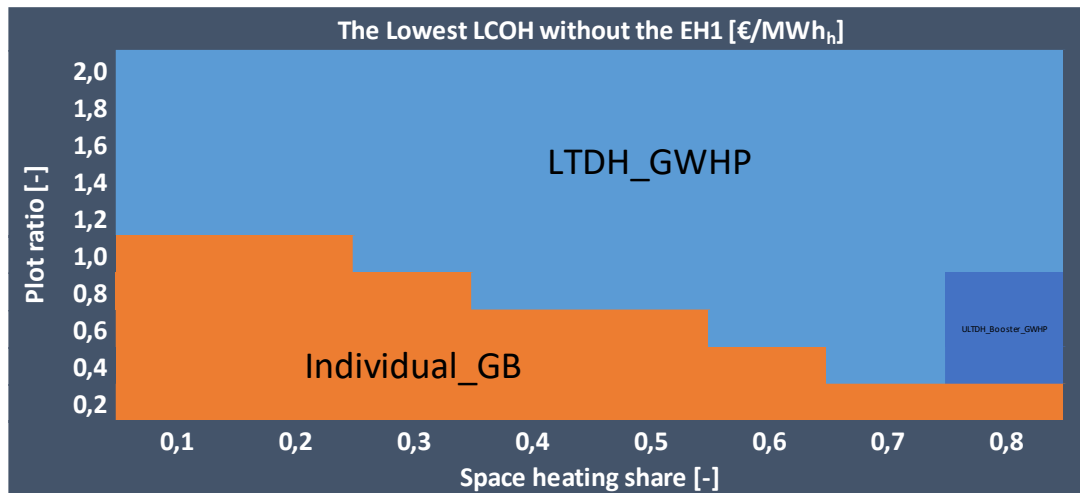

5.2. Primary energy factor

The primary energy factor shows how much primary energy is used to cover consumer heat demand. Scenarios with higher electricity consumption have higher primary energy factors. Results have shown that every low and ultra-low temperature district heating case has a lower primary energy factor than the primary energy factor for individual gas boiler heating, which has a value of 1,205.

Analysis of primary energy factors has been conducted for one district heating configuration (for different central sources) and one central heat source in different network configurations. All primary energy factors datasets are available in Primary energy factor tables in the Annex of this document.

Table 19 shows the primary energy factor of the ULTDH network with central ASHP and micro heat pumps for DHW preparation in each apartment. As space heating share increases, the primary energy factor increases. The reason for this is the higher electricity consumption of the central unit, which is the result of adjustments made to account for problems regarding the frosting of ASHPs. Correction factors influence only central unit electricity consumption, and thus, when more space heating is needed, at higher space heating shares, more electricity (primary energy) is used.

Table 19 Primary energy factor-ULTDH_Micro_ASHP

| | | Primary energy factor-ULTDH_Micro_ASHP [MWh/MWh _n] | | | | | | | |
|----------------|-----|--|-------|-------|-------|-------|-------|-------|-------|
| Plot ratio [-] | 2,0 | 0,394 | 0,406 | 0,420 | 0,435 | 0,450 | 0,464 | 0,479 | 0,493 |
| | 1,8 | 0,396 | 0,407 | 0,421 | 0,436 | 0,451 | 0,465 | 0,480 | 0,494 |
| | 1,6 | 0,397 | 0,408 | 0,422 | 0,437 | 0,452 | 0,466 | 0,480 | 0,494 |
| | 1,4 | 0,399 | 0,410 | 0,424 | 0,438 | 0,453 | 0,467 | 0,481 | 0,495 |
| | 1,2 | 0,402 | 0,412 | 0,426 | 0,440 | 0,454 | 0,468 | 0,482 | 0,495 |
| | 1,0 | 0,405 | 0,415 | 0,429 | 0,443 | 0,456 | 0,470 | 0,484 | 0,497 |
| | 0,8 | 0,409 | 0,419 | 0,432 | 0,446 | 0,459 | 0,473 | 0,486 | 0,498 |
| | 0,6 | 0,416 | 0,425 | 0,438 | 0,451 | 0,464 | 0,476 | 0,489 | 0,500 |
| | 0,4 | 0,428 | 0,435 | 0,447 | 0,459 | 0,471 | 0,483 | 0,494 | 0,504 |
| | 0,2 | 0,456 | 0,460 | 0,469 | 0,479 | 0,488 | 0,498 | 0,506 | 0,513 |
| | | 0,1 | 0,2 | 0,3 | 0,4 | 0,5 | 0,6 | 0,7 | 0,8 |
| | | Space heating share [-] | | | | | | | |

Table 20 presents the primary energy factor of the ULTDH system with central GWHP and micro heat pumps for DHW production. Primary energy factor generally decreases with an increase of plot ratio and increase of space heating share. A higher primary energy factor is observed for higher DHW demand because more electricity used at decentral heat substations. This scenario has lower primary energy factors than the previous scenario because there is no correction of electricity consumption due to frosting and constant source temperatures.

Table 20 Primary energy factor-ULTDH_Micro_GWHP

| | | Primary energy factor-ULTDH_Micro_GWHP [MWh/MWh _h] | | | | | | | |
|----------------|-----|--|-------|-------|-------|-------|-------|-------|-------|
| Plot ratio [-] | 2,0 | 0,337 | 0,334 | 0,334 | 0,334 | 0,335 | 0,335 | 0,335 | 0,335 |
| | 1,8 | 0,339 | 0,335 | 0,334 | 0,335 | 0,335 | 0,336 | 0,336 | 0,336 |
| | 1,6 | 0,340 | 0,336 | 0,336 | 0,336 | 0,336 | 0,336 | 0,336 | 0,336 |
| | 1,4 | 0,342 | 0,337 | 0,337 | 0,337 | 0,337 | 0,337 | 0,337 | 0,337 |
| | 1,2 | 0,344 | 0,339 | 0,339 | 0,338 | 0,338 | 0,338 | 0,338 | 0,337 |
| | 1,0 | 0,347 | 0,342 | 0,341 | 0,340 | 0,340 | 0,340 | 0,339 | 0,338 |
| | 0,8 | 0,351 | 0,345 | 0,344 | 0,343 | 0,343 | 0,342 | 0,341 | 0,339 |
| | 0,6 | 0,356 | 0,350 | 0,348 | 0,347 | 0,346 | 0,345 | 0,343 | 0,341 |
| | 0,4 | 0,367 | 0,359 | 0,356 | 0,354 | 0,352 | 0,350 | 0,348 | 0,344 |
| | 0,2 | 0,391 | 0,380 | 0,375 | 0,371 | 0,367 | 0,363 | 0,358 | 0,352 |
| | | | 0,1 | 0,2 | 0,3 | 0,4 | 0,5 | 0,6 | 0,7 |
| | | Space heating share [-] | | | | | | | |

Table 21 shows the primary energy factor for the ULTDH system with a central heat exchanger (40°C excess heat) and micro heat pumps for DHW production. As space heating share increases, the primary energy factor decreases because there is less need for electricity as domestic hot water needs decrease and the central unit does not require electricity to operate. In this ULTDH subgroup, this case has the lowest overall primary energy factor.

Table 21 Primary energy factor-ULTDH_Micro_EH1HEX

| | | Primary energy factor-ULTDH_Micro_EH1HEX [MWh/MWh _h] | | | | | | | |
|----------------|-----|--|-------|-------|-------|-------|-------|-------|-------|
| Plot ratio [-] | 2,0 | 0,041 | 0,032 | 0,029 | 0,026 | 0,024 | 0,021 | 0,019 | 0,017 |
| | 1,8 | 0,041 | 0,032 | 0,029 | 0,026 | 0,024 | 0,021 | 0,019 | 0,017 |
| | 1,6 | 0,041 | 0,032 | 0,029 | 0,026 | 0,024 | 0,021 | 0,019 | 0,016 |
| | 1,4 | 0,041 | 0,032 | 0,029 | 0,026 | 0,024 | 0,021 | 0,019 | 0,016 |
| | 1,2 | 0,041 | 0,032 | 0,029 | 0,026 | 0,024 | 0,021 | 0,019 | 0,016 |
| | 1,0 | 0,041 | 0,032 | 0,029 | 0,026 | 0,023 | 0,021 | 0,018 | 0,016 |
| | 0,8 | 0,041 | 0,032 | 0,029 | 0,026 | 0,023 | 0,021 | 0,018 | 0,016 |
| | 0,6 | 0,042 | 0,032 | 0,028 | 0,026 | 0,023 | 0,021 | 0,018 | 0,016 |
| | 0,4 | 0,043 | 0,032 | 0,028 | 0,026 | 0,023 | 0,020 | 0,018 | 0,015 |
| | 0,2 | 0,045 | 0,033 | 0,028 | 0,026 | 0,023 | 0,020 | 0,018 | 0,015 |
| | | | 0,1 | 0,2 | 0,3 | 0,4 | 0,5 | 0,6 | 0,7 |
| | | Space heating share [-] | | | | | | | |

Table 22 and Table 23 depict cases of the ULTDH network with central heat pumps supplied with excess heat (30°C and 20°C). At consumer substations, micro heat pumps are located for DHW production. As space heating share and plot ratios increase primary energy factor decreases. The case with higher temperature excess heat has lower overall primary energy factors because a lower temperature lift at the central unit requires less electricity and less primary energy.

Table 22 Primary energy factor-ULTDH_Micro_EH2HP

| Primary energy factor-ULTDH_Micro_EH2HP [MWh/MWh _h] | | | | | | | | | |
|---|-----|-------------------------|-------|-------|-------|-------|-------|-------|-----|
| Plot ratio [-] | 2,0 | 0,275 | 0,270 | 0,270 | 0,270 | 0,270 | 0,270 | 0,270 | |
| | 1,8 | 0,276 | 0,271 | 0,271 | 0,271 | 0,271 | 0,271 | 0,270 | |
| | 1,6 | 0,277 | 0,272 | 0,272 | 0,271 | 0,271 | 0,271 | 0,270 | |
| | 1,4 | 0,278 | 0,273 | 0,273 | 0,272 | 0,272 | 0,272 | 0,271 | |
| | 1,2 | 0,280 | 0,275 | 0,274 | 0,274 | 0,273 | 0,273 | 0,272 | |
| | 1,0 | 0,282 | 0,277 | 0,276 | 0,275 | 0,275 | 0,274 | 0,273 | |
| | 0,8 | 0,286 | 0,279 | 0,278 | 0,277 | 0,276 | 0,275 | 0,274 | |
| | 0,6 | 0,290 | 0,283 | 0,282 | 0,280 | 0,279 | 0,278 | 0,276 | |
| | 0,4 | 0,298 | 0,290 | 0,288 | 0,286 | 0,284 | 0,282 | 0,280 | |
| | 0,2 | 0,318 | 0,307 | 0,303 | 0,299 | 0,296 | 0,292 | 0,288 | |
| | | 0,1 | 0,2 | 0,3 | 0,4 | 0,5 | 0,6 | 0,7 | 0,8 |
| | | Space heating share [-] | | | | | | | |

Table 23 Primary energy factor-ULTDH_Micro_EH3HP

| Primary energy factor-ULTDH_Micro_EH3HP [MWh/MWh _h] | | | | | | | | | |
|---|-----|-------------------------|-------|-------|-------|-------|-------|-------|-----|
| Plot ratio [-] | 2,0 | 0,315 | 0,310 | 0,310 | 0,311 | 0,311 | 0,311 | 0,311 | |
| | 1,8 | 0,316 | 0,311 | 0,311 | 0,311 | 0,312 | 0,312 | 0,311 | |
| | 1,6 | 0,317 | 0,312 | 0,312 | 0,312 | 0,312 | 0,312 | 0,312 | |
| | 1,4 | 0,319 | 0,314 | 0,313 | 0,313 | 0,313 | 0,313 | 0,312 | |
| | 1,2 | 0,321 | 0,316 | 0,315 | 0,315 | 0,314 | 0,314 | 0,313 | |
| | 1,0 | 0,323 | 0,318 | 0,317 | 0,316 | 0,316 | 0,315 | 0,314 | |
| | 0,8 | 0,327 | 0,321 | 0,320 | 0,319 | 0,318 | 0,317 | 0,316 | |
| | 0,6 | 0,332 | 0,326 | 0,324 | 0,323 | 0,322 | 0,320 | 0,319 | |
| | 0,4 | 0,342 | 0,334 | 0,331 | 0,329 | 0,327 | 0,325 | 0,323 | |
| | 0,2 | 0,364 | 0,353 | 0,348 | 0,345 | 0,341 | 0,337 | 0,332 | |
| | | 0,1 | 0,2 | 0,3 | 0,4 | 0,5 | 0,6 | 0,7 | 0,8 |
| | | Space heating share [-] | | | | | | | |

If the central unit (ASHP) is kept the same and the network configuration is varied, the following observations were made.

Table 24 shows primary energy factors for the ULTDH system with central ASHP and ASHP for DW at consumer substations. This scenario has higher factors than those in Table 21 because every unit uses air as a heat source, requiring more electricity to account for all of the defrosting. The lowest factor value is for plot ratio of 2 and SH share of 0,1. That means that decentral electricity consumption has less influence on primary energy factor than central unit's.

Table 24 Primary energy factor-ULTDH_Air_ASHP

| | | Primary energy factor-ULTDH_Air_ASHP [MWh/MWh _h] | | | | | | | |
|----------------|-------|--|-------|-------|-------|-------|-------|-------|--|
| Plot ratio [-] | | | | | | | | | |
| | 0,1 | 0,2 | 0,3 | 0,4 | 0,5 | 0,6 | 0,7 | 0,8 | |
| 2,0 | 0,495 | 0,498 | 0,502 | 0,505 | 0,508 | 0,511 | 0,514 | 0,517 | |
| 1,8 | 0,496 | 0,499 | 0,503 | 0,506 | 0,509 | 0,512 | 0,515 | 0,517 | |
| 1,6 | 0,498 | 0,501 | 0,504 | 0,507 | 0,510 | 0,513 | 0,515 | 0,517 | |
| 1,4 | 0,500 | 0,503 | 0,506 | 0,509 | 0,511 | 0,514 | 0,516 | 0,518 | |
| 1,2 | 0,502 | 0,505 | 0,508 | 0,510 | 0,513 | 0,515 | 0,517 | 0,519 | |
| 1,0 | 0,505 | 0,508 | 0,510 | 0,513 | 0,515 | 0,517 | 0,519 | 0,520 | |
| 0,8 | 0,509 | 0,512 | 0,514 | 0,516 | 0,518 | 0,519 | 0,521 | 0,521 | |
| 0,6 | 0,516 | 0,518 | 0,519 | 0,521 | 0,522 | 0,523 | 0,524 | 0,524 | |
| 0,4 | 0,527 | 0,528 | 0,529 | 0,529 | 0,529 | 0,529 | 0,529 | 0,528 | |
| 0,2 | 0,553 | 0,552 | 0,551 | 0,549 | 0,547 | 0,544 | 0,541 | 0,537 | |

Table 25 shows the ULTDH system with central ASHP and booster heat pumps at the building level for DHW production. Here results are the same as the results of the ULTDH network with micro heat pumps and central ASHP shown in Table 19. The reason for that these scenarios have the same production of heat at the central and decentral level (the same equation).

Table 25 Primary energy factor-ULTDH_Booster_ASHP

| | | Primary energy factor-ULTDH_Booster_ASHP [MWh/MWh _h] | | | | | | | |
|----------------|-------|--|-------|-------|-------|-------|-------|-------|--|
| Plot ratio [-] | | | | | | | | | |
| | 0,1 | 0,2 | 0,3 | 0,4 | 0,5 | 0,6 | 0,7 | 0,8 | |
| 2,0 | 0,394 | 0,406 | 0,420 | 0,435 | 0,450 | 0,464 | 0,479 | 0,493 | |
| 1,8 | 0,396 | 0,407 | 0,421 | 0,436 | 0,451 | 0,465 | 0,480 | 0,494 | |
| 1,6 | 0,397 | 0,408 | 0,422 | 0,437 | 0,452 | 0,466 | 0,480 | 0,494 | |
| 1,4 | 0,399 | 0,410 | 0,424 | 0,438 | 0,453 | 0,467 | 0,481 | 0,495 | |
| 1,2 | 0,402 | 0,412 | 0,426 | 0,440 | 0,454 | 0,468 | 0,482 | 0,495 | |
| 1,0 | 0,405 | 0,415 | 0,429 | 0,443 | 0,456 | 0,470 | 0,484 | 0,497 | |
| 0,8 | 0,409 | 0,419 | 0,432 | 0,446 | 0,459 | 0,473 | 0,486 | 0,498 | |
| 0,6 | 0,416 | 0,425 | 0,438 | 0,451 | 0,464 | 0,476 | 0,489 | 0,500 | |
| 0,4 | 0,428 | 0,435 | 0,447 | 0,459 | 0,471 | 0,483 | 0,494 | 0,504 | |
| 0,2 | 0,456 | 0,460 | 0,469 | 0,479 | 0,488 | 0,498 | 0,506 | 0,513 | |

Table 26 shows the primary energy factor of the LTDH network with central ASHP. This system has the highest primary energy factors among all low and ultra-low temperature district heating systems. Higher heat losses and the highest central ASHP heat production rate adjusted with defrosting factor resulted in such high values of a factor. Here, the lowest primary energy factor is observed for high plot ratios and low space heating shares.

Table 26 Primary energy factor-LTDH_ASHP

| | | Primary energy factor-LTDH_ASHP [MWh/MWh _h] | | | | | | | |
|----------------|-----|---|-------|-------|-------|-------|-------|-------|-------|
| Plot ratio [-] | 2,0 | 0,559 | 0,568 | 0,581 | 0,596 | 0,610 | 0,624 | 0,637 | 0,650 |
| | 1,8 | 0,562 | 0,570 | 0,584 | 0,598 | 0,612 | 0,625 | 0,639 | 0,651 |
| | 1,6 | 0,565 | 0,573 | 0,587 | 0,600 | 0,614 | 0,627 | 0,640 | 0,653 |
| | 1,4 | 0,570 | 0,577 | 0,590 | 0,604 | 0,617 | 0,630 | 0,642 | 0,654 |
| | 1,2 | 0,575 | 0,582 | 0,594 | 0,607 | 0,620 | 0,633 | 0,645 | 0,656 |
| | 1,0 | 0,582 | 0,589 | 0,600 | 0,613 | 0,625 | 0,637 | 0,648 | 0,658 |
| | 0,8 | 0,592 | 0,597 | 0,608 | 0,620 | 0,631 | 0,642 | 0,653 | 0,662 |
| | 0,6 | 0,607 | 0,610 | 0,620 | 0,630 | 0,641 | 0,650 | 0,659 | 0,667 |
| | 0,4 | 0,632 | 0,632 | 0,640 | 0,648 | 0,657 | 0,664 | 0,671 | 0,676 |
| | 0,2 | 0,691 | 0,685 | 0,687 | 0,691 | 0,694 | 0,696 | 0,697 | 0,696 |
| | | 0,1 | 0,2 | 0,3 | 0,4 | 0,5 | 0,6 | 0,7 | 0,8 |
| | | Space heating share [-] | | | | | | | |

The lowest primary energy factors are calculated for ULTDH networks with a decentral booster and decentral micro heat pumps, as shown in Table 27. The reason for that is the lower electricity consumption of the central unit and higher source temperatures in decentral HPs. for DHW production.

Table 27 The lowest primary energy factor

| | | The Lowest Primary energy factor [MWh/MWh _h] | | | | | | | |
|----------------|-----|--|---------------|---------------|---------------|---------------|---------------|---------------|---------------|
| Plot ratio [-] | 2,0 | Booster/Micro | Booster/Micro | Booster/Micro | Booster/Micro | Booster/Micro | Booster/Micro | Booster/Micro | Booster/Micro |
| | 1,8 | Booster/Micro | Booster/Micro | Booster/Micro | Booster/Micro | Booster/Micro | Booster/Micro | Booster/Micro | Booster/Micro |
| | 1,6 | Booster/Micro | Booster/Micro | Booster/Micro | Booster/Micro | Booster/Micro | Booster/Micro | Booster/Micro | Booster/Micro |
| | 1,4 | Booster/Micro | Booster/Micro | Booster/Micro | Booster/Micro | Booster/Micro | Booster/Micro | Booster/Micro | Booster/Micro |
| | 1,2 | Booster/Micro | Booster/Micro | Booster/Micro | Booster/Micro | Booster/Micro | Booster/Micro | Booster/Micro | Booster/Micro |
| | 1,0 | Booster/Micro | Booster/Micro | Booster/Micro | Booster/Micro | Booster/Micro | Booster/Micro | Booster/Micro | Booster/Micro |
| | 0,8 | Booster/Micro | Booster/Micro | Booster/Micro | Booster/Micro | Booster/Micro | Booster/Micro | Booster/Micro | Booster/Micro |
| | 0,6 | Booster/Micro | Booster/Micro | Booster/Micro | Booster/Micro | Booster/Micro | Booster/Micro | Booster/Micro | Booster/Micro |
| | 0,4 | Booster/Micro | Booster/Micro | Booster/Micro | Booster/Micro | Booster/Micro | Booster/Micro | Booster/Micro | Booster/Micro |
| | 0,2 | Booster/Micro | Booster/Micro | Booster/Micro | Booster/Micro | Booster/Micro | Booster/Micro | Booster/Micro | Booster/Micro |
| | | 0,1 | 0,2 | 0,3 | 0,4 | 0,5 | 0,6 | 0,7 | 0,8 |
| | | Space heating share [-] | | | | | | | |

5.3. CO₂ factor

CO₂ factor follows trends of primary energy factor. When more energy is used, more CO₂ emissions are released into the atmosphere. All cases have lower CO₂ factors than individual gas boiler's CO₂ factor. As in previous analyses, one system configuration is evaluated for different central units. Also, one central unit is analysed for different system configurations.

Table 28 shows CO₂ factor values for the ULTDH system with central ASHP and micro heat pumps for DHW at consumer substations. Higher values of factor are characteristic for higher space heating shares as more heat is produced in the central unit, and thus more electricity consumed, which increase CO₂ emissions. Central ASHP electricity consumption is more influenced by the defrosting factor than individual ASHPs.

Table 28 CO₂ factor-ULTDH_Micro_ASHP

| CO ₂ factor-ULTDH_Micro_ASHP [tCO ₂ /MWh _h] | | | | | | | | | |
|---|-----|-------------------------|-------|-------|-------|-------|-------|-------|-------|
| Plot ratio [-] | 2,0 | 0,057 | 0,059 | 0,061 | 0,063 | 0,065 | 0,068 | 0,070 | 0,072 |
| | 1,8 | 0,058 | 0,059 | 0,061 | 0,063 | 0,066 | 0,068 | 0,070 | 0,072 |
| | 1,6 | 0,058 | 0,059 | 0,061 | 0,064 | 0,066 | 0,068 | 0,070 | 0,072 |
| | 1,4 | 0,058 | 0,060 | 0,062 | 0,064 | 0,066 | 0,068 | 0,070 | 0,072 |
| | 1,2 | 0,058 | 0,060 | 0,062 | 0,064 | 0,066 | 0,068 | 0,070 | 0,072 |
| | 1,0 | 0,059 | 0,060 | 0,062 | 0,064 | 0,066 | 0,068 | 0,070 | 0,072 |
| | 0,8 | 0,060 | 0,061 | 0,063 | 0,065 | 0,067 | 0,069 | 0,071 | 0,072 |
| | 0,6 | 0,061 | 0,062 | 0,064 | 0,066 | 0,067 | 0,069 | 0,071 | 0,073 |
| | 0,4 | 0,062 | 0,063 | 0,065 | 0,067 | 0,069 | 0,070 | 0,072 | 0,073 |
| | 0,2 | 0,066 | 0,067 | 0,068 | 0,070 | 0,071 | 0,072 | 0,074 | 0,075 |
| | | 0,1 | 0,2 | 0,3 | 0,4 | 0,5 | 0,6 | 0,7 | 0,8 |
| | | Space heating share [-] | | | | | | | |

Table 29 shows CO₂ factors for the ULTDH network with central GWHP and micro heat pumps for DHW production at each apartment. Here, the highest values are in low space heating shares and low plot ratios. The cause is a higher share of DHW in that area and more electricity consumption, leading to higher CO₂ emissions.

Table 29 CO₂ factor-ULTDH_Micro_GWHP

| | | CO ₂ factor-ULTDH_Micro_GWHP [tCO ₂ /MWh _n] | | | | | | | |
|----------------|-----|---|-------|-------|-------|-------|-------|-------|-------|
| Plot ratio [-] | 2,0 | 0,049 | 0,049 | 0,049 | 0,049 | 0,049 | 0,049 | 0,049 | 0,049 |
| | 1,8 | 0,049 | 0,049 | 0,049 | 0,049 | 0,049 | 0,049 | 0,049 | 0,049 |
| | 1,6 | 0,049 | 0,049 | 0,049 | 0,049 | 0,049 | 0,049 | 0,049 | 0,049 |
| | 1,4 | 0,050 | 0,049 | 0,049 | 0,049 | 0,049 | 0,049 | 0,049 | 0,049 |
| | 1,2 | 0,050 | 0,049 | 0,049 | 0,049 | 0,049 | 0,049 | 0,049 | 0,049 |
| | 1,0 | 0,050 | 0,050 | 0,050 | 0,050 | 0,049 | 0,049 | 0,049 | 0,049 |
| | 0,8 | 0,051 | 0,050 | 0,050 | 0,050 | 0,050 | 0,050 | 0,050 | 0,049 |
| | 0,6 | 0,052 | 0,051 | 0,051 | 0,051 | 0,050 | 0,050 | 0,050 | 0,050 |
| | 0,4 | 0,053 | 0,052 | 0,052 | 0,052 | 0,051 | 0,051 | 0,051 | 0,050 |
| | 0,2 | 0,057 | 0,055 | 0,055 | 0,054 | 0,053 | 0,053 | 0,052 | 0,051 |
| | | 0,1 | 0,2 | 0,3 | 0,4 | 0,5 | 0,6 | 0,7 | 0,8 |
| | | Space heating share [-] | | | | | | | |

Table 30 depicts CO₂ factors for the ULTDH network with micro heat pumps for DHW preparation and central HEX with excess heat as a heat source. Here, as SH share increases CO₂ factor decreases because less electricity is needed for DHW production.

Table 30 CO₂ factor-ULTDH_Micro_EH1HEX

| | | CO ₂ factor-ULTDH_Micro_EH1HEX [tCO ₂ /MWh _n] | | | | | | | |
|----------------|-----|---|-------|-------|-------|-------|-------|-------|-------|
| Plot ratio [-] | 2,0 | 0,006 | 0,005 | 0,004 | 0,004 | 0,003 | 0,003 | 0,003 | 0,002 |
| | 1,8 | 0,006 | 0,005 | 0,004 | 0,004 | 0,003 | 0,003 | 0,003 | 0,002 |
| | 1,6 | 0,006 | 0,005 | 0,004 | 0,004 | 0,003 | 0,003 | 0,003 | 0,002 |
| | 1,4 | 0,006 | 0,005 | 0,004 | 0,004 | 0,003 | 0,003 | 0,003 | 0,002 |
| | 1,2 | 0,006 | 0,005 | 0,004 | 0,004 | 0,003 | 0,003 | 0,003 | 0,002 |
| | 1,0 | 0,006 | 0,005 | 0,004 | 0,004 | 0,003 | 0,003 | 0,003 | 0,002 |
| | 0,8 | 0,006 | 0,005 | 0,004 | 0,004 | 0,003 | 0,003 | 0,003 | 0,002 |
| | 0,6 | 0,006 | 0,005 | 0,004 | 0,004 | 0,003 | 0,003 | 0,003 | 0,002 |
| | 0,4 | 0,006 | 0,005 | 0,004 | 0,004 | 0,003 | 0,003 | 0,003 | 0,002 |
| | 0,2 | 0,007 | 0,005 | 0,004 | 0,004 | 0,003 | 0,003 | 0,003 | 0,002 |
| | | 0,1 | 0,2 | 0,3 | 0,4 | 0,5 | 0,6 | 0,7 | 0,8 |
| | | Space heating share [-] | | | | | | | |

CO₂ factors of ULTDH networks with micro heat pumps for DHW preparation and central heat pumps with excess heat at temperatures 30°C and 20°C are shown in Table 31 and Table 32, respectively.

Table 31 CO₂ factor-ULTDH_Micro_EH2HP

| CO ₂ factor-ULTDH_Micro_EH2HP [tCO ₂ /MWh _h] | | | | | | | | | |
|--|-----|-------------------------|-------|-------|-------|-------|-------|-------|-------|
| Plot ratio [-] | 2,0 | 0,040 | 0,039 | 0,039 | 0,039 | 0,039 | 0,039 | 0,039 | 0,039 |
| | 1,8 | 0,040 | 0,039 | 0,039 | 0,039 | 0,039 | 0,039 | 0,039 | 0,039 |
| | 1,6 | 0,040 | 0,040 | 0,040 | 0,039 | 0,039 | 0,039 | 0,039 | 0,039 |
| | 1,4 | 0,041 | 0,040 | 0,040 | 0,040 | 0,040 | 0,040 | 0,039 | 0,039 |
| | 1,2 | 0,041 | 0,040 | 0,040 | 0,040 | 0,040 | 0,040 | 0,040 | 0,039 |
| | 1,0 | 0,041 | 0,040 | 0,040 | 0,040 | 0,040 | 0,040 | 0,040 | 0,040 |
| | 0,8 | 0,042 | 0,041 | 0,040 | 0,040 | 0,040 | 0,040 | 0,040 | 0,040 |
| | 0,6 | 0,042 | 0,041 | 0,041 | 0,041 | 0,041 | 0,040 | 0,040 | 0,040 |
| | 0,4 | 0,043 | 0,042 | 0,042 | 0,042 | 0,041 | 0,041 | 0,041 | 0,040 |
| | 0,2 | 0,046 | 0,045 | 0,044 | 0,044 | 0,043 | 0,042 | 0,042 | 0,041 |
| | | 0,1 | 0,2 | 0,3 | 0,4 | 0,5 | 0,6 | 0,7 | 0,8 |
| | | Space heating share [-] | | | | | | | |

Table 32 CO₂ factor-ULTDH_Micro_EH3HP

| CO ₂ factor-ULTDH_Micro_EH3HP [tCO ₂ /MWh _h] | | | | | | | | | |
|--|-----|-------------------------|-------|-------|-------|-------|-------|-------|-------|
| Plot ratio [-] | 2,0 | 0,046 | 0,045 | 0,045 | 0,045 | 0,045 | 0,045 | 0,045 | 0,045 |
| | 1,8 | 0,046 | 0,045 | 0,045 | 0,045 | 0,045 | 0,045 | 0,045 | 0,045 |
| | 1,6 | 0,046 | 0,045 | 0,045 | 0,045 | 0,045 | 0,045 | 0,045 | 0,045 |
| | 1,4 | 0,046 | 0,046 | 0,046 | 0,046 | 0,046 | 0,046 | 0,046 | 0,045 |
| | 1,2 | 0,047 | 0,046 | 0,046 | 0,046 | 0,046 | 0,046 | 0,046 | 0,046 |
| | 1,0 | 0,047 | 0,046 | 0,046 | 0,046 | 0,046 | 0,046 | 0,046 | 0,046 |
| | 0,8 | 0,048 | 0,047 | 0,046 | 0,046 | 0,046 | 0,046 | 0,046 | 0,046 |
| | 0,6 | 0,048 | 0,047 | 0,047 | 0,047 | 0,047 | 0,047 | 0,046 | 0,046 |
| | 0,4 | 0,050 | 0,049 | 0,048 | 0,048 | 0,048 | 0,047 | 0,047 | 0,046 |
| | 0,2 | 0,053 | 0,051 | 0,051 | 0,050 | 0,050 | 0,049 | 0,048 | 0,048 |
| | | 0,1 | 0,2 | 0,3 | 0,4 | 0,5 | 0,6 | 0,7 | 0,8 |
| | | Space heating share [-] | | | | | | | |

As space heating share and plot ratio increase, the CO₂ factor decreases because less electricity for DHW production is needed. Lower temperature excess heat has higher overall CO₂ factors because more electricity needs to be consumed for a higher temperature lift. These factors are higher than those observed for excess heat with a heat exchanger as a central unit because electricity is needed for heat pumps. However, compared to central ASHP and GWHP in this system configuration, they have considerably lower CO₂ factors.

When the central heat source is kept the same (ASHP) and system configurations are varied, the following is noticed. Table 28 showed how CO₂ factors act in the system with central ASHP in the ULTDH network, with micro heat pumps for DHW. Table 33 shows how CO₂ factor changes in the ULTDH network with central ASHP and ASHPs for DHW production. Their trends are similar but, because ASHPs are in central and decentral units, the scenario depicted in Table 33 has higher overall CO₂ factors because it needs more electricity for any space heating share.

Table 33 CO₂ factor-ULTDH_Air_ASHP

| | | CO ₂ factor-ULTDH_Air_ASHP [tCO ₂ /MWh _h] | | | | | | | |
|----------------|-----|---|-------|-------|-------|-------|-------|-------|-------|
| Plot ratio [-] | 2,0 | 0,072 | 0,072 | 0,073 | 0,073 | 0,074 | 0,074 | 0,075 | 0,075 |
| | 1,8 | 0,072 | 0,073 | 0,073 | 0,074 | 0,074 | 0,074 | 0,075 | 0,075 |
| | 1,6 | 0,072 | 0,073 | 0,073 | 0,074 | 0,074 | 0,075 | 0,075 | 0,075 |
| | 1,4 | 0,073 | 0,073 | 0,074 | 0,074 | 0,074 | 0,075 | 0,075 | 0,075 |
| | 1,2 | 0,073 | 0,073 | 0,074 | 0,074 | 0,075 | 0,075 | 0,075 | 0,075 |
| | 1,0 | 0,073 | 0,074 | 0,074 | 0,075 | 0,075 | 0,075 | 0,075 | 0,076 |
| | 0,8 | 0,074 | 0,074 | 0,075 | 0,075 | 0,075 | 0,076 | 0,076 | 0,076 |
| | 0,6 | 0,075 | 0,075 | 0,076 | 0,076 | 0,076 | 0,076 | 0,076 | 0,076 |
| | 0,4 | 0,077 | 0,077 | 0,077 | 0,077 | 0,077 | 0,077 | 0,077 | 0,077 |
| | 0,2 | 0,080 | 0,080 | 0,080 | 0,080 | 0,080 | 0,079 | 0,079 | 0,078 |
| | | 0,1 | 0,2 | 0,3 | 0,4 | 0,5 | 0,6 | 0,7 | 0,8 |
| | | Space heating share [-] | | | | | | | |

Table 34 shows the ULTDH network with central ASHP and booster heat pumps for DHW production. Carbon emission factors are the same as in the micro heat pumps case because they produce the same amount of heat in central and decentral units. Thus, they consume the same amount of electricity and release the same CO₂ emission into the atmosphere.

Table 34 CO₂ factor-ULTDH_Booster_ASHP

| | | CO ₂ factor-ULTDH_Booster_ASHP [tCO ₂ /MWh _n] | | | | | | | |
|----------------|-----|---|-------|-------|-------|-------|-------|-------|-------|
| Plot ratio [-] | 2,0 | 0,057 | 0,059 | 0,061 | 0,063 | 0,065 | 0,068 | 0,070 | 0,072 |
| | 1,8 | 0,058 | 0,059 | 0,061 | 0,063 | 0,066 | 0,068 | 0,070 | 0,072 |
| | 1,6 | 0,058 | 0,059 | 0,061 | 0,064 | 0,066 | 0,068 | 0,070 | 0,072 |
| | 1,4 | 0,058 | 0,060 | 0,062 | 0,064 | 0,066 | 0,068 | 0,070 | 0,072 |
| | 1,2 | 0,058 | 0,060 | 0,062 | 0,064 | 0,066 | 0,068 | 0,070 | 0,072 |
| | 1,0 | 0,059 | 0,060 | 0,062 | 0,064 | 0,066 | 0,068 | 0,070 | 0,072 |
| | 0,8 | 0,060 | 0,061 | 0,063 | 0,065 | 0,067 | 0,069 | 0,071 | 0,072 |
| | 0,6 | 0,061 | 0,062 | 0,064 | 0,066 | 0,067 | 0,069 | 0,071 | 0,073 |
| | 0,4 | 0,062 | 0,063 | 0,065 | 0,067 | 0,069 | 0,070 | 0,072 | 0,073 |
| | 0,2 | 0,066 | 0,067 | 0,068 | 0,070 | 0,071 | 0,072 | 0,074 | 0,075 |
| | | 0,1 | 0,2 | 0,3 | 0,4 | 0,5 | 0,6 | 0,7 | 0,8 |
| | | Space heating share [-] | | | | | | | |

Table 35 shows the CO₂ factors of the LTDH network with central ASHP. As shown earlier, more heat requires more electricity consumption in heat pumps which causes an increase in CO₂ factors. Also, frosting problems increase electricity consumption.

Table 35 CO₂ factor-LTDH_ASHP

| | | CO ₂ factor-LTDH_ASHP [tCO ₂ /MWh _n] | | | | | | | |
|----------------|-----|--|-------|-------|-------|-------|-------|-------|-------|
| Plot ratio [-] | 2,0 | 0,081 | 0,083 | 0,085 | 0,087 | 0,089 | 0,091 | 0,093 | 0,095 |
| | 1,8 | 0,082 | 0,083 | 0,085 | 0,087 | 0,089 | 0,091 | 0,093 | 0,095 |
| | 1,6 | 0,082 | 0,083 | 0,085 | 0,087 | 0,089 | 0,091 | 0,093 | 0,095 |
| | 1,4 | 0,083 | 0,084 | 0,086 | 0,088 | 0,090 | 0,092 | 0,093 | 0,095 |
| | 1,2 | 0,084 | 0,085 | 0,086 | 0,088 | 0,090 | 0,092 | 0,094 | 0,095 |
| | 1,0 | 0,085 | 0,086 | 0,087 | 0,089 | 0,091 | 0,093 | 0,094 | 0,096 |
| | 0,8 | 0,086 | 0,087 | 0,088 | 0,090 | 0,092 | 0,093 | 0,095 | 0,096 |
| | 0,6 | 0,088 | 0,089 | 0,090 | 0,092 | 0,093 | 0,095 | 0,096 | 0,097 |
| | 0,4 | 0,092 | 0,092 | 0,093 | 0,094 | 0,096 | 0,097 | 0,098 | 0,098 |
| | 0,2 | 0,101 | 0,100 | 0,100 | 0,100 | 0,101 | 0,101 | 0,101 | 0,101 |
| | | 0,1 | 0,2 | 0,3 | 0,4 | 0,5 | 0,6 | 0,7 | 0,8 |
| | | Space heating share [-] | | | | | | | |

All cases have lower CO₂ factors compared to individual natural gas boiler heating CO₂ factor of 0,242. The lowest CO₂ factors are observed for ULTDH networks with a booster and micro heat pumps at consumer substations, as shown in Table 36. They consume less electricity than other cases. Less electricity consumption is caused by less needed heat production in the central unit and lower temperature lift at the decentral units.

Table 36 The lowest carbon emission factor

| | | The Lowest CO ₂ factor [tCO ₂ /MWh _n] | | | | | | | |
|----------------|-----|---|---------------|---------------|---------------|---------------|---------------|---------------|---------------|
| Plot ratio [-] | 2,0 | Booster/Micro | Booster/Micro | Booster/Micro | Booster/Micro | Booster/Micro | Booster/Micro | Booster/Micro | Booster/Micro |
| | 1,8 | Booster/Micro | Booster/Micro | Booster/Micro | Booster/Micro | Booster/Micro | Booster/Micro | Booster/Micro | Booster/Micro |
| | 1,6 | Booster/Micro | Booster/Micro | Booster/Micro | Booster/Micro | Booster/Micro | Booster/Micro | Booster/Micro | Booster/Micro |
| | 1,4 | Booster/Micro | Booster/Micro | Booster/Micro | Booster/Micro | Booster/Micro | Booster/Micro | Booster/Micro | Booster/Micro |
| | 1,2 | Booster/Micro | Booster/Micro | Booster/Micro | Booster/Micro | Booster/Micro | Booster/Micro | Booster/Micro | Booster/Micro |
| | 1,0 | Booster/Micro | Booster/Micro | Booster/Micro | Booster/Micro | Booster/Micro | Booster/Micro | Booster/Micro | Booster/Micro |
| | 0,8 | Booster/Micro | Booster/Micro | Booster/Micro | Booster/Micro | Booster/Micro | Booster/Micro | Booster/Micro | Booster/Micro |
| | 0,6 | Booster/Micro | Booster/Micro | Booster/Micro | Booster/Micro | Booster/Micro | Booster/Micro | Booster/Micro | Booster/Micro |
| | 0,4 | Booster/Micro | Booster/Micro | Booster/Micro | Booster/Micro | Booster/Micro | Booster/Micro | Booster/Micro | Booster/Micro |
| | 0,2 | Booster/Micro | Booster/Micro | Booster/Micro | Booster/Micro | Booster/Micro | Booster/Micro | Booster/Micro | Booster/Micro |
| | | 0,1 | 0,2 | 0,3 | 0,4 | 0,5 | 0,6 | 0,7 | 0,8 |
| | | Space heating share [-] | | | | | | | |

6. CONCLUSION

After conduction of cost and benefit analysis of low and ultra-low temperature district heating systems following was observed. Low plot ratios and space heating shares make these new networks infeasible compared to individual natural gas boiler heating. However, if technology advancements continue at the current pace, the cost of this system could be significantly reduced and more competitive in those areas. It has been shown that network investment accounts only for a fraction of total cost and that the most significant portion of investment cost comes from central and decentral heat pumps. Also, in cases where heat pumps are in each apartment, operation and maintenance costs and electricity cost increase significantly, affecting the profitability of these systems. At higher plot ratios (urban, densely populated area), these systems are profitable if domestic hot water demand is low compared to space heating demand. That also supports the fact that decentral heat pumps are the main expenditure in these networks. All that means that currently, reduction of network losses and reduction of fuel cost in these networks cannot cover the costs of extra equipment and electricity in any district. LTDH networks perform slightly better because they do not need decentral heat pumps, and heat losses are low enough still low enough despite higher temperatures than in ULTDH systems. However, these systems are still not cost-competitive to individual heating solutions in rural areas with highly efficient buildings whose space heating need is only a fraction of their domestic hot water need. The lowest LCOH cost has been noticed in cases where district heating systems are supplied with excess heat. Nevertheless, excess heat is not available at any location, and ASHPs and GWHPs must be used, affecting profitability.

The primary energy factor and CO₂ factor showed that these systems help reduce energy consumption and CO₂ emissions compared to fossil fuel heating. All ULTDH and LTDH variants examined in this thesis showed better factors value than individual gas boiler heating. The lowest values are observed for ULTDH cases where the network acts as a source for decentral heat pumps.

Overall, these systems are great for energy conservation and CO₂ reduction, but they are still not feasible as other heating sources. To boost ULTDH and LTDH systems, heat pumps and electricity cost must drop.

ACKNOWLEDGEMENT

This Master's thesis was developed as the part of REWARDHeat project (Grant Agreement number 857811) financed through Horizon2020 Programme.

LITERATURE

- [1] H. Lund *et al.*, “4th Generation District Heating (4GDH). Integrating smart thermal grids into future sustainable energy systems.,” *Energy*, vol. 68, pp. 1–11, 2014.
- [2] S. Buffa, M. Cozzini, M. D’Antoni, M. Baratieri, and R. Fedrizzi, “5th generation district heating and cooling systems: A review of existing cases in Europe,” *Renewable and Sustainable Energy Reviews*. 2019.
- [3] T. Ommen, J. E. Thorsen, W. B. Markussen, and B. Elmegaard, “Performance of ultra low temperature district heating systems with utility plant and booster heat pumps,” *Energy*, vol. 137, pp. 544–555, 2017.
- [4] H. Li *et al.*, “Annex X Final report Toward 4 th Generation District Heating : Experience and Potential of Low-Temperature District Heating,” *IEA Annex X*, p. 205, 2014.
- [5] N. L. Shrestha *et al.*, “Implementation of large solar thermal system into district heating network in Chemnitz (Germany),” *ISES Sol. World Congr. 2017 - IEA SHC Int. Conf. Sol. Heat. Cool. Build. Ind. 2017, Proc.*, pp. 322–332, 2017.
- [6] H. Fang, J. Xia, K. Zhu, Y. Su, and Y. Jiang, “Industrial waste heat utilisation for low temperature district heating,” *Energy Policy*, vol. 62, pp. 236–246, 2013.
- [7] D. Schmidt and A. Kallert, *International Energy Agency Technology Collaboration Programme on District Heating and Cooling including Combined Heat and Power Annex TSI Low Temperature District Heating for Future Energy Systems FUTURE LOW TEMPERATURE DISTRICT HEATING DESIGN GUIDEBOOK. .*
- [8] A. Volkova *et al.*, “Energy cascade connection of a low-temperature district heating network to the return line of a high-temperature district heating network,” *Energy*, vol. 198, 2020.
- [9] D. Trier, L. Laurberg Jensen, F. Bava, I. Ben Hassine, and X. Jobard, “Large Storage Systems for DHC Networks,” p. 106, 2019.
- [10] M. Cozzini *et al.*, “FLEXYNETS Guide Book on Fifth generation, low temperature, high exergy district heating and cooling networks,” no. December, 2018.
- [11] D. Schmidt *et al.*, “Low Temperature District Heating for Future Energy Systems,” in *Energy Procedia*, 2017.
- [12] S. Chicherin, V. Mašatin, A. Siirde, and A. Volkova, “Method for assessing heat loss in

- a district heating network with a focus on the state of insulation and actual demand for useful energy,” *Energies*, vol. 13, no. 17, 2020.
- [13] O. Ruhnau, L. Hirth, and A. Praktijnjo, “Time series of heat demand and heat pump efficiency for energy system modeling,” *Sci. Data*, vol. 6, no. 1, pp. 1–10, 2019.
- [14] M. Therm, M. Caramaschi, M. Therm, K. Bryder, and L. Buhl, “Interconnection schemes for consumer installations,” no. 768567, pp. 1–62, 2019.
- [15] W. Meesenburg, T. Ommen, J. E. Thorsen, and B. Elmegaard, “Economic feasibility of ultra-low temperature district heating systems in newly built areas supplied by renewable energy,” *Energy*, vol. 191, p. 116496, 2020.
- [16] U. Persson and S. Werner, “Heat distribution and the future competitiveness of district heating,” *Appl. Energy*, vol. 88, no. 3, pp. 568–576, 2011.
- [17] U. Persson and S. Werner, “Effective width - The relative demand for district heating pipe lengths in city areas,” *12th Int. Symp. Dist. Heat. Cool.*, pp. 128–131, 2010.
- [18] “Danish District Heating Statistics 2017.” [Online]. Available: <https://www.danskfjernvarme.dk/viden/statistik-subsection/aarsstatistik/statistik-2017>. [Accessed: 29-Apr-2021].
- [19] Euroheat & power, “Guidelines for District Heating Substations,” *Euroheat & Power*, p. 68, 2008.
- [20] I. Sarbu and E. S. Valea, “Energy savings potential for pumping water in district heating stations,” *Sustain.*, vol. 7, no. 5, pp. 5705–5719, 2015.
- [21] J. K. Jensen, T. Ommen, L. Reinholdt, W. B. Markussen, and B. Elmegaard, “Heat pump COP, part 2: Generalised COP estimation of heat pump processes,” *Refrig. Sci. Technol.*, vol. 2018-June, pp. 1255–1264, 2018.
- [22] G. Mader, *Economic analysis of air-water heat pump technologies with a screening method*. 2015.
- [23] S. Papavinasam, *Management*. 2014.
- [24] “Odluka o kamatnim stopama, diskontnoj (eskontnoj) stopi i naknadama Hrvatske narodne banke - HNB.” [Online]. Available: <https://www.hnb.hr/-/odluka-o-kamatnim-stopama-diskontnoj-eskontnoj-stopi-i-naknadama-hrvatske-narodne-banke>. [Accessed: 30-Apr-2021].
- [25] A. Pavlova, J. Hansen, H. Obermeyer, and I. Pavlova, “Geothermal heat in a heat pump

- use,” *IOP Conf. Ser. Earth Environ. Sci.*, vol. 43, no. 1, 2016.
- [26] “Data Platform – Open Power System Data.” [Online]. Available: https://data.open-power-system-data.org/weather_data/2020-09-16. [Accessed: 29-Apr-2021].
- [27] T. J. de Boer, “Optimisation of a District Heating Network with the Focus on Heat Loss,” p. 1, 2018.
- [28] J. C. Flores, O. Le Corre, B. Lacarrière, and V. Martin, “Study of a District Heating Substation Using the Return Water of the Main System To Service a Low-Temperature Secondary,” *Svenskfjärrvarme.Se*, no. September, 2014.
- [29] J. E. Thorsen and T. Ommen, “Field experience with ULTDH substation for multifamily building,” *Energy Procedia*, vol. 149, pp. 197–205, 2018.
- [30] R. Segers, “Equivalent full load hours for heating of reversible air-air heat pumps,” pp. 1–12, 2015.
- [31] C. Transition, “Stimulation of Sustainable Energy Production and Climate Transition,” no. December, 2020.
- [32] D. Korn and J. Walczyk, “Exactly What Is a Full Load Cooling Hour and Does Size Really Matter?,” pp. 1–12, 2016.
- [33] H. Pieper, T. Ommen, F. Buhler, B. Lava Paaske, B. Elmegaard, and W. Brix Markussen, “Allocation of investment costs for large-scale heat pumps supplying district heating,” *Energy Procedia*, vol. 147, no. June 2019, pp. 358–367, 2018.
- [34] Danish Energy Agency, “Technology Data,” no. 36, pp. 5–6, 2020.
- [35] I. Page, T. Data, and H. Installations, “Technology Data for Heating Installations.”
- [36] DEA, “District Heating Assessment Tool,” 2017.
- [37] M. Adolfsson and S. Rashid, “Life Cycle Assessment and Life Cycle Cost of Heat Exchangers A Case for Inter Terminals Sweden AB Located in Port of Gothenburg,” 2016.
- [38] J. Kim and I. Weidlich, “Identification of Individual District Heating Network Conditions using Equivalent Full Load Cycles,” *Energy Procedia*, vol. 116, pp. 343–350, 2017.
- [39] C. H. Hansen, O. Gudmundsson, and N. Detlefsen, “Cost efficiency of district heating for low energy buildings of the future,” *Energy*, vol. 177, pp. 77–86, 2019.
- [40] “Electricity price statistics - Statistics Explained.” [Online]. Available:

- https://ec.europa.eu/eurostat/statistics-explained/index.php/Electricity_price_statistics#Electricity_prices_for_household_consumers. [Accessed: 30-Apr-2021].
- [41] “Natural gas price statistics - Statistics Explained.” [Online]. Available: https://ec.europa.eu/eurostat/statistics-explained/index.php/Natural_gas_price_statistics. [Accessed: 30-Apr-2021].
- [42] Ministarstvo graditeljstva i prostornog uređenja, “Faktori primarne energije i emisija CO₂,” p. 2014, 2014.

ANNEX

- I. LCOH tables
- II. Primary energy factor tables
- III. CO₂ factor tables

| | | LCOH-ULTDH_Air_ASHP [€/MWh _h] | | | | | | | |
|----------------|-----|---|-------|-------|-------|-------------|-------------|-------------|-------------|
| Plot ratio [-] | 2,0 | 107,9 | 98,9 | 90,4 | 82,0 | 73,7 | 65,3 | 56,9 | 48,3 |
| | 1,8 | 110,3 | 101,0 | 92,2 | 83,6 | 75,0 | 66,4 | 57,7 | 48,9 |
| | 1,6 | 113,1 | 103,4 | 94,3 | 85,4 | 76,6 | 67,7 | 58,7 | 49,6 |
| | 1,4 | 116,9 | 106,7 | 97,1 | 87,8 | 78,6 | 69,3 | 60,0 | 50,5 |
| | 1,2 | 121,6 | 110,7 | 100,7 | 90,9 | 81,2 | 71,4 | 61,6 | 51,6 |
| | 1,0 | 128,3 | 116,5 | 105,6 | 95,1 | 84,8 | 74,4 | 63,9 | 53,2 |
| | 0,8 | 137,8 | 124,6 | 112,6 | 101,2 | 89,8 | 78,5 | 67,1 | 55,5 |
| | 0,6 | 153,5 | 138,0 | 124,2 | 111,1 | 98,2 | 85,3 | 72,3 | 59,1 |
| | 0,4 | 183,2 | 163,3 | 146,0 | 129,6 | 113,7 | 97,9 | 82,1 | 65,9 |
| | 0,2 | 269,3 | 236,4 | 208,5 | 182,7 | 158,0 | 133,7 | 109,4 | 84,7 |
| | | 0,1 | 0,2 | 0,3 | 0,4 | 0,5 | 0,6 | 0,7 | 0,8 |
| | | Space heating share [-] | | | | | | | |

| | | LCOH-ULTDH_Air_GWHP [€/MWh _h] | | | | | | | |
|----------------|-----|---|-------|-------|-------|-------------|-------------|-------------|-------------|
| Plot ratio [-] | 2,0 | 110,3 | 98,9 | 88,7 | 78,9 | 69,3 | 59,8 | 50,3 | 40,7 |
| | 1,8 | 113,3 | 101,4 | 90,8 | 80,7 | 70,8 | 61,0 | 51,2 | 41,3 |
| | 1,6 | 116,9 | 104,4 | 93,3 | 82,7 | 72,5 | 62,3 | 52,2 | 42,0 |
| | 1,4 | 121,7 | 108,3 | 96,5 | 85,5 | 74,7 | 64,1 | 53,6 | 43,0 |
| | 1,2 | 127,9 | 113,3 | 100,7 | 88,9 | 77,5 | 66,4 | 55,3 | 44,1 |
| | 1,0 | 136,8 | 120,4 | 106,6 | 93,9 | 81,6 | 69,6 | 57,7 | 45,8 |
| | 0,8 | 149,8 | 130,9 | 115,3 | 101,0 | 87,4 | 74,2 | 61,2 | 48,1 |
| | 0,6 | 171,9 | 148,7 | 129,9 | 113,1 | 97,2 | 81,9 | 66,9 | 52,0 |
| | 0,4 | 216,1 | 184,0 | 158,8 | 136,7 | 116,3 | 96,8 | 78,0 | 59,4 |
| | 0,2 | 354,2 | 294,1 | 248,4 | 209,5 | 174,4 | 141,8 | 110,9 | 81,0 |
| | | 0,1 | 0,2 | 0,3 | 0,4 | 0,5 | 0,6 | 0,7 | 0,8 |
| | | Space heating share [-] | | | | | | | |

| | | LCOH-ULTDH_Air_EH1HEX [€/MWh _h] | | | | | | | |
|----------------|-----|---|-------|-------|-------------|-------------|-------------|-------------|-------------|
| Plot ratio [-] | 2,0 | 98,3 | 87,8 | 77,4 | 67,0 | 56,6 | 46,0 | 35,4 | 24,6 |
| | 1,8 | 100,0 | 89,3 | 78,7 | 68,2 | 57,6 | 46,9 | 36,1 | 25,1 |
| | 1,6 | 101,8 | 90,9 | 80,2 | 69,5 | 58,7 | 47,8 | 36,8 | 25,6 |
| | 1,4 | 104,3 | 93,1 | 82,2 | 71,2 | 60,2 | 49,1 | 37,8 | 26,3 |
| | 1,2 | 107,3 | 95,8 | 84,5 | 73,3 | 62,0 | 50,6 | 39,0 | 27,2 |
| | 1,0 | 111,5 | 99,5 | 87,9 | 76,3 | 64,6 | 52,8 | 40,7 | 28,4 |
| | 0,8 | 117,2 | 104,6 | 92,4 | 80,3 | 68,1 | 55,7 | 43,1 | 30,1 |
| | 0,6 | 126,5 | 112,8 | 99,7 | 86,7 | 73,7 | 60,4 | 46,8 | 32,8 |
| | 0,4 | 142,9 | 127,3 | 112,7 | 98,1 | 83,6 | 68,7 | 53,5 | 37,7 |
| | 0,2 | 186,4 | 165,8 | 146,8 | 128,3 | 109,7 | 90,7 | 71,1 | 50,5 |
| | | 0,1 | 0,2 | 0,3 | 0,4 | 0,5 | 0,6 | 0,7 | 0,8 |
| | | Space heating share [-] | | | | | | | |

| | | LCOH-ULTDH_Air_EH2HP [€/MWh _h] | | | | | | | |
|----------------|-----|--|-------|-------|-------|-------|-------|------|------|
| Plot ratio [-] | 2,0 | 105,2 | 95,3 | 85,7 | 76,3 | 66,8 | 57,3 | 47,7 | 38,0 |
| | 1,8 | 107,4 | 97,2 | 87,5 | 77,8 | 68,1 | 58,4 | 48,6 | 38,6 |
| | 1,6 | 110,0 | 99,5 | 89,5 | 79,5 | 69,6 | 59,6 | 49,5 | 39,3 |
| | 1,4 | 113,5 | 102,6 | 92,1 | 81,8 | 71,5 | 61,2 | 50,8 | 40,1 |
| | 1,2 | 117,8 | 106,3 | 95,4 | 84,7 | 74,0 | 63,2 | 52,3 | 41,2 |
| | 1,0 | 123,9 | 111,6 | 100,0 | 88,7 | 77,4 | 66,0 | 54,5 | 42,8 |
| | 0,8 | 132,5 | 119,0 | 106,5 | 94,3 | 82,1 | 69,9 | 57,5 | 44,9 |
| | 0,6 | 146,6 | 131,3 | 117,2 | 103,5 | 89,9 | 76,3 | 62,5 | 48,4 |
| | 0,4 | 172,9 | 154,0 | 136,9 | 120,5 | 104,3 | 88,1 | 71,7 | 54,8 |
| | 0,2 | 247,7 | 218,5 | 192,7 | 168,4 | 144,6 | 121,0 | 97,1 | 72,6 |
| | | 0,1 | 0,2 | 0,3 | 0,4 | 0,5 | 0,6 | 0,7 | 0,8 |
| | | Space heating share [-] | | | | | | | |

| | | LCOH-ULTDH_Air_EH3HP [€/MWh _h] | | | | | | | |
|----------------|-----|--|-------|-------|-------|-------|-------|------|------|
| Plot ratio [-] | 2,0 | 105,5 | 95,8 | 86,5 | 77,2 | 68,0 | 58,6 | 49,3 | 39,7 |
| | 1,8 | 107,8 | 97,8 | 88,2 | 78,7 | 69,2 | 59,7 | 50,1 | 40,3 |
| | 1,6 | 110,4 | 100,1 | 90,2 | 80,5 | 70,7 | 60,9 | 51,0 | 41,0 |
| | 1,4 | 113,9 | 103,1 | 92,9 | 82,8 | 72,7 | 62,5 | 52,3 | 41,9 |
| | 1,2 | 118,2 | 106,9 | 96,2 | 85,6 | 75,1 | 64,5 | 53,8 | 43,0 |
| | 1,0 | 124,3 | 112,2 | 100,8 | 89,6 | 78,5 | 67,3 | 56,0 | 44,5 |
| | 0,8 | 132,9 | 119,7 | 107,3 | 95,3 | 83,3 | 71,3 | 59,1 | 46,6 |
| | 0,6 | 147,0 | 131,9 | 118,0 | 104,5 | 91,1 | 77,7 | 64,1 | 50,1 |
| | 0,4 | 173,4 | 154,7 | 137,8 | 121,6 | 105,6 | 89,5 | 73,3 | 56,6 |
| | 0,2 | 248,4 | 219,3 | 193,7 | 169,5 | 146,0 | 122,5 | 98,8 | 74,4 |
| | | 0,1 | 0,2 | 0,3 | 0,4 | 0,5 | 0,6 | 0,7 | 0,8 |
| | | Space heating share [-] | | | | | | | |

| | | LCOH-ULTDH_Micro_ASHP [€/MWh _h] | | | | | | | |
|----------------|-----|---|-------|-------|-------|-------|-------|-------|-------|
| Plot ratio [-] | 2,0 | 192,1 | 174,2 | 156,4 | 138,7 | 120,9 | 103,1 | 85,2 | 67,2 |
| | 1,8 | 194,4 | 176,2 | 158,2 | 140,2 | 122,2 | 104,2 | 86,1 | 67,8 |
| | 1,6 | 197,1 | 178,6 | 160,3 | 142,1 | 123,8 | 105,5 | 87,1 | 68,5 |
| | 1,4 | 200,6 | 181,7 | 163,1 | 144,5 | 125,8 | 107,1 | 88,4 | 69,4 |
| | 1,2 | 205,1 | 185,7 | 166,6 | 147,5 | 128,4 | 109,2 | 90,0 | 70,5 |
| | 1,0 | 211,3 | 191,2 | 171,4 | 151,7 | 132,0 | 112,2 | 92,3 | 72,1 |
| | 0,8 | 220,2 | 199,1 | 178,3 | 157,7 | 137,0 | 116,3 | 95,5 | 74,4 |
| | 0,6 | 234,7 | 212,0 | 189,7 | 167,5 | 145,3 | 123,1 | 100,7 | 78,0 |
| | 0,4 | 262,3 | 236,3 | 210,9 | 185,8 | 160,8 | 135,7 | 110,4 | 84,8 |
| | 0,2 | 341,5 | 306,0 | 271,7 | 238,0 | 204,6 | 171,2 | 137,7 | 103,6 |
| | | 0,1 | 0,2 | 0,3 | 0,4 | 0,5 | 0,6 | 0,7 | 0,8 |
| | | Space heating share [-] | | | | | | | |

| | | LCOH-ULTDH_Micro_GWHP [€/MWh _h] | | | | | | | |
|----------------|-----|---|-------|-------|-------|-------|-------|-------|-------------|
| Plot ratio [-] | 2,0 | 191,2 | 171,9 | 153,0 | 134,2 | 115,5 | 96,8 | 78,0 | 59,2 |
| | 1,8 | 193,8 | 174,2 | 155,0 | 135,9 | 116,9 | 97,9 | 78,9 | 59,8 |
| | 1,6 | 197,0 | 176,9 | 157,3 | 137,9 | 118,6 | 99,2 | 79,9 | 60,5 |
| | 1,4 | 201,2 | 180,6 | 160,5 | 140,6 | 120,8 | 101,0 | 81,3 | 61,4 |
| | 1,2 | 206,5 | 185,2 | 164,5 | 143,9 | 123,6 | 103,3 | 83,0 | 62,6 |
| | 1,0 | 214,2 | 191,8 | 170,1 | 148,7 | 127,5 | 106,5 | 85,4 | 64,2 |
| | 0,8 | 225,4 | 201,5 | 178,4 | 155,7 | 133,3 | 111,0 | 88,8 | 66,6 |
| | 0,6 | 244,3 | 217,7 | 192,2 | 167,3 | 142,9 | 118,6 | 94,5 | 70,4 |
| | 0,4 | 281,8 | 249,8 | 219,5 | 190,1 | 161,5 | 133,4 | 105,5 | 77,8 |
| | 0,2 | 398,7 | 349,1 | 303,2 | 259,7 | 218,0 | 177,5 | 138,1 | 99,3 |
| | | 0,1 | 0,2 | 0,3 | 0,4 | 0,5 | 0,6 | 0,7 | 0,8 |
| | | Space heating share [-] | | | | | | | |

| | | LCOH-ULTDH_Micro_EH1HEX [€/MWh _h] | | | | | | | |
|----------------|-----|---|-------|-------|-------|-------|-------|-------------|-------------|
| Plot ratio [-] | 2,0 | 167,7 | 149,4 | 131,3 | 113,2 | 95,1 | 76,8 | 58,5 | 40,0 |
| | 1,8 | 169,4 | 150,9 | 132,7 | 114,4 | 96,1 | 77,7 | 59,1 | 40,4 |
| | 1,6 | 171,2 | 152,6 | 134,2 | 115,7 | 97,2 | 78,6 | 59,9 | 41,0 |
| | 1,4 | 173,6 | 154,8 | 136,1 | 117,5 | 98,7 | 79,9 | 60,9 | 41,7 |
| | 1,2 | 176,6 | 157,4 | 138,5 | 119,6 | 100,6 | 81,5 | 62,1 | 42,6 |
| | 1,0 | 180,7 | 161,2 | 141,9 | 122,6 | 103,2 | 83,6 | 63,9 | 43,8 |
| | 0,8 | 186,3 | 166,3 | 146,5 | 126,6 | 106,7 | 86,6 | 66,2 | 45,5 |
| | 0,6 | 195,3 | 174,4 | 153,8 | 133,1 | 112,3 | 91,3 | 70,0 | 48,2 |
| | 0,4 | 211,2 | 188,8 | 166,7 | 144,6 | 122,3 | 99,7 | 76,7 | 53,1 |
| | 0,2 | 253,0 | 226,6 | 200,7 | 174,8 | 148,5 | 121,8 | 94,3 | 65,9 |
| | | 0,1 | 0,2 | 0,3 | 0,4 | 0,5 | 0,6 | 0,7 | 0,8 |
| | | Space heating share [-] | | | | | | | |

| | | LCOH-ULTDH_Micro_EH2HP [€/MWh _h] | | | | | | | |
|----------------|-----|--|-------|-------|-------|-------|-------|-------------|-------------|
| Plot ratio [-] | 2,0 | 185,4 | 166,8 | 148,4 | 130,1 | 111,7 | 93,2 | 74,6 | 55,9 |
| | 1,8 | 187,6 | 168,7 | 150,1 | 131,5 | 112,9 | 94,2 | 75,4 | 56,5 |
| | 1,6 | 190,1 | 171,0 | 152,1 | 133,3 | 114,4 | 95,5 | 76,4 | 57,2 |
| | 1,4 | 193,4 | 173,9 | 154,7 | 135,6 | 116,4 | 97,1 | 77,7 | 58,1 |
| | 1,2 | 197,5 | 177,6 | 158,0 | 138,4 | 118,8 | 99,1 | 79,2 | 59,2 |
| | 1,0 | 203,3 | 182,8 | 162,6 | 142,4 | 122,2 | 101,9 | 81,4 | 60,7 |
| | 0,8 | 211,5 | 190,1 | 169,0 | 148,0 | 127,0 | 105,8 | 84,5 | 62,8 |
| | 0,6 | 224,8 | 202,0 | 179,5 | 157,1 | 134,7 | 112,2 | 89,4 | 66,3 |
| | 0,4 | 249,6 | 224,1 | 199,0 | 174,1 | 149,1 | 124,0 | 98,6 | 72,8 |
| | 0,2 | 319,8 | 286,3 | 253,7 | 221,4 | 189,2 | 156,8 | 124,0 | 90,5 |
| | | 0,1 | 0,2 | 0,3 | 0,4 | 0,5 | 0,6 | 0,7 | 0,8 |
| | | Space heating share [-] | | | | | | | |

| | | LCOH-ULTDH_Micro_EH3HP [€/MWh _h] | | | | | | | |
|----------------|-----|--|-------|-------|-------|-------|-------|-------|-------------|
| Plot ratio [-] | 2,0 | 187,4 | 168,8 | 150,4 | 132,1 | 113,7 | 95,2 | 76,7 | 58,0 |
| | 1,8 | 189,6 | 170,7 | 152,2 | 133,6 | 115,0 | 96,3 | 77,5 | 58,6 |
| | 1,6 | 192,1 | 173,0 | 154,2 | 135,3 | 116,5 | 97,5 | 78,5 | 59,3 |
| | 1,4 | 195,4 | 176,0 | 156,8 | 137,6 | 118,4 | 99,1 | 79,7 | 60,1 |
| | 1,2 | 199,5 | 179,7 | 160,1 | 140,5 | 120,9 | 101,1 | 81,3 | 61,2 |
| | 1,0 | 205,3 | 184,9 | 164,7 | 144,5 | 124,3 | 104,0 | 83,5 | 62,8 |
| | 0,8 | 213,5 | 192,2 | 171,1 | 150,1 | 129,1 | 107,9 | 86,6 | 64,9 |
| | 0,6 | 226,9 | 204,1 | 181,6 | 159,3 | 136,8 | 114,3 | 91,5 | 68,4 |
| | 0,4 | 251,8 | 226,2 | 201,2 | 176,2 | 151,3 | 126,1 | 100,7 | 74,9 |
| | 0,2 | 322,1 | 288,6 | 256,0 | 223,7 | 191,4 | 159,0 | 126,2 | 92,7 |
| | | 0,1 | 0,2 | 0,3 | 0,4 | 0,5 | 0,6 | 0,7 | 0,8 |
| | | Space heating share [-] | | | | | | | |

| | | LCOH-ULTDH_Booster_ASHP [€/MWh _h] | | | | | | | |
|----------------|-----|---|-------|-------|-------------|-------------|-------------|-------------|-------------|
| Plot ratio [-] | 2,0 | 92,2 | 85,4 | 78,7 | 72,1 | 65,4 | 58,7 | 51,9 | 45,0 |
| | 1,8 | 94,5 | 87,4 | 80,5 | 73,7 | 66,8 | 59,8 | 52,8 | 45,6 |
| | 1,6 | 97,2 | 89,8 | 82,6 | 75,5 | 68,3 | 61,1 | 53,8 | 46,3 |
| | 1,4 | 100,8 | 93,0 | 85,4 | 77,9 | 70,4 | 62,8 | 55,1 | 47,2 |
| | 1,2 | 105,2 | 96,9 | 88,9 | 80,9 | 72,9 | 64,9 | 56,7 | 48,3 |
| | 1,0 | 111,5 | 102,5 | 93,8 | 85,1 | 76,5 | 67,8 | 59,0 | 49,9 |
| | 0,8 | 120,3 | 110,3 | 100,6 | 91,1 | 81,5 | 71,9 | 62,2 | 52,2 |
| | 0,6 | 134,9 | 123,3 | 112,0 | 100,9 | 89,9 | 78,7 | 67,4 | 55,8 |
| | 0,4 | 162,4 | 147,5 | 133,2 | 119,2 | 105,3 | 91,3 | 77,1 | 62,6 |
| | 0,2 | 241,8 | 217,4 | 194,2 | 171,6 | 149,2 | 126,9 | 104,4 | 81,5 |
| | | 0,1 | 0,2 | 0,3 | 0,4 | 0,5 | 0,6 | 0,7 | 0,8 |
| | | Space heating share [-] | | | | | | | |

| | | LCOH-ULTDH_Booster_GWHP [€/MWh _h] | | | | | | | |
|----------------|-----|---|-------|-------|-------------|-------------|-------------|-------------|-------------|
| Plot ratio [-] | 2,0 | 91,3 | 83,1 | 75,3 | 67,6 | 60,0 | 52,4 | 44,7 | 37,0 |
| | 1,8 | 94,0 | 85,4 | 77,3 | 69,3 | 61,4 | 53,5 | 45,6 | 37,6 |
| | 1,6 | 97,1 | 88,2 | 79,6 | 71,3 | 63,1 | 54,9 | 46,6 | 38,3 |
| | 1,4 | 101,3 | 91,8 | 82,8 | 74,0 | 65,3 | 56,6 | 48,0 | 39,2 |
| | 1,2 | 106,7 | 96,4 | 86,8 | 77,3 | 68,1 | 58,9 | 49,7 | 40,4 |
| | 1,0 | 114,3 | 103,1 | 92,5 | 82,2 | 72,1 | 62,1 | 52,1 | 42,1 |
| | 0,8 | 125,5 | 112,7 | 100,7 | 89,1 | 77,8 | 66,6 | 55,5 | 44,4 |
| | 0,6 | 144,5 | 129,0 | 114,6 | 100,8 | 87,4 | 74,3 | 61,3 | 48,3 |
| | 0,4 | 181,9 | 161,0 | 141,8 | 123,5 | 106,0 | 89,0 | 72,2 | 55,6 |
| | 0,2 | 299,0 | 260,6 | 225,7 | 193,3 | 162,6 | 133,3 | 104,9 | 77,2 |
| | | 0,1 | 0,2 | 0,3 | 0,4 | 0,5 | 0,6 | 0,7 | 0,8 |
| | | Space heating share [-] | | | | | | | |

| | | LCOH-ULTDH_Booster_EH1HEX [€/MWh _h] | | | | | | | |
|----------------|-----|---|-------|-------|-------|------|------|------|------|
| Plot ratio [-] | 2,0 | 67,8 | 60,6 | 53,6 | 46,6 | 39,6 | 32,4 | 25,2 | 17,8 |
| | 1,8 | 69,5 | 62,1 | 55,0 | 47,8 | 40,6 | 33,3 | 25,9 | 18,3 |
| | 1,6 | 71,3 | 63,8 | 56,5 | 49,1 | 41,7 | 34,2 | 26,6 | 18,8 |
| | 1,4 | 73,8 | 66,0 | 58,5 | 50,9 | 43,3 | 35,5 | 27,6 | 19,5 |
| | 1,2 | 76,7 | 68,6 | 60,8 | 53,0 | 45,1 | 37,1 | 28,8 | 20,4 |
| | 1,0 | 80,8 | 72,4 | 64,2 | 56,0 | 47,7 | 39,2 | 30,6 | 21,6 |
| | 0,8 | 86,4 | 77,4 | 68,8 | 60,0 | 51,2 | 42,2 | 32,9 | 23,3 |
| | 0,6 | 95,5 | 85,7 | 76,1 | 66,6 | 56,8 | 46,9 | 36,7 | 26,1 |
| | 0,4 | 111,3 | 100,0 | 89,0 | 78,0 | 66,8 | 55,3 | 43,4 | 30,9 |
| | 0,2 | 153,3 | 138,1 | 123,2 | 108,3 | 93,1 | 77,5 | 61,1 | 43,8 |
| | | 0,1 | 0,2 | 0,3 | 0,4 | 0,5 | 0,6 | 0,7 | 0,8 |
| | | Space heating share [-] | | | | | | | |

| | | LCOH-ULTDH_Booster_EH2HP [€/MWh _h] | | | | | | | |
|----------------|-----|--|-------|-------|-------|-------|-------|------|------|
| Plot ratio [-] | 2,0 | 85,5 | 78,0 | 70,7 | 63,4 | 56,1 | 48,8 | 41,3 | 33,7 |
| | 1,8 | 87,7 | 79,9 | 72,4 | 65,0 | 57,4 | 49,8 | 42,2 | 34,3 |
| | 1,6 | 90,2 | 82,2 | 74,4 | 66,7 | 58,9 | 51,1 | 43,1 | 35,0 |
| | 1,4 | 93,5 | 85,2 | 77,1 | 69,0 | 60,9 | 52,7 | 44,4 | 35,9 |
| | 1,2 | 97,6 | 88,8 | 80,3 | 71,8 | 63,3 | 54,7 | 45,9 | 37,0 |
| | 1,0 | 103,4 | 94,0 | 84,9 | 75,8 | 66,7 | 57,5 | 48,1 | 38,5 |
| | 0,8 | 111,6 | 101,3 | 91,3 | 81,4 | 71,5 | 61,4 | 51,2 | 40,6 |
| | 0,6 | 125,0 | 113,2 | 101,9 | 90,6 | 79,3 | 67,8 | 56,1 | 44,1 |
| | 0,4 | 149,7 | 135,3 | 121,3 | 107,5 | 93,6 | 79,6 | 65,3 | 50,6 |
| | 0,2 | 220,1 | 197,7 | 176,2 | 155,0 | 133,8 | 112,5 | 90,7 | 68,3 |
| | | 0,1 | 0,2 | 0,3 | 0,4 | 0,5 | 0,6 | 0,7 | 0,8 |
| | | Space heating share [-] | | | | | | | |

| | | LCOH-ULTDH_Booster_EH3HP [€/MWh _h] | | | | | | | |
|----------------|-----|--|-------|-------|-------|-------|-------|------|------|
| Plot ratio [-] | 2,0 | 87,5 | 80,0 | 72,7 | 65,5 | 58,2 | 50,8 | 43,4 | 35,8 |
| | 1,8 | 89,7 | 82,0 | 74,5 | 67,0 | 59,5 | 51,9 | 44,2 | 36,4 |
| | 1,6 | 92,2 | 84,2 | 76,5 | 68,7 | 61,0 | 53,1 | 45,2 | 37,1 |
| | 1,4 | 95,5 | 87,2 | 79,1 | 71,0 | 62,9 | 54,7 | 46,4 | 37,9 |
| | 1,2 | 99,6 | 90,9 | 82,4 | 73,9 | 65,4 | 56,7 | 48,0 | 39,0 |
| | 1,0 | 105,5 | 96,1 | 87,0 | 77,9 | 68,8 | 59,6 | 50,2 | 40,6 |
| | 0,8 | 113,6 | 103,4 | 93,4 | 83,5 | 73,6 | 63,5 | 53,3 | 42,7 |
| | 0,6 | 127,1 | 115,3 | 104,0 | 92,7 | 81,4 | 69,9 | 58,3 | 46,3 |
| | 0,4 | 151,9 | 137,4 | 123,5 | 109,6 | 95,8 | 81,7 | 67,4 | 52,7 |
| | 0,2 | 222,4 | 200,0 | 178,5 | 157,2 | 136,1 | 114,7 | 93,0 | 70,5 |
| | | 0,1 | 0,2 | 0,3 | 0,4 | 0,5 | 0,6 | 0,7 | 0,8 |
| | | Space heating share [-] | | | | | | | |

| | | LCOH-LTDH_ASHP [€/MWh _h] | | | | | | | |
|----------------|-----|--------------------------------------|-------|-------|-------|-------|-------|-------|------|
| Plot ratio [-] | 2,0 | 60,2 | 58,3 | 56,5 | 54,8 | 52,9 | 50,8 | 48,5 | 46,0 |
| | 1,8 | 62,8 | 60,6 | 58,6 | 56,6 | 54,5 | 52,2 | 49,6 | 46,8 |
| | 1,6 | 66,0 | 63,5 | 61,2 | 58,9 | 56,4 | 53,8 | 50,9 | 47,7 |
| | 1,4 | 70,0 | 67,1 | 64,5 | 61,7 | 58,9 | 55,9 | 52,6 | 48,9 |
| | 1,2 | 75,2 | 71,8 | 68,6 | 65,4 | 62,1 | 58,5 | 54,7 | 50,4 |
| | 1,0 | 82,2 | 78,1 | 74,3 | 70,4 | 66,3 | 62,1 | 57,5 | 52,5 |
| | 0,8 | 92,4 | 87,2 | 82,4 | 77,5 | 72,5 | 67,2 | 61,6 | 55,4 |
| | 0,6 | 108,6 | 101,8 | 95,3 | 88,8 | 82,1 | 75,2 | 67,9 | 60,0 |
| | 0,4 | 139,3 | 129,2 | 119,6 | 110,0 | 100,3 | 90,2 | 79,7 | 68,4 |
| | 0,2 | 224,8 | 205,3 | 186,7 | 168,2 | 149,7 | 130,9 | 111,5 | 91,0 |
| | | 0,1 | 0,2 | 0,3 | 0,4 | 0,5 | 0,6 | 0,7 | 0,8 |
| | | Space heating share [-] | | | | | | | |

| | | LCOH-LTDH_GWHP [€/MWh _h] | | | | | | | |
|----------------|-----|--------------------------------------|-------|-------|-------|-------|-------|-------|------|
| Plot ratio [-] | 2,0 | 57,3 | 53,9 | 50,9 | 48,0 | 45,0 | 41,9 | 38,7 | 35,3 |
| | 1,8 | 60,2 | 56,5 | 53,2 | 50,0 | 46,7 | 43,3 | 39,8 | 36,1 |
| | 1,6 | 63,9 | 59,7 | 56,0 | 52,4 | 48,8 | 45,1 | 41,2 | 37,0 |
| | 1,4 | 68,5 | 63,8 | 59,6 | 55,5 | 51,4 | 47,2 | 42,9 | 38,2 |
| | 1,2 | 74,5 | 69,1 | 64,2 | 59,5 | 54,8 | 50,0 | 45,0 | 39,8 |
| | 1,0 | 82,8 | 76,4 | 70,6 | 65,0 | 59,4 | 53,8 | 48,0 | 41,9 |
| | 0,8 | 95,2 | 87,2 | 80,0 | 73,0 | 66,2 | 59,3 | 52,2 | 44,9 |
| | 0,6 | 115,4 | 104,9 | 95,3 | 86,1 | 77,1 | 68,1 | 59,0 | 49,6 |
| | 0,4 | 155,5 | 139,7 | 125,2 | 111,5 | 98,2 | 85,1 | 72,0 | 58,6 |
| | 0,2 | 276,3 | 243,9 | 214,2 | 186,4 | 159,8 | 134,1 | 108,9 | 83,7 |
| | | 0,1 | 0,2 | 0,3 | 0,4 | 0,5 | 0,6 | 0,7 | 0,8 |
| | | Space heating share [-] | | | | | | | |

| | | LCOH-LTDH_EH1HP [€/MWh _h] | | | | | | | |
|----------------|-----|---------------------------------------|-------|-------|-------|-------|-------|------|------|
| Plot ratio [-] | 2,0 | 48,9 | 46,2 | 43,8 | 41,3 | 38,7 | 35,9 | 33,0 | 29,7 |
| | 1,8 | 51,4 | 48,4 | 45,8 | 43,1 | 40,2 | 37,2 | 34,0 | 30,4 |
| | 1,6 | 54,4 | 51,1 | 48,2 | 45,2 | 42,1 | 38,8 | 35,2 | 31,3 |
| | 1,4 | 58,1 | 54,5 | 51,2 | 47,9 | 44,4 | 40,8 | 36,8 | 32,5 |
| | 1,2 | 62,9 | 58,9 | 55,2 | 51,4 | 47,4 | 43,3 | 38,8 | 34,0 |
| | 1,0 | 69,5 | 64,8 | 60,4 | 56,0 | 51,5 | 46,6 | 41,5 | 35,9 |
| | 0,8 | 78,8 | 73,2 | 68,0 | 62,7 | 57,2 | 51,5 | 45,4 | 38,7 |
| | 0,6 | 93,7 | 86,6 | 80,0 | 73,2 | 66,3 | 59,1 | 51,4 | 43,1 |
| | 0,4 | 121,5 | 111,7 | 102,3 | 92,8 | 83,1 | 73,1 | 62,5 | 51,1 |
| | 0,2 | 197,7 | 179,9 | 162,8 | 145,8 | 128,5 | 110,7 | 92,1 | 72,3 |
| | | 0,1 | 0,2 | 0,3 | 0,4 | 0,5 | 0,6 | 0,7 | 0,8 |
| | | Space heating share [-] | | | | | | | |

| | | LCOH-LTDH_EH2HP [€/MWh _h] | | | | | | | |
|----------------|-----|---------------------------------------|-------|-------|-------|-------|-------|------|------|
| Plot ratio [-] | 2,0 | 51,1 | 48,3 | 45,9 | 43,4 | 40,8 | 38,0 | 35,0 | 31,7 |
| | 1,8 | 53,5 | 50,6 | 47,9 | 45,2 | 42,3 | 39,3 | 36,0 | 32,5 |
| | 1,6 | 56,5 | 53,3 | 50,3 | 47,3 | 44,2 | 40,9 | 37,3 | 33,4 |
| | 1,4 | 60,3 | 56,7 | 53,4 | 50,0 | 46,5 | 42,8 | 38,9 | 34,5 |
| | 1,2 | 65,1 | 61,1 | 57,3 | 53,5 | 49,5 | 45,4 | 40,9 | 36,0 |
| | 1,0 | 71,7 | 67,0 | 62,6 | 58,2 | 53,6 | 48,8 | 43,6 | 38,0 |
| | 0,8 | 81,1 | 75,5 | 70,2 | 64,9 | 59,4 | 53,6 | 47,5 | 40,8 |
| | 0,6 | 96,0 | 88,9 | 82,2 | 75,5 | 68,5 | 61,2 | 53,5 | 45,2 |
| | 0,4 | 123,9 | 114,0 | 104,6 | 95,1 | 85,4 | 75,3 | 64,7 | 53,2 |
| | 0,2 | 200,3 | 182,5 | 165,3 | 148,2 | 130,9 | 113,0 | 94,4 | 74,5 |
| | | 0,1 | 0,2 | 0,3 | 0,4 | 0,5 | 0,6 | 0,7 | 0,8 |
| | | Space heating share [-] | | | | | | | |

| | | LCOH-LTDH_EH3HP [€/MWh _h] | | | | | | | |
|----------------|-----|---------------------------------------|-------|-------|-------|-------|-------|------|------|
| Plot ratio [-] | 2,0 | 53,3 | 50,6 | 48,1 | 45,6 | 43,0 | 40,2 | 37,2 | 33,9 |
| | 1,8 | 55,8 | 52,8 | 50,1 | 47,4 | 44,5 | 41,5 | 38,2 | 34,6 |
| | 1,6 | 58,8 | 55,6 | 52,6 | 49,6 | 46,4 | 43,1 | 39,5 | 35,6 |
| | 1,4 | 62,6 | 59,0 | 55,7 | 52,3 | 48,8 | 45,1 | 41,1 | 36,7 |
| | 1,2 | 67,4 | 63,4 | 59,6 | 55,8 | 51,8 | 47,6 | 43,1 | 38,2 |
| | 1,0 | 74,0 | 69,3 | 64,9 | 60,5 | 55,9 | 51,0 | 45,8 | 40,2 |
| | 0,8 | 83,5 | 77,9 | 72,6 | 67,2 | 61,7 | 55,9 | 49,7 | 43,0 |
| | 0,6 | 98,4 | 91,3 | 84,6 | 77,8 | 70,8 | 63,5 | 55,8 | 47,4 |
| | 0,4 | 126,5 | 116,5 | 107,1 | 97,6 | 87,8 | 77,7 | 67,0 | 55,5 |
| | 0,2 | 203,1 | 185,2 | 168,0 | 150,9 | 133,5 | 115,5 | 96,8 | 76,9 |
| | | 0,1 | 0,2 | 0,3 | 0,4 | 0,5 | 0,6 | 0,7 | 0,8 |
| | | Space heating share [-] | | | | | | | |

| | | LCOH-Individual_ASHP [€/MWh _h] | | | | | | | |
|----------------|-----|--|------|------|------|------|------|------|------|
| Plot ratio [-] | 2,0 | 87,7 | 89,0 | 90,2 | 91,5 | 92,7 | 94,0 | 95,3 | 96,5 |
| | 1,8 | 87,6 | 88,9 | 90,2 | 91,5 | 92,7 | 94,0 | 95,2 | 96,5 |
| | 1,6 | 87,6 | 88,9 | 90,2 | 91,5 | 92,7 | 94,0 | 95,3 | 96,5 |
| | 1,4 | 87,7 | 89,0 | 90,2 | 91,5 | 92,7 | 94,0 | 95,3 | 96,5 |
| | 1,2 | 87,7 | 88,9 | 90,2 | 91,4 | 92,7 | 94,0 | 95,2 | 96,5 |
| | 1,0 | 87,7 | 89,1 | 90,3 | 91,5 | 92,7 | 94,0 | 95,3 | 96,5 |
| | 0,8 | 87,8 | 89,0 | 90,2 | 91,5 | 92,7 | 94,0 | 95,3 | 96,5 |
| | 0,6 | 87,9 | 88,9 | 90,4 | 91,6 | 92,7 | 94,0 | 95,2 | 96,5 |
| | 0,4 | 88,0 | 89,3 | 90,2 | 91,7 | 92,7 | 94,1 | 95,3 | 96,5 |
| | 0,2 | 88,6 | 89,3 | 90,6 | 92,0 | 92,7 | 94,3 | 95,5 | 96,6 |
| | | 0,1 | 0,2 | 0,3 | 0,4 | 0,5 | 0,6 | 0,7 | 0,8 |
| | | Space heating share [-] | | | | | | | |

| | | The Lowest LCOH [€/MWh _h] | | | | | | | |
|----------------|------|---------------------------------------|------|------|------|------|------|------|------|
| Plot ratio [-] | 2,0 | 48,9 | 46,2 | 43,8 | 41,3 | 38,7 | 32,4 | 25,2 | 17,8 |
| | 1,8 | 51,4 | 48,4 | 45,8 | 43,1 | 40,2 | 33,3 | 25,9 | 18,3 |
| | 1,6 | 54,4 | 51,1 | 48,2 | 45,2 | 41,7 | 34,2 | 26,6 | 18,8 |
| | 1,4 | 58,1 | 54,5 | 51,2 | 47,9 | 43,3 | 35,5 | 27,6 | 19,5 |
| | 1,2 | 62,9 | 58,9 | 55,2 | 51,4 | 45,1 | 37,1 | 28,8 | 20,4 |
| | 1,0 | 69,5 | 64,8 | 60,4 | 56,0 | 47,7 | 39,2 | 30,6 | 21,6 |
| | 0,8 | 75,1 | 73,2 | 68,0 | 60,0 | 51,2 | 42,2 | 32,9 | 23,3 |
| | 0,6 | 75,1 | 75,1 | 75,1 | 66,6 | 56,8 | 46,9 | 36,7 | 26,1 |
| | 0,4 | 75,1 | 75,1 | 75,1 | 75,1 | 66,8 | 55,3 | 43,4 | 30,9 |
| 0,2 | 75,1 | 75,1 | 75,1 | 75,1 | 75,1 | 75,1 | 61,1 | 43,8 | |
| | | 0,1 | 0,2 | 0,3 | 0,4 | 0,5 | 0,6 | 0,7 | 0,8 |
| | | Space heating share [-] | | | | | | | |

| | | The Lowest LCOH without the EH1 [€/MWh _h] | | | | | | | |
|----------------|------|---|------|------|------|------|------|------|------|
| Plot ratio [-] | 2,0 | 51,1 | 48,3 | 45,9 | 43,4 | 40,8 | 38,0 | 35,0 | 31,7 |
| | 1,8 | 53,5 | 50,6 | 47,9 | 45,2 | 42,3 | 39,3 | 36,0 | 32,5 |
| | 1,6 | 56,5 | 53,3 | 50,3 | 47,3 | 44,2 | 40,9 | 37,3 | 33,4 |
| | 1,4 | 60,3 | 56,7 | 53,4 | 50,0 | 46,5 | 42,8 | 38,9 | 34,5 |
| | 1,2 | 65,1 | 61,1 | 57,3 | 53,5 | 49,5 | 45,4 | 40,9 | 36,0 |
| | 1,0 | 71,7 | 67,0 | 62,6 | 58,2 | 53,6 | 48,8 | 43,6 | 38,0 |
| | 0,8 | 75,1 | 75,1 | 70,2 | 64,9 | 59,4 | 53,6 | 47,5 | 40,6 |
| | 0,6 | 75,1 | 75,1 | 75,1 | 75,1 | 68,5 | 61,2 | 53,5 | 44,1 |
| | 0,4 | 75,1 | 75,1 | 75,1 | 75,1 | 75,1 | 75,1 | 64,7 | 50,6 |
| 0,2 | 75,1 | 75,1 | 75,1 | 75,1 | 75,1 | 75,1 | 75,1 | 68,3 | |
| | | 0,1 | 0,2 | 0,3 | 0,4 | 0,5 | 0,6 | 0,7 | 0,8 |
| | | Space heating share [-] | | | | | | | |

| | | The Lowest LCOH without the EH [€/MWh _h] | | | | | | | |
|----------------|------|--|------|------|------|------|------|------|------|
| Plot ratio [-] | 2,0 | 57,3 | 53,9 | 50,9 | 48,0 | 45,0 | 41,9 | 38,7 | 35,3 |
| | 1,8 | 60,2 | 56,5 | 53,2 | 50,0 | 46,7 | 43,3 | 39,8 | 36,1 |
| | 1,6 | 63,9 | 59,7 | 56,0 | 52,4 | 48,8 | 45,1 | 41,2 | 37,0 |
| | 1,4 | 68,5 | 63,8 | 59,6 | 55,5 | 51,4 | 47,2 | 42,9 | 38,2 |
| | 1,2 | 74,5 | 69,1 | 64,2 | 59,5 | 54,8 | 50,0 | 45,0 | 39,8 |
| | 1,0 | 75,1 | 75,1 | 70,6 | 65,0 | 59,4 | 53,8 | 48,0 | 41,9 |
| | 0,8 | 75,1 | 75,1 | 75,1 | 73,0 | 66,2 | 59,3 | 52,2 | 44,4 |
| | 0,6 | 75,1 | 75,1 | 75,1 | 75,1 | 75,1 | 68,1 | 59,0 | 48,3 |
| | 0,4 | 75,1 | 75,1 | 75,1 | 75,1 | 75,1 | 75,1 | 72,0 | 55,6 |
| 0,2 | 75,1 | 75,1 | 75,1 | 75,1 | 75,1 | 75,1 | 75,1 | 75,1 | |
| | | 0,1 | 0,2 | 0,3 | 0,4 | 0,5 | 0,6 | 0,7 | 0,8 |
| | | Space heating share [-] | | | | | | | |

| Primary energy factor-ULTDH_Air_ASHP [MWh/MWh _n] | | | | | | | | | |
|--|-------|-------|-------|-------|-------|-------|-------|-------|-------|
| Plot ratio [-] | 2,0 | 0,495 | 0,498 | 0,502 | 0,505 | 0,508 | 0,511 | 0,514 | 0,517 |
| | 1,8 | 0,496 | 0,499 | 0,503 | 0,506 | 0,509 | 0,512 | 0,515 | 0,517 |
| | 1,6 | 0,498 | 0,501 | 0,504 | 0,507 | 0,510 | 0,513 | 0,515 | 0,517 |
| | 1,4 | 0,500 | 0,503 | 0,506 | 0,509 | 0,511 | 0,514 | 0,516 | 0,518 |
| | 1,2 | 0,502 | 0,505 | 0,508 | 0,510 | 0,513 | 0,515 | 0,517 | 0,519 |
| | 1,0 | 0,505 | 0,508 | 0,510 | 0,513 | 0,515 | 0,517 | 0,519 | 0,520 |
| | 0,8 | 0,509 | 0,512 | 0,514 | 0,516 | 0,518 | 0,519 | 0,521 | 0,521 |
| | 0,6 | 0,516 | 0,518 | 0,519 | 0,521 | 0,522 | 0,523 | 0,524 | 0,524 |
| | 0,4 | 0,527 | 0,528 | 0,529 | 0,529 | 0,529 | 0,529 | 0,529 | 0,528 |
| 0,2 | 0,553 | 0,552 | 0,551 | 0,549 | 0,547 | 0,544 | 0,541 | 0,537 | |
| | | 0,1 | 0,2 | 0,3 | 0,4 | 0,5 | 0,6 | 0,7 | 0,8 |
| Space heating share [-] | | | | | | | | | |

| Primary energy factor-ULTDH_Air_GWHP [MWh/MWh _n] | | | | | | | | | |
|--|-------|-------|-------|-------|-------|-------|-------|-------|-------|
| Plot ratio [-] | 2,0 | 0,473 | 0,458 | 0,443 | 0,428 | 0,413 | 0,398 | 0,382 | 0,367 |
| | 1,8 | 0,474 | 0,459 | 0,444 | 0,429 | 0,414 | 0,398 | 0,383 | 0,367 |
| | 1,6 | 0,475 | 0,460 | 0,445 | 0,430 | 0,414 | 0,399 | 0,383 | 0,367 |
| | 1,4 | 0,477 | 0,462 | 0,446 | 0,431 | 0,416 | 0,400 | 0,384 | 0,368 |
| | 1,2 | 0,479 | 0,463 | 0,448 | 0,432 | 0,417 | 0,401 | 0,385 | 0,369 |
| | 1,0 | 0,481 | 0,466 | 0,450 | 0,434 | 0,419 | 0,402 | 0,386 | 0,369 |
| | 0,8 | 0,485 | 0,469 | 0,453 | 0,437 | 0,421 | 0,405 | 0,388 | 0,371 |
| | 0,6 | 0,491 | 0,474 | 0,458 | 0,441 | 0,425 | 0,408 | 0,390 | 0,372 |
| | 0,4 | 0,500 | 0,483 | 0,466 | 0,448 | 0,431 | 0,413 | 0,395 | 0,376 |
| 0,2 | 0,522 | 0,503 | 0,484 | 0,465 | 0,446 | 0,426 | 0,405 | 0,384 | |
| | | 0,1 | 0,2 | 0,3 | 0,4 | 0,5 | 0,6 | 0,7 | 0,8 |
| Space heating share [-] | | | | | | | | | |

| Primary energy factor-ULTDH_Air_EH1HEX [MWh/MWh _n] | | | | | | | | | |
|--|-------|-------|-------|-------|-------|-------|-------|-------|-------|
| Plot ratio [-] | 2,0 | 0,422 | 0,376 | 0,331 | 0,285 | 0,239 | 0,194 | 0,148 | 0,103 |
| | 1,8 | 0,422 | 0,376 | 0,330 | 0,285 | 0,239 | 0,194 | 0,148 | 0,103 |
| | 1,6 | 0,421 | 0,376 | 0,330 | 0,285 | 0,239 | 0,194 | 0,148 | 0,103 |
| | 1,4 | 0,421 | 0,376 | 0,330 | 0,285 | 0,239 | 0,194 | 0,148 | 0,103 |
| | 1,2 | 0,421 | 0,376 | 0,330 | 0,285 | 0,239 | 0,194 | 0,148 | 0,102 |
| | 1,0 | 0,421 | 0,376 | 0,330 | 0,285 | 0,239 | 0,193 | 0,148 | 0,102 |
| | 0,8 | 0,421 | 0,376 | 0,330 | 0,284 | 0,239 | 0,193 | 0,148 | 0,102 |
| | 0,6 | 0,421 | 0,376 | 0,330 | 0,284 | 0,239 | 0,193 | 0,148 | 0,102 |
| | 0,4 | 0,421 | 0,375 | 0,330 | 0,284 | 0,239 | 0,193 | 0,147 | 0,102 |
| 0,2 | 0,421 | 0,376 | 0,330 | 0,284 | 0,238 | 0,193 | 0,147 | 0,101 | |
| | | 0,1 | 0,2 | 0,3 | 0,4 | 0,5 | 0,6 | 0,7 | 0,8 |
| Space heating share [-] | | | | | | | | | |

| | | Primary energy factor-ULTDH_Air_EH2HP [MWh/MWh _h] | | | | | | | |
|----------------|-----|---|-------|-------|-------|-------|-------|-------|-------|
| Plot ratio [-] | 2,0 | 0,462 | 0,441 | 0,420 | 0,399 | 0,377 | 0,356 | 0,335 | 0,313 |
| | 1,8 | 0,463 | 0,442 | 0,421 | 0,399 | 0,378 | 0,357 | 0,335 | 0,313 |
| | 1,6 | 0,464 | 0,443 | 0,422 | 0,400 | 0,379 | 0,357 | 0,335 | 0,313 |
| | 1,4 | 0,465 | 0,444 | 0,423 | 0,401 | 0,379 | 0,358 | 0,336 | 0,314 |
| | 1,2 | 0,467 | 0,445 | 0,424 | 0,402 | 0,381 | 0,359 | 0,337 | 0,314 |
| | 1,0 | 0,469 | 0,447 | 0,426 | 0,404 | 0,382 | 0,360 | 0,337 | 0,315 |
| | 0,8 | 0,472 | 0,450 | 0,428 | 0,406 | 0,384 | 0,361 | 0,339 | 0,316 |
| | 0,6 | 0,476 | 0,454 | 0,432 | 0,409 | 0,387 | 0,364 | 0,341 | 0,317 |
| | 0,4 | 0,484 | 0,461 | 0,438 | 0,415 | 0,391 | 0,368 | 0,344 | 0,320 |
| | 0,2 | 0,501 | 0,477 | 0,452 | 0,428 | 0,403 | 0,378 | 0,352 | 0,326 |
| | | 0,1 | 0,2 | 0,3 | 0,4 | 0,5 | 0,6 | 0,7 | 0,8 |
| | | Space heating share [-] | | | | | | | |

| | | Primary energy factor-ULTDH_Air_EH3HP [MWh/MWh _h] | | | | | | | |
|----------------|-----|---|-------|-------|-------|-------|-------|-------|-------|
| Plot ratio [-] | 2,0 | 0,469 | 0,452 | 0,435 | 0,417 | 0,400 | 0,382 | 0,365 | 0,347 |
| | 1,8 | 0,470 | 0,453 | 0,435 | 0,418 | 0,400 | 0,383 | 0,365 | 0,347 |
| | 1,6 | 0,471 | 0,454 | 0,436 | 0,419 | 0,401 | 0,384 | 0,366 | 0,347 |
| | 1,4 | 0,473 | 0,455 | 0,438 | 0,420 | 0,402 | 0,384 | 0,366 | 0,348 |
| | 1,2 | 0,474 | 0,457 | 0,439 | 0,421 | 0,403 | 0,385 | 0,367 | 0,348 |
| | 1,0 | 0,477 | 0,459 | 0,441 | 0,423 | 0,405 | 0,387 | 0,368 | 0,349 |
| | 0,8 | 0,480 | 0,462 | 0,444 | 0,426 | 0,407 | 0,389 | 0,370 | 0,350 |
| | 0,6 | 0,485 | 0,467 | 0,448 | 0,429 | 0,411 | 0,391 | 0,372 | 0,352 |
| | 0,4 | 0,494 | 0,475 | 0,455 | 0,436 | 0,416 | 0,396 | 0,376 | 0,355 |
| | 0,2 | 0,514 | 0,494 | 0,473 | 0,451 | 0,430 | 0,408 | 0,386 | 0,362 |
| | | 0,1 | 0,2 | 0,3 | 0,4 | 0,5 | 0,6 | 0,7 | 0,8 |
| | | Space heating share [-] | | | | | | | |

| | | Primary energy factor-ULTDH_Micro_ASHP [MWh/MWh _h] | | | | | | | |
|----------------|-----|--|-------|-------|-------|-------|-------|-------|-------|
| Plot ratio [-] | 2,0 | 0,394 | 0,406 | 0,420 | 0,435 | 0,450 | 0,464 | 0,479 | 0,493 |
| | 1,8 | 0,396 | 0,407 | 0,421 | 0,436 | 0,451 | 0,465 | 0,480 | 0,494 |
| | 1,6 | 0,397 | 0,408 | 0,422 | 0,437 | 0,452 | 0,466 | 0,480 | 0,494 |
| | 1,4 | 0,399 | 0,410 | 0,424 | 0,438 | 0,453 | 0,467 | 0,481 | 0,495 |
| | 1,2 | 0,402 | 0,412 | 0,426 | 0,440 | 0,454 | 0,468 | 0,482 | 0,495 |
| | 1,0 | 0,405 | 0,415 | 0,429 | 0,443 | 0,456 | 0,470 | 0,484 | 0,497 |
| | 0,8 | 0,409 | 0,419 | 0,432 | 0,446 | 0,459 | 0,473 | 0,486 | 0,498 |
| | 0,6 | 0,416 | 0,425 | 0,438 | 0,451 | 0,464 | 0,476 | 0,489 | 0,500 |
| | 0,4 | 0,428 | 0,435 | 0,447 | 0,459 | 0,471 | 0,483 | 0,494 | 0,504 |
| | 0,2 | 0,456 | 0,460 | 0,469 | 0,479 | 0,488 | 0,498 | 0,506 | 0,513 |
| | | 0,1 | 0,2 | 0,3 | 0,4 | 0,5 | 0,6 | 0,7 | 0,8 |
| | | Space heating share [-] | | | | | | | |

| | | Primary energy factor-ULTDH_Micro_GWHP [MWh/MWh _n] | | | | | | | |
|----------------|-----|--|-------|-------|-------|-------|-------|-------|-------|
| Plot ratio [-] | 2,0 | 0,337 | 0,334 | 0,334 | 0,334 | 0,335 | 0,335 | 0,335 | 0,335 |
| | 1,8 | 0,339 | 0,335 | 0,334 | 0,335 | 0,335 | 0,336 | 0,336 | 0,336 |
| | 1,6 | 0,340 | 0,336 | 0,336 | 0,336 | 0,336 | 0,336 | 0,336 | 0,336 |
| | 1,4 | 0,342 | 0,337 | 0,337 | 0,337 | 0,337 | 0,337 | 0,337 | 0,337 |
| | 1,2 | 0,344 | 0,339 | 0,339 | 0,338 | 0,338 | 0,338 | 0,338 | 0,337 |
| | 1,0 | 0,347 | 0,342 | 0,341 | 0,340 | 0,340 | 0,340 | 0,339 | 0,338 |
| | 0,8 | 0,351 | 0,345 | 0,344 | 0,343 | 0,343 | 0,342 | 0,341 | 0,339 |
| | 0,6 | 0,356 | 0,350 | 0,348 | 0,347 | 0,346 | 0,345 | 0,343 | 0,341 |
| | 0,4 | 0,367 | 0,359 | 0,356 | 0,354 | 0,352 | 0,350 | 0,348 | 0,344 |
| | 0,2 | 0,391 | 0,380 | 0,375 | 0,371 | 0,367 | 0,363 | 0,358 | 0,352 |
| | | 0,1 | 0,2 | 0,3 | 0,4 | 0,5 | 0,6 | 0,7 | 0,8 |
| | | Space heating share [-] | | | | | | | |

| | | Primary energy factor-ULTDH_Micro_EH1HEX [MWh/MWh _n] | | | | | | | |
|----------------|-----|--|-------|-------|-------|-------|-------|-------|-------|
| Plot ratio [-] | 2,0 | 0,041 | 0,032 | 0,029 | 0,026 | 0,024 | 0,021 | 0,019 | 0,017 |
| | 1,8 | 0,041 | 0,032 | 0,029 | 0,026 | 0,024 | 0,021 | 0,019 | 0,017 |
| | 1,6 | 0,041 | 0,032 | 0,029 | 0,026 | 0,024 | 0,021 | 0,019 | 0,016 |
| | 1,4 | 0,041 | 0,032 | 0,029 | 0,026 | 0,024 | 0,021 | 0,019 | 0,016 |
| | 1,2 | 0,041 | 0,032 | 0,029 | 0,026 | 0,024 | 0,021 | 0,019 | 0,016 |
| | 1,0 | 0,041 | 0,032 | 0,029 | 0,026 | 0,023 | 0,021 | 0,018 | 0,016 |
| | 0,8 | 0,041 | 0,032 | 0,029 | 0,026 | 0,023 | 0,021 | 0,018 | 0,016 |
| | 0,6 | 0,042 | 0,032 | 0,028 | 0,026 | 0,023 | 0,021 | 0,018 | 0,016 |
| | 0,4 | 0,043 | 0,032 | 0,028 | 0,026 | 0,023 | 0,020 | 0,018 | 0,015 |
| | 0,2 | 0,045 | 0,033 | 0,028 | 0,026 | 0,023 | 0,020 | 0,018 | 0,015 |
| | | 0,1 | 0,2 | 0,3 | 0,4 | 0,5 | 0,6 | 0,7 | 0,8 |
| | | Space heating share [-] | | | | | | | |

| | | Primary energy factor-ULTDH_Micro_EH2HP [MWh/MWh _n] | | | | | | | |
|----------------|-----|---|-------|-------|-------|-------|-------|-------|-------|
| Plot ratio [-] | 2,0 | 0,275 | 0,270 | 0,270 | 0,270 | 0,270 | 0,270 | 0,270 | 0,270 |
| | 1,8 | 0,276 | 0,271 | 0,271 | 0,271 | 0,271 | 0,271 | 0,271 | 0,270 |
| | 1,6 | 0,277 | 0,272 | 0,272 | 0,271 | 0,271 | 0,271 | 0,271 | 0,270 |
| | 1,4 | 0,278 | 0,273 | 0,273 | 0,272 | 0,272 | 0,272 | 0,271 | 0,271 |
| | 1,2 | 0,280 | 0,275 | 0,274 | 0,274 | 0,273 | 0,273 | 0,272 | 0,271 |
| | 1,0 | 0,282 | 0,277 | 0,276 | 0,275 | 0,275 | 0,274 | 0,273 | 0,272 |
| | 0,8 | 0,286 | 0,279 | 0,278 | 0,277 | 0,276 | 0,275 | 0,274 | 0,273 |
| | 0,6 | 0,290 | 0,283 | 0,282 | 0,280 | 0,279 | 0,278 | 0,276 | 0,274 |
| | 0,4 | 0,298 | 0,290 | 0,288 | 0,286 | 0,284 | 0,282 | 0,280 | 0,277 |
| | 0,2 | 0,318 | 0,307 | 0,303 | 0,299 | 0,296 | 0,292 | 0,288 | 0,283 |
| | | 0,1 | 0,2 | 0,3 | 0,4 | 0,5 | 0,6 | 0,7 | 0,8 |
| | | Space heating share [-] | | | | | | | |

| Primary energy factor-ULTDH_Micro_EH3HP [MWh/MWh _h] | | | | | | | | |
|---|-------|-------|-------|-------|-------|-------|-------|-------|
| 2,0 | 0,315 | 0,310 | 0,310 | 0,311 | 0,311 | 0,311 | 0,311 | 0,311 |
| 1,8 | 0,316 | 0,311 | 0,311 | 0,311 | 0,312 | 0,312 | 0,312 | 0,311 |
| 1,6 | 0,317 | 0,312 | 0,312 | 0,312 | 0,312 | 0,312 | 0,312 | 0,312 |
| 1,4 | 0,319 | 0,314 | 0,313 | 0,313 | 0,313 | 0,313 | 0,313 | 0,312 |
| 1,2 | 0,321 | 0,316 | 0,315 | 0,315 | 0,314 | 0,314 | 0,314 | 0,313 |
| 1,0 | 0,323 | 0,318 | 0,317 | 0,316 | 0,316 | 0,315 | 0,315 | 0,314 |
| 0,8 | 0,327 | 0,321 | 0,320 | 0,319 | 0,318 | 0,317 | 0,316 | 0,315 |
| 0,6 | 0,332 | 0,326 | 0,324 | 0,323 | 0,322 | 0,320 | 0,319 | 0,316 |
| 0,4 | 0,342 | 0,334 | 0,331 | 0,329 | 0,327 | 0,325 | 0,323 | 0,319 |
| 0,2 | 0,364 | 0,353 | 0,348 | 0,345 | 0,341 | 0,337 | 0,332 | 0,327 |
| | 0,1 | 0,2 | 0,3 | 0,4 | 0,5 | 0,6 | 0,7 | 0,8 |

| Primary energy factor-ULTDH_Booster_ASHP [MWh/MWh _h] | | | | | | | | |
|--|-------|-------|-------|-------|-------|-------|-------|-------|
| 2,0 | 0,394 | 0,406 | 0,420 | 0,435 | 0,450 | 0,464 | 0,479 | 0,493 |
| 1,8 | 0,396 | 0,407 | 0,421 | 0,436 | 0,451 | 0,465 | 0,480 | 0,494 |
| 1,6 | 0,397 | 0,408 | 0,422 | 0,437 | 0,452 | 0,466 | 0,480 | 0,494 |
| 1,4 | 0,399 | 0,410 | 0,424 | 0,438 | 0,453 | 0,467 | 0,481 | 0,495 |
| 1,2 | 0,402 | 0,412 | 0,426 | 0,440 | 0,454 | 0,468 | 0,482 | 0,495 |
| 1,0 | 0,405 | 0,415 | 0,429 | 0,443 | 0,456 | 0,470 | 0,484 | 0,497 |
| 0,8 | 0,409 | 0,419 | 0,432 | 0,446 | 0,459 | 0,473 | 0,486 | 0,498 |
| 0,6 | 0,416 | 0,425 | 0,438 | 0,451 | 0,464 | 0,476 | 0,489 | 0,500 |
| 0,4 | 0,428 | 0,435 | 0,447 | 0,459 | 0,471 | 0,483 | 0,494 | 0,504 |
| 0,2 | 0,456 | 0,460 | 0,469 | 0,479 | 0,488 | 0,498 | 0,506 | 0,513 |
| | 0,1 | 0,2 | 0,3 | 0,4 | 0,5 | 0,6 | 0,7 | 0,8 |

| Primary energy factor-ULTDH_Booster_GWHP [MWh/MWh _h] | | | | | | | | |
|--|-------|-------|-------|-------|-------|-------|-------|-------|
| 2,0 | 0,337 | 0,334 | 0,334 | 0,334 | 0,335 | 0,335 | 0,335 | 0,335 |
| 1,8 | 0,339 | 0,335 | 0,334 | 0,335 | 0,335 | 0,336 | 0,336 | 0,336 |
| 1,6 | 0,340 | 0,336 | 0,336 | 0,336 | 0,336 | 0,336 | 0,336 | 0,336 |
| 1,4 | 0,342 | 0,337 | 0,337 | 0,337 | 0,337 | 0,337 | 0,337 | 0,337 |
| 1,2 | 0,344 | 0,339 | 0,339 | 0,338 | 0,338 | 0,338 | 0,338 | 0,337 |
| 1,0 | 0,347 | 0,342 | 0,341 | 0,340 | 0,340 | 0,340 | 0,339 | 0,338 |
| 0,8 | 0,351 | 0,345 | 0,344 | 0,343 | 0,343 | 0,342 | 0,341 | 0,339 |
| 0,6 | 0,356 | 0,350 | 0,348 | 0,347 | 0,346 | 0,345 | 0,343 | 0,341 |
| 0,4 | 0,367 | 0,359 | 0,356 | 0,354 | 0,352 | 0,350 | 0,348 | 0,344 |
| 0,2 | 0,391 | 0,380 | 0,375 | 0,371 | 0,367 | 0,363 | 0,358 | 0,352 |
| | 0,1 | 0,2 | 0,3 | 0,4 | 0,5 | 0,6 | 0,7 | 0,8 |

| | | Primary energy factor-ULTDH_Booster_EH1HEX [MWh/MWh _h] | | | | | | | |
|----------------|-----|--|-------|-------|-------|-------|-------|-------|-------|
| Plot ratio [-] | 2,0 | 0,041 | 0,032 | 0,029 | 0,026 | 0,024 | 0,021 | 0,019 | 0,017 |
| | 1,8 | 0,041 | 0,032 | 0,029 | 0,026 | 0,024 | 0,021 | 0,019 | 0,017 |
| | 1,6 | 0,041 | 0,032 | 0,029 | 0,026 | 0,024 | 0,021 | 0,019 | 0,016 |
| | 1,4 | 0,041 | 0,032 | 0,029 | 0,026 | 0,024 | 0,021 | 0,019 | 0,016 |
| | 1,2 | 0,041 | 0,032 | 0,029 | 0,026 | 0,024 | 0,021 | 0,019 | 0,016 |
| | 1,0 | 0,041 | 0,032 | 0,029 | 0,026 | 0,023 | 0,021 | 0,018 | 0,016 |
| | 0,8 | 0,041 | 0,032 | 0,029 | 0,026 | 0,023 | 0,021 | 0,018 | 0,016 |
| | 0,6 | 0,042 | 0,032 | 0,028 | 0,026 | 0,023 | 0,021 | 0,018 | 0,016 |
| | 0,4 | 0,043 | 0,032 | 0,028 | 0,026 | 0,023 | 0,020 | 0,018 | 0,015 |
| | 0,2 | 0,045 | 0,033 | 0,028 | 0,026 | 0,023 | 0,020 | 0,018 | 0,015 |
| | | 0,1 | 0,2 | 0,3 | 0,4 | 0,5 | 0,6 | 0,7 | 0,8 |
| | | Space heating share [-] | | | | | | | |

| | | Primary energy factor-ULTDH_Booster_EH2HP [MWh/MWh _h] | | | | | | | |
|----------------|-----|---|-------|-------|-------|-------|-------|-------|-------|
| Plot ratio [-] | 2,0 | 0,275 | 0,270 | 0,270 | 0,270 | 0,270 | 0,270 | 0,270 | 0,270 |
| | 1,8 | 0,276 | 0,271 | 0,271 | 0,271 | 0,271 | 0,271 | 0,271 | 0,270 |
| | 1,6 | 0,277 | 0,272 | 0,272 | 0,271 | 0,271 | 0,271 | 0,271 | 0,270 |
| | 1,4 | 0,278 | 0,273 | 0,273 | 0,272 | 0,272 | 0,272 | 0,271 | 0,271 |
| | 1,2 | 0,280 | 0,275 | 0,274 | 0,274 | 0,273 | 0,273 | 0,272 | 0,271 |
| | 1,0 | 0,282 | 0,277 | 0,276 | 0,275 | 0,275 | 0,274 | 0,273 | 0,272 |
| | 0,8 | 0,286 | 0,279 | 0,278 | 0,277 | 0,276 | 0,275 | 0,274 | 0,273 |
| | 0,6 | 0,290 | 0,283 | 0,282 | 0,280 | 0,279 | 0,278 | 0,276 | 0,274 |
| | 0,4 | 0,298 | 0,290 | 0,288 | 0,286 | 0,284 | 0,282 | 0,280 | 0,277 |
| | 0,2 | 0,318 | 0,307 | 0,303 | 0,299 | 0,296 | 0,292 | 0,288 | 0,283 |
| | | 0,1 | 0,2 | 0,3 | 0,4 | 0,5 | 0,6 | 0,7 | 0,8 |
| | | Space heating share [-] | | | | | | | |

| | | Primary energy factor-ULTDH_Booster_EH3HP [MWh/MWh _h] | | | | | | | |
|----------------|-----|---|-------|-------|-------|-------|-------|-------|-------|
| Plot ratio [-] | 2,0 | 0,315 | 0,310 | 0,310 | 0,311 | 0,311 | 0,311 | 0,311 | 0,311 |
| | 1,8 | 0,316 | 0,311 | 0,311 | 0,311 | 0,312 | 0,312 | 0,312 | 0,311 |
| | 1,6 | 0,317 | 0,312 | 0,312 | 0,312 | 0,312 | 0,312 | 0,312 | 0,312 |
| | 1,4 | 0,319 | 0,314 | 0,313 | 0,313 | 0,313 | 0,313 | 0,313 | 0,312 |
| | 1,2 | 0,321 | 0,316 | 0,315 | 0,315 | 0,314 | 0,314 | 0,314 | 0,313 |
| | 1,0 | 0,323 | 0,318 | 0,317 | 0,316 | 0,316 | 0,315 | 0,315 | 0,314 |
| | 0,8 | 0,327 | 0,321 | 0,320 | 0,319 | 0,318 | 0,317 | 0,316 | 0,315 |
| | 0,6 | 0,332 | 0,326 | 0,324 | 0,323 | 0,322 | 0,320 | 0,319 | 0,316 |
| | 0,4 | 0,342 | 0,334 | 0,331 | 0,329 | 0,327 | 0,325 | 0,323 | 0,319 |
| | 0,2 | 0,364 | 0,353 | 0,348 | 0,345 | 0,341 | 0,337 | 0,332 | 0,327 |
| | | 0,1 | 0,2 | 0,3 | 0,4 | 0,5 | 0,6 | 0,7 | 0,8 |
| | | Space heating share [-] | | | | | | | |

| | | Primary energy factor-LTDH_ASHP [MWh/MWh _h] | | | | | | | |
|----------------|-----|---|-------|-------|-------|-------|-------|-------|-------|
| Plot ratio [-] | 2,0 | 0,559 | 0,568 | 0,581 | 0,596 | 0,610 | 0,624 | 0,637 | 0,650 |
| | 1,8 | 0,562 | 0,570 | 0,584 | 0,598 | 0,612 | 0,625 | 0,639 | 0,651 |
| | 1,6 | 0,565 | 0,573 | 0,587 | 0,600 | 0,614 | 0,627 | 0,640 | 0,653 |
| | 1,4 | 0,570 | 0,577 | 0,590 | 0,604 | 0,617 | 0,630 | 0,642 | 0,654 |
| | 1,2 | 0,575 | 0,582 | 0,594 | 0,607 | 0,620 | 0,633 | 0,645 | 0,656 |
| | 1,0 | 0,582 | 0,589 | 0,600 | 0,613 | 0,625 | 0,637 | 0,648 | 0,658 |
| | 0,8 | 0,592 | 0,597 | 0,608 | 0,620 | 0,631 | 0,642 | 0,653 | 0,662 |
| | 0,6 | 0,607 | 0,610 | 0,620 | 0,630 | 0,641 | 0,650 | 0,659 | 0,667 |
| | 0,4 | 0,632 | 0,632 | 0,640 | 0,648 | 0,657 | 0,664 | 0,671 | 0,676 |
| | 0,2 | 0,691 | 0,685 | 0,687 | 0,691 | 0,694 | 0,696 | 0,697 | 0,696 |
| | | 0,1 | 0,2 | 0,3 | 0,4 | 0,5 | 0,6 | 0,7 | 0,8 |
| | | Space heating share [-] | | | | | | | |

| | | Primary energy factor-LTDH_GWHP [MWh/MWh _h] | | | | | | | |
|----------------|-----|---|-------|-------|-------|-------|-------|-------|-------|
| Plot ratio [-] | 2,0 | 0,465 | 0,455 | 0,452 | 0,449 | 0,447 | 0,445 | 0,442 | 0,438 |
| | 1,8 | 0,468 | 0,457 | 0,454 | 0,451 | 0,449 | 0,446 | 0,443 | 0,439 |
| | 1,6 | 0,471 | 0,460 | 0,456 | 0,453 | 0,451 | 0,448 | 0,444 | 0,440 |
| | 1,4 | 0,475 | 0,463 | 0,459 | 0,456 | 0,453 | 0,450 | 0,446 | 0,442 |
| | 1,2 | 0,479 | 0,467 | 0,463 | 0,459 | 0,456 | 0,452 | 0,448 | 0,443 |
| | 1,0 | 0,485 | 0,473 | 0,467 | 0,464 | 0,460 | 0,455 | 0,451 | 0,445 |
| | 0,8 | 0,494 | 0,480 | 0,474 | 0,469 | 0,465 | 0,460 | 0,454 | 0,448 |
| | 0,6 | 0,506 | 0,491 | 0,484 | 0,478 | 0,473 | 0,466 | 0,460 | 0,452 |
| | 0,4 | 0,528 | 0,509 | 0,500 | 0,493 | 0,486 | 0,478 | 0,469 | 0,459 |
| | 0,2 | 0,579 | 0,553 | 0,539 | 0,528 | 0,517 | 0,505 | 0,491 | 0,476 |
| | | 0,1 | 0,2 | 0,3 | 0,4 | 0,5 | 0,6 | 0,7 | 0,8 |
| | | Space heating share [-] | | | | | | | |

| | | Primary energy factor-LTDH_EH1HP [MWh/MWh _h] | | | | | | | |
|----------------|-----|--|-------|-------|-------|-------|-------|-------|-------|
| Plot ratio [-] | 2,0 | 0,349 | 0,339 | 0,336 | 0,334 | 0,333 | 0,331 | 0,329 | 0,327 |
| | 1,8 | 0,351 | 0,341 | 0,338 | 0,336 | 0,334 | 0,332 | 0,330 | 0,327 |
| | 1,6 | 0,353 | 0,343 | 0,339 | 0,337 | 0,335 | 0,333 | 0,331 | 0,328 |
| | 1,4 | 0,356 | 0,345 | 0,341 | 0,339 | 0,337 | 0,335 | 0,332 | 0,329 |
| | 1,2 | 0,360 | 0,348 | 0,344 | 0,342 | 0,339 | 0,337 | 0,334 | 0,330 |
| | 1,0 | 0,365 | 0,352 | 0,348 | 0,345 | 0,342 | 0,339 | 0,336 | 0,332 |
| | 0,8 | 0,371 | 0,358 | 0,352 | 0,349 | 0,346 | 0,342 | 0,338 | 0,334 |
| | 0,6 | 0,381 | 0,366 | 0,360 | 0,356 | 0,352 | 0,347 | 0,342 | 0,337 |
| | 0,4 | 0,397 | 0,380 | 0,372 | 0,367 | 0,361 | 0,356 | 0,349 | 0,342 |
| | 0,2 | 0,437 | 0,413 | 0,401 | 0,393 | 0,384 | 0,375 | 0,366 | 0,355 |
| | | 0,1 | 0,2 | 0,3 | 0,4 | 0,5 | 0,6 | 0,7 | 0,8 |
| | | Space heating share [-] | | | | | | | |

| | | Primary energy factor-LTDH_EH2HP [MWh/MWh _h] | | | | | | | |
|----------------|-----|--|-------|-------|-------|-------|-------|-------|-------|
| Plot ratio [-] | 2,0 | 0,391 | 0,381 | 0,378 | 0,376 | 0,374 | 0,372 | 0,370 | 0,367 |
| | 1,8 | 0,393 | 0,383 | 0,380 | 0,377 | 0,375 | 0,373 | 0,371 | 0,368 |
| | 1,6 | 0,396 | 0,385 | 0,382 | 0,379 | 0,377 | 0,375 | 0,372 | 0,369 |
| | 1,4 | 0,399 | 0,388 | 0,384 | 0,381 | 0,379 | 0,376 | 0,373 | 0,370 |
| | 1,2 | 0,403 | 0,391 | 0,387 | 0,384 | 0,381 | 0,378 | 0,375 | 0,371 |
| | 1,0 | 0,408 | 0,396 | 0,391 | 0,388 | 0,384 | 0,381 | 0,377 | 0,373 |
| | 0,8 | 0,415 | 0,402 | 0,396 | 0,393 | 0,389 | 0,385 | 0,380 | 0,375 |
| | 0,6 | 0,426 | 0,411 | 0,405 | 0,400 | 0,395 | 0,390 | 0,385 | 0,378 |
| | 0,4 | 0,444 | 0,427 | 0,418 | 0,412 | 0,406 | 0,400 | 0,393 | 0,384 |
| | 0,2 | 0,488 | 0,463 | 0,451 | 0,442 | 0,432 | 0,422 | 0,411 | 0,398 |
| | | 0,1 | 0,2 | 0,3 | 0,4 | 0,5 | 0,6 | 0,7 | 0,8 |
| | | Space heating share [-] | | | | | | | |

| | | Primary energy factor-LTDH_EH3HP [MWh/MWh _h] | | | | | | | |
|----------------|-----|--|-------|-------|-------|-------|-------|-------|-------|
| Plot ratio [-] | 2,0 | 0,436 | 0,426 | 0,423 | 0,421 | 0,418 | 0,416 | 0,413 | 0,410 |
| | 1,8 | 0,439 | 0,428 | 0,425 | 0,422 | 0,420 | 0,417 | 0,414 | 0,411 |
| | 1,6 | 0,441 | 0,431 | 0,427 | 0,424 | 0,422 | 0,419 | 0,416 | 0,412 |
| | 1,4 | 0,445 | 0,434 | 0,430 | 0,427 | 0,424 | 0,421 | 0,417 | 0,413 |
| | 1,2 | 0,449 | 0,438 | 0,433 | 0,430 | 0,427 | 0,423 | 0,419 | 0,415 |
| | 1,0 | 0,455 | 0,442 | 0,437 | 0,434 | 0,430 | 0,426 | 0,422 | 0,417 |
| | 0,8 | 0,463 | 0,449 | 0,443 | 0,439 | 0,435 | 0,430 | 0,425 | 0,419 |
| | 0,6 | 0,475 | 0,459 | 0,453 | 0,447 | 0,442 | 0,436 | 0,430 | 0,423 |
| | 0,4 | 0,495 | 0,477 | 0,468 | 0,461 | 0,455 | 0,447 | 0,439 | 0,430 |
| | 0,2 | 0,543 | 0,518 | 0,505 | 0,494 | 0,484 | 0,472 | 0,460 | 0,446 |
| | | 0,1 | 0,2 | 0,3 | 0,4 | 0,5 | 0,6 | 0,7 | 0,8 |
| | | Space heating share [-] | | | | | | | |

| | | Primary energy factor-Individual_ASHP [MWh/MWh _h] | | | | | | | |
|----------------|-----|---|-------|-------|-------|-------|-------|-------|-------|
| Plot ratio [-] | 2,0 | 0,475 | 0,492 | 0,508 | 0,524 | 0,540 | 0,556 | 0,572 | 0,588 |
| | 1,8 | 0,475 | 0,492 | 0,508 | 0,524 | 0,540 | 0,556 | 0,572 | 0,588 |
| | 1,6 | 0,475 | 0,492 | 0,508 | 0,524 | 0,540 | 0,556 | 0,572 | 0,588 |
| | 1,4 | 0,475 | 0,492 | 0,508 | 0,524 | 0,540 | 0,556 | 0,572 | 0,588 |
| | 1,2 | 0,475 | 0,492 | 0,508 | 0,524 | 0,540 | 0,556 | 0,572 | 0,588 |
| | 1,0 | 0,475 | 0,492 | 0,508 | 0,524 | 0,540 | 0,556 | 0,572 | 0,588 |
| | 0,8 | 0,475 | 0,492 | 0,508 | 0,524 | 0,540 | 0,556 | 0,572 | 0,588 |
| | 0,6 | 0,475 | 0,492 | 0,508 | 0,524 | 0,540 | 0,556 | 0,572 | 0,588 |
| | 0,4 | 0,475 | 0,492 | 0,508 | 0,524 | 0,540 | 0,556 | 0,572 | 0,588 |
| | 0,2 | 0,475 | 0,492 | 0,508 | 0,524 | 0,540 | 0,556 | 0,572 | 0,588 |
| | | 0,1 | 0,2 | 0,3 | 0,4 | 0,5 | 0,6 | 0,7 | 0,8 |
| | | Space heating share [-] | | | | | | | |

The Lowest Primary energy factor [MWh/MWh_h]

| | | | | | | | | | |
|----------------|-----|-------|-------|-------|-------|-------|-------|-------|-------|
| Plot ratio [-] | 2,0 | 0,041 | 0,032 | 0,029 | 0,026 | 0,024 | 0,021 | 0,019 | 0,017 |
| | 1,8 | 0,041 | 0,032 | 0,029 | 0,026 | 0,024 | 0,021 | 0,019 | 0,017 |
| | 1,6 | 0,041 | 0,032 | 0,029 | 0,026 | 0,024 | 0,021 | 0,019 | 0,016 |
| | 1,4 | 0,041 | 0,032 | 0,029 | 0,026 | 0,024 | 0,021 | 0,019 | 0,016 |
| | 1,2 | 0,041 | 0,032 | 0,029 | 0,026 | 0,024 | 0,021 | 0,019 | 0,016 |
| | 1,0 | 0,041 | 0,032 | 0,029 | 0,026 | 0,023 | 0,021 | 0,018 | 0,016 |
| | 0,8 | 0,041 | 0,032 | 0,029 | 0,026 | 0,023 | 0,021 | 0,018 | 0,016 |
| | 0,6 | 0,042 | 0,032 | 0,028 | 0,026 | 0,023 | 0,021 | 0,018 | 0,016 |
| | 0,4 | 0,043 | 0,032 | 0,028 | 0,026 | 0,023 | 0,020 | 0,018 | 0,015 |
| | 0,2 | 0,045 | 0,033 | 0,028 | 0,026 | 0,023 | 0,020 | 0,018 | 0,015 |
| | | 0,1 | 0,2 | 0,3 | 0,4 | 0,5 | 0,6 | 0,7 | 0,8 |

Space heating share [-]

The Lowest Primary energy factor without the EH1 [MWh/MWh_h]

| | | | | | | | | | |
|----------------|-----|-------|-------|-------|-------|-------|-------|-------|-------|
| Plot ratio [-] | 2,0 | 0,275 | 0,270 | 0,270 | 0,270 | 0,270 | 0,270 | 0,270 | 0,270 |
| | 1,8 | 0,276 | 0,271 | 0,271 | 0,271 | 0,271 | 0,271 | 0,271 | 0,270 |
| | 1,6 | 0,277 | 0,272 | 0,272 | 0,271 | 0,271 | 0,271 | 0,271 | 0,270 |
| | 1,4 | 0,278 | 0,273 | 0,273 | 0,272 | 0,272 | 0,272 | 0,271 | 0,271 |
| | 1,2 | 0,280 | 0,275 | 0,274 | 0,274 | 0,273 | 0,273 | 0,272 | 0,271 |
| | 1,0 | 0,282 | 0,277 | 0,276 | 0,275 | 0,275 | 0,274 | 0,273 | 0,272 |
| | 0,8 | 0,286 | 0,279 | 0,278 | 0,277 | 0,276 | 0,275 | 0,274 | 0,273 |
| | 0,6 | 0,290 | 0,283 | 0,282 | 0,280 | 0,279 | 0,278 | 0,276 | 0,274 |
| | 0,4 | 0,298 | 0,290 | 0,288 | 0,286 | 0,284 | 0,282 | 0,280 | 0,277 |
| | 0,2 | 0,318 | 0,307 | 0,303 | 0,299 | 0,296 | 0,292 | 0,288 | 0,283 |
| | | 0,1 | 0,2 | 0,3 | 0,4 | 0,5 | 0,6 | 0,7 | 0,8 |

Space heating share [-]

The Lowest Primary energy factor without the EH [MWh/MWh_h]

| | | | | | | | | | |
|----------------|-----|-------|-------|-------|-------|-------|-------|-------|-------|
| Plot ratio [-] | 2,0 | 0,337 | 0,334 | 0,334 | 0,334 | 0,335 | 0,335 | 0,335 | 0,335 |
| | 1,8 | 0,339 | 0,335 | 0,334 | 0,335 | 0,335 | 0,336 | 0,336 | 0,336 |
| | 1,6 | 0,340 | 0,336 | 0,336 | 0,336 | 0,336 | 0,336 | 0,336 | 0,336 |
| | 1,4 | 0,342 | 0,337 | 0,337 | 0,337 | 0,337 | 0,337 | 0,337 | 0,337 |
| | 1,2 | 0,344 | 0,339 | 0,339 | 0,338 | 0,338 | 0,338 | 0,338 | 0,337 |
| | 1,0 | 0,347 | 0,342 | 0,341 | 0,340 | 0,340 | 0,340 | 0,339 | 0,338 |
| | 0,8 | 0,351 | 0,345 | 0,344 | 0,343 | 0,343 | 0,342 | 0,341 | 0,339 |
| | 0,6 | 0,356 | 0,350 | 0,348 | 0,347 | 0,346 | 0,345 | 0,343 | 0,341 |
| | 0,4 | 0,367 | 0,359 | 0,356 | 0,354 | 0,352 | 0,350 | 0,348 | 0,344 |
| | 0,2 | 0,391 | 0,380 | 0,375 | 0,371 | 0,367 | 0,363 | 0,358 | 0,352 |
| | | 0,1 | 0,2 | 0,3 | 0,4 | 0,5 | 0,6 | 0,7 | 0,8 |

Space heating share [-]

| Plot ratio [-] | 0,1 | 0,2 | 0,3 | 0,4 | 0,5 | 0,6 | 0,7 | 0,8 |
|----------------|-------|-------|-------|-------|-------|-------|-------|-------|
| 2,0 | 0,072 | 0,072 | 0,073 | 0,073 | 0,074 | 0,074 | 0,075 | 0,075 |
| 1,8 | 0,072 | 0,073 | 0,073 | 0,074 | 0,074 | 0,074 | 0,075 | 0,075 |
| 1,6 | 0,072 | 0,073 | 0,073 | 0,074 | 0,074 | 0,075 | 0,075 | 0,075 |
| 1,4 | 0,073 | 0,073 | 0,074 | 0,074 | 0,074 | 0,075 | 0,075 | 0,075 |
| 1,2 | 0,073 | 0,073 | 0,074 | 0,074 | 0,075 | 0,075 | 0,075 | 0,075 |
| 1,0 | 0,073 | 0,074 | 0,074 | 0,075 | 0,075 | 0,075 | 0,075 | 0,076 |
| 0,8 | 0,074 | 0,074 | 0,075 | 0,075 | 0,075 | 0,076 | 0,076 | 0,076 |
| 0,6 | 0,075 | 0,075 | 0,076 | 0,076 | 0,076 | 0,076 | 0,076 | 0,076 |
| 0,4 | 0,077 | 0,077 | 0,077 | 0,077 | 0,077 | 0,077 | 0,077 | 0,077 |
| 0,2 | 0,080 | 0,080 | 0,080 | 0,080 | 0,080 | 0,079 | 0,079 | 0,078 |

| Plot ratio [-] | 0,1 | 0,2 | 0,3 | 0,4 | 0,5 | 0,6 | 0,7 | 0,8 |
|----------------|-------|-------|-------|-------|-------|-------|-------|-------|
| 2,0 | 0,069 | 0,067 | 0,064 | 0,062 | 0,060 | 0,058 | 0,056 | 0,053 |
| 1,8 | 0,069 | 0,067 | 0,065 | 0,062 | 0,060 | 0,058 | 0,056 | 0,053 |
| 1,6 | 0,069 | 0,067 | 0,065 | 0,063 | 0,060 | 0,058 | 0,056 | 0,053 |
| 1,4 | 0,069 | 0,067 | 0,065 | 0,063 | 0,060 | 0,058 | 0,056 | 0,054 |
| 1,2 | 0,070 | 0,067 | 0,065 | 0,063 | 0,061 | 0,058 | 0,056 | 0,054 |
| 1,0 | 0,070 | 0,068 | 0,066 | 0,063 | 0,061 | 0,059 | 0,056 | 0,054 |
| 0,8 | 0,071 | 0,068 | 0,066 | 0,064 | 0,061 | 0,059 | 0,056 | 0,054 |
| 0,6 | 0,071 | 0,069 | 0,067 | 0,064 | 0,062 | 0,059 | 0,057 | 0,054 |
| 0,4 | 0,073 | 0,070 | 0,068 | 0,065 | 0,063 | 0,060 | 0,057 | 0,055 |
| 0,2 | 0,076 | 0,073 | 0,070 | 0,068 | 0,065 | 0,062 | 0,059 | 0,056 |

| Plot ratio [-] | 0,1 | 0,2 | 0,3 | 0,4 | 0,5 | 0,6 | 0,7 | 0,8 |
|----------------|-------|-------|-------|-------|-------|-------|-------|-------|
| 2,0 | 0,061 | 0,055 | 0,048 | 0,041 | 0,035 | 0,028 | 0,022 | 0,015 |
| 1,8 | 0,061 | 0,055 | 0,048 | 0,041 | 0,035 | 0,028 | 0,022 | 0,015 |
| 1,6 | 0,061 | 0,055 | 0,048 | 0,041 | 0,035 | 0,028 | 0,022 | 0,015 |
| 1,4 | 0,061 | 0,055 | 0,048 | 0,041 | 0,035 | 0,028 | 0,022 | 0,015 |
| 1,2 | 0,061 | 0,055 | 0,048 | 0,041 | 0,035 | 0,028 | 0,022 | 0,015 |
| 1,0 | 0,061 | 0,055 | 0,048 | 0,041 | 0,035 | 0,028 | 0,022 | 0,015 |
| 0,8 | 0,061 | 0,055 | 0,048 | 0,041 | 0,035 | 0,028 | 0,021 | 0,015 |
| 0,6 | 0,061 | 0,055 | 0,048 | 0,041 | 0,035 | 0,028 | 0,021 | 0,015 |
| 0,4 | 0,061 | 0,055 | 0,048 | 0,041 | 0,035 | 0,028 | 0,021 | 0,015 |
| 0,2 | 0,061 | 0,055 | 0,048 | 0,041 | 0,035 | 0,028 | 0,021 | 0,015 |

| | | CO ₂ factor-ULTDH_Air_EH2HP [tCO ₂ /MWh _h] | | | | | | | |
|----------------|-----|--|-------|-------|-------|-------|-------|-------|-------|
| Plot ratio [-] | 2,0 | 0,067 | 0,064 | 0,061 | 0,058 | 0,055 | 0,052 | 0,049 | 0,046 |
| | 1,8 | 0,067 | 0,064 | 0,061 | 0,058 | 0,055 | 0,052 | 0,049 | 0,046 |
| | 1,6 | 0,068 | 0,064 | 0,061 | 0,058 | 0,055 | 0,052 | 0,049 | 0,046 |
| | 1,4 | 0,068 | 0,065 | 0,061 | 0,058 | 0,055 | 0,052 | 0,049 | 0,046 |
| | 1,2 | 0,068 | 0,065 | 0,062 | 0,059 | 0,055 | 0,052 | 0,049 | 0,046 |
| | 1,0 | 0,068 | 0,065 | 0,062 | 0,059 | 0,056 | 0,052 | 0,049 | 0,046 |
| | 0,8 | 0,069 | 0,065 | 0,062 | 0,059 | 0,056 | 0,053 | 0,049 | 0,046 |
| | 0,6 | 0,069 | 0,066 | 0,063 | 0,060 | 0,056 | 0,053 | 0,050 | 0,046 |
| | 0,4 | 0,070 | 0,067 | 0,064 | 0,060 | 0,057 | 0,054 | 0,050 | 0,047 |
| | 0,2 | 0,073 | 0,069 | 0,066 | 0,062 | 0,059 | 0,055 | 0,051 | 0,047 |
| | | 0,1 | 0,2 | 0,3 | 0,4 | 0,5 | 0,6 | 0,7 | 0,8 |
| | | Space heating share [-] | | | | | | | |

| | | CO ₂ factor-ULTDH_Air_EH3HP [tCO ₂ /MWh _h] | | | | | | | |
|----------------|-----|--|-------|-------|-------|-------|-------|-------|-------|
| Plot ratio [-] | 2,0 | 0,068 | 0,066 | 0,063 | 0,061 | 0,058 | 0,056 | 0,053 | 0,050 |
| | 1,8 | 0,068 | 0,066 | 0,063 | 0,061 | 0,058 | 0,056 | 0,053 | 0,050 |
| | 1,6 | 0,069 | 0,066 | 0,063 | 0,061 | 0,058 | 0,056 | 0,053 | 0,051 |
| | 1,4 | 0,069 | 0,066 | 0,064 | 0,061 | 0,059 | 0,056 | 0,053 | 0,051 |
| | 1,2 | 0,069 | 0,066 | 0,064 | 0,061 | 0,059 | 0,056 | 0,053 | 0,051 |
| | 1,0 | 0,069 | 0,067 | 0,064 | 0,062 | 0,059 | 0,056 | 0,054 | 0,051 |
| | 0,8 | 0,070 | 0,067 | 0,065 | 0,062 | 0,059 | 0,057 | 0,054 | 0,051 |
| | 0,6 | 0,071 | 0,068 | 0,065 | 0,062 | 0,060 | 0,057 | 0,054 | 0,051 |
| | 0,4 | 0,072 | 0,069 | 0,066 | 0,063 | 0,061 | 0,058 | 0,055 | 0,052 |
| | 0,2 | 0,075 | 0,072 | 0,069 | 0,066 | 0,063 | 0,059 | 0,056 | 0,053 |
| | | 0,1 | 0,2 | 0,3 | 0,4 | 0,5 | 0,6 | 0,7 | 0,8 |
| | | Space heating share [-] | | | | | | | |

| | | CO ₂ factor-ULTDH_Micro_ASHP [tCO ₂ /MWh _h] | | | | | | | |
|----------------|-----|---|-------|-------|-------|-------|-------|-------|-------|
| Plot ratio [-] | 2,0 | 0,057 | 0,059 | 0,061 | 0,063 | 0,065 | 0,068 | 0,070 | 0,072 |
| | 1,8 | 0,058 | 0,059 | 0,061 | 0,063 | 0,066 | 0,068 | 0,070 | 0,072 |
| | 1,6 | 0,058 | 0,059 | 0,061 | 0,064 | 0,066 | 0,068 | 0,070 | 0,072 |
| | 1,4 | 0,058 | 0,060 | 0,062 | 0,064 | 0,066 | 0,068 | 0,070 | 0,072 |
| | 1,2 | 0,058 | 0,060 | 0,062 | 0,064 | 0,066 | 0,068 | 0,070 | 0,072 |
| | 1,0 | 0,059 | 0,060 | 0,062 | 0,064 | 0,066 | 0,068 | 0,070 | 0,072 |
| | 0,8 | 0,060 | 0,061 | 0,063 | 0,065 | 0,067 | 0,069 | 0,071 | 0,072 |
| | 0,6 | 0,061 | 0,062 | 0,064 | 0,066 | 0,067 | 0,069 | 0,071 | 0,073 |
| | 0,4 | 0,062 | 0,063 | 0,065 | 0,067 | 0,069 | 0,070 | 0,072 | 0,073 |
| | 0,2 | 0,066 | 0,067 | 0,068 | 0,070 | 0,071 | 0,072 | 0,074 | 0,075 |
| | | 0,1 | 0,2 | 0,3 | 0,4 | 0,5 | 0,6 | 0,7 | 0,8 |
| | | Space heating share [-] | | | | | | | |

| Plot ratio [-] | 0,1 | 0,2 | 0,3 | 0,4 | 0,5 | 0,6 | 0,7 | 0,8 |
|----------------|-------|-------|-------|-------|-------|-------|-------|-------|
| 2,0 | 0,049 | 0,049 | 0,049 | 0,049 | 0,049 | 0,049 | 0,049 | 0,049 |
| 1,8 | 0,049 | 0,049 | 0,049 | 0,049 | 0,049 | 0,049 | 0,049 | 0,049 |
| 1,6 | 0,049 | 0,049 | 0,049 | 0,049 | 0,049 | 0,049 | 0,049 | 0,049 |
| 1,4 | 0,050 | 0,049 | 0,049 | 0,049 | 0,049 | 0,049 | 0,049 | 0,049 |
| 1,2 | 0,050 | 0,049 | 0,049 | 0,049 | 0,049 | 0,049 | 0,049 | 0,049 |
| 1,0 | 0,050 | 0,050 | 0,050 | 0,050 | 0,049 | 0,049 | 0,049 | 0,049 |
| 0,8 | 0,051 | 0,050 | 0,050 | 0,050 | 0,050 | 0,050 | 0,050 | 0,049 |
| 0,6 | 0,052 | 0,051 | 0,051 | 0,051 | 0,050 | 0,050 | 0,050 | 0,050 |
| 0,4 | 0,053 | 0,052 | 0,052 | 0,052 | 0,051 | 0,051 | 0,051 | 0,050 |
| 0,2 | 0,057 | 0,055 | 0,055 | 0,054 | 0,053 | 0,053 | 0,052 | 0,051 |

| Plot ratio [-] | 0,1 | 0,2 | 0,3 | 0,4 | 0,5 | 0,6 | 0,7 | 0,8 |
|----------------|-------|-------|-------|-------|-------|-------|-------|-------|
| 2,0 | 0,006 | 0,005 | 0,004 | 0,004 | 0,003 | 0,003 | 0,003 | 0,002 |
| 1,8 | 0,006 | 0,005 | 0,004 | 0,004 | 0,003 | 0,003 | 0,003 | 0,002 |
| 1,6 | 0,006 | 0,005 | 0,004 | 0,004 | 0,003 | 0,003 | 0,003 | 0,002 |
| 1,4 | 0,006 | 0,005 | 0,004 | 0,004 | 0,003 | 0,003 | 0,003 | 0,002 |
| 1,2 | 0,006 | 0,005 | 0,004 | 0,004 | 0,003 | 0,003 | 0,003 | 0,002 |
| 1,0 | 0,006 | 0,005 | 0,004 | 0,004 | 0,003 | 0,003 | 0,003 | 0,002 |
| 0,8 | 0,006 | 0,005 | 0,004 | 0,004 | 0,003 | 0,003 | 0,003 | 0,002 |
| 0,6 | 0,006 | 0,005 | 0,004 | 0,004 | 0,003 | 0,003 | 0,003 | 0,002 |
| 0,4 | 0,006 | 0,005 | 0,004 | 0,004 | 0,003 | 0,003 | 0,003 | 0,002 |
| 0,2 | 0,007 | 0,005 | 0,004 | 0,004 | 0,003 | 0,003 | 0,003 | 0,002 |

| Plot ratio [-] | 0,1 | 0,2 | 0,3 | 0,4 | 0,5 | 0,6 | 0,7 | 0,8 |
|----------------|-------|-------|-------|-------|-------|-------|-------|-------|
| 2,0 | 0,040 | 0,039 | 0,039 | 0,039 | 0,039 | 0,039 | 0,039 | 0,039 |
| 1,8 | 0,040 | 0,039 | 0,039 | 0,039 | 0,039 | 0,039 | 0,039 | 0,039 |
| 1,6 | 0,040 | 0,040 | 0,040 | 0,039 | 0,039 | 0,039 | 0,039 | 0,039 |
| 1,4 | 0,041 | 0,040 | 0,040 | 0,040 | 0,040 | 0,040 | 0,039 | 0,039 |
| 1,2 | 0,041 | 0,040 | 0,040 | 0,040 | 0,040 | 0,040 | 0,040 | 0,039 |
| 1,0 | 0,041 | 0,040 | 0,040 | 0,040 | 0,040 | 0,040 | 0,040 | 0,040 |
| 0,8 | 0,042 | 0,041 | 0,040 | 0,040 | 0,040 | 0,040 | 0,040 | 0,040 |
| 0,6 | 0,042 | 0,041 | 0,041 | 0,041 | 0,041 | 0,040 | 0,040 | 0,040 |
| 0,4 | 0,043 | 0,042 | 0,042 | 0,042 | 0,041 | 0,041 | 0,041 | 0,040 |
| 0,2 | 0,046 | 0,045 | 0,044 | 0,044 | 0,043 | 0,042 | 0,042 | 0,041 |

| Plot ratio [-] | 0,1 | 0,2 | 0,3 | 0,4 | 0,5 | 0,6 | 0,7 | 0,8 |
|----------------|-------|-------|-------|-------|-------|-------|-------|-------|
| 2,0 | 0,046 | 0,045 | 0,045 | 0,045 | 0,045 | 0,045 | 0,045 | 0,045 |
| 1,8 | 0,046 | 0,045 | 0,045 | 0,045 | 0,045 | 0,045 | 0,045 | 0,045 |
| 1,6 | 0,046 | 0,045 | 0,045 | 0,045 | 0,045 | 0,045 | 0,045 | 0,045 |
| 1,4 | 0,046 | 0,046 | 0,046 | 0,046 | 0,046 | 0,046 | 0,046 | 0,045 |
| 1,2 | 0,047 | 0,046 | 0,046 | 0,046 | 0,046 | 0,046 | 0,046 | 0,046 |
| 1,0 | 0,047 | 0,046 | 0,046 | 0,046 | 0,046 | 0,046 | 0,046 | 0,046 |
| 0,8 | 0,048 | 0,047 | 0,046 | 0,046 | 0,046 | 0,046 | 0,046 | 0,046 |
| 0,6 | 0,048 | 0,047 | 0,047 | 0,047 | 0,047 | 0,047 | 0,046 | 0,046 |
| 0,4 | 0,050 | 0,049 | 0,048 | 0,048 | 0,048 | 0,047 | 0,047 | 0,046 |
| 0,2 | 0,053 | 0,051 | 0,051 | 0,050 | 0,050 | 0,049 | 0,048 | 0,048 |

| Plot ratio [-] | 0,1 | 0,2 | 0,3 | 0,4 | 0,5 | 0,6 | 0,7 | 0,8 |
|----------------|-------|-------|-------|-------|-------|-------|-------|-------|
| 2,0 | 0,057 | 0,059 | 0,061 | 0,063 | 0,065 | 0,068 | 0,070 | 0,072 |
| 1,8 | 0,058 | 0,059 | 0,061 | 0,063 | 0,066 | 0,068 | 0,070 | 0,072 |
| 1,6 | 0,058 | 0,059 | 0,061 | 0,064 | 0,066 | 0,068 | 0,070 | 0,072 |
| 1,4 | 0,058 | 0,060 | 0,062 | 0,064 | 0,066 | 0,068 | 0,070 | 0,072 |
| 1,2 | 0,058 | 0,060 | 0,062 | 0,064 | 0,066 | 0,068 | 0,070 | 0,072 |
| 1,0 | 0,059 | 0,060 | 0,062 | 0,064 | 0,066 | 0,068 | 0,070 | 0,072 |
| 0,8 | 0,060 | 0,061 | 0,063 | 0,065 | 0,067 | 0,069 | 0,071 | 0,072 |
| 0,6 | 0,061 | 0,062 | 0,064 | 0,066 | 0,067 | 0,069 | 0,071 | 0,073 |
| 0,4 | 0,062 | 0,063 | 0,065 | 0,067 | 0,069 | 0,070 | 0,072 | 0,073 |
| 0,2 | 0,066 | 0,067 | 0,068 | 0,070 | 0,071 | 0,072 | 0,074 | 0,075 |

| Plot ratio [-] | 0,1 | 0,2 | 0,3 | 0,4 | 0,5 | 0,6 | 0,7 | 0,8 |
|----------------|-------|-------|-------|-------|-------|-------|-------|-------|
| 2,0 | 0,049 | 0,049 | 0,049 | 0,049 | 0,049 | 0,049 | 0,049 | 0,049 |
| 1,8 | 0,049 | 0,049 | 0,049 | 0,049 | 0,049 | 0,049 | 0,049 | 0,049 |
| 1,6 | 0,049 | 0,049 | 0,049 | 0,049 | 0,049 | 0,049 | 0,049 | 0,049 |
| 1,4 | 0,050 | 0,049 | 0,049 | 0,049 | 0,049 | 0,049 | 0,049 | 0,049 |
| 1,2 | 0,050 | 0,049 | 0,049 | 0,049 | 0,049 | 0,049 | 0,049 | 0,049 |
| 1,0 | 0,050 | 0,050 | 0,050 | 0,050 | 0,049 | 0,049 | 0,049 | 0,049 |
| 0,8 | 0,051 | 0,050 | 0,050 | 0,050 | 0,050 | 0,050 | 0,050 | 0,049 |
| 0,6 | 0,052 | 0,051 | 0,051 | 0,051 | 0,050 | 0,050 | 0,050 | 0,050 |
| 0,4 | 0,053 | 0,052 | 0,052 | 0,052 | 0,051 | 0,051 | 0,051 | 0,050 |
| 0,2 | 0,057 | 0,055 | 0,055 | 0,054 | 0,053 | 0,053 | 0,052 | 0,051 |

| | | CO ₂ factor-ULTDH_Booster_EH1HEX [tCO ₂ /MWh _h] | | | | | | | |
|----------------|-----|---|-------|-------|-------|-------|-------|-------|-------|
| Plot ratio [-] | 2,0 | 0,006 | 0,005 | 0,004 | 0,004 | 0,003 | 0,003 | 0,003 | 0,002 |
| | 1,8 | 0,006 | 0,005 | 0,004 | 0,004 | 0,003 | 0,003 | 0,003 | 0,002 |
| | 1,6 | 0,006 | 0,005 | 0,004 | 0,004 | 0,003 | 0,003 | 0,003 | 0,002 |
| | 1,4 | 0,006 | 0,005 | 0,004 | 0,004 | 0,003 | 0,003 | 0,003 | 0,002 |
| | 1,2 | 0,006 | 0,005 | 0,004 | 0,004 | 0,003 | 0,003 | 0,003 | 0,002 |
| | 1,0 | 0,006 | 0,005 | 0,004 | 0,004 | 0,003 | 0,003 | 0,003 | 0,002 |
| | 0,8 | 0,006 | 0,005 | 0,004 | 0,004 | 0,003 | 0,003 | 0,003 | 0,002 |
| | 0,6 | 0,006 | 0,005 | 0,004 | 0,004 | 0,003 | 0,003 | 0,003 | 0,002 |
| | 0,4 | 0,006 | 0,005 | 0,004 | 0,004 | 0,003 | 0,003 | 0,003 | 0,002 |
| | 0,2 | 0,007 | 0,005 | 0,004 | 0,004 | 0,003 | 0,003 | 0,003 | 0,002 |
| | | 0,1 | 0,2 | 0,3 | 0,4 | 0,5 | 0,6 | 0,7 | 0,8 |
| | | Space heating share [-] | | | | | | | |

| | | CO ₂ factor-ULTDH_Booster_EH2HP [tCO ₂ /MWh _h] | | | | | | | |
|----------------|-----|--|-------|-------|-------|-------|-------|-------|-------|
| Plot ratio [-] | 2,0 | 0,040 | 0,039 | 0,039 | 0,039 | 0,039 | 0,039 | 0,039 | 0,039 |
| | 1,8 | 0,040 | 0,039 | 0,039 | 0,039 | 0,039 | 0,039 | 0,039 | 0,039 |
| | 1,6 | 0,040 | 0,040 | 0,040 | 0,039 | 0,039 | 0,039 | 0,039 | 0,039 |
| | 1,4 | 0,041 | 0,040 | 0,040 | 0,040 | 0,040 | 0,040 | 0,039 | 0,039 |
| | 1,2 | 0,041 | 0,040 | 0,040 | 0,040 | 0,040 | 0,040 | 0,040 | 0,039 |
| | 1,0 | 0,041 | 0,040 | 0,040 | 0,040 | 0,040 | 0,040 | 0,040 | 0,040 |
| | 0,8 | 0,042 | 0,041 | 0,040 | 0,040 | 0,040 | 0,040 | 0,040 | 0,040 |
| | 0,6 | 0,042 | 0,041 | 0,041 | 0,041 | 0,041 | 0,040 | 0,040 | 0,040 |
| | 0,4 | 0,043 | 0,042 | 0,042 | 0,042 | 0,041 | 0,041 | 0,041 | 0,040 |
| | 0,2 | 0,046 | 0,045 | 0,044 | 0,044 | 0,043 | 0,042 | 0,042 | 0,041 |
| | | 0,1 | 0,2 | 0,3 | 0,4 | 0,5 | 0,6 | 0,7 | 0,8 |
| | | Space heating share [-] | | | | | | | |

| | | CO ₂ factor-ULTDH_Booster_EH3HP [tCO ₂ /MWh _h] | | | | | | | |
|----------------|-----|--|-------|-------|-------|-------|-------|-------|-------|
| Plot ratio [-] | 2,0 | 0,046 | 0,045 | 0,045 | 0,045 | 0,045 | 0,045 | 0,045 | 0,045 |
| | 1,8 | 0,046 | 0,045 | 0,045 | 0,045 | 0,045 | 0,045 | 0,045 | 0,045 |
| | 1,6 | 0,046 | 0,045 | 0,045 | 0,045 | 0,045 | 0,045 | 0,045 | 0,045 |
| | 1,4 | 0,046 | 0,046 | 0,046 | 0,046 | 0,046 | 0,046 | 0,046 | 0,045 |
| | 1,2 | 0,047 | 0,046 | 0,046 | 0,046 | 0,046 | 0,046 | 0,046 | 0,046 |
| | 1,0 | 0,047 | 0,046 | 0,046 | 0,046 | 0,046 | 0,046 | 0,046 | 0,046 |
| | 0,8 | 0,048 | 0,047 | 0,046 | 0,046 | 0,046 | 0,046 | 0,046 | 0,046 |
| | 0,6 | 0,048 | 0,047 | 0,047 | 0,047 | 0,047 | 0,047 | 0,046 | 0,046 |
| | 0,4 | 0,050 | 0,049 | 0,048 | 0,048 | 0,048 | 0,047 | 0,047 | 0,046 |
| | 0,2 | 0,053 | 0,051 | 0,051 | 0,050 | 0,050 | 0,049 | 0,048 | 0,048 |
| | | 0,1 | 0,2 | 0,3 | 0,4 | 0,5 | 0,6 | 0,7 | 0,8 |
| | | Space heating share [-] | | | | | | | |

| | | CO ₂ factor-LTDH_ASHP [tCO ₂ /MWh _h] | | | | | | | |
|----------------|-----|--|-------|-------|-------|-------|-------|-------|-------|
| Plot ratio [-] | 2,0 | 0,081 | 0,083 | 0,085 | 0,087 | 0,089 | 0,091 | 0,093 | 0,095 |
| | 1,8 | 0,082 | 0,083 | 0,085 | 0,087 | 0,089 | 0,091 | 0,093 | 0,095 |
| | 1,6 | 0,082 | 0,083 | 0,085 | 0,087 | 0,089 | 0,091 | 0,093 | 0,095 |
| | 1,4 | 0,083 | 0,084 | 0,086 | 0,088 | 0,090 | 0,092 | 0,093 | 0,095 |
| | 1,2 | 0,084 | 0,085 | 0,086 | 0,088 | 0,090 | 0,092 | 0,094 | 0,095 |
| | 1,0 | 0,085 | 0,086 | 0,087 | 0,089 | 0,091 | 0,093 | 0,094 | 0,096 |
| | 0,8 | 0,086 | 0,087 | 0,088 | 0,090 | 0,092 | 0,093 | 0,095 | 0,096 |
| | 0,6 | 0,088 | 0,089 | 0,090 | 0,092 | 0,093 | 0,095 | 0,096 | 0,097 |
| | 0,4 | 0,092 | 0,092 | 0,093 | 0,094 | 0,096 | 0,097 | 0,098 | 0,098 |
| | 0,2 | 0,101 | 0,100 | 0,100 | 0,100 | 0,101 | 0,101 | 0,101 | 0,101 |
| | | 0,1 | 0,2 | 0,3 | 0,4 | 0,5 | 0,6 | 0,7 | 0,8 |
| | | Space heating share [-] | | | | | | | |

| | | CO ₂ factor-LTDH_GWHP [tCO ₂ /MWh _h] | | | | | | | |
|----------------|-----|--|-------|-------|-------|-------|-------|-------|-------|
| Plot ratio [-] | 2,0 | 0,068 | 0,066 | 0,066 | 0,065 | 0,065 | 0,065 | 0,064 | 0,064 |
| | 1,8 | 0,068 | 0,067 | 0,066 | 0,066 | 0,065 | 0,065 | 0,064 | 0,064 |
| | 1,6 | 0,068 | 0,067 | 0,066 | 0,066 | 0,066 | 0,065 | 0,065 | 0,064 |
| | 1,4 | 0,069 | 0,067 | 0,067 | 0,066 | 0,066 | 0,065 | 0,065 | 0,064 |
| | 1,2 | 0,070 | 0,068 | 0,067 | 0,067 | 0,066 | 0,066 | 0,065 | 0,064 |
| | 1,0 | 0,071 | 0,069 | 0,068 | 0,067 | 0,067 | 0,066 | 0,066 | 0,065 |
| | 0,8 | 0,072 | 0,070 | 0,069 | 0,068 | 0,068 | 0,067 | 0,066 | 0,065 |
| | 0,6 | 0,074 | 0,071 | 0,070 | 0,070 | 0,069 | 0,068 | 0,067 | 0,066 |
| | 0,4 | 0,077 | 0,074 | 0,073 | 0,072 | 0,071 | 0,070 | 0,068 | 0,067 |
| | 0,2 | 0,084 | 0,080 | 0,078 | 0,077 | 0,075 | 0,073 | 0,071 | 0,069 |
| | | 0,1 | 0,2 | 0,3 | 0,4 | 0,5 | 0,6 | 0,7 | 0,8 |
| | | Space heating share [-] | | | | | | | |

| | | CO ₂ factor-LTDH_EH1HP [tCO ₂ /MWh _h] | | | | | | | |
|----------------|-----|---|-------|-------|-------|-------|-------|-------|-------|
| Plot ratio [-] | 2,0 | 0,051 | 0,049 | 0,049 | 0,049 | 0,048 | 0,048 | 0,048 | 0,048 |
| | 1,8 | 0,051 | 0,050 | 0,049 | 0,049 | 0,049 | 0,048 | 0,048 | 0,048 |
| | 1,6 | 0,051 | 0,050 | 0,049 | 0,049 | 0,049 | 0,048 | 0,048 | 0,048 |
| | 1,4 | 0,052 | 0,050 | 0,050 | 0,049 | 0,049 | 0,049 | 0,048 | 0,048 |
| | 1,2 | 0,052 | 0,051 | 0,050 | 0,050 | 0,049 | 0,049 | 0,049 | 0,048 |
| | 1,0 | 0,053 | 0,051 | 0,051 | 0,050 | 0,050 | 0,049 | 0,049 | 0,048 |
| | 0,8 | 0,054 | 0,052 | 0,051 | 0,051 | 0,050 | 0,050 | 0,049 | 0,049 |
| | 0,6 | 0,055 | 0,053 | 0,052 | 0,052 | 0,051 | 0,051 | 0,050 | 0,049 |
| | 0,4 | 0,058 | 0,055 | 0,054 | 0,053 | 0,053 | 0,052 | 0,051 | 0,050 |
| | 0,2 | 0,064 | 0,060 | 0,058 | 0,057 | 0,056 | 0,055 | 0,053 | 0,052 |
| | | 0,1 | 0,2 | 0,3 | 0,4 | 0,5 | 0,6 | 0,7 | 0,8 |
| | | Space heating share [-] | | | | | | | |

| | | CO ₂ factor-LTDH_EH2HP [tCO ₂ /MWh _h] | | | | | | | |
|----------------|-----|---|-------|-------|-------|-------|-------|-------|-------|
| Plot ratio [-] | 2,0 | 0,057 | 0,055 | 0,055 | 0,055 | 0,054 | 0,054 | 0,054 | 0,053 |
| | 1,8 | 0,057 | 0,056 | 0,055 | 0,055 | 0,055 | 0,054 | 0,054 | 0,053 |
| | 1,6 | 0,058 | 0,056 | 0,056 | 0,055 | 0,055 | 0,054 | 0,054 | 0,054 |
| | 1,4 | 0,058 | 0,056 | 0,056 | 0,055 | 0,055 | 0,055 | 0,054 | 0,054 |
| | 1,2 | 0,059 | 0,057 | 0,056 | 0,056 | 0,055 | 0,055 | 0,055 | 0,054 |
| | 1,0 | 0,059 | 0,058 | 0,057 | 0,056 | 0,056 | 0,055 | 0,055 | 0,054 |
| | 0,8 | 0,060 | 0,058 | 0,058 | 0,057 | 0,057 | 0,056 | 0,055 | 0,055 |
| | 0,6 | 0,062 | 0,060 | 0,059 | 0,058 | 0,057 | 0,057 | 0,056 | 0,055 |
| | 0,4 | 0,065 | 0,062 | 0,061 | 0,060 | 0,059 | 0,058 | 0,057 | 0,056 |
| | 0,2 | 0,071 | 0,067 | 0,066 | 0,064 | 0,063 | 0,061 | 0,060 | 0,058 |
| | | 0,1 | 0,2 | 0,3 | 0,4 | 0,5 | 0,6 | 0,7 | 0,8 |
| | | Space heating share [-] | | | | | | | |

| | | CO ₂ factor-LTDH_EH3HP [tCO ₂ /MWh _h] | | | | | | | |
|----------------|-----|---|-------|-------|-------|-------|-------|-------|-------|
| Plot ratio [-] | 2,0 | 0,063 | 0,062 | 0,061 | 0,061 | 0,061 | 0,061 | 0,060 | 0,060 |
| | 1,8 | 0,064 | 0,062 | 0,062 | 0,061 | 0,061 | 0,061 | 0,060 | 0,060 |
| | 1,6 | 0,064 | 0,063 | 0,062 | 0,062 | 0,061 | 0,061 | 0,060 | 0,060 |
| | 1,4 | 0,065 | 0,063 | 0,062 | 0,062 | 0,062 | 0,061 | 0,061 | 0,060 |
| | 1,2 | 0,065 | 0,064 | 0,063 | 0,063 | 0,062 | 0,062 | 0,061 | 0,060 |
| | 1,0 | 0,066 | 0,064 | 0,064 | 0,063 | 0,063 | 0,062 | 0,061 | 0,061 |
| | 0,8 | 0,067 | 0,065 | 0,065 | 0,064 | 0,063 | 0,063 | 0,062 | 0,061 |
| | 0,6 | 0,069 | 0,067 | 0,066 | 0,065 | 0,064 | 0,063 | 0,063 | 0,062 |
| | 0,4 | 0,072 | 0,069 | 0,068 | 0,067 | 0,066 | 0,065 | 0,064 | 0,063 |
| | 0,2 | 0,079 | 0,075 | 0,073 | 0,072 | 0,070 | 0,069 | 0,067 | 0,065 |
| | | 0,1 | 0,2 | 0,3 | 0,4 | 0,5 | 0,6 | 0,7 | 0,8 |
| | | Space heating share [-] | | | | | | | |

| | | CO ₂ factor-Individual_ASHP [tCO ₂ /MWh _h] | | | | | | | |
|----------------|-----|--|-------|-------|-------|-------|-------|-------|-------|
| Plot ratio [-] | 2,0 | 0,069 | 0,072 | 0,074 | 0,076 | 0,079 | 0,081 | 0,083 | 0,086 |
| | 1,8 | 0,069 | 0,072 | 0,074 | 0,076 | 0,079 | 0,081 | 0,083 | 0,086 |
| | 1,6 | 0,069 | 0,072 | 0,074 | 0,076 | 0,079 | 0,081 | 0,083 | 0,086 |
| | 1,4 | 0,069 | 0,072 | 0,074 | 0,076 | 0,079 | 0,081 | 0,083 | 0,086 |
| | 1,2 | 0,069 | 0,072 | 0,074 | 0,076 | 0,079 | 0,081 | 0,083 | 0,086 |
| | 1,0 | 0,069 | 0,072 | 0,074 | 0,076 | 0,079 | 0,081 | 0,083 | 0,086 |
| | 0,8 | 0,069 | 0,072 | 0,074 | 0,076 | 0,079 | 0,081 | 0,083 | 0,086 |
| | 0,6 | 0,069 | 0,072 | 0,074 | 0,076 | 0,079 | 0,081 | 0,083 | 0,086 |
| | 0,4 | 0,069 | 0,072 | 0,074 | 0,076 | 0,079 | 0,081 | 0,083 | 0,086 |
| | 0,2 | 0,069 | 0,072 | 0,074 | 0,076 | 0,079 | 0,081 | 0,083 | 0,086 |
| | | 0,1 | 0,2 | 0,3 | 0,4 | 0,5 | 0,6 | 0,7 | 0,8 |
| | | Space heating share [-] | | | | | | | |

| | | The Lowest CO ₂ factor [tCO ₂ /MWh _n] | | | | | | | |
|----------------|-----|---|-------|-------|-------|-------|-------|-------|-------|
| Plot ratio [-] | 2,0 | 0,006 | 0,005 | 0,004 | 0,004 | 0,003 | 0,003 | 0,003 | 0,002 |
| | 1,8 | 0,006 | 0,005 | 0,004 | 0,004 | 0,003 | 0,003 | 0,003 | 0,002 |
| | 1,6 | 0,006 | 0,005 | 0,004 | 0,004 | 0,003 | 0,003 | 0,003 | 0,002 |
| | 1,4 | 0,006 | 0,005 | 0,004 | 0,004 | 0,003 | 0,003 | 0,003 | 0,002 |
| | 1,2 | 0,006 | 0,005 | 0,004 | 0,004 | 0,003 | 0,003 | 0,003 | 0,002 |
| | 1,0 | 0,006 | 0,005 | 0,004 | 0,004 | 0,003 | 0,003 | 0,003 | 0,002 |
| | 0,8 | 0,006 | 0,005 | 0,004 | 0,004 | 0,003 | 0,003 | 0,003 | 0,002 |
| | 0,6 | 0,006 | 0,005 | 0,004 | 0,004 | 0,003 | 0,003 | 0,003 | 0,002 |
| | 0,4 | 0,006 | 0,005 | 0,004 | 0,004 | 0,003 | 0,003 | 0,003 | 0,002 |
| | 0,2 | 0,007 | 0,005 | 0,004 | 0,004 | 0,003 | 0,003 | 0,003 | 0,002 |
| | | 0,1 | 0,2 | 0,3 | 0,4 | 0,5 | 0,6 | 0,7 | 0,8 |
| | | Space heating share [-] | | | | | | | |

| | | The Lowest CO ₂ factor without the EH1 [tCO ₂ /MWh _n] | | | | | | | |
|----------------|-----|---|-------|-------|-------|-------|-------|-------|-------|
| Plot ratio [-] | 2,0 | 0,040 | 0,039 | 0,039 | 0,039 | 0,039 | 0,039 | 0,039 | 0,039 |
| | 1,8 | 0,040 | 0,039 | 0,039 | 0,039 | 0,039 | 0,039 | 0,039 | 0,039 |
| | 1,6 | 0,040 | 0,040 | 0,040 | 0,039 | 0,039 | 0,039 | 0,039 | 0,039 |
| | 1,4 | 0,041 | 0,040 | 0,040 | 0,040 | 0,040 | 0,040 | 0,039 | 0,039 |
| | 1,2 | 0,041 | 0,040 | 0,040 | 0,040 | 0,040 | 0,040 | 0,040 | 0,039 |
| | 1,0 | 0,041 | 0,040 | 0,040 | 0,040 | 0,040 | 0,040 | 0,040 | 0,040 |
| | 0,8 | 0,042 | 0,041 | 0,040 | 0,040 | 0,040 | 0,040 | 0,040 | 0,040 |
| | 0,6 | 0,042 | 0,041 | 0,041 | 0,041 | 0,041 | 0,040 | 0,040 | 0,040 |
| | 0,4 | 0,043 | 0,042 | 0,042 | 0,042 | 0,041 | 0,041 | 0,041 | 0,040 |
| | 0,2 | 0,046 | 0,045 | 0,044 | 0,044 | 0,043 | 0,042 | 0,042 | 0,041 |
| | | 0,1 | 0,2 | 0,3 | 0,4 | 0,5 | 0,6 | 0,7 | 0,8 |
| | | Space heating share [-] | | | | | | | |

| | | The Lowest CO ₂ factor without the EH [tCO ₂ /MWh _n] | | | | | | | |
|----------------|-----|--|-------|-------|-------|-------|-------|-------|-------|
| Plot ratio [-] | 2,0 | 0,049 | 0,049 | 0,049 | 0,049 | 0,049 | 0,049 | 0,049 | 0,049 |
| | 1,8 | 0,049 | 0,049 | 0,049 | 0,049 | 0,049 | 0,049 | 0,049 | 0,049 |
| | 1,6 | 0,049 | 0,049 | 0,049 | 0,049 | 0,049 | 0,049 | 0,049 | 0,049 |
| | 1,4 | 0,050 | 0,049 | 0,049 | 0,049 | 0,049 | 0,049 | 0,049 | 0,049 |
| | 1,2 | 0,050 | 0,049 | 0,049 | 0,049 | 0,049 | 0,049 | 0,049 | 0,049 |
| | 1,0 | 0,050 | 0,050 | 0,050 | 0,050 | 0,049 | 0,049 | 0,049 | 0,049 |
| | 0,8 | 0,051 | 0,050 | 0,050 | 0,050 | 0,050 | 0,050 | 0,050 | 0,049 |
| | 0,6 | 0,052 | 0,051 | 0,051 | 0,051 | 0,050 | 0,050 | 0,050 | 0,050 |
| | 0,4 | 0,053 | 0,052 | 0,052 | 0,052 | 0,051 | 0,051 | 0,051 | 0,050 |
| | 0,2 | 0,057 | 0,055 | 0,055 | 0,054 | 0,053 | 0,053 | 0,052 | 0,051 |
| | | 0,1 | 0,2 | 0,3 | 0,4 | 0,5 | 0,6 | 0,7 | 0,8 |
| | | Space heating share [-] | | | | | | | |