

Control system evaluation within model based environment

Mastelić, Ante

Master's thesis / Diplomski rad

2020

Degree Grantor / Ustanova koja je dodijelila akademski / stručni stupanj: **University of Zagreb, Faculty of Mechanical Engineering and Naval Architecture / Sveučilište u Zagrebu, Fakultet strojarstva i brodogradnje**

Permanent link / Trajna poveznica: <https://urn.nsk.hr/urn:nbn:hr:235:528070>

Rights / Prava: [In copyright](#)/[Zaštićeno autorskim pravom.](#)

Download date / Datum preuzimanja: **2024-07-11**

Repository / Repozitorij:

[Repository of Faculty of Mechanical Engineering and Naval Architecture University of Zagreb](#)



UNIVERSITY OF ZAGREB
FACULTY OF MECHANICAL ENGINEERING AND NAVAL
ARCHITECTURE

MASTER'S THESIS

Ante Mastelić

Zagreb, July 2020

UNIVERSITY OF ZAGREB
FACULTY OF MECHANICAL ENGINEERING AND NAVAL
ARCHITECTURE

**CONTROL SYSTEM EVALUATION
WITHIN MODEL BASED
ENVIRONMENT**

Supervisors:

Prof. Dražen Lončar, PhD
Ante Marušić, PhD

Student:

Ante Mastelić

Zagreb, July 2020

I would like to express my sincere gratitude to my supervisor Prof. Dražen Lončar PhD on his great suggestions and remote guidance, as well as to Ante Marušić PhD for generous sharing of his knowledge and expertise.

I would like to thank to colleagues from Bosch Thermotechnology GmbH in Wernau, especially to my business supervisor M. Sc. David Kretschmann on exceptional and tireless support, as well as to the other colleagues from global offices, including Fabrizio Cola, Sneha Raghunandanan, Ching-Chih Lin and all other colleagues from the department.

Final thanks goes to my family and friends for unconditional support and understanding provided during academic life path.

I hereby declare that this thesis is entirely the result of my own work concept using tools of Bosch Thermotechnology GmbH. I have fully cited all used sources and I have only used the ones given in the list of references.



SVEUČILIŠTE U ZAGREBU

FAKULTET STROJARSTVA I BRODOGRADNJE

Središnje povjerenstvo za završne i diplomske ispite

Povjerenstvo za diplomske ispite studija strojarstva za smjerove:

procesno-energetski, konstrukcijski, brodstrojarski i inženjersko modeliranje i računalne simulacije



Sveučilište u Zagrebu	
Fakultet strojarstva i brodogradnje	
Datum:	Prilog:
Klasa: 602 - 04 / 20 - 6 / 3	
Ur. broj: 15 - 1703 - 20 -	

DIPLOMSKI ZADATAK

Student: **Ante Mastelić** Mat. br.: 0035197427

Naslov rada na engleskom jeziku: **Control system evaluation within model based environment**

Naslov rada na hrvatskom jeziku: **Ispitivanje regulacijskog sustava u modelskom okruženju**

Opis rada:

Hardware in the loop (HIL) concept employing real controller and true signal exchange with simulation platform is usually selected for control strategy evaluation in application where field testing is inconvenient, for example in energy systems of occupied buildings. Due to signal exchange with real controller HIL concept provides reliable control response.

Significance of efficient operation of building energy systems which usually accounts for more than 40 % of total energy use in most of developed countries, is increased recently, in line with energy efficiency and environmental policy goals.

The scope of the thesis will include:

1. An overview of the hardware in the loop concepts;
2. Formulation of mathematical model of thermohydraulic process dynamics in energy system of multi-zonal business building;
3. Open loop building simulation in typical days in summer and winter season;
4. Description of performed HIL tests of selected control system coupled with building energy system simulation platform;
5. Discussion of the results of performed control system tests.

It is necessary to reference used literature and received support, if any.

Zadatak zadan: Datum predaje rada: Predvideni datum obrane:
30. travnja 2020. 2. srpnja 2020. 6. – 10.7.2020.

Zadatak zadali: Predsjednica Povjerenstva:

Prof. dr. sc. Dražen Lončar

Prof. dr. sc. Tanja Jurčević Lulić

Dr. sc. Ante Marušić

Contents

List of figures.....	I
List of tables.....	III
Abbreviations and parameters.....	IV
Abstract.....	VII
Sažetak.....	VIII
Produženi sažetak.....	IX
1. Introduction.....	1
1.1. Motivation and thesis objective.....	2
1.2. Hardware-in-the-Loop overview.....	3
1.3. Central controller.....	6
1.4. V model.....	7
1.5. Model Based Development.....	9
1.6. Software testing.....	12
2. Simulation.....	14
2.1. Simulation library.....	14
2.1.1. Simulation library initialization blocks.....	15
2.2. Resistive-Capacitive (RC) Thermal Dynamics model.....	21
2.3. Applied RC model in the simulation.....	24
2.4. Heating/cooling principles.....	30
2.4.1. Refrigerants.....	35
2.4.2. Heat pumps.....	36
2.4.3. Basic models used in Simulation library.....	40
2.5. VRF system.....	42
2.5.1. Communication among VRF devices.....	47

3. Implementation	49
3.1. Comparison with the current state of the art	49
3.2. Reference system.....	50
3.3. Architecture of the new test bed.....	52
4. Results.....	54
4.1. Use cases	54
4.2. Test results for cooling.....	54
4.3. Test results for heating	63
4.4. Comparison of results.....	71
5. Conclusion	74
6. Bibliography	75

List of figures

Figure 1. Cost-of-change curve.....	2
Figure 2. General HiL scheme	3
Figure 3. Real HVAC system with control unit.....	4
Figure 4. Applied Hardware-in-the-Loop scheme	5
Figure 5. Central controller [2]	6
Figure 6. V-model software development	8
Figure 7. Cost of fixing bugs in different V-model areas of development [5]	9
Figure 8. MBD Adaption grid [6]	11
Figure 9. Scheme of simulation's temperature and energies interrelations.....	15
Figure 10. Simulation initialization values interconnection scheme	16
Figure 11. Real building inspiration [9].....	18
Figure 12. 3D model of a calculated building.....	18
Figure 13. 2D view of calculated building and numeration of the zones	20
Figure 14. Urban house RC model [11].....	21
Figure 15. RC model of 2 zones [10].....	24
Figure 16. RC building model scheme	25
Figure 17. Zero-dimensional model.....	28
Figure 18. Basic difference between refrigerator and heat pump [14]	31
Figure 19. Scheme and T-s diagram of ideal vapor-compression refrigeration cycle [14]	32
Figure 20. Heat transfer through pipe	33
Figure 21. Four-way valve [24]	37
Figure 22. Four-way valve in position for cooling [24].....	38
Figure 23. Four-way valve in position for heating [24].....	39
Figure 24. Simulation scheme of IDU	41
Figure 25. Commercial VRF scheme [25].....	43
Figure 26. VRF scheme with 3 IDUs and 1 ODU (cooling mode)	45
Figure 27. T-s diagram of cooling	46
Figure 28. VRF scheme with 3 IDUs and 1 ODU (heating mode).....	46
Figure 29. T-s diagram of heating.....	47
Figure 30. Parallel and serial communication interface [28].....	48
Figure 31. Selected zones of the building.....	50

Figure 32. Definition of wall, hull and ambient.....	52
Figure 33. Zone temperature in comparison to outdoor	55
Figure 34. Compressor frequency of ODUs	55
Figure 35. Refrigerant’s outlet temperatures	56
Figure 36. Distribution of cooling load.....	56
Figure 37. EEV openness (cooling).....	57
Figure 38. Temperature distribution of under dimensioned system	58
Figure 39. Cooling load of under dimensioned system	58
Figure 40. Temperature distribution	60
Figure 41. Cooling load	60
Figure 42. Compressor frequency of zone 1	61
Figure 43. Compressor frequency of zone 5	61
Figure 44. Compressor frequency of zone 7	62
Figure 45. Compressor frequency of zone 14	62
Figure 46. Zone temperature in comparison to outdoor	63
Figure 47. Compressor frequency of ODUs	64
Figure 48. Refrigerant’s outlet temperatures	64
Figure 49. Distribution of heating load.....	65
Figure 50. EEV openness (heating)	65
Figure 51. Temperature distribution of zone 1	67
Figure 52. Compressor frequency zone 1	67
Figure 53. Temperature distribution of zone 5	68
Figure 54. Compressor frequency zone 5	68
Figure 55. Temperature distribution of zone 7	69
Figure 56. Compressor frequency zone 7	69
Figure 57. Temperature distribution of zone 14	70
Figure 58. Compressor frequency zone 14	70
Figure 59. Different infiltration rates (cooling)	71
Figure 60. Different infiltration rates (heating)	71
Figure 61. Solar gains in Zone 1 and Zone 5	72
Figure 62. Zone 1 and 5 (solar gains)	72
Figure 63. RC building model without HVAC running system (cooling).....	73
Figure 64. RC building model without HVAC running system (heating).....	73

List of tables

Table 1. Physical properties of important building elements	19
Table 2. U-value for different layers of the wall	19
Table 3. Initial configuration of big VRF system (95 IDUs and 18 ODU).....	20
Table 4. RC variables per node.....	25
Table 5. Different properties of commonly used refrigerants [22].....	36
Table 6. Four-way valve components [24]	37
Table 7. VRF scheme explanation	43
Table 8. Example of incoming RC building parameters.....	50
Table 9. Better projected system (cooling)	59
Table 10. Reference system for heating.....	66

Abbreviations and parameters

Abbreviations

HiL	Hardware in the loop
MBD	Model based development
VRF	Variable refrigerant flow
IDU	Indoor unit
ODU	Outdoor unit
CC	Central controller
HVAC	Heating, cooling and air conditioning
RMSE	Root mean square error
GWP	Global warming potential
ODP	Ozone depletion potential
ODE	Ordinary differential equation
MDTD	Model-driven test design

Parameters

Symbol	Unit	Description
λ	W/m K	Heat conductivity
δ	m	Isolation thickness
c_p	J/kg K	Specific heat capacity
ρ	kg/m ³	Density
ε	-	Emissivity
U	W/m ² K	Heat transfer coefficient
Q	J or W	Heat
T	K or °C	Temperature
R	m ² K/W	Heat resistance
C	J/K	Heat capacity
$T_i^{[k]}(t)$	K	Temperature of the i -th element at time instant t within time-slot k
E_{in}	W	Energy flow
\dot{m}	kg/s	Mass flow
\dot{m}_{inf}	kg/s	Mass flow of infiltrated air
\dot{Q}_{occ}	W	Occupancy internal gains
\dot{Q}_{eq}	W	Internal gains of electronic equipment
\dot{Q}_{light}	W	Internal lightning gains
Q_L	J	Heat gains at lower temperature
T_L	°C	Lower temperature
Q_H	J	Heat gains at high temperature
W_{in}	J	Input net work for compressor
Φ	W	Heat flow
k	W/m ² K	Heat transfer coefficient
A	m ²	Surface
θ_{00a}	°C	Temperature of fluid “a”
θ_{00b}	°C	Temperature of fluid “b”
R	m	Radius of the tubes

L	M	Length of the tubes
α_a	W/m ² K	Convective heat transfer coefficient on side of fluid “a”
α_b	W/m ² K	Convective heat transfer coefficient on side of fluid “b”
θ_{s1}	°C	Wall temperature
Re	-	Reynolds number
Pr	-	Prandtl number
Nu	-	Nusselt number
Bo	-	Bond number
h_{liq}	W/m ² K	Heat transfer coefficient of a liquid
k_{liq}	W/m K	Thermal conductivity of a liquid
F	-	Ratio of steam qualities and densities
f	-	Flow type
d	m	Tube diameter
T_{air}	°C	Air temperature
T_{ref}	°C	Referent temperature
Δh	J/kg	Enthalpy change
G_{ref}	kg/m ² s	Mass flux
x	-	Steam quality
p_{ratio}	-	Ratio of critical and reference pressure

Abstract

Hardware in the Loop is the concept used for testing pieces of hardware against simulated signals in order to test it before installation in the real system. Using this concept, maximum number of signals that device can handle is being tested as a part of regular product development's testing phase.

In the simulation that represents the real system to hardware, custom building was created using Resistive-Capacitive Thermal Dynamics model, coupled with customizable HVAC system. This thesis aims to prove applicability of custom-made hardware in the loop paired with Simulink simulation, using the existing pieces of communication chain (server and clients) to test the limits of the central controller's software.

Keywords: *VRF, heat pumps, Simulink, Resistive Capacitive building model, Hardware in the Loop, testing, V model, evaluation of controller's regulation*

Sažetak

Hardver u petlji je koncept korišten za ispitivanje hardvera oponašajući signale s ciljem ispitivanja, prije primjene na stvarnom sustavu. Koristeći ovaj koncept, maksimalan broj signala se provjerava kao sastavni dio ispitne faze u području razvoja proizvoda.

U simulaciji, koja zamjenjuje realni/fizikalni sustav hardwareu, proizvoljna građevina je kreirana koristeći rezistivno kapacitivni termodinamički model, uparen s modularnim KGH sustavom. Diplomski rad pokušava dokazati primjenjivost prilagođenog “Hardware in the Loop” koncepta, spojenog na simulaciju, koristeći postojeći komunikacijski lanac (server i klijenti) za testiranje granica softwarea centralnog kontrolera.

Ključne riječi: *VRF, dizalice topline, Simulink, rezistivno kapacitivni model građevine, Hardver u petlji, testiranje, V model, evaluacija regulacije*

Prošireni sažetak

(Abstract in Croatian)

Porastom potrošnje energije u kućanstavima, energetska ušteda i što niži ugljični otisak postaju tržišni preduvjet zelenog razvoja.

Industrija sustava klimatizacije, grijanja i hlađenja (KGH) prati standarde temeljene na EU direktivama. Krajnji cilj je sofisticirana upotreba modernih softverskih rješenja, brzih načina izračuna potrošnje energije, individualizirana naplata potrošnje, automatizacije procesa i svođenjem regulatora na telefonsku aplikaciju, kojom se sustav može upravljati s udaljenosti. Uz sve spomenuto, industrija sustava KGH polako prihvaća spomenuta unaprijeđenja koja ima sve veću primjenu. Da bi se sam razvoj proizvoda značajno ubrzao, nužno je smanjiti udio vremena potrošenog na repetitivna ispitivanja softvera i korisničkog ponašanja, te preusmjeriti vrijeme u razvoj novih značajki. Kao i svaka softverska tvrtka, razvijatelji proizvoda pokušavaju ubrzati navedene procese ispitivanja kreiranjem simulacije kojom bi emulirali stvarni sustav i na taj način testirali ponašanje hardvera. “Hardver u petlji” je standardna metoda softverskog ispitivanja opće prihvaćena kao jedan od bitnih razvojnih koraka proizvoda.

Da bi hardver funkcionirao kao planirano, potrebno je uspostaviti funkcionalni komunikacijski lanac od nadređenog regulatora do simulacije, kao na Slici 1.

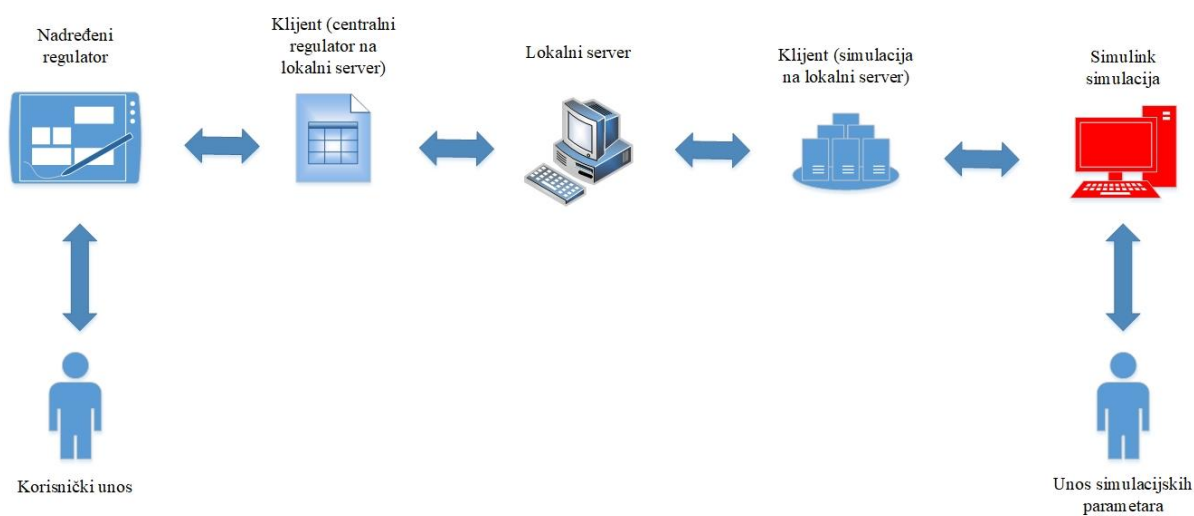

Slika 1. Hardver u petlji

Fokus diplomskog rada bio je na razvoju kvalitetne, brze i modularne simulacije u stvarnom vremenu, koja bi omogućila ispitivanje regulatora i praćenje njegovih odziva. Sustav se sastoji od kontrolera, simulacije u računalnom paketu Simulink, lokalnog servera i dvoje računalnih klijenata koji služe za pristup točno ciljanom, mapiranom signalu na serveru. Krajnji cilj razvoja je automatizirati softversko testiranje pokretanjem testnih skripti u programskom jeziku Python.

Simulacija se može podijeliti na dva glavna dijela: VRF sustav i građevinu, koji pružaju potpunu razvojnu slobodu u kontekstu odabira broja grijanih/hlađenih zona, broja unutarnjih jedinica, te definiranja fizikalnih veličina građevine po volji. Složenost građevine nije ograničena brojem zona zbog korištenja tzv. rezistivno-kapacitivnog modela građevine, koji je preslika strujnog kruga. Vanjski i unutarnji zidovi te strop promatraju se kao toplinski otpori, a ujedno kao i toplinski kapaciteti. Osim navedena dva dijela, za kreiranje potpune simulacije, moguće je proizvoljno odabrati period godine, 50ak lokacija s učitanim vremenskim parametrima te unutarnje dobitke zona boravkom ljudi, toplinom koja se odaje uređajima i rasvjetnim tijelima (Slika 2).

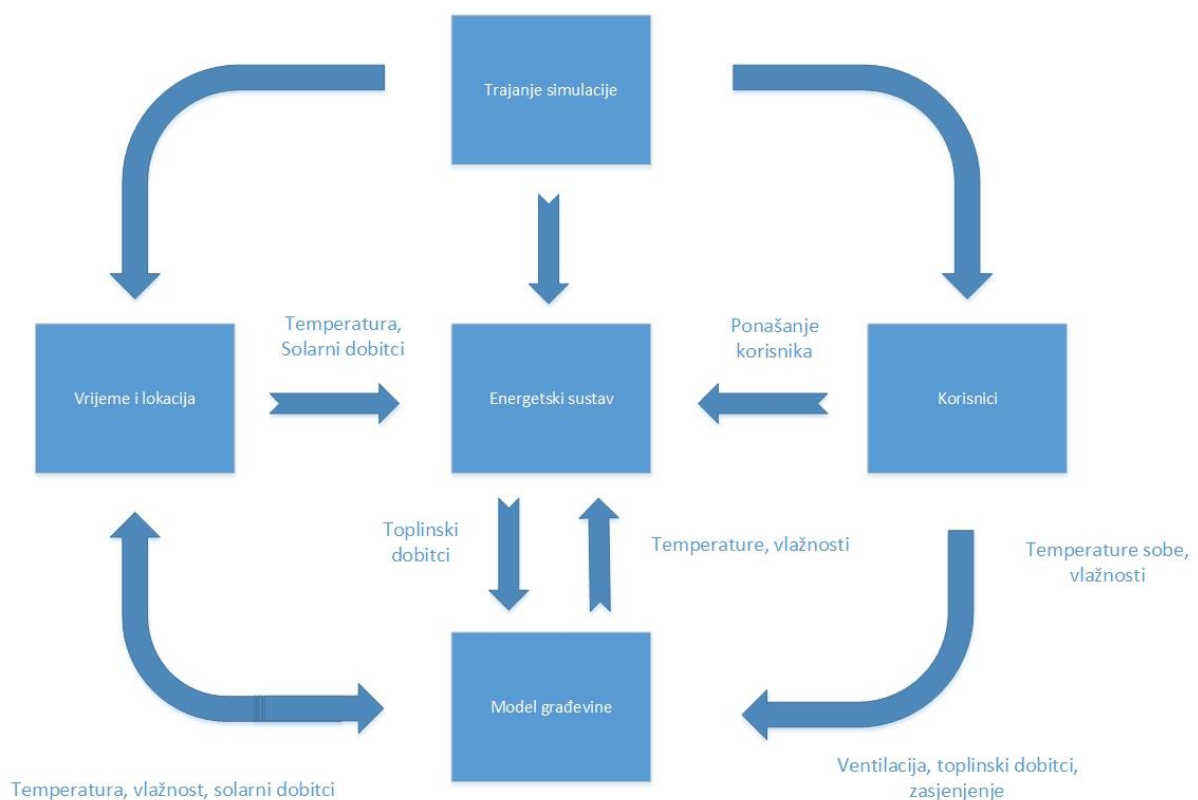

Slika 2. Međupovezanost inicijalizacijskih blokova simulacije

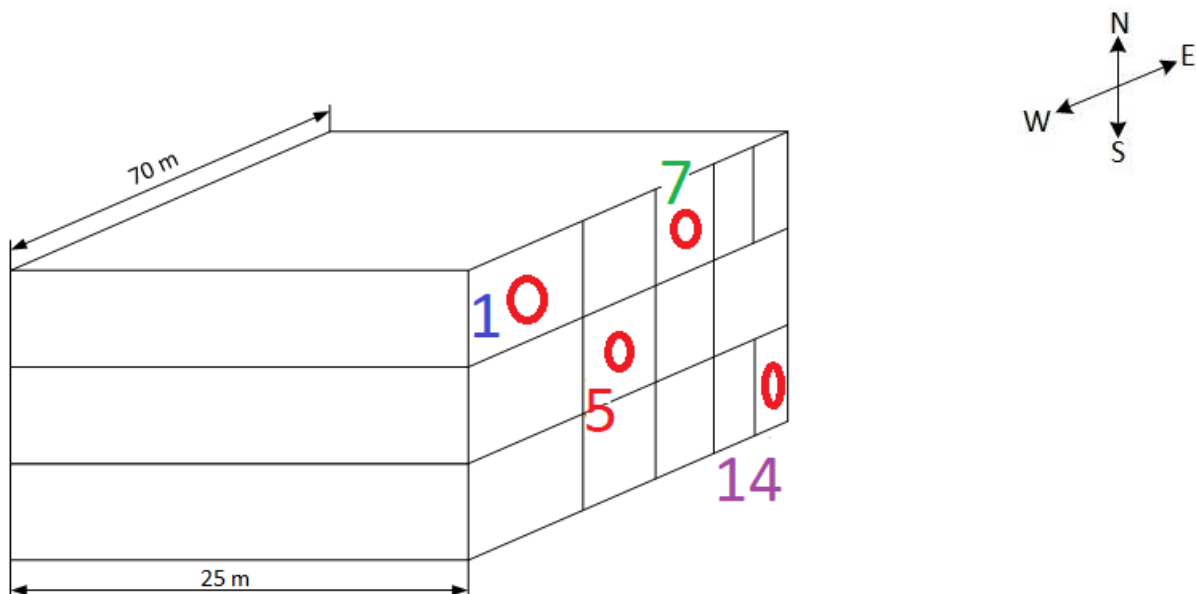

Slika 3. 3D model građevine i odabir karakterističnih zona

Ispitivanja predloženih konfiguracija trokatnice na odabranoj lokaciji (slika 3), koja odgovara Madridu u srpnju, daju rezultate na Slici 4.

Svaki rashladni sustav sastoji se od maksimalno 5 zona, kojima zajedno upravljaju 3 vanjske jedinice, te do 16 unutarnjih jedinica po zoni. Broj jedinica po zoni odabire se u modelu regulatora, te u slučaju dobivenih rezultata iznosi 96. Sve unutarnje jedinice unutar jedne zone rade na istoj postavljenoj temperaturi te jednoliko distribuiraju rashladni/ogrijevni učin po svim unutarnjih jedinica sustava. Predložena konfiguracije KGH sustava može se vidjeti na Table 3.

Iz slike 4, može se iščitati poddimenzioniranost VRF sustava u određenim zonama, dok u ostalima kvalitetno održavaju postavljenu temperaturu od 23 °C, u intervalu od 21 do 25 °C. Slika 5 prikazuje izmjenjene toplinske tokove točnije učin hlađenja istih zona. Cilj ovih grafova je ilustracija funkcioniranja poddimenzioniranog VRF sustava (regulatora, unutarnjih i vanjskih jedinica) spregnutih s objektom u koji su instalirani.

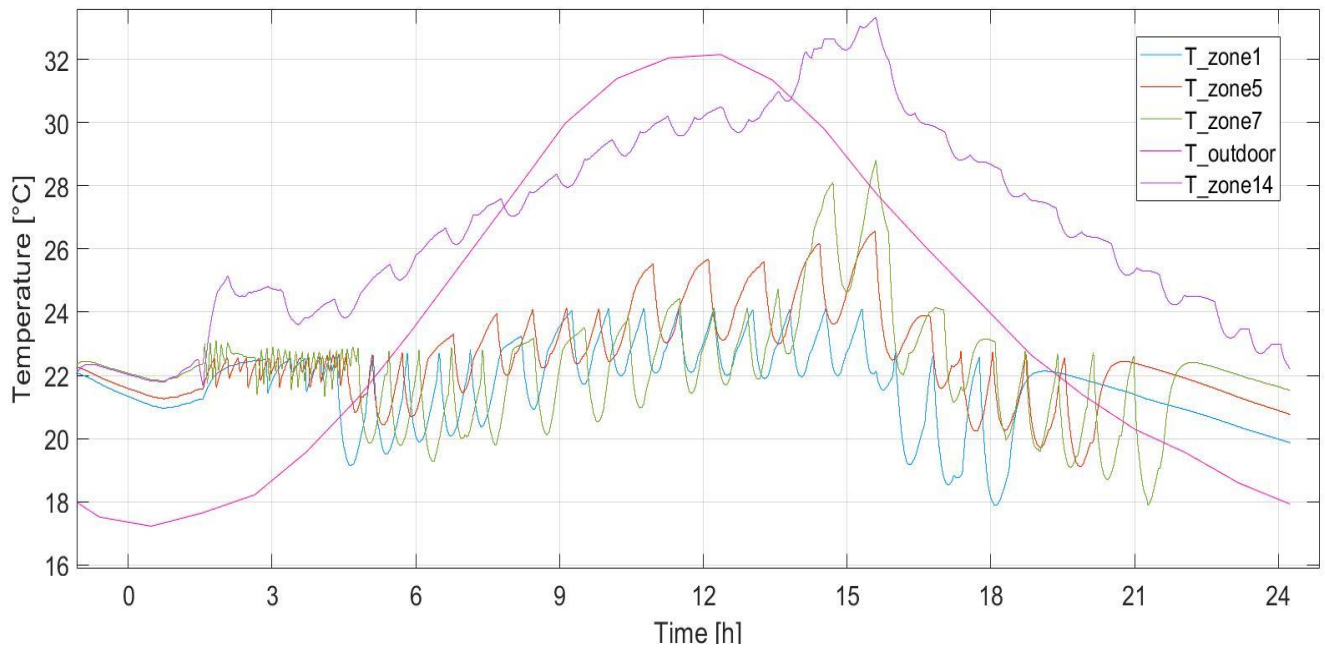

Slika 4. Predložena zgrada sa 95 unutarnjih jedinica i 12 vanjskih

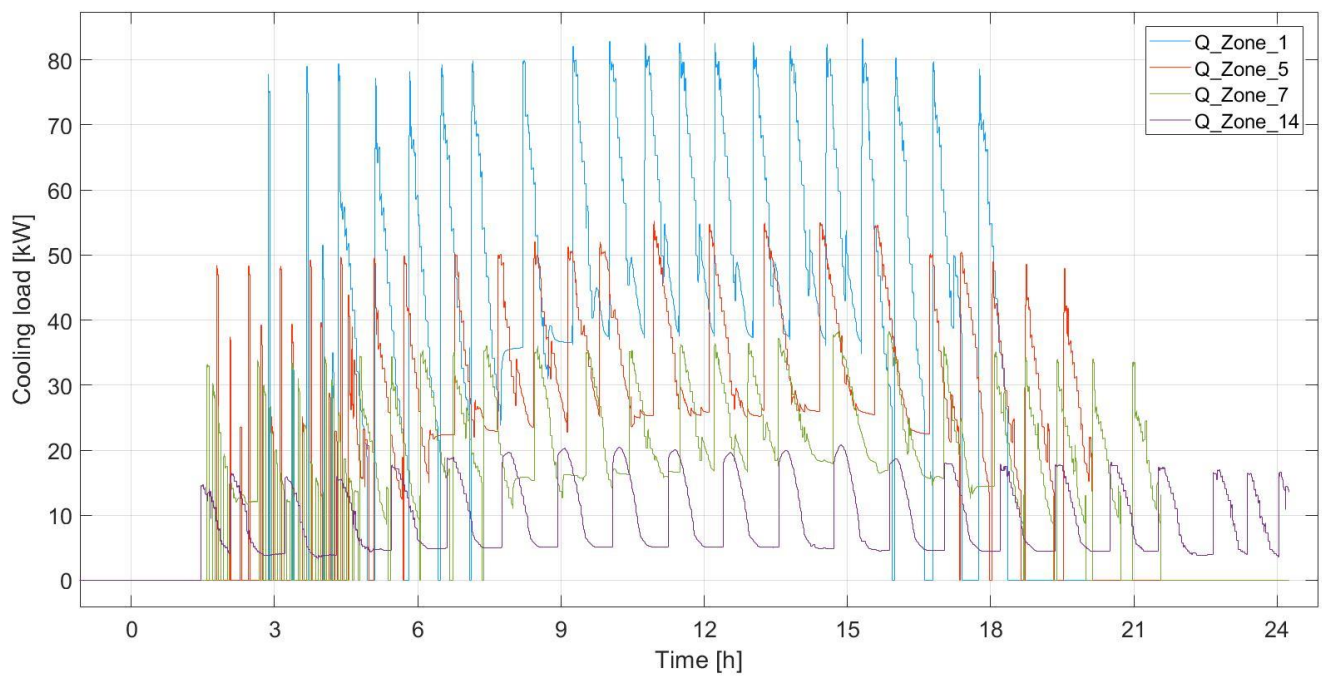

Slika 5. Izmjenjeni toplinski tokovi po zonama

1. Introduction

Developing a new product from the scratch can be a complex, demanding and time consuming process for all engineers and managers. Building a product that is capable of fulfilling all desired criteria with new design and alluring features, that can also be successfully sold on the global market requires a lot of effort.

Deadlines for development of products, that are usually set from manager boards, are often too ambitious, sometimes not taking testing and evaluating time into consideration, which can increase time pressure on development teams. Consequently, many companies are trying to optimize their most time-consuming parts of development, including testing. Details of testing approaches will be explained in later part of the thesis, but building a system that is modular and in which components can be easily (de)attached from/to the system loop is what most of the companies seek for nowadays. During the development a component is subjected to multiple levels of testing, which will be later explained in more details by V-model testing graph.

Over the years, borders between engineering fields are being erased and interdisciplinarity is becoming a more demanding skill. Proof for that is a car development (electrical vehicle, autonomous driving), growth of electronic parts (controllers, sensors, regulators) in all components and application of variety of software solutions, which all exponentially increase the complexity of the products. Merging all these parts together without testing them earlier can lead to accumulation of errors, which can be avoided by using modern software tools and simulating desired scenarios.

Simulating physical and chemical processes, weather forecasts, economical expectations, gaming experiences or basic natural behaviors of systems are becoming more important during the development of products. Time spent on building real systems is substituted for setting up a simulation, whose parameters can be easily changed, taking a proper initialization into a consideration.

The goal of this thesis is to prove applicability of modular, dynamic, simulated VRF (Variable Refrigerant Flow) system, and conduct automated system tests and user cases on a simulation. Used system will be consisted of multiple variations of VRF components, running under different conditions and with various criteria in order to simulate various use cases and to provide highest possible test coverage of used software.

1.1. Motivation and thesis objective

Core motivation to automate system testing lays upon a fact that lots of working hours are spent to test basic use cases that can be easily automated, written and executed.

Traditionally, engineers spend a lot of hours in front of test walls, configuring different test cases, configurations in real systems and testing corner cases. Everything can be simplified by making virtual representation of VRF system with custom number of parameters and heating/cooling zones, which will reduce preparation time for testing future products and implemented features. Only time needed is to make fully functional Simulink model of the device/feature and to put it in a simulation loop, together with setting up a desired test bed infrastructure and finally running test automation framework.

Goal of the thesis is to make a custom virtual VRF system as a part of (Simulation Library) library and implement already developed central controller (CC). This way a lot of time can be saved while not executing repetitive use cases, fixing bugs in initial phase of development (Figure 1) and reinvesting that time in developing products, improving Simulink models and getting a better system's behavior understanding.

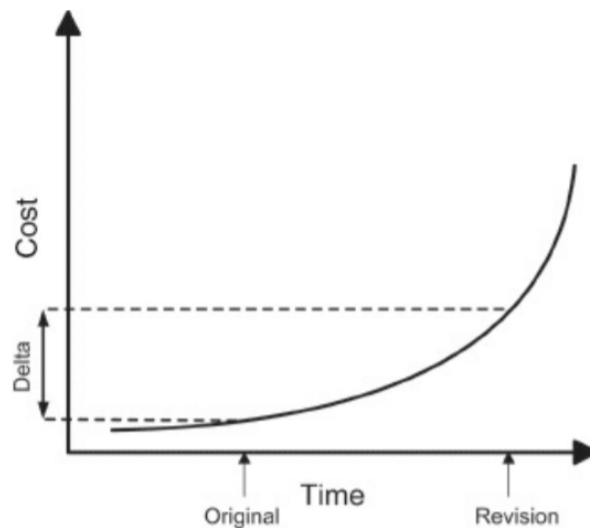

Figure 1. Cost-of-change curve

1.2. Hardware-in-the-Loop overview

Hardware-in-the-Loop (or HiL) is a testing technique where real signals from the hardware (in this case controller) are connected to a test system that simulates reality, tricking the controller into thinking it is in the final product. Test and design iteration take place as though the real-world system is being used. It is easy to run through millions of possible scenarios to properly employ and test your controller without the cost and time associated with actual physical tests done by tester. [1]

A HiL test replaces the system with a simulation comprising hardware and software that interacts with real I/O as though the physical system was present. Due to the fact updates can be made in the software, you can quickly incorporate simulation or controller's software changes, test a wide spectrum of relevant scenarios, and expand test coverage as needed to fearlessly and comprehensively test without risk to a physical, usually very costly system.

Careful selection of software and hardware has to be done to ensure maximum test coverage while minimizing time spent on system setup and usability. Additionally, to keep pace with rapidly changing market requirements, you are tasked with finding a solution that addresses not only this test but also the next, necessitating testers that are customizable and future-proof. HiL concept is used primarily to test developed software on the controller against some virtual environment, which is usually represented as a simulation environment.

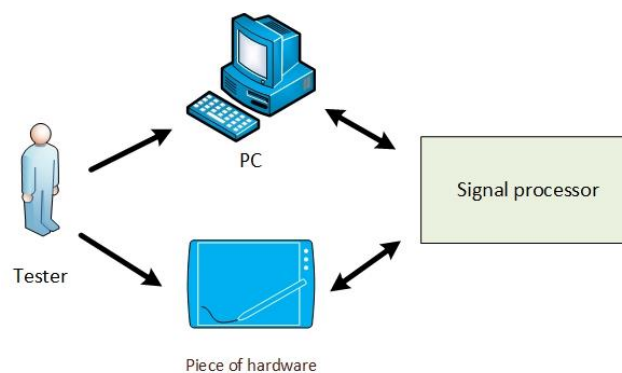

Figure 2. General HiL scheme

As seen in the Figure 2, basic HiL configuration doesn't require many components, piece of hardware, PC to show results from the simulation's environment and signal processor. The last one can be easily bought on the market and thoroughly connected to other components. On the other hand, signal processor can be developed, which demands more time but then tester can have a better insight of system's signal interaction.

Final stage of product's development is deploying it in a real system and observing software's behavior. In the Figure 3, real application of the central controller (CC) is shown. Controller should be able to get connected to big VRF system consisting of multiple IDUs and ODUs and to control them individually, having all important parameters visible on the touchscreen and being controllable.

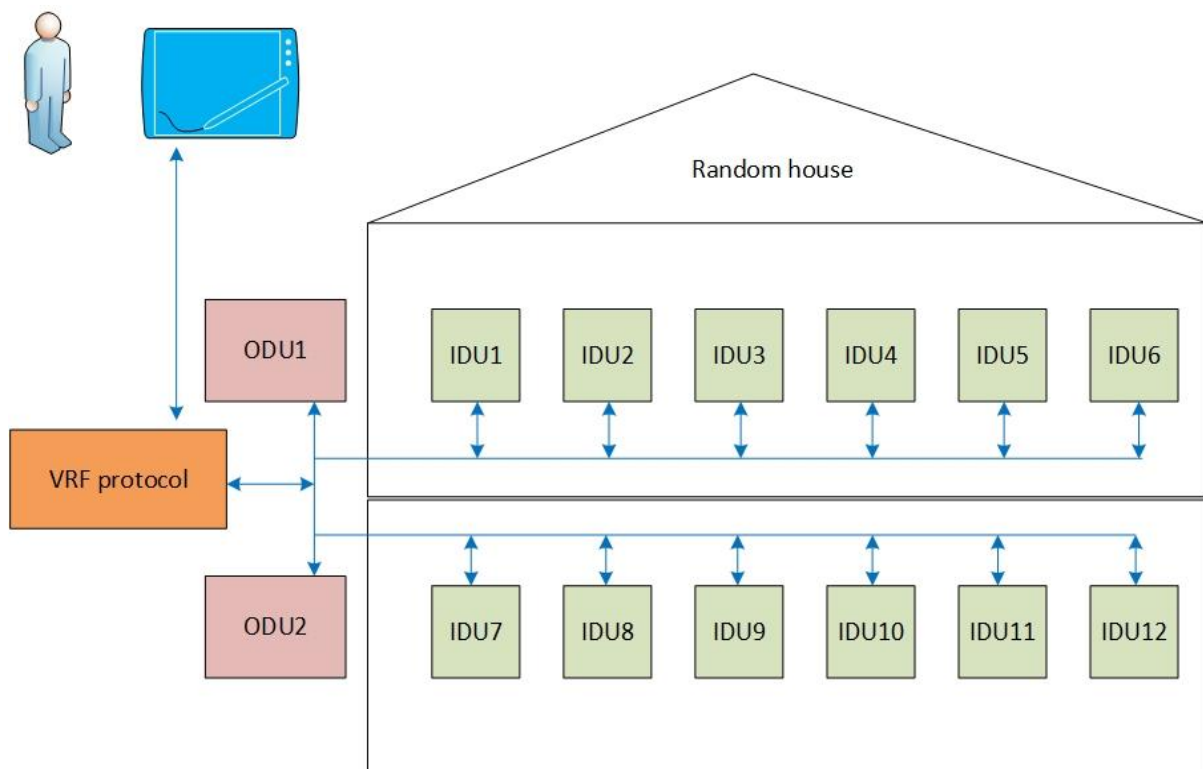

Figure 3. Real HVAC system with control unit

In this application, Simulink will be used to create that environment with other parts of the scheme used to build up a custom made loop of data, going from Simulink's output, through clients on local server, ending from another client all the way to the controller (Figure 4).

On the current market, there are already high-end solutions provided together with Simulink software, but in this application, there are custom made pieces, which successfully combined together make bidirectional flow of the data.

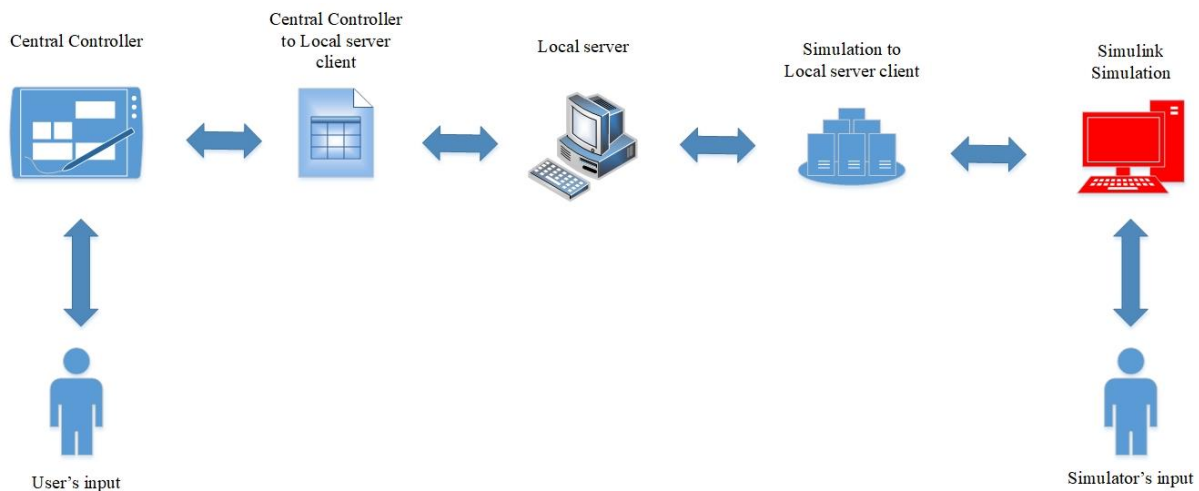

Figure 4. Applied Hardware-in-the-Loop scheme

Simulator is a professionally educated person, who sets up a simulation in a desired way to fulfil test's experienced behavior, for example number of heating/cooling zones, number of indoor and outdoor units, switching logic between working modes, size of the building and the zones, RC model entering parameters etc. Simulation (marked red on the scheme) consists of two main parts: building model and VRF system's model.

After running the simulation on the Simulink, data is transferred using client directly to local server and stored there. By periodical request (or polling) of central controller, at any point of time, local server has to respond with current status of parameters stored on local server.

In the case that user changes some basic settings on CC, data is directly fetched to local server over the client. After being stored on local server for some time, simulation is polling for the update of the local server values. Once the change is observed, data from local server is transferred back to simulation and has direct influence on simulation's behavior. Whole system runs in a real-time application, putting timing and triggering logics of the whole loop to the test.

1.3. Central controller

Central controller (CC) is a piece of a hardware being tested against the simulation inside HiL. Main part of test is CC's software behavior under great signal stress generated by simulation. On the screen of the central controller, there are a lot of alluring features to be found. Focus of this testing is going to be basic user's functions, such as turning on and off, mode change, fan speed level, setting a desired temperature etc. The screen shows parameters for every IDU (Figure 5) like working mode, fan speed level, target temperature, temperature limitations etc. CC is designed primarily for managers who can have an overview of all mentioned parameters of deployed VRF system from a single device. If the application of the VRF system is in a hotel, there is also another device for visitors called room controller. That one is usually mounted on the wall inside each room, providing basic controls for guests, without showing any additional data for the unit, apart from the one visitor can have control of.

The device constantly polls for updates conducted in the VRF system, reaching initially the ODUs for status query, proceeding to corresponding IDUs visible from the side of ODU.

By plugging in the cable, it is possible to read polling communication and responses of the devices, allowing faster fix of potential software errors visible on side of communications protocol.



Figure 5. Central controller [2]

1.4. V model

The verification and validation of requirements are crucial part of system and software engineering. Importance of verification and validation caused traditional waterfall development cycle to bend to so called “V model”. [3] It links early development of the software to their corresponding activities, which can be separated into 4 categories:

- Analysis
- Demonstration
- Inspection
- Testing.

Analysis uses established technical or mathematical models, simulation, algorithms to determine whether a work product meets its requirements. Demonstration is a visual examination of the execution of a work product under predefined and specific scenarios, with the same final outcome. Inspection requires physical manipulation or electromechanical measurements to finalize it with visual examination in order to check if it meets its requirements. Last one is testing, which means stimulation of an executable work product with known inputs followed by the comparison of its actual with required response, to determine whether it meets its requirements.

V model is a simple variant of waterfall development model of system or software development. As seen in the Figure 6, V model emphasizes verification and validation by bending the waterfall model by putting them to the same level of importance as development. The left side represents the analysis activities that decompose the users' needs into small, manageable pieces, while the right side of the V shows the corresponding synthesis activities that aggregate and test these pieces into a system that meets the user's needs.

V model has both advantages and disadvantages. It shows the engineering activities in a logical flow that is understandable and balances both development activities and testing. On the other hand, it is a great oversimplification of the development process, avoiding iterativity of the development. Another potential issue is not a strict distinguishing among unit, integration and system testing, as the system on the first sight suggests. At the current development stage of the product, for application of HiL, system testing is conducted, which checks system's requirements.

To better understand the testing stages of V model, they can be derived from requirements and specifications, design artifacts or the source code and separated in few steps: [4]

- Acceptance testing – assesses software with respect to requirements or user's needs
- System testing – assesses software with respect to architectural design and overall behavior
- System integration testing – assesses software with respect to subsystem design
- Subsystem integration or module testing – assesses software with respect to detailed design
- Unit testing – assesses software with respect to implementation.

In the Figure 6, so called V model is shown, illustrating typical scenario for both development and testing levels and how they relate to software activities by isolating each step. Information for each test level is typically derived from the corresponding development level. Early error findings is the best way for ultimate cost reduction, as seen in the Figure 7, showing increase of the final product price in the case of late error findings.

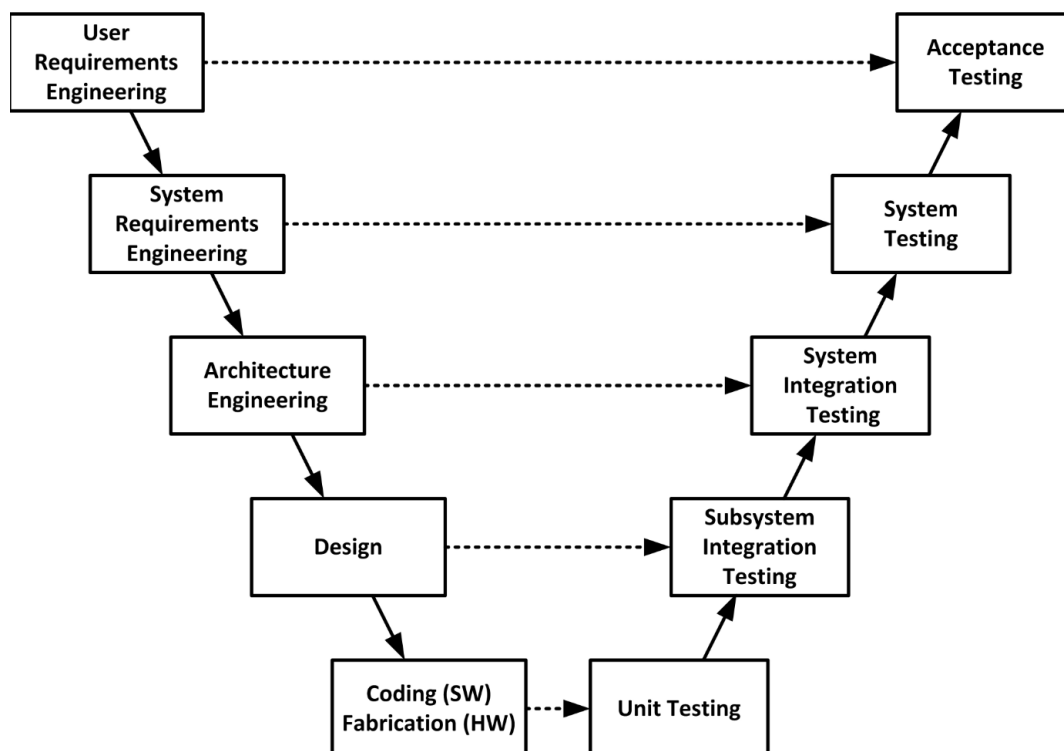

Figure 6. V-model software development

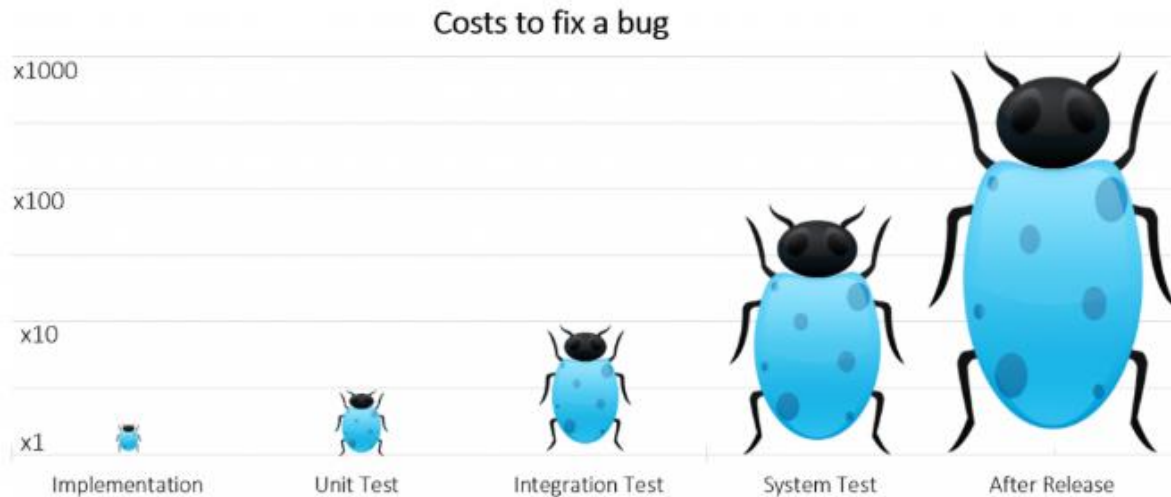

Figure 7. Cost of fixing bugs in different V-model areas of development [5]

1.5. Model Based Development

Model Based Development (MBD) is a mathematical and visual method of solving and addressing problems associated with development of complex products, controls, signals and communication devices. It is used in many motion controls, industrial equipment, aerospace and automotive regulation, and generally applied in designing embedded software.

MBD provides an efficient approach for establishing a common framework for communication throughout the design process while supporting well established development cycles, such as V-model, see above.

In comparison to traditional design that uses complex structures and software code, designers using MBD define building blocks of the model, which leads to rapid prototyping, software testing and verification.

In the case of VRF model, process of MBD can be separated into few steps:

- a) Modelling a system and all its components properly
- b) Analyzing and developing controls for the system
- c) Simulating previous two steps
- d) Integration of first 3 steps and deploying of a controller

Ad a) Modelling of a system and its components can be data driven or according to some physical laws. In this case laws of conservation of energy and thermodynamics are used. The latter one is based on creation of block diagrams that are consisted of differential-algebraic equations of system's dynamics and present physical modelling where blocks are interconnected presenting elements or a system as a whole.

Ad b) Analyzing controls for the system is used to define dynamical characteristic of a system's model. Controller of the system can be generated from characteristics based on system's behavior.

Ad c) To better understand the controlled behavior of the system, basic simulation and real-time application are applied, to investigate complex system and its time responses. Simulation allows specification, requirements and modelling errors to be found at this stage, rather than in later development phase. Real-time simulation uses automatically generated code for the controller developed in step b). The code is deployed to a real-time prototyping computer that can run the code and control the system's behavior.

Ad d) Deployment is ideally done via code generation from the controller. It is unlikely that the controller will work on the actual system as well as it did in simulation, so an iterative debugging process is carried out by analyzing results of the actual target and updating the controller model.

MBD tools allow all these iterative steps to be performed in a unified visual environment. While MBD can easily simulate test scenarios and give better understanding of simulation outputs, in real world production environments it is usually not suitable. Reason for that is creation of end-user tools that don't show the debugging process and is much different to regular system model development.

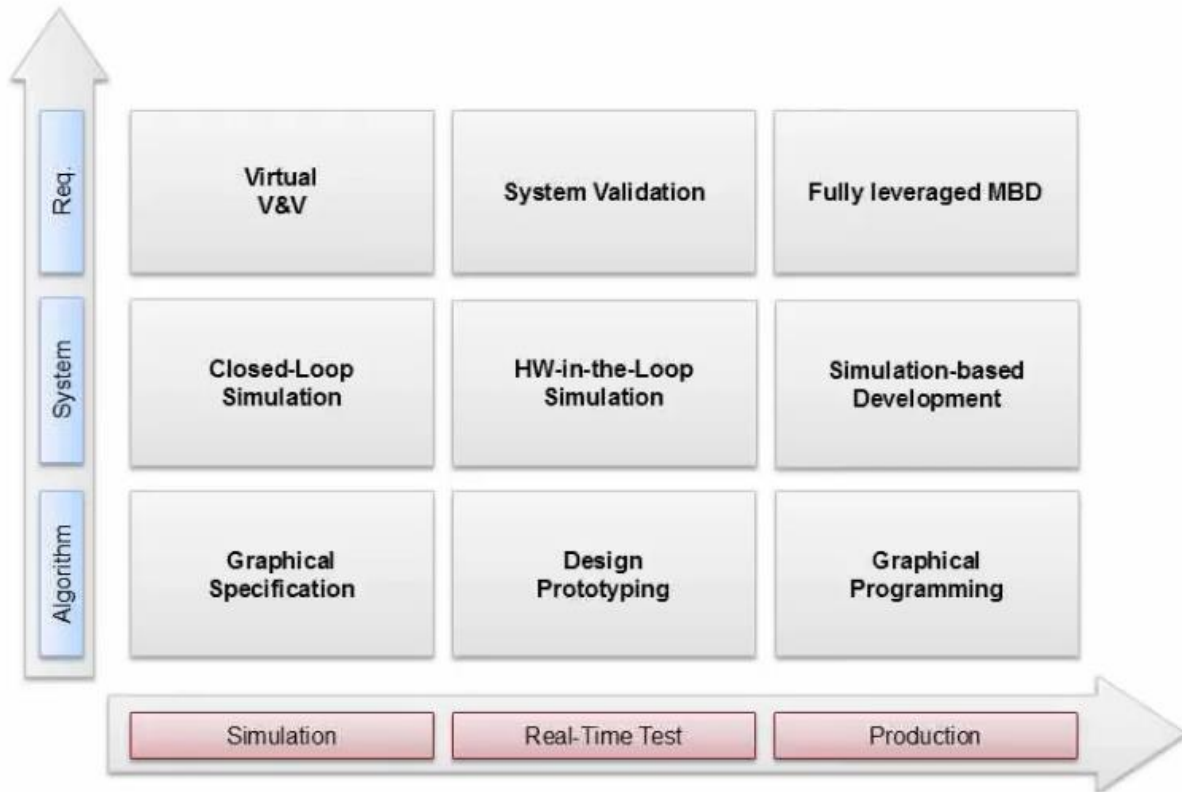

Figure 8. MBD Adaption grid [6]

MBD product development and adoption grid is shown in the Figure 8. It is used to explain MBD full integration of the presented models and development steps. X-axis of the Figure shows different layers of applicability, starting from offline simulation on local PC, proceeding with real-time system application and finalizing with application on a production line.

Graphical specification is a graphical entity visually showing interconnection of the parameters. It is used to specify the design of the system and its basic functionality. Closed-loop simulation consists of control and system model to do basic analysis and testing of system's behavior on PC, before switching to real-time system or production line.

Virtual V&V is checking if designed model is fulfilling all requirements before being deployed on a real system.

In the second column, focus in the thesis would be put on HiL and System Validation process to see its behavior. Production column is not in the focus of the thesis.

1.6. Software testing

Software is a key ingredient in many devices and systems that pervade our society. It defines the whole Internet, modern stock exchanges, telephone, virtual gaming and many other modern society infrastructure. It is also an essential component of embedded applications in traffic, household appliances, spaceships, cars, garage openers, smartphones etc. [7]

Modern households have around 50 processors and brand new cars can go up to 100, permanently running software that most of the people hope it will never fail. This is where testing of the software comes to a light, as a method for software evaluation.

Software testing is inherently complicated and ultimate goal of completely correct software is unreachable. 100% correct engineering solutions do not exist, but seeking for expected behavior is acceptable within consideration of a large number of factors including reliability, safety, maintainability, security and efficiency. The Model-Driven Test Design (MDTD) process breaks testing into a series of small tasks that simplify test generation. Afterwards engineers isolate their tasks and work at a higher level of abstraction by using mathematical engineering structures to design test values independently of the details of software or design artifacts, test automation and test execution. Key intellectual step in MDTD is design of use cases which are used as a reference for determination of testing success or failure.

One of the most common testing approaches is “human-based” approach, where a test engineer uses domain knowledge of the software’s purpose and his/her experience to design tests that will be successful in finding potential issues. Alternatively, tests can be designed to satisfy well-defined engineering goals such as coverage criteria.

“Software testing is vitally important in the software development process, as illustrated by the growing market for automated testing tools. Moreover, software testing generally consumes between 30 and 60 percent of the overall development effort. [8]

Many companies are already using automated test execution tools. Model-based testing pushes the level of automation even further by automating the design, not just the execution, of the test cases. Model-based testing tools automatically generate test cases from a model of the software product. This gives a repeatable and rational basis for product testing, ensures coverage of all the behaviors of the product, and allows tests to be linked directly to requirements. Intensive research on model-based testing in the last 5 to 10 years has demonstrated the feasibility of this approach, has shown that it is cost-effective, and has developed a variety of test generation strategies and model coverage criteria.”

Main motivation of building a HiL is to test the software of the CC to its maximum, checking communication protocol, as well creating the gateway to test automation framework. The latest one is the final goal of most of today's software developer teams, refocusing time and effort on more lucrative development parts.

2. Simulation

In this part of the thesis mathematical model of VRF system and building physics will be provided with simulation parameters in more details.

There are two big interconnected parts that have to be distinguished:

- VRF system
- Building model

VRF system consists of IDU, ODU and CC Simulink models that represent the real system in a simulation, whereas building model is a representation of a real building with all corresponding building bricks (windows, walls, zones...).

2.1. Simulation library

Simulation library models are fully dynamic engineering models with a library of simulation blocks that can be linked within MATLAB Simulink environment, which allows modelling, simulating and analyzing linear and non-linear dynamic systems in continuous and discrete time-steps. Simulink is a sub environment of MATLAB, which uses the MATLAB coding system, allowing the block-based models to be edited and arranged graphically. Simulink models of indoor units (IDUs), outdoor units (ODUs) and central controller (CC) have already been developed and tested by development teams inside Bosch, making them as modular as possible, with emphasis on different cases that could be applied in regular residential cases (hotels, tenant and business buildings). There are also various Bosch indoor unit's incoming parameters that are being calculated inside the models. Parameters such as running mode, temperature of entering air and incoming temperature from outdoor units are all needed to punctually simulate indoor unit and present it as a real entity inside simulation environment, increasing trustworthiness of the virtual representation of a unit. With good evaluated models, reliability of the whole system will increase significantly.

By expanding Simulink models, complex systems can be simulated and interconnected in order to imitate behavior of big VRF systems including 50+ indoor units.

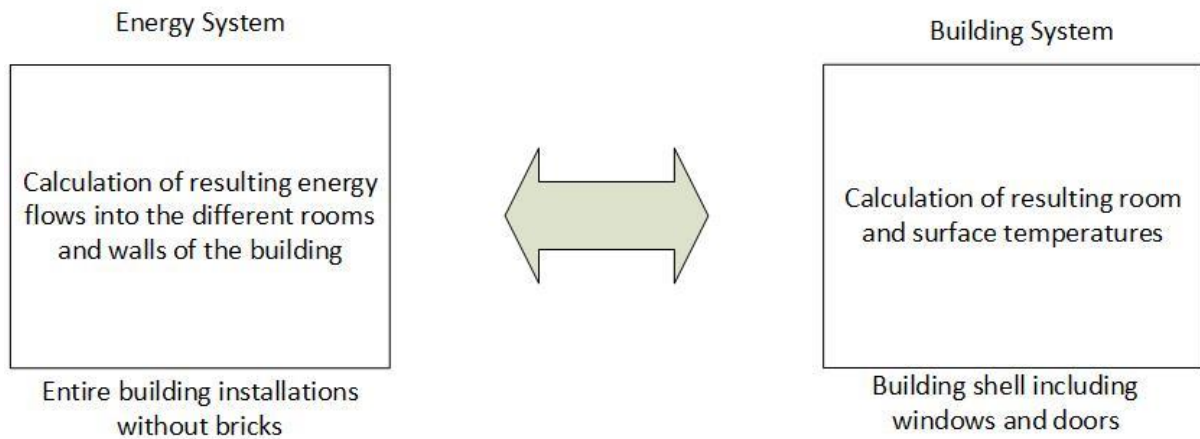

Figure 9. Scheme of simulation's temperature and energies interrelations

2.1.1. Simulation library initialization blocks

Simulation library initialization block parameters can be separated in:

- simulation control
- environment
- user block
- VRF system
- building model.

Each one of them has their initial values, which allows this system to be modular, all together forming a dynamical system with interdependency of blocks among themselves, as shown on Figure 10. Heat demand of the single zone is being calculated according to DIN 12831 norm.

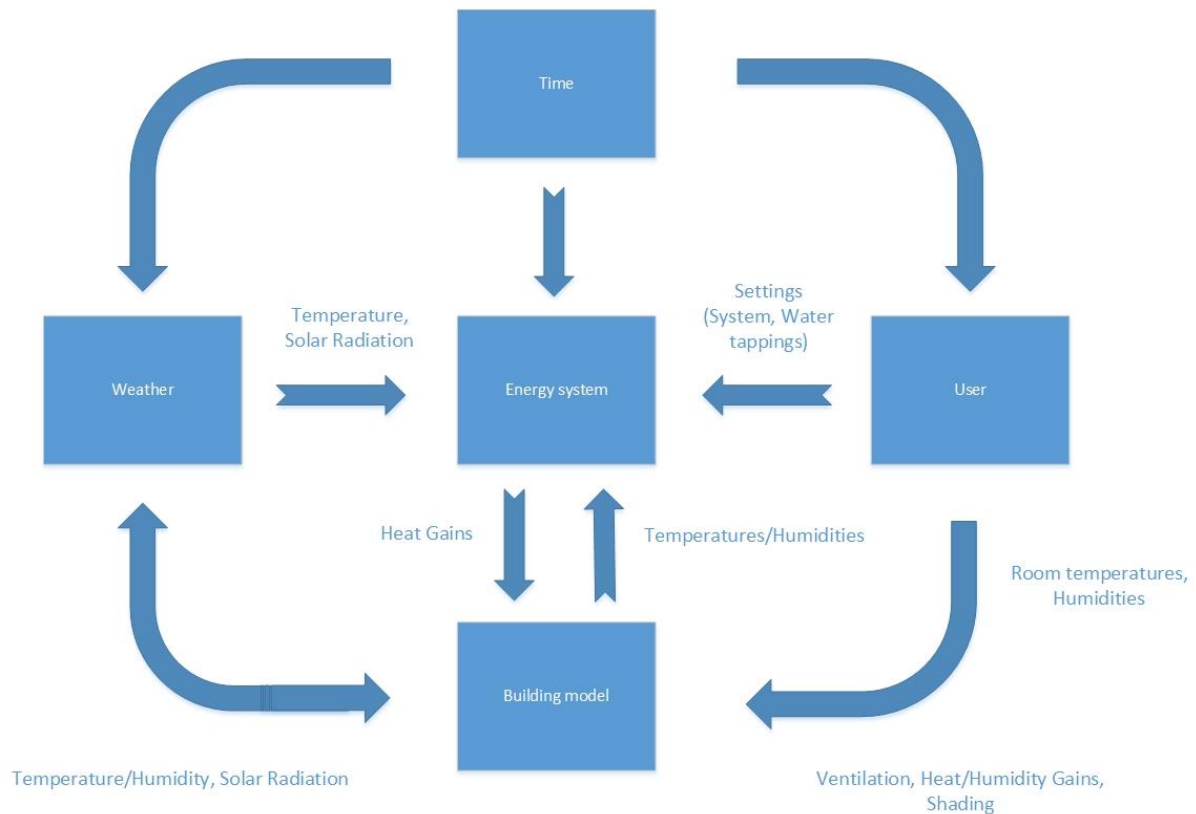

Figure 10. Simulation initialization values interconnection scheme

Simulation control / Time

Time block consist of all simulation parameters that override basic Simulink entering parameters. Data such as the day when the simulation has started, month and hour of start and simulation time step are to be selected in order to simulate VRF system in preferred time span, either through heating cycle (approximately from October to April) or the cooling one (the rest of the year), or both.

Environment

Environmental model block of Simulation library gives an opportunity to select multiple worldwide cities, which are all interrelated with their weather data saved in a form of Excel document. Apart from the basic value that we would expect (e.g. temperature), this block also gives punctual information about humidity and irradiance.

User

Inside this block it is possible to choose a couple of different types of internal gains, human heat dissipation inside the construction (pensioners, standard working people, athletes, big families) and usage of electronic and household devices, CO₂ increase due to respiration, ventilation habits etc.

VRF system

This Simulink block initializes the number of zones by reading the selection of them in building model block, as well as IDUs number, ODU's, set temperatures per zone and control functions. It is one of the two main parameters of the simulation, which has a significant influence on the simulation's outcome. This block gives testing freedom for number of already mentioned parameters, making it the most changeable block in comparison to other. The next block is once initialized for the building selection, while this one is used for better optimization of the simulation. There are all Bosch's IDUs and ODU's available on the market to be selected from the drop down menu, including their specific parameters such as: length, depth and height of the coil, tube diameter, tube's both longitudinal and transversal pitch, fin's thickness and density etc.

Building model

This building model generates a number of equations in order to calculate few basic parameters to define a building model dynamics. Building model can be extracted into multiple zones, which can be activated or deactivated. Inside each of the zones, in further application, finite number of IDUs (less than 64, which is requested from side of communication protocols) will be defined.

Choice of material framing the zone, size and volume of the zone, surface and type of the windows, thermal resistance of material's specific heat capacity, position of the zones regarding insolation and sides of the world, required internal and surrounding ambient temperatures are all to be selected manually, with final goal of presenting the most realistic model of a desired building. Some of them are showed on following pages. All data is calculated in a separated .csv file and used as a source for the simulation. Parameters are generally calculated per zone.

Types of the desired buildings can be calculated by defining a number of zones and floors of the building and defining all necessary, previously described, input parameters.



Figure 11. Real building inspiration [9]

As seen in the Figure 12, reference part of the building is a three floors glass business construction. It is 70 meters long, 25 meters wide with height of 3,5 meters. Distribution of heating/cooling zones are done according to the real building (Figure 11). Bigger zones represent working offices and smaller ones supporting rooms like corridors, toilets and kitchens.

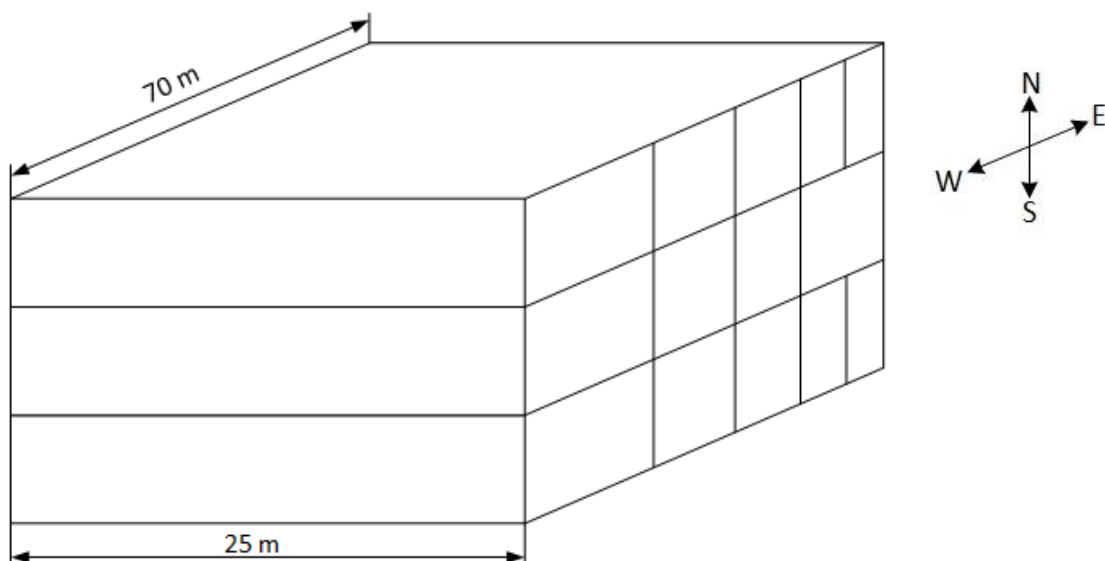

Figure 12. 3D model of a calculated building

Usage of materials for building are listed in Table 1, with their corresponding thermophysical parameters (e.g. heat conductivity, emissivity and specific heat capacity).

Table 1. Physical properties of important building elements

Material/substance	Heat conductivity [W/m K]	Specific heat capacity [J/kg K]	Density [kg/m³]	Emissivity [-]
Concrete	1,65	1000	2200	0,93
Insulation (mineral wool)	0,03	1030	10	-
Grout	1,2	1000	1800	0,93
Air	-	1005	1,2	-
Water	-	4180	1000	-
Steel	50	450	7850	-

To define construction elements of the building, Table 2 was created. Wall consists of 10 centimeters of isolation, while ceiling has 15 centimeters, coupled with double-glazed glass window it ensures low heat transfer through building outer layer. Values listed in that table, provide an input for heat transfer values.

Table 2. U-value for different layers of the wall

Component	Layer	Thickness [m]	U-value [W/m² K]
Wall	Concrete	0,24	0,27
	Insulation	0,1	
	Grout	0,02	
Ceiling / Roof	Concrete	0,2	0,18
	Insulation	0,15	
	Grout	0,02	
Windows	Double-glazed	-	1,4

Building test case requires generation of multiple heating/cooling zones and corresponding number of IDUs and ODU's stored inside. In the Figure 13, numeration of zones is explained with representation of exact number of IDUs and ODU's per zone in the Table 3. They work all together, distributing the same heating/cooling load evenly among themselves. Smaller zones have lower heating/cooling load due to size and temporary occupancy of people in toilets, kitchens etc. On the other hand, big zones have more units in order to cover the higher loads.

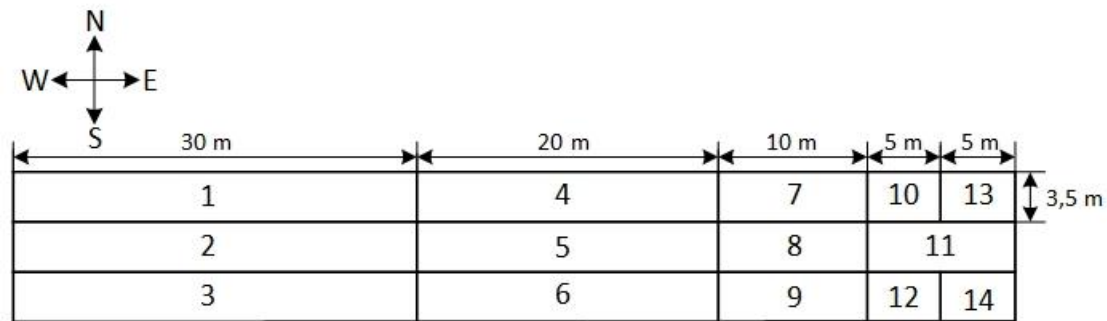

Figure 13. 2D view of calculated building and numeration of the zones

Table 3. Initial configuration of big VRF system (95 IDUs and 18 ODU's)

Zone number	Number of IDUs	Refrigeration system number
1	16	1
2	16	2
3	16	3
4	10	4
5	10	
6	10	
7	3	5
8	3	
9	3	
10	2	6
11	2	
12	2	
13	1	
14	1	
Total	95	-

2.2. Resistive-Capacitive (RC) Thermal Dynamics model

Resistive-Capacitive (RC) Thermal Dynamics model has most of its roots in field of electrical engineering, with wide application in the field of modern technology (e.g. capacitive sensors, trackpads, modern touchscreens, tablets etc.).

Similar logic from electrical engineering can be transferred to energy and civil engineering and simple calculation of thermal resistances and heat capacitors. The equation of heat balance that will be shown later, is equivalent to the conservation of electric current at the corresponding node. [10]

Apart from definitional explanation of basic 3R2C model (Figure 15) of the building envelope, there are also much more complex models being used for complex heat transfer calculation in urban areas and incorporating different temperatures, reflection from asphalt as a source of heat etc., what can be seen in the Figure 14.

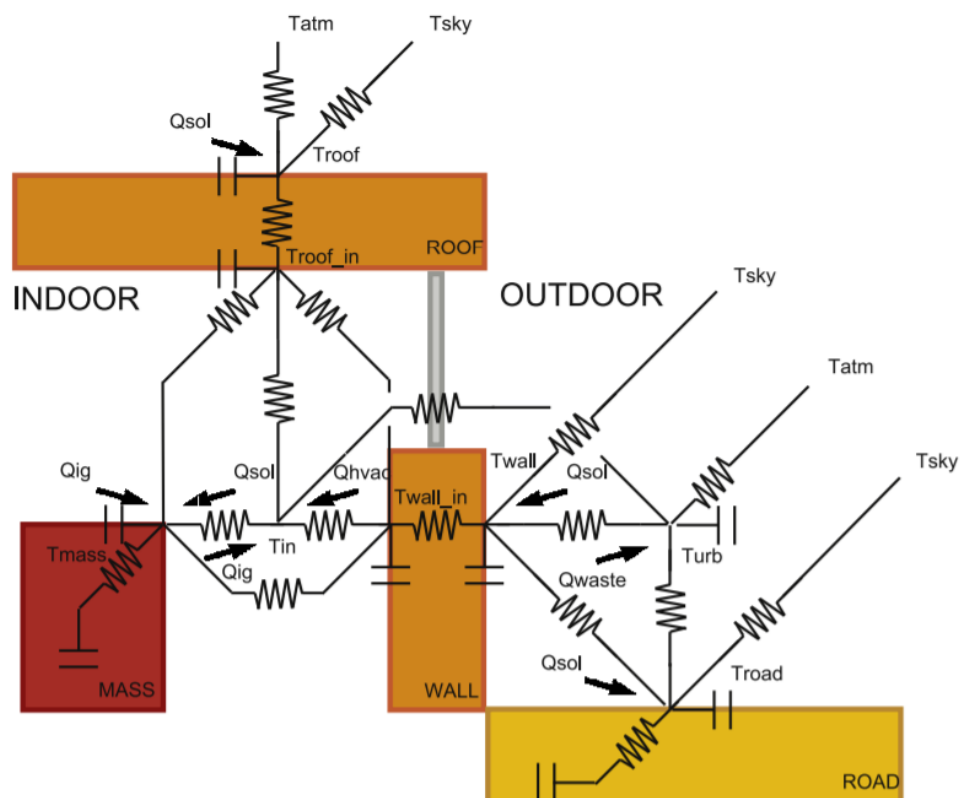

Figure 14. Urban house RC model [11]

The heat transfer model, based on thermal resistance and capacitance (RC), has been widely adopted in civil and mechanical research communities. [12] Previous research has evaluated the accuracy of RC models of varied complexity (e.g., 2R1C, 3R2C, etc.) and found that RC model-based simulation can achieve reasonable accuracy in temperature prediction with the root-mean-square error (RMSE) of around 0.5 °C and building energy consumption prediction with the relative error within 10%. [10]

It is given a primer on the fundamentals of the RC model to better explain the readers the necessary background. In the RC model for a predefined building, each zone (e.g., a room, a hall way, etc.) is modeled as a thermal capacitor and each wall is modeled as a concatenation of $n + 1$ thermal resistors and n thermal capacitors, $n \geq 1$. Simply speaking, thermal resistance models the thermal energy flow based on the temperature difference:

$$Q = \frac{\Delta T}{R} \quad (1)$$

where Q is the thermal energy flow [W] transferred across the resistance, ΔT is the temperature difference [K], and R is the thermal resistance [K/W]. On the other hand, thermal capacitance models the ability of space/mass to store heat:

$$Q = C \frac{dT}{dt} \quad (2)$$

where C has the unit [J/K]. In practice, the most widely used RC model is the 3R2C model, i.e., $n = 2$. As shown in the Figure 15, under the 3R2C model, the wall separating two HVAC zones i and j in a building is composed of three thermal resistors (R_{i1} , R_{12} , R_{2j}) and two thermal capacitors (C_1, C_2). Also, zone i and zone j are modeled as two thermal capacitors C_i and C_j , respectively. It can be seen that the RC model is analogous to an electric circuit. As a result, the thermal dynamic under the RC model is also closely related to the classical circuit theory. More specifically, let $T_i^{[k]}(t)$ denote the temperature of i -th thermal capacitor at time instant t within time-slot k . It is important to distinguish the two notions of “time” introduced so far.

Brackets “[k]” are used to denote a time-slot k (in a larger time-scale); while in here, parenthesis “(t)” is used to signify a time instant within some given time-slot. Under the RC model, the evolution of $T_i^{[k]}(t)$ is governed by the following first-order ordinary differential equation (ODE):

$$C_i \frac{dT_i^{[k]}(t)}{dt} = \sum_{j \in N_i} \frac{T_j^{[k]}(t) - T_i^{[k]}(t)}{R_{i,j}} + Q_{Ai}^{[k]}(t) + Q_{Hi}^{[k]}(t) \quad (3)$$

Where N_i denotes the set of thermal capacitors connected to thermal capacitor i , R_{ij} denotes the thermal resistor between zone i and zone j (we assume $R_{ij} = R_{ji}$), and $Q_{Ai}^{[k]}(t)$ is the instantaneous thermal power transferred from the ambient environment to thermal capacitor i at time instant t in time-slot k and defined as follows:

$$Q_{Ai}^{[k]}(t) = \begin{cases} \frac{T_A[k] - T_i^{[k]}(t)}{R_{0i}}, \\ 0 \end{cases}, \quad (4)$$

if capacitor i is adjacent to the ambient, otherwise

Where R_{0i} represents the thermal resistor between capacitor i and the ambient environment. $Q_{Hi}^{[k]}(t)$ denotes the cooling power input injected from the HVAC system and defined as follows:

$$Q_{Hi}^{[k]}(t) = \begin{cases} u_i^{[k]}(t), \\ 0 \end{cases}, \quad (5)$$

if capacitor i is connected with HVAC, otherwise

Where $u_i^{[k]}(t)$ denotes the instantaneous HVAC cooling power control decision to zone i at time t in time-slot k .

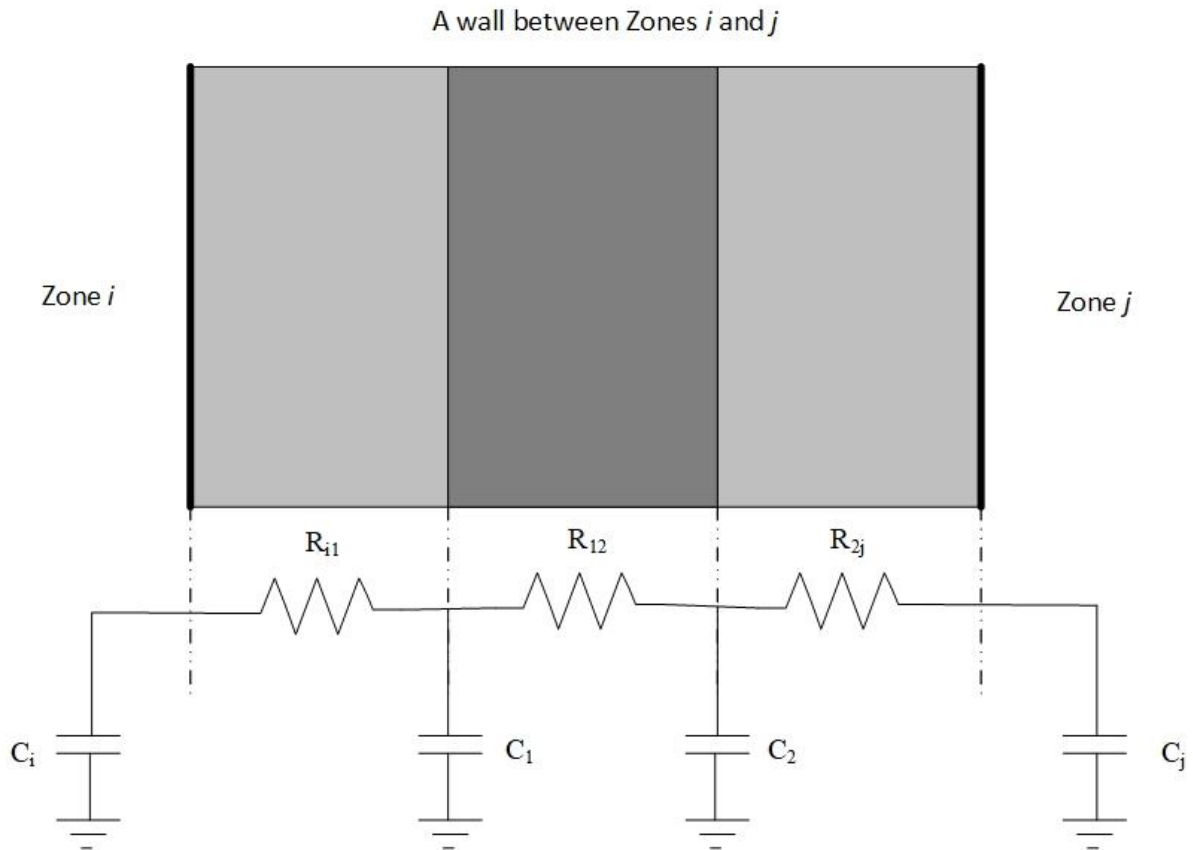

Figure 15. RC model of 2 zones [10]

2.3. Applied RC model in the simulation

After the introduction of RC models, this chapter will focus on application of RC model in the simulation, whose results will be explained later. Figure 16 shows interconnection among values, where different parameters are presented, with corresponding units:

Q – heat power [kW] R – thermal resistance [m² K/W] Θ – temperature [K] C – heat capacity [J/K]

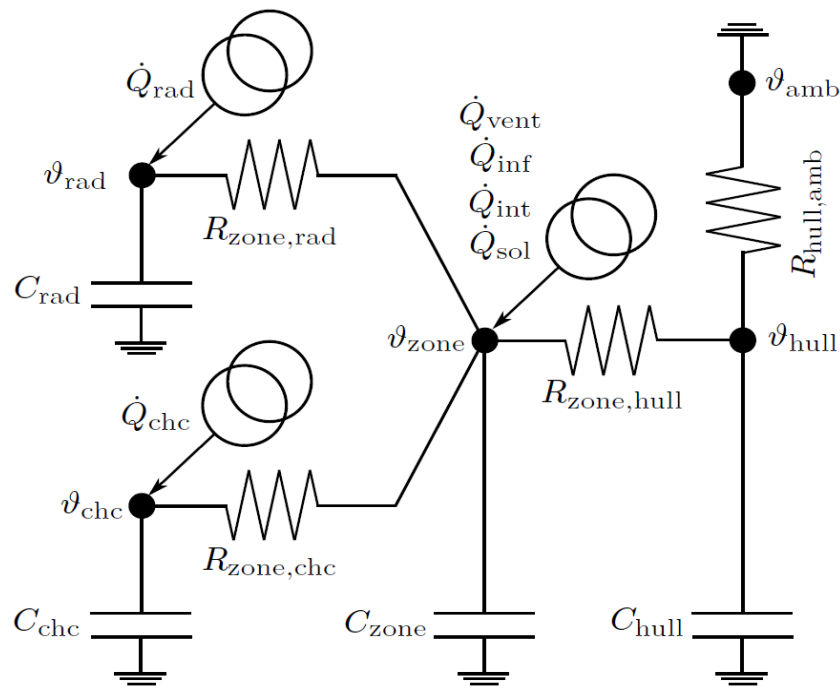

Figure 16. RC building model scheme

Inside Table 4 it is visible that values adopt different indexes, such as:

Table 4. RC variables per node

Variable	Index definition
rad	Radiator as a source/sink of heat (can be excluded)
chc	Chilled ceiling as another source/sink of heat (can be excluded)
zone	Values related to zone
hull	Sum of wall and ceiling

With majority of the presented values, mathematical model of the building can be generated inside Simulink, providing the result of the simulation in one time step, with crucial data for next simulation steps.

Mathematical modelling of the building and HVAC components will be described. A building is a complex entity whose behavior depends on a large number of entering factors. To keep the modelling calculation time acceptable, simplification of heat transfer in the zone and corresponding steps are to be explained. Final goal is to describe a general behavior of a

physical concept like building through low number of parameters and dynamic states. To understand the model, it is best to start from the 1st Law of thermodynamics and apply it on a control volume:

$$\frac{dE}{dt} = \dot{E}_{in} - \dot{E}_{out} = \sum \dot{Q} + \sum \dot{W} + \sum \dot{H} \quad (6)$$

where $\frac{dE}{dt}$ is the rate of change of the control volume's total energy E and $\dot{E}_{in} - \dot{E}_{out}$ are representing the incoming and outgoing energy flows from the control volume. The following terms $\sum \dot{Q} + \sum \dot{W} + \sum \dot{H}$ represent net heat, net work and net enthalpy crossing the control volume's boundaries. The total energy is constituted by the following terms:

$$E = E_{kin} + E_{pot} + U \quad (7)$$

where E_{kin} presents the kinetic energy, E_{pot} potential energy and U the internal energy. Assuming that first two don't change inside of the control volume ($\frac{dE_{kin}}{dt} = \frac{dE_{pot}}{dt} = 0$), only the internal energy is interesting for further application.

$$\frac{dE}{dt} = \frac{dU}{dt} = \frac{dU_{sens}}{dt} + \frac{dU_{lat}}{dt} + \frac{dU_{chem}}{dt} + \frac{dU_{nucl}}{dt} \quad (8)$$

where U_{sens} is the sensible internal energy, related to temperature, U_{lat} is the latent internal energy, related to phase changes, U_{chem} is the chemical internal energy, which accounts for the energy stored in the chemical bonds between atoms, and U_{nucl} is the nuclear component of the internal energy, which accounts for the binding forces in the nucleus. Assuming that there are no changes in the latent, chemical and nuclear components of the internal energy, and that total heat capacity C in the control volume does not change, the rate of change in the total energy can be expressed as:

$$\frac{dE}{dt} = \frac{dU_{sens}}{dt} = C \frac{d\theta}{dt} \quad (9)$$

where $\frac{d\theta}{dt}$ is the rate of change of the control volume's temperature. Thus, the rate of change of the temperature of a certain thermal node i in the modelling can be described using differential equations of the form:

$$\frac{d\theta_i}{dt} = C_i^{-1} \left(\sum_j \dot{Q}_{i,j} + \sum_m \dot{Q}_m + \sum \dot{W} + \sum \dot{H} \right) \quad (10)$$

Where the state θ_i is the temperature of node i and $\dot{Q}_{i,j}$ denotes the heat transfer between nodes i and j , with j taking the value of all nodes in thermal exchange with i . The sum $\sum_m \dot{Q}_m$ Represents the heat transfer involving node i but not caused by the interaction with other nodes in the model.

Examples include the solar gains or the heat gains caused by artificial lighting. An example for work \dot{W} is the energy supplied to a zone by a hanging fan moving the air inside it, while the air supplied to the zone by the ventilation system represents an enthalpy flow \dot{H} . In this case, it is assumed that in the building zone $\sum \dot{W} = 0$ at all times, i.e. there is no work applied inside the control volume. It must be noted that assuming homogeneous thermal nodes implies that the contents of each control volume are well-mixed, therefore the temperature of a fluid leaving a node is equal to the node temperature ($\theta_r = \theta_i$):

$$\frac{d\theta_i}{dt} = C_i^{-1} [\dot{m}(\theta_s - \theta_r) + \dots] = C_i^{-1} [\dot{m}(\theta_s - \theta_i) + \dots] \quad (11)$$

where \dot{m} is the mass flow entering and exiting the node, θ_s is the supply temperature and θ_r is the return temperature, as visible in the Figure 17.

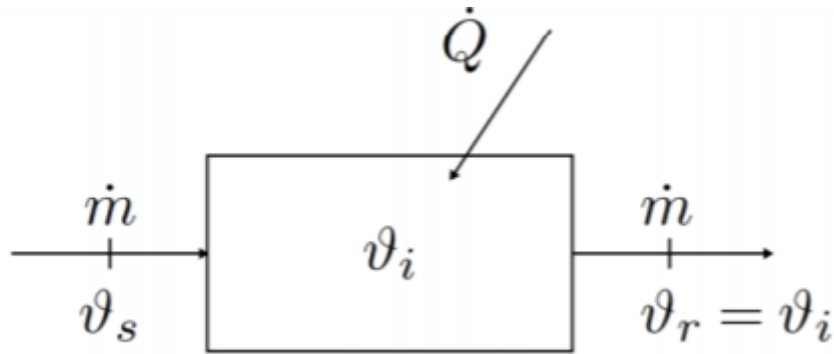

Figure 17. Zero-dimensional model

In general, the heat transfer processes and the enthalpy flows in a building lead to differential equations that are nonlinear in the nature. Through the linearization of the heat transfer between the nodes, the complexity of the system's governing equations can be greatly reduced, leading to bilinear models. The bi-linearity that is present in the equations is of the form:

$$\frac{d\theta_i}{dt} = C_i^{-1} [\dot{m}(\theta_{supply} - \theta_i) + \dots] \quad (12)$$

Where the multiplication between the mass flow \dot{m} (an input) with the temperature θ_i (a state) is a bilinearity. This bi-linearity appears whenever a mass flow exchanges heat with the node, such as in the radiators, chilled ceilings and ventilation air. However, if during a certain period of time the mass flow \dot{m} is kept constant, the system's behavior can be modeled as being linear during that period. In this study, it is assumed that all the system's inputs are constant during a period of $\Delta t_s = 15$ min. This allows fast evaluation times, because algebraic methods can be employed to solve the system of linear equations instead of the numerical solving required by the differential equations.

To summarize the equations, they are presented as differential equations modelling the building. The differential equations that define the behavior of the office building are as follows:

$$\begin{aligned} \frac{d\theta_{zone}}{dt} = C_{zone}^{-1} [& \dot{Q}_{zone,hull} + \dot{Q}_{zone,rad} + \dot{Q}_{zone,cbc} + \dot{Q}_{vent} \\ & + \dot{Q}_{inf} + \dot{Q}_{int} + \dot{Q}_{sol} \dots] \end{aligned} \quad (13)$$

$$\frac{d\theta_{hull}}{dt} = C_{hull}^{-1} [\dot{Q}_{hull,amb} - \dot{Q}_{zone,hull}] \quad (14)$$

$$\frac{d\theta_{rad}}{dt} = C_{rad}^{-1} [-\dot{Q}_{zone,rad} + \dot{Q}_{rad}] \quad (15)$$

$$\frac{d\theta_{chc}}{dt} = C_{chc}^{-1} [-\dot{Q}_{zone,chc} + \dot{Q}_{chc}] \quad (16)$$

with the heat flows between nodes being defined as:

$$\dot{Q}_{zone,hull} = R_{zone,hull}^{-1} [\theta_{hull} - \theta_{zone}] \quad (17)$$

$$\dot{Q}_{zone,rad} = R_{zone,rad}^{-1} [\theta_{rad} - \theta_{zone}] \quad (18)$$

$$\dot{Q}_{zone,chc} = R_{zone,chc}^{-1} [\theta_{chc} - \theta_{zone}] \quad (19)$$

$$\dot{Q}_{hull,amb} = R_{hull,amb}^{-1} [\theta_{amb} - \theta_{hull}] \quad (20)$$

The enthalpy flows (simplified as heat flows) are defined as:

$$\dot{Q}_{vent} = \dot{m}_{vent} [\theta_{vent,s} - \theta_{zone}] \quad (21)$$

$$\dot{Q}_{rad} = \dot{m}_{rad} [\theta_{rad,s} - \theta_{rad}] \quad (22)$$

$$\dot{Q}_{chc} = \dot{m}_{chc} [\theta_{chc,s} - \theta_{chc}] \quad (23)$$

$$\dot{Q}_{inf} = \dot{m}_{inf} [\theta_{amb} - \theta_{zone}] \quad (24)$$

It is assumed that the pressure in the building is equal to the ambient pressure and that the passive infiltration mass flow m_{inf} is equal to the exfiltration mass flow.

The internal gains, separated in occupant \dot{Q}_{occ} , equipment \dot{Q}_{eq} and lighting gains \dot{Q}_{light} , are defined as:

$$\dot{Q}_{int} = \dot{Q}_{occ} + \dot{Q}_{eq} + \dot{Q}_{light} \quad (25)$$

All mentioned equations are derivation of 1st law of thermodynamics, while heating/cooling load is calculated internally under DIN 12831 norm. [13]

2.4. Heating/cooling principles

Apart from 1st Law of thermodynamics that was mentioned in Applied RC model in the simulation, 2nd Law of thermodynamics says that the heat goes naturally from the body at higher temperature to the body at lower temperature. That law is the axiom in the field of thermodynamics and cannot be denied. Only systems that, from the first sight look like trying to do that, are devices working on the principles of left cycled process, known as refrigerators and heat pumps (Figure 18).

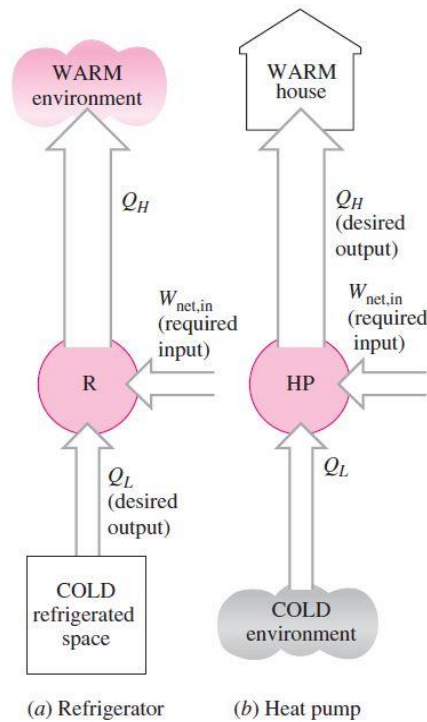

Figure 18. Basic difference between refrigerator and heat pump [14]

Difference between refrigerators and heat pumps, according to [14] are their usage and objective, but in principle they are the same, which means that heat pumps can be used in both cooling and heating mode.

Q_L is the magnitude of the heat removed from the refrigerated space at the temperature T_L while Q_H is the magnitude of heat transferred back to the environment. W_{in} represents the net work input by compressor to the cycle. Simplified cycle shown in the Figure 19, can be separated into four processes:

- 1-2 Isentropic compression in a compressor
- 2-3 Constant-pressure heat rejection in a condenser
- 3-4 Throttling in an expansion device
- 4-1 Constant-pressure heat absorption in an evaporator

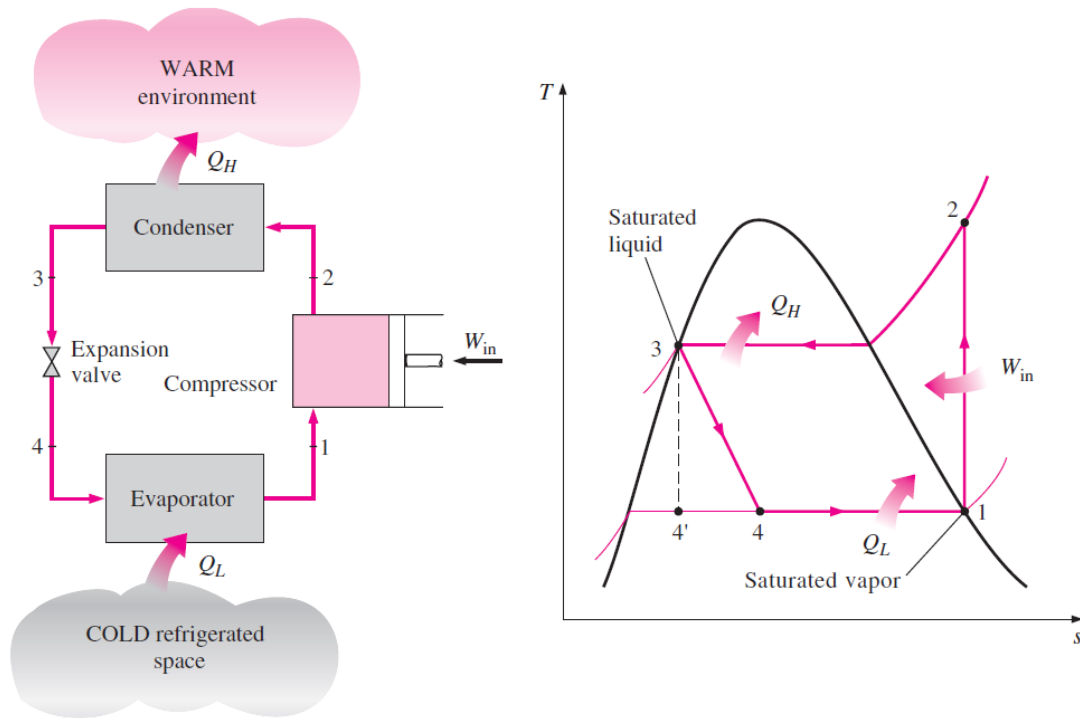

Figure 19. Scheme and T-s diagram of ideal vapor-compression refrigeration cycle [14]

Since the heat transfer description of IDUs and ODU's are crucial for the simulation, basic explanation of the heat transfer through the tube will be explained.

Let us imagine a section of pipe shown in the Figure 20 with corresponding fluids. Fluid "a" is often representing refrigeration fluid inside the tube, while on the other side fluid "b" is air.

Basic heat flow equation in this case is: [15]

$$\Phi = k * A * (\theta_{00a} - \theta_{00b}) \quad (26)$$

where A [m^2] represent the surface of heat transfer, k [W/m^2K] heat transfer coefficient and θ temperatures. Surface of the tube can be generally expressed like $A(x) = 2 * r(x) * \pi * L$. Heat flow for one layered tube is presented by the equation:

$$\Phi = \frac{\theta_{\infty a} - \theta_{s1}}{\frac{1}{2R_1\pi L \alpha_a}} = \frac{\theta_{s1} - \theta_{s2}}{\frac{1}{2\pi L \lambda \ln \frac{R_2}{R_1}}} = \frac{\theta_{s2} - \theta_{\infty b}}{\frac{1}{2R_2\pi L \alpha_b}} \quad (27)$$

where R_1 [m] presents radius of the tube, θ_{00a} [$^{\circ}C$] temperature of fluid "a", θ_{00b} temperature of fluid "b", L [m] length of tube, α_a [W/m^2K] convective coefficient of heat transfer of fluid

“a” and λ thermal conductivity of tube's material. The overall heat transfer coefficient can be derived on inner side of the tube:

$$k_1 = \frac{1}{\frac{1}{\alpha_a} + \frac{R_1}{\lambda} \ln \frac{R_2}{R_1} + \frac{R_1}{R_2 \alpha_b}} \quad (28)$$

This equation shows general calculation of heat transfer coefficient in tube application, used as a base example to explain heat transfer coefficients for IDU and ODU simplification of this simulation. In comparison to regular heat transfer coefficient that has an analytical relation. In the thesis relations of Shah (1979) [16] [17] and Gungor&Winterton (1986) [18] for both evaporation and condensation are used. They used derivations of experimental relations in order to estimate evaporation and condensation heat transfer coefficients in tubes of ODU and IDU. They have calculated it for different refrigerants, but relations for R410A will be taken into consideration since the real system used for validation of Simulink models of IDU and ODU used R410A. [19]

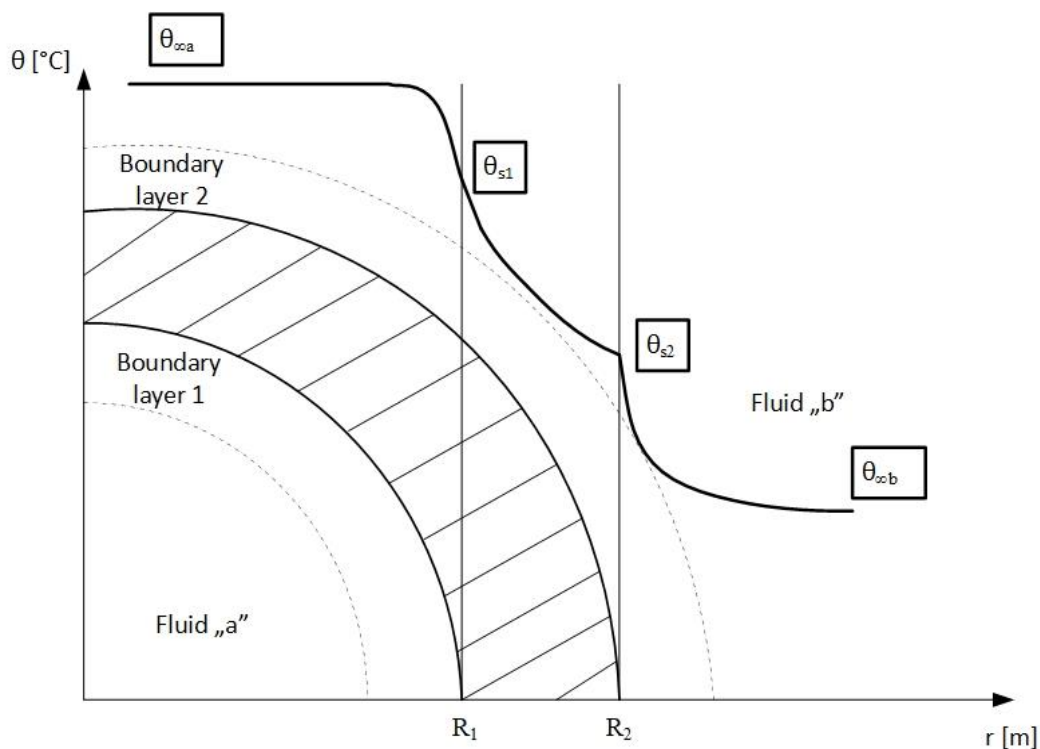

Figure 20. Heat transfer through pipe

Gungor and Winterton suggested an empirical correlation of Nusselt number for boiling flow, then modified and suggested a simpler correlation:

$$h_{ref} = h_{liq}(1 + 3000 * Bo^{0,86} + 1,12F) \quad (29)$$

where h_{liq} is expressed in [W/m²K].

If $Re < 2300$, then:

$$h_{liq} = \frac{k_{liq}}{d} * 0,023 * Re^{0,8} * Pr_{liq}^{\frac{1}{3}} \quad (30)$$

where k_{liq} is expressed in [W/m K] and it presents thermal conductivity of a liquid.

Or $Re > 2300$

$$h_{liq} = \frac{\frac{k_{liq}}{d} * \frac{f}{2} * (Re - 1000) Pr_{liq}}{1 + 12,7 * \frac{f^{0,5}}{2} * (Pr_{liq}^{\frac{2}{3}} - 1)} \quad (31)$$

where two last equations depend on Re number that is a dimensionless number to define type of flow, either laminar or turbulent.

$$f = (1,58 * \log(Re) - 3,28)^{-2} \quad (32)$$

Bond number (Bo), measures the importance of gravitational forces compared to surface tension forces. It is used to characterize the shape of bubbles or drops moving in a surrounding fluid. It is calculated:

$$Bo = h_{air} * \frac{T_{air} - T_{ref}}{G_{ref} - \Delta h} = Nu_{air} * \frac{k_{air}}{d} * \frac{T_{air} - T_{ref}}{G_{ref} - \Delta h} \quad (33)$$

Where F accounts for:

$$F = \left(\frac{x}{1-x}\right)^{0,75} * \left(\frac{\rho_{liq}}{\rho_{vap}}\right)^{0,41} \quad (34)$$

On the other side, to define condensation heat transfer coefficient, Shah's relation is being used:

$$h_{ref} = \frac{k_{liq}}{d} * Nu_{liq} * [(1-x)^{0,8} + (3,8 * x^{0,75} * (1-x)^{0,4} / p_{ratio})] \quad (35)$$

where x represents steam quality, $\rho_{liq/vap}$ corresponding density and p_{ratio} ratio of critical pressure and saturation pressure.

$$Nu_{liq} = 0,023 * Re^{0,8} * Pr_{liq}^{0,4} \quad (36)$$

2.4.1. Refrigerants

Media used inside closed loops of the heat pumps are called refrigerants, which are chemical substances or mixtures, undergoing a phase change inside heat pumps. They were massively used starting from 20th century in all house refrigerators and air conditioners, without paying much attention to their impact on the nature, more specifically, on ozone layer. In 1995 a group of scientists (*Paul J. Crutzen, Mario J. Molina and F. Sherwood Rowland*) proved that refrigerants defect ozone layer and won Nobel's prize in field of chemistry. [20] From that moment onwards, many scientists, engineers and politicians [21] are putting more emphasis on refrigerant's influence on ozone. As a consequence, many new refrigerant mixtures that are now present on market, have no or least possible influence on ozone depletion. In order to measure that impact, so called ODP or Ozone Depletion Potential was introduced. In parallel to further green actions and taking more care about our environment, another parameter came to light, GWP or Global Warming Potential. It explains the potential of the refrigerant to warm up the atmosphere in comparison to CO₂, which is used as a reference. List of commonly used refrigerants inside heat pumps are listed in Table 5:

Table 5. Different properties of commonly used refrigerants [22]

Property	R22	R404a	R410a	R407C	R717
ODP	0,055	0	0	0	0
GWP ₁₀₀	1500	3260	1725	1526	0
Molecular mass	86,47	97,6	72,59	86,2	17,03
Critical temperature, °C	96,2	72,14	70,17	86,05	135,25
Critical pressure, bar	49,9	37,4	47,7	46,3	113,3
Boiling temperature at 1 bar, °C	-40,8	-46,6	-51,6	-43,8	-33,33
Temperature slip, °C	0	0,5	0,1	5-7	0
Boiling pressure (-15 °C), bar	2,96	3,72	4,82	3,39/2,64	2,36
Liquid density (30 °C), kg/m ³	1171	1021	1035	1116	595,2
Steam density (-15 °C), kg/m ³	12,9	18,57	18,43	11,48	1,97
Specific evaporation heat (-15 °C), kJ/kg	216,5	177,7	237,6	221,9	1312,8
Volumetric cooling effect, kJ/m ³	2178,8	2250,7	3243,7	1888,5	2214,3

In further work, all equations will be taken for refrigerant R410A because of its high volumetric cooling effect, average critical pressure, average GWP and accessible price. Future decisions of primarily EU representatives are leading us to reducing the usage of R410A and switch to less pollutable refrigerant like R32. It has higher efficiency and it is easier to recycle since it is a single component refrigerant, in comparison to R410A that is a mixture of substances. [23]

2.4.2. Heat pumps

2nd law of thermodynamics says that the heat can be transferred from objects of higher to objects of lower temperature naturally, with no usage of external sources of energy or any man made devices. Opposite process of transferring heat from colder object to hotter one is still possible by usage of additional net work, usually compressor that consumes electrical energy. [14]

Main benefit of heat pumps in comparison to regular heating systems is the possibility to use them in both cooling and heating mode, which is possible by using electro mechanical 4 way

valve that reverses flow of refrigerant, shown in the Figure 21. That way IDU turns from condenser to evaporator and ODU from evaporator to condenser. The example of converting the working mode from heating to cooling is shown in the Figure 22 and Figure 23. In these Figures it is important to distinguish that the left heat exchanger coil is an outdoor coil in environment, while the right one is an indoor one.

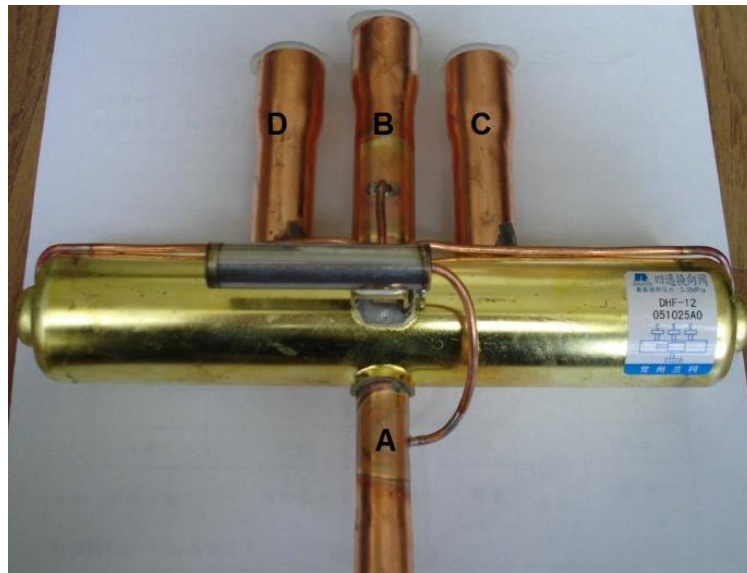

Figure 21. Four-way valve [24]

In order to understand 4 way valve principle of work, explanation of components and their corresponding number are in the Figure 22, Figure 23 and Table 6:

Table 6. Four-way valve components [24]

Component number	Description
1	Capillary tube D
2	Capillary tube A
3	Capillary tube C
4	Slider
5	Block
6	Electrical coil
7	Electrical magnet
8	Spring

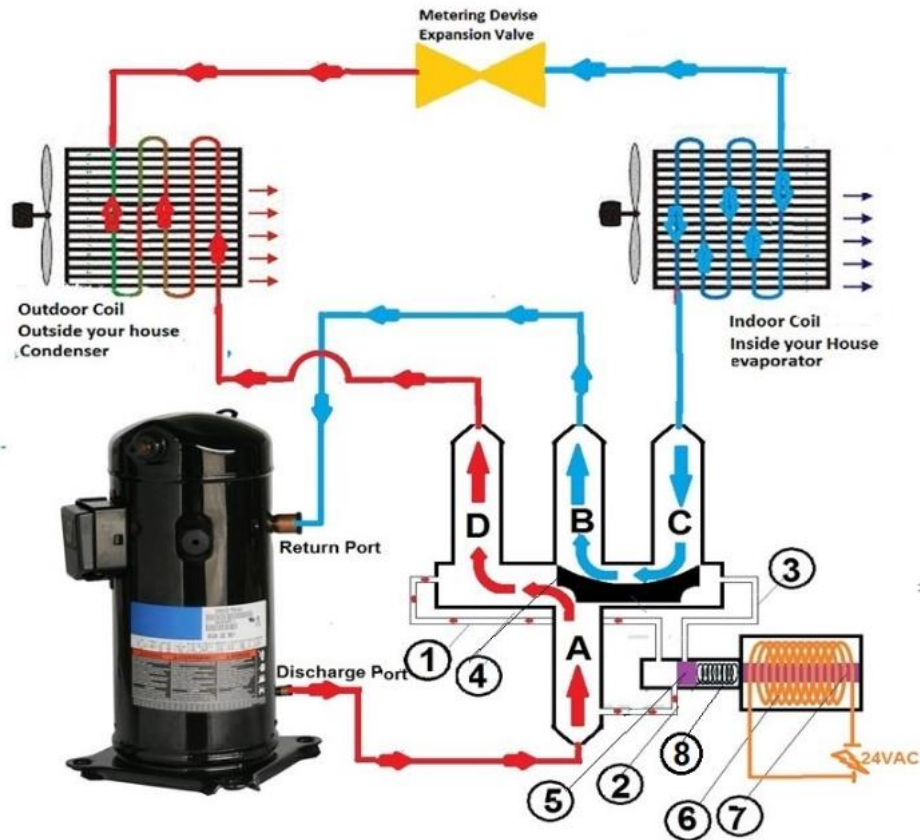

Figure 22. Four-way valve in position for cooling [24]

As shown in the Figure 22, compressor's discharge port (high pressure) is always connected to tube A in the reversing valve and the return port (low pressure) in the compressor is always connected to tube B. Therefore tube A always has higher pressure refrigerant, and tube B always has lower pressure refrigerant. Capillary tube is always connected to tube A, and because of that it also has a high pressure. When the electrical coil gets aroused, it arouses the magnet that pulls the block which will block the capillary tube and compresses the spring.

Since the capillary tube C is now blocked, and the high pressure refrigerant will flow from capillary A to capillary D straight to the left side of the heat pump, reversing valve's body that will push the slider to right hand side from the valve's body which will allow the high pressure refrigerant to go from the tube A to tube D and then to the outdoor coil, through the metering device to drop its pressure, then to the indoor coil to cool the inside of the house, then back to tube C .

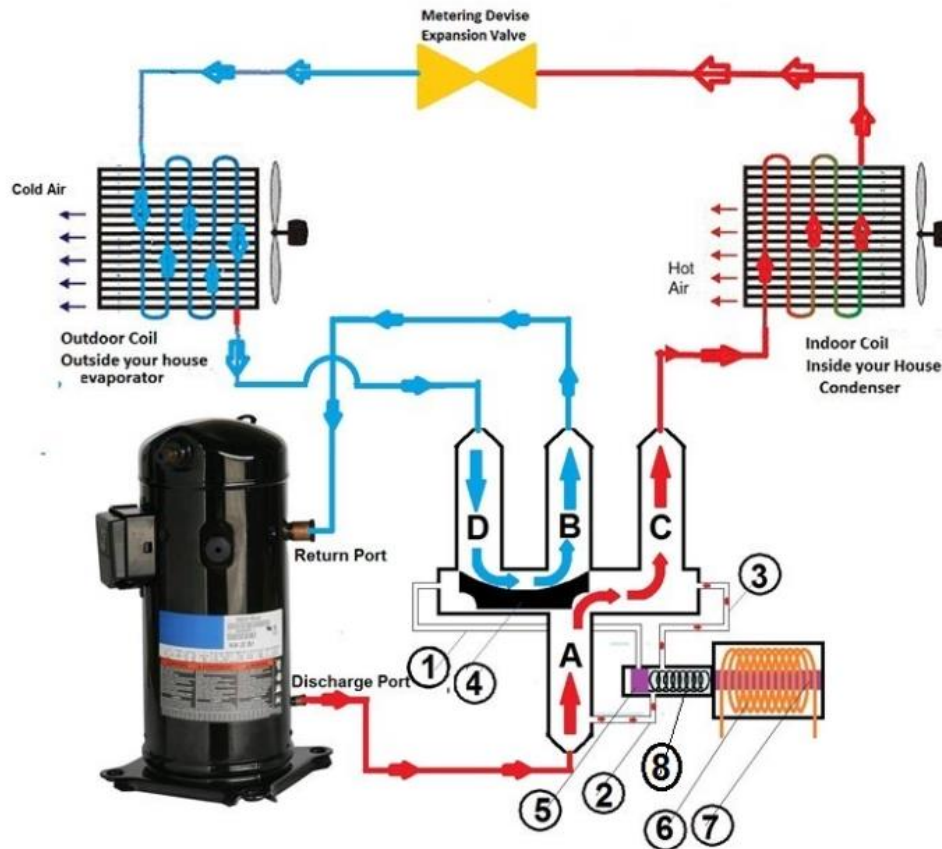

Figure 23. Four-way valve in position for heating [24]

In comparison to cooling, during the heating the coil lost its power, or de-activated, which makes the electrical magnet lose its magnetic power. When this occurs, the spring will decompress and push the block to the left, and block the capillary tube D. The capillary tube D is now blocked and the high pressure refrigerant will flow from capillary A to capillary C straight to the right side from the reversing valve's body. This in turn will push the slider to the left hand side of the valve's body, which will allow the high pressure refrigerant to go from the tube A to tube C. This allows refrigerant to flow to the indoor coil to heat the inside of the house (heating mode in Figure 23), then through the metering device to drop its pressure, then to the outdoor coil and back to tube D.

To validate the ratio between taken heat from the system and invested net work, there are two coefficients in use, so called:

- COP (Coefficient of Performance)
- EER (Energy Efficiency Rating)

And theoretical values of COP and EER can be calculated, referring to the Figure 18 (the one showing heat pump and refrigerator) as:

$$COP = \frac{\text{Heating effect}}{\text{Work input}} = \frac{Q_H}{W_{net}} = \frac{Q_L + W_{net}}{W_{net}} \quad (37)$$

$$EER = \frac{\text{Cooling effect}}{\text{Work input}} = \frac{Q_L}{W_{net}} \quad (38)$$

The higher are both parameters, the more energy efficient are the systems. Efficiencies of the systems depend on the heat source and heat sink temperatures of “heat storages”, which can be separated into four categories. Due to that, there are different combinations of heat pumps, having these heat storages:

- Air
- Ground
- Water
- Sea.

Each one of these “heat storages” have different mean annual temperatures that allow them to be used in different applications and various regions, depending on the requirements set from the investor/buyer. Due to that, there are have combinations such as air-air, air-water, ground-water and ground-air.

2.4.3. Basic models used in Simulation library

Following all mentioned heat transfer physical basics used in chapter above, there are two experimental relations that approximate condensation and evaporation heat coefficients of IDU:

- Shah for heating (condenser)
- Gungor and Winterton for cooling (evaporator).

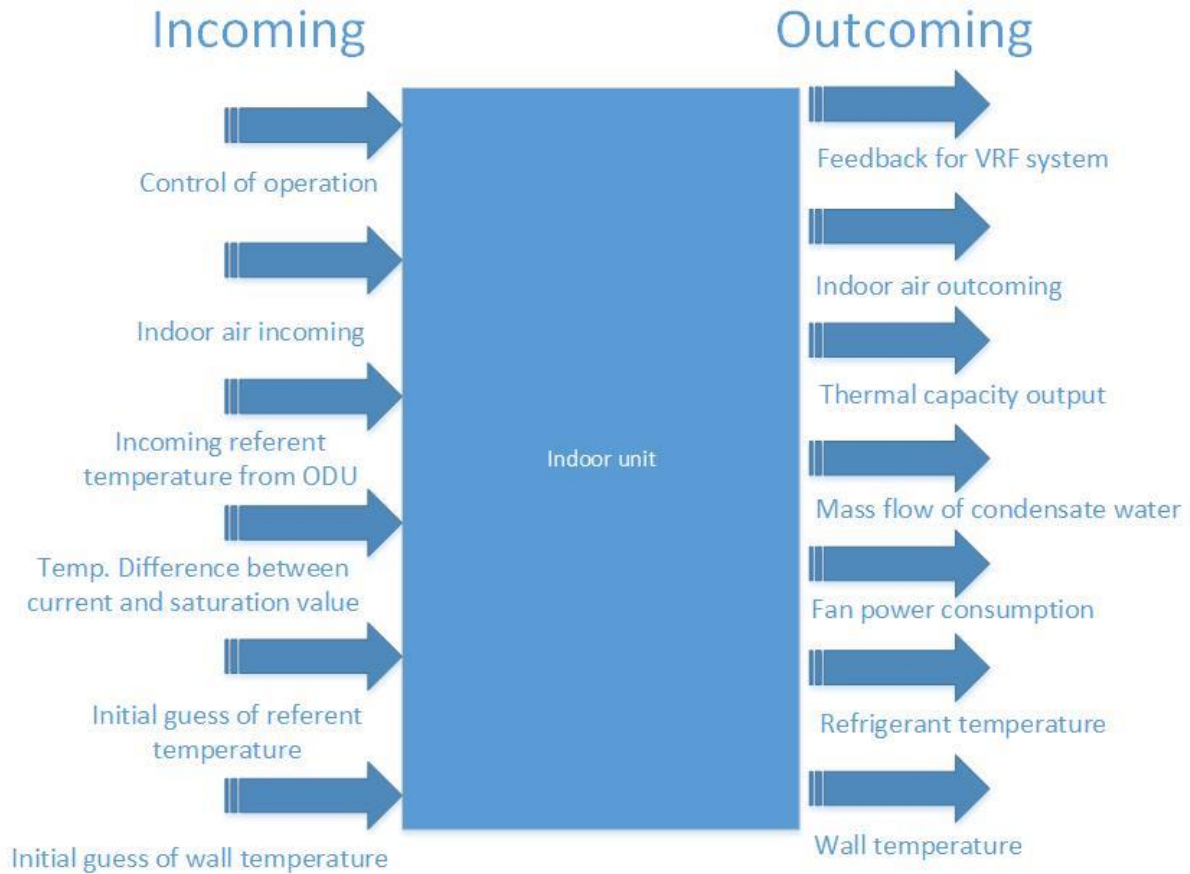

Figure 24. Simulation scheme of IDU

In Simulink, model of indoor unit is created with all under-mentioned signals, which can be easily seen in the Figure 24. These signal are representation of real values coming in the IDU model. Running a simulation provides a sourceful data from the simulation.

Input parameters:

- Control for IDU operation
- Indoor air incoming bus
- Incoming referent temperature from ODU
- Temperature difference between current and saturation value
- Initial guess of referent temperature
- Initial guess of wall temperature.

Output parameters:

- Feedback bus for VRF system

- Indoor air outcoming bus
- Thermal capacity output
- Mass flow of condensate water
- Fan power consumption
- Refrigerant temperature
- Wall temperature.

Aside from listed values, there are other ones that get loaded with IDU selection like coil length, height, tube diameter, fan power, piping length etc.

All these parameters create really good representation of the unit in a simulation, increasing representability of the simulation of VRF system. ODU model is created in a very similar way and presenting its signals won't be showed here as a part of the thesis.

2.5. VRF system

Variable Refrigerant Flow (VRF) was developed in 1982 by Daikin Industries as a new concept to optimize big HVAC systems. This system uses refrigerant, which is conditioned by either single or multiple ODUs and is circulated to multiple indoor units (Figure 25).

VRF uses a DC inverter for the compressor in order to support variable motor speed and consequently vary the flow of the refrigerant, that way securing always needed refrigerant flow. That leads to big energy savings, high efficiency, low sound generation and increasing the thermal comfort by individually defining a room temperature. In comparison to natural gas condensation boilers, there is no risk of CO poisoning and no need to build an exhaust chimney. Nevertheless, easy change of broken IDU is a great benefit, with no need to stop whole running system. Modularity is what makes VRF attractive, with option to extend number of ODUs in case that all floors in the big commercial building get rented/sold/used.

On the other hand, VRF system needs long piping, which can cause issues in case of leakage, which cannot be easily determined. Long piping and vertical difference put a lot of stress on projecting a proper sized compressor to be able to master local and line losses.

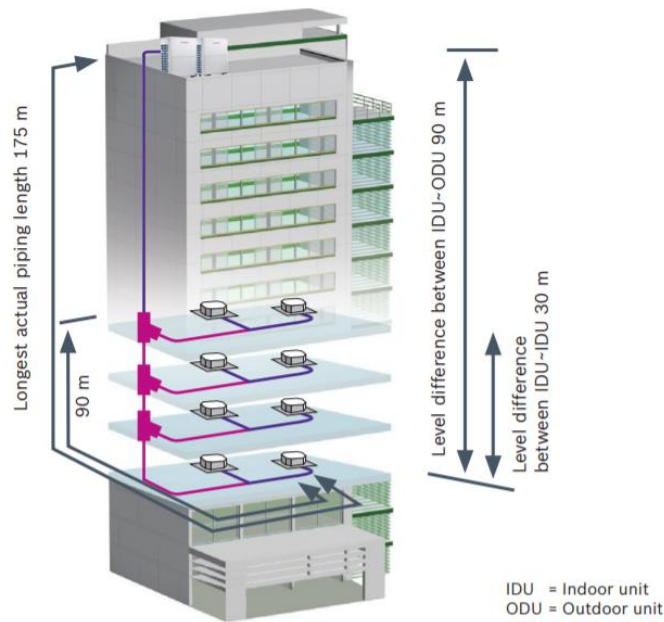

Figure 25. Commercial VRF scheme [25]

There are two basic types of VRF systems, one is heat pump, and another is heat recovery. Heat pump uses already known and mentioned principles in chapter 2.4, but heat recovery introduces a possibility to separately heat and cool at the same time, while converting heat from cooled zone and compressing it to higher temperature level and transmitting it to heated zone. That way energy consumption is reduced, while coefficient of heating (COP) and cooling (EER) are increased. [26]

As seen in the Figure 26, simplified configuration of VRF has basic cooling cycle components. List of corresponding parts of configuration can be seen in next Table 7:

Table 7. VRF scheme explanation

Component scheme number	Explanation
1	Compressor
2	Discharge temperature switch
3	High pressure switch
4	High pressure sensor
5	Oil separator

6	Four-way valve
7	Heat exchanger
8	Electronic expansion valve
9	Low pressure switch
10	Fan motor
11	Fan
12	Stop valve (liquid side)
13	Stop valve (gas side)
14	Refrigerant accumulator
-----	High pressure, high temperature gas
-----	High pressure, high temperature liquid
-----	Low pressure, low temperature

Refrigeration and air conditioning compressors are vapor compressors, meaning they are designed to compress refrigerant vapor, not liquid refrigerant. Liquids cannot be compressed, which is why keeping liquid refrigerant away from compressor is the biggest challenge in control of the cycle. Due to that, refrigerant needs to get superheated and to avoid refrigerant's drops. The compressor is often referred to as the heart of the refrigeration system. Without the compressor, refrigerant could not reach other system components to perform its heat transfer functions.

Serious mechanical damage will occur to the compressor's valve structure and drive train when liquid refrigerant enters the compressor's cylinders or end bell. If the liquid refrigerant doesn't do direct damage to the valve structures, it will do indirect damage to the internal drive components of the compressor when it dilutes the crankcase's oil and degrades its lubricity. [27]

Discharge temperature switch (2), high pressure switch (3) and high pressure sensor (4) are all considered as safety components of the cycle, turning on or off the compressor and stopping the cycle progress in the case of emergency or unexpected process values.

In oil separator (5), oil steam is being separated from the liquid and proceeded to four-way valve (6), component that was explained in chapter 2.4.2. Condenser (7) follows as a next part

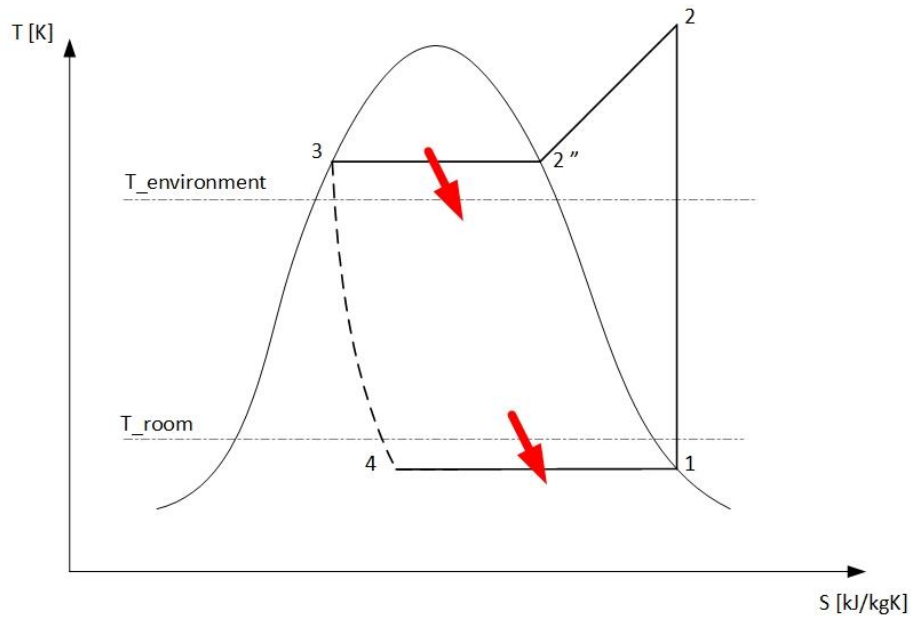

Figure 27. T-s diagram of cooling

On the other side, heating cycle changes four-way valve to appropriate position and switches the evaporator to condenser and vice versa. All corresponding points of the cycle can be defined in T-s diagram as well, what can be seen in the Figure 29.

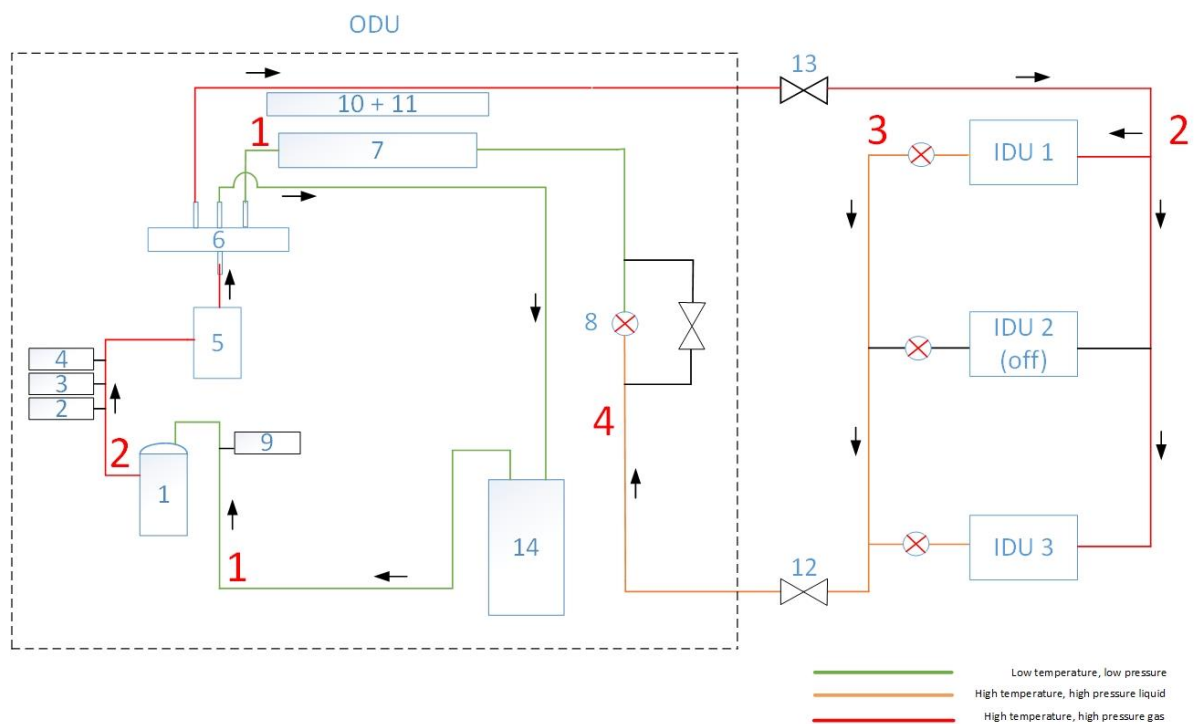

Figure 28. VRF scheme with 3 IDUs and 1 ODU (heating mode)

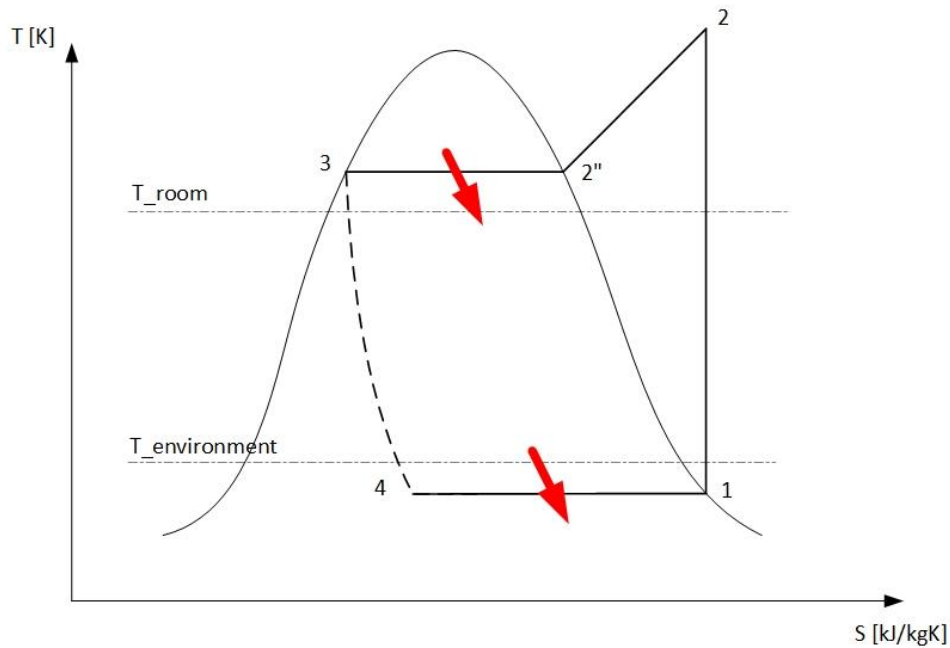

Figure 29. T-s diagram of heating

2.5.1. Communication among VRF devices

Serial communication is increasingly being used in many communication applications. Basic example would be USB (Universal Serial Bus), which is becoming a worldwide standard for data transfer, charging the phones and any kind of gadgets. It uses ones and zeroes, with strictly defined starting and ending patterns in order to generate senseful messages that can be easily read by devices. Parallel communication gives possibility to increase the speed of data transfer, but this increase has its downside (Figure 30). It is in a process of abandoning after years of development as a communication standard, due to difficulties with interference and communication noise.

Due to that, communication protocol in VRF system uses serial communication as a standard to make it simpler and more standardized.

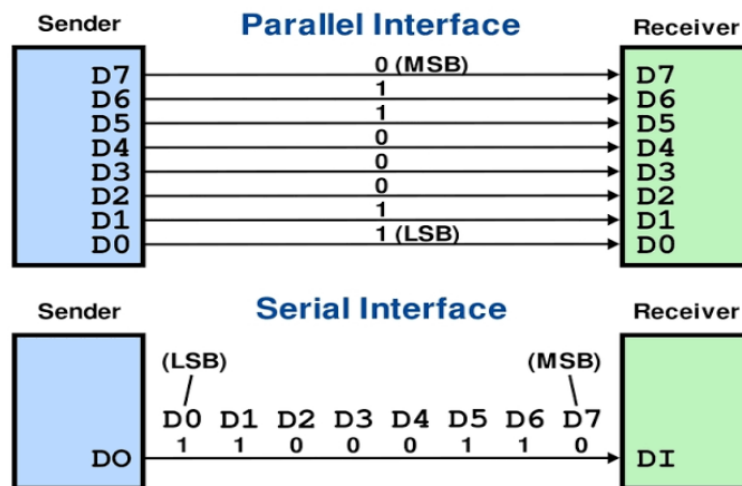

Figure 30. Parallel and serial communication interface [28]

Serial protocol functions as constant polling from controller devices for a status of IDUs and ODUs, all with their corresponding addresses. Polling, is in fact, a set of strings of hexadecimal byte couples that can be easily translated into binary bits that represent some valid functions of the system. Under different bytes, e.g. byte 13 has a value of mode setting or byte 24 that has a set temperature byte, real values of the system are stored in binary value. Although strings look similar at the beginning and at the end, core data being sent is the most important part of the string. The beginning and the end are having standardized values in order to distinguish different messages from each other.

For example value “37” in hexadecimal number system is presenting “0011 0111” value in binary number system, that way allowing storage of a lot of different messages under one hexadecimal byte value.

With the usage of serial communication, data exchange between the CC and local server (over the client) is established. CC is a device being able to read strings of proper length that are predefined by VRF protocol. Length of the string is different from command to command and explained in the protocol. In case the length is shorter or longer, CC cannot understand the communication. This means client used for this communication channel should be carefully configured accordingly to protocol standards.

3. Implementation

In this section all the differences in comparison to the current state of the art will be explained, including graphs, building configurations and simplifications.

3.1. Comparison with the current state of the art

Current state of the art is good enough to simulate robust systems that are detailed in gathering all possible data from the communication protocol and simulation. In comparison to that, what we need is a fast, an easy to simulate and configure system that should give us basic parameters from the system, fetch that data from it and store it on a local server to run Hardware-in-the-Loop test.

Some values that were decelerating the simulation were commented out and are serving just to show the possibilities of the system, e.g. flow of condensate from IDUs and calculation of the air density at every time step.

New approach of RC building is being used in comparison to older TRNYSIS model of building which had a limited number of heating/cooling zones, leading to less flexibility with number of IDUs and optimization of the space temperature.

To make simulation faster, internal feature of MATLAB was used called *parsim₂*, which evenly distributes the load of simulation on all cores of the computer's processor. [29] Similar approach is done with IDUs and ODUs, more accurately with internal switching logics of the zones and refrigeration systems related to ODUs. Load of the zone is evenly distributed among IDUs which gives no reason to make comparison of IDUs inside one zone, because they all have the same set temperature of 23°C. Nevertheless, ODUs have less flexibility and are functioning in a cascade mode, running only one ODU at the beginning. Once it reaches higher load limit, it switches next ODU that takes partially the load of the first one.

In order to successfully run real time application of the controller, there were few improvements on the side of the simulation to be implemented. There is a pause command every 20 seconds to check and update the values on the local server, if there were any changes on the simulation. Another implemented case triggering pause is a change of value on the local server, triggered by CC. This way the reading client (better explained in chapter Architecture

of the new test bed), observes the change of the value and triggers the writing client, in parallel pausing the simulation on few seconds.

3.2. Reference system

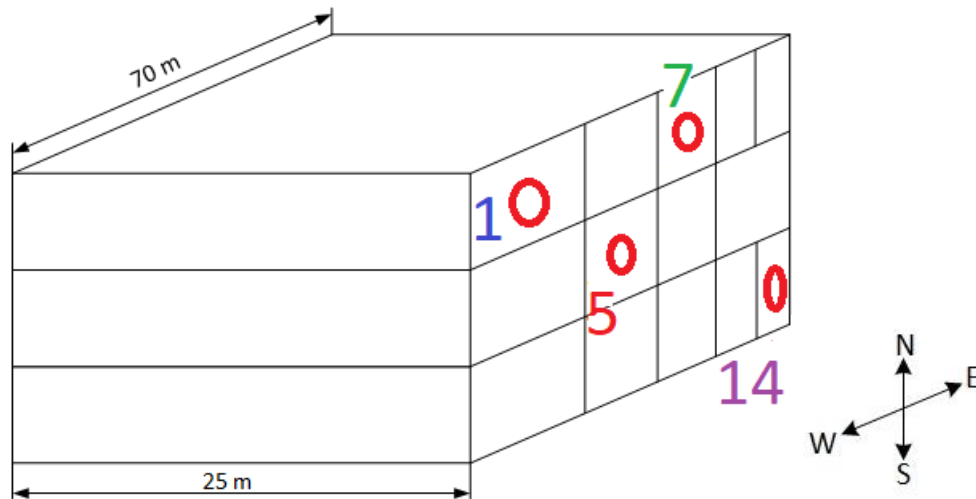

Figure 31. Selected zones of the building

Building model and selection of the zones are shown in the Figure 12 with corresponding results in following chapters, while selection of building materials in chapter 2.1.1.

The focus in further comparison of data will be done in these 4 points, and following the color patterns, number 1 is equal to blue, number 5 to red and so on (also marked in IDU distribution table such as Table 10). These colors will be standard for showing different results of multi-zonal building.

RC building incoming parameters for zone 1, are shown in Table 8:

Table 8. Example of incoming RC building parameters

Parameter	Unit	Value
Air infiltration rate	h^{-1}	4
Thermal resistance hull to room	$\text{K m}^2/\text{W}$	0.3
Thermal resistance ambient to hull	$\text{K m}^2/\text{W}$	1.5

Thermal resistance wall to zone	K m ² /W	1.4
Capacity hull	J/K	70 000 000
Capacity zone	J/K	6 500 000
Capacity wall	J/K	115 000 000
Zone volume	m ³	2700
Façade area (windows + outer walls)	m ²	400
Wall reflection	-	0,4
Internal wall area	m ²	135
Roof area	m ²	750
Window wall ratio of orientation (North, East, South, West)	[0 - 1]	[1 0 1 0]
Wall ratio of orientation (North, East, South, West)	Sum equals 1	[0,333 0,166 0,333 0,166]
Surface shadowing (North, East, South, West, Roof)	[0 - 1]	[0,2 0,4 0,5 0,2 1]
Inclination	[-90 to 90]	[0 0 0 0]
Surrounding albedo	[0 - 1]	0,2

All incoming parameters can be changed, adapting the values on corresponding side of the world orientation, size of the heating/cooling zone, inclination of the window and wall reflection coefficient. Two most important incoming parameters for RC building, thermal resistance and capacity of the different “building bricks” of a single zone are as shown in the Figure 32.

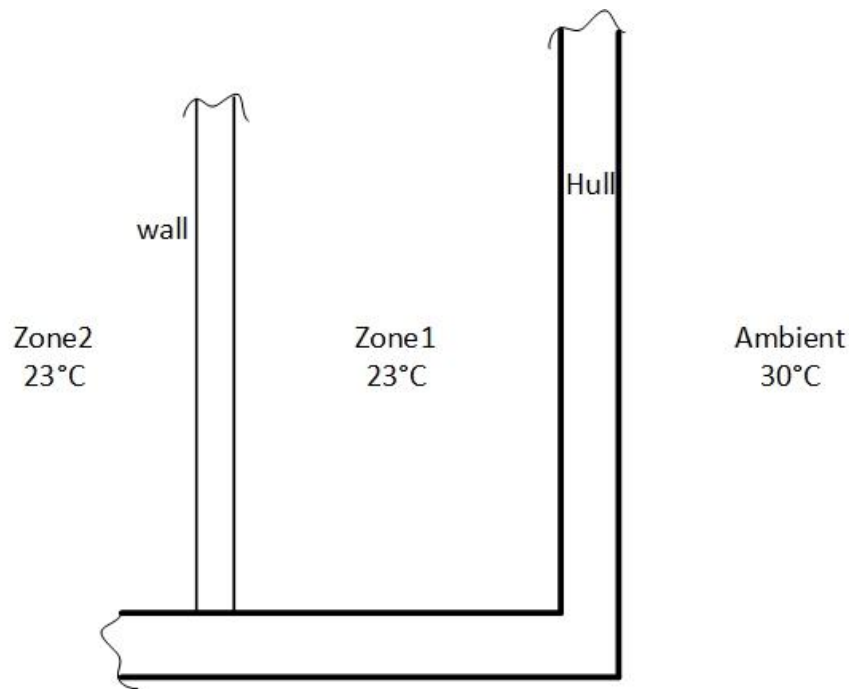

Figure 32. Definition of wall, hull and ambient

3.3. Architecture of the new test bed

Local server is a server used for storing the values from the both CC and simulation with their corresponding values. Defining the correct and same name of the signal has to be preconfigured in both clients, one connecting the simulation with local server and another one connecting CC with local server. Baud rate has to be correctly defined in communication patterns and same for all members of communication chain, otherwise values will be seen on, so called communication sniffing tools such as HTerm, as some unreadable values.

One of the challenges of the clients was storing digital data in a manner that all members of the communication chain could understand value stored from e.g. CC on the local server. This is where three possible approaches to communication chain in between CC and simulation have been proposed:

- Local server with his already built-in clients
- Python server + Python clients

- Local server with newly developed python client

First approach was easy to test but didn't show correct values and it faced timing issue coupled with no simplicity in a debugging process of an already existing platform.

Second approach seemed to be more feasible if the simulation was conducted inside MATLAB only, because client for connecting from local server to Simulink wasn't existing at a time.

The last one is the approach that was taken in this thesis, due to its already existing local server and client to Simulink, but communication towards CC had to be improved. Selection of this approach was also confirmed due to final goals of running automated test cases against the controller, written and executed in Python.

At the current development stage, client from CC to local server is not easily upgradeable and would provide the fixed answer values for different commands, making it hardcoded, instead of completely flexible. This is a first step in establishing fully functional communication chain. First challenge with the selected approach is to distinguish two different client's behavior. Client connected to CC was coded as an event-based client, which means that in case some event is fulfilled, reading or writing on the serial would be triggered. On the other hand, already existing client connecting the local server with the simulation is a time-based client, constantly writing the values on the server with every simulation time step. Issue was overcome by usage of conditions inside the simulation to make the time-based client an event-based, by constantly reading the values from the local server and comparing it with the current one. In the case that different value was read by reading client, event of writing the new value would be temporary triggered.

Additional challenge of the client is to provide the answer from the local sever in a time span of less than 20 milliseconds. That is a time span for CC to send a request command to devices and receive the correct answer command.

4. Results

This part will provide interesting data for analysis of simulation behavior and thermodynamical pattern implemented using MBD. Suggested HiL concept of testing is still under development and couldn't provide so interesting data like simulation. Due to that, focus is put primarily to outcomes of simulation testing.

4.1. Use cases

The most important use case is testing functionality of the basic VRF controls, such as:

- Proper selection of a targeted IDU
- Running mode
- Set temperatures

Selecting the proper IDU's address is crucial to define in a sending command, otherwise the command would never receive an answer. This way tester could get the impression that system's structure and signal mapping of the commands doesn't work. Running mode was also tested to check the switching logic of a controller and set temperature to see the behavior of the control in corner cases.

4.2. Test results for cooling

First the results of a single zone refrigeration system with 16 IDUs will be shown for summer period, on a characteristic day of 20th July in Madrid, Spain and with duration of 24 hours. These Figures are showing basic information to understanding control behavior of the controller in a simulation. In the Figure 33 temperatures of a single zone consisting of 16 IDUs in comparison to outdoor temperature is shown on a time span of 24 hours. Critical part of the control is in late afternoon because of significant drop in temperature of the zone and inertia of cooling load of so many units at the same time.

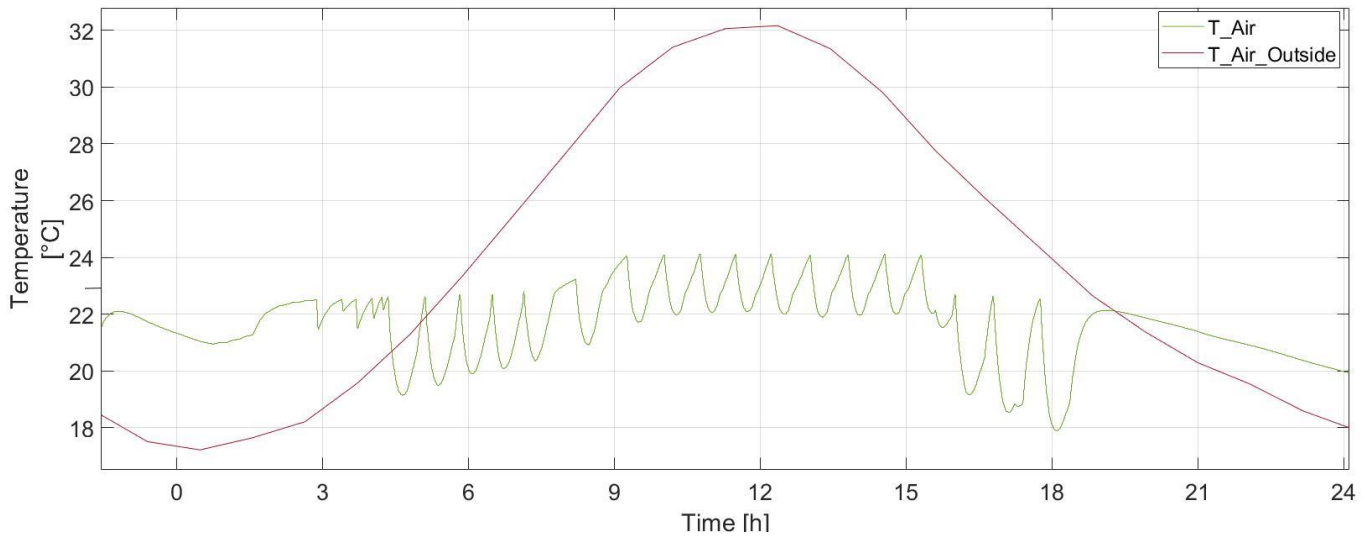

Figure 33. Zone temperature in comparison to outdoor

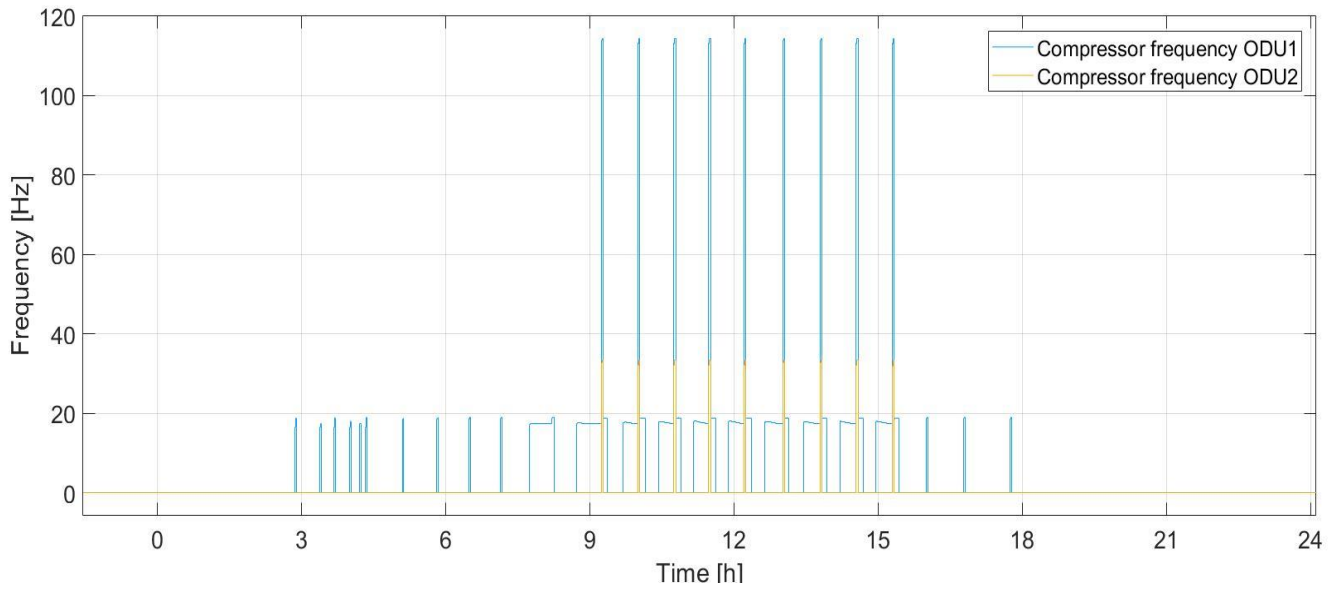

Figure 34. Compressor frequency of ODUs

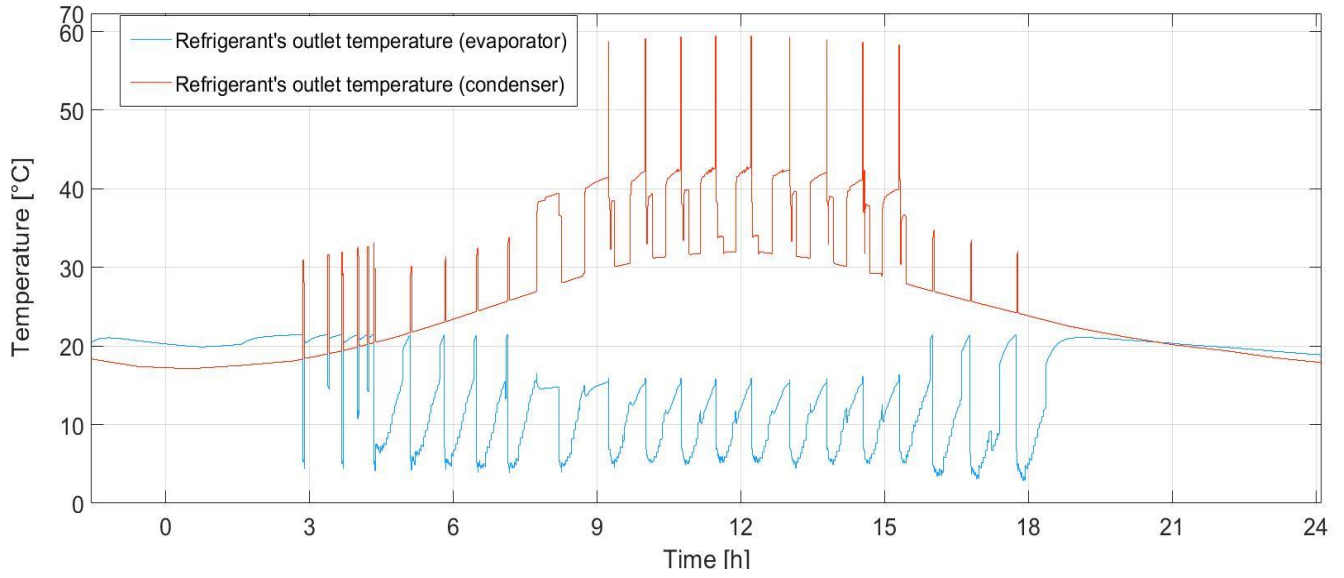

Figure 35. Refrigerant's outlet temperatures

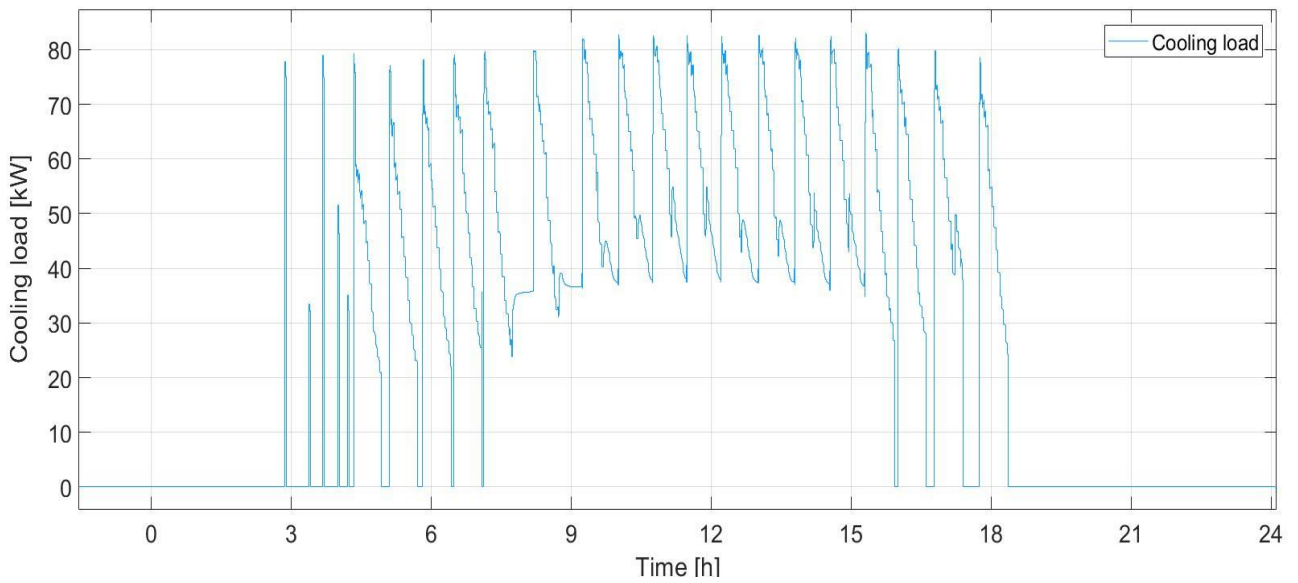

Figure 36. Distribution of cooling load

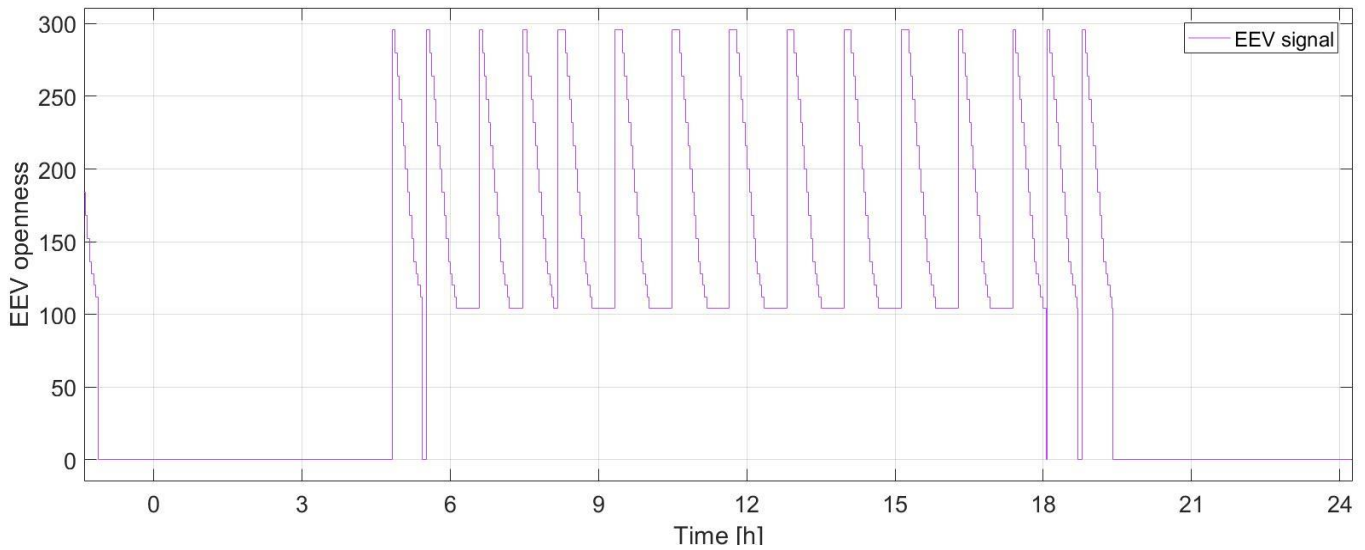

Figure 37. EEV openness (cooling)

In the Figure 34 it is seen that two ODU's are turned during the cooling process in a cascade mode. First one is working most of the time and once the load becomes too high, second ODU is turned on. Different refrigerant temperatures at the exit of ODU and IDU are seen in the Figure 35. When the system is turned off, it is seen that the temperatures are almost equal.

On the other hand, Figure 36 and Figure 37 are more interconnected, showing similar pattern in all figures. In the first one, cooling load distribution is seen, while in the second degree of EEV's openness, according to its internal logic.

Second test case would be selection of parameters according to Figure 31 and presenting the most relevant ones, following the number of units according to Table 3. Initial configuration of big VRF system (95 IDUs and 18 ODU's). As seen in the Figure 38, in some zones temperature behaves acceptable while in others (e.g. zone), system is under dimensioned and temperatures peak up to 33°C indoor. In addition to that, EEV model is built according to physical principles but its control shows repetitive control pattern causing not continuous performance during testing. This problem can be solved by either selecting unit with higher cooling capacity, increasing the number of same units or better cooling control logic of the valve. In the Figure 39 cooling loads of the under dimensioned system can be seen.

Set temperature in each zone is 23 °C, with 21 °C and 25 °C being lower and upper triggering temperatures.

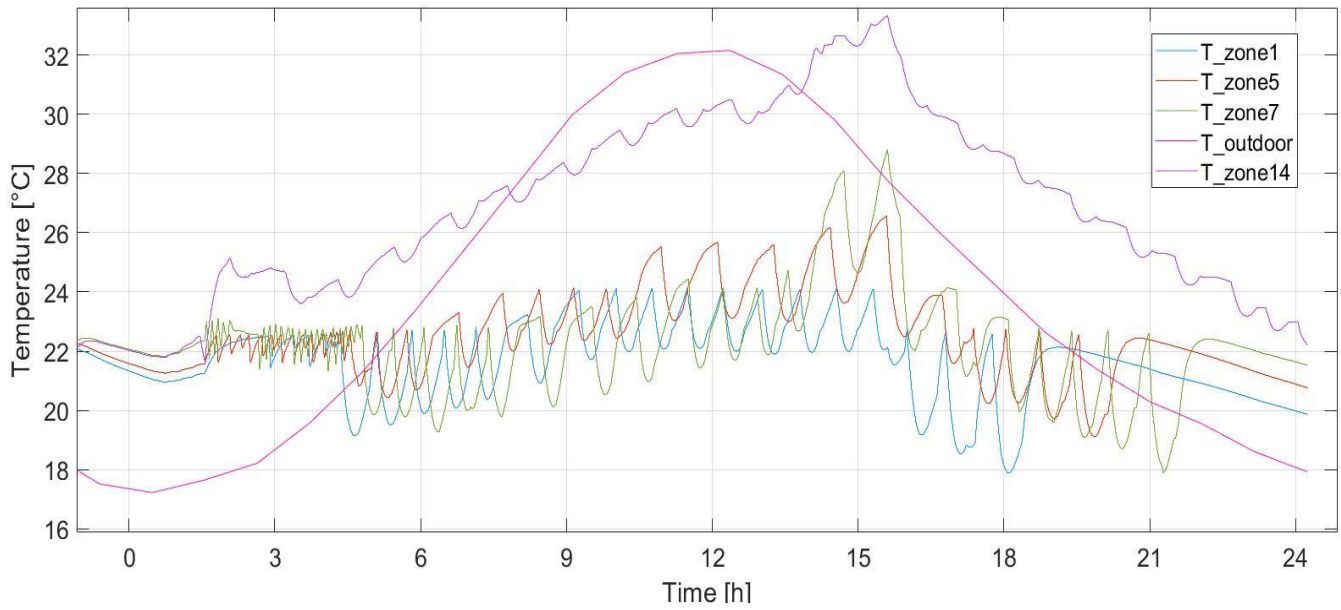

Figure 38. Temperature distribution of under dimensioned system

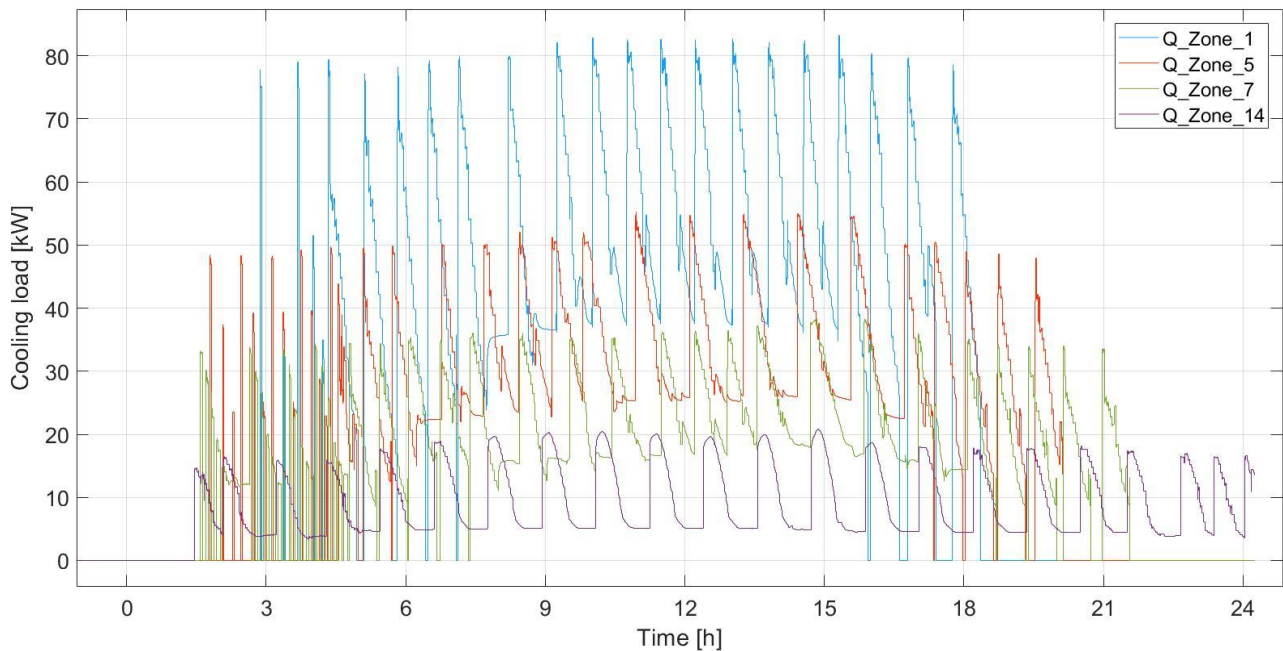

Figure 39. Cooling load of under dimensioned system

By applying suggested measures regarding increase of units where there are too less, new temperature distribution can be seen in the Figure 40, as well as cooling load distribution in the Figure 41. Distribution of IDUs and zones are as on Table 9:

Table 9. Better projected system (cooling)

Zone number	Number of IDUs	Refrigeration system number
1	16	1
2	16	2
3	16	3
4	10	4
5	10	
6	10	
7	7	5
8	7	
9	7	
10	5	6
11	7	
12	5	
13	5	
14	5	
Total	126	-

In the Figure 42, Figure 43, Figure 44 and Figure 45 frequencies of ODUs supplying corresponding units are shown. Each selected zone is a part of one refrigerant system or selected as a whole refrigerant system on its own. One refrigerant system has up to 3 ODUs which run following pattern of cascade mode.

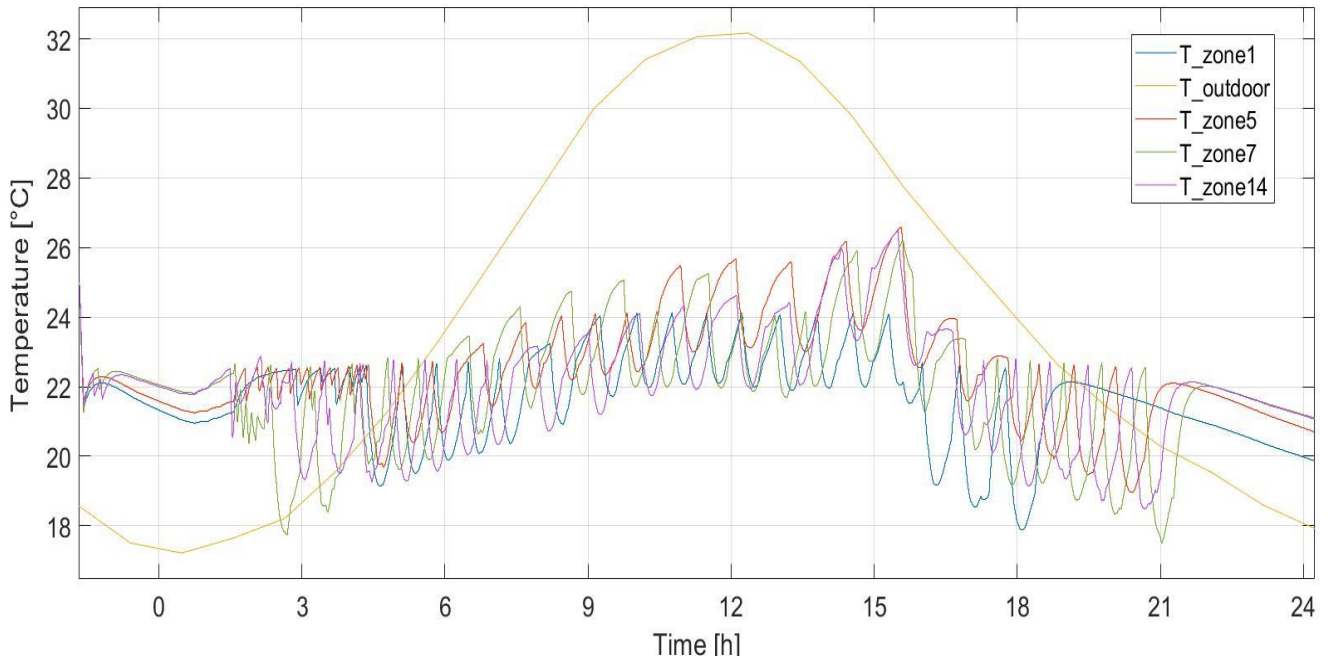

Figure 40. Temperature distribution

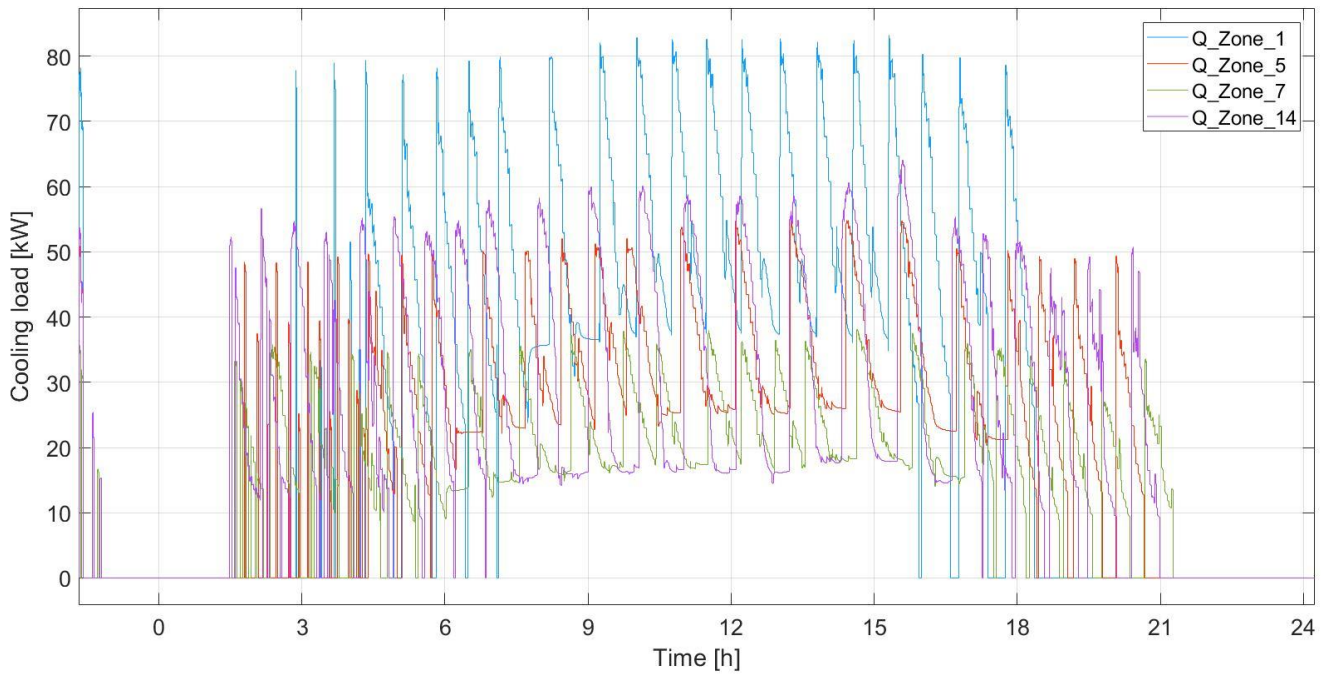

Figure 41. Cooling load

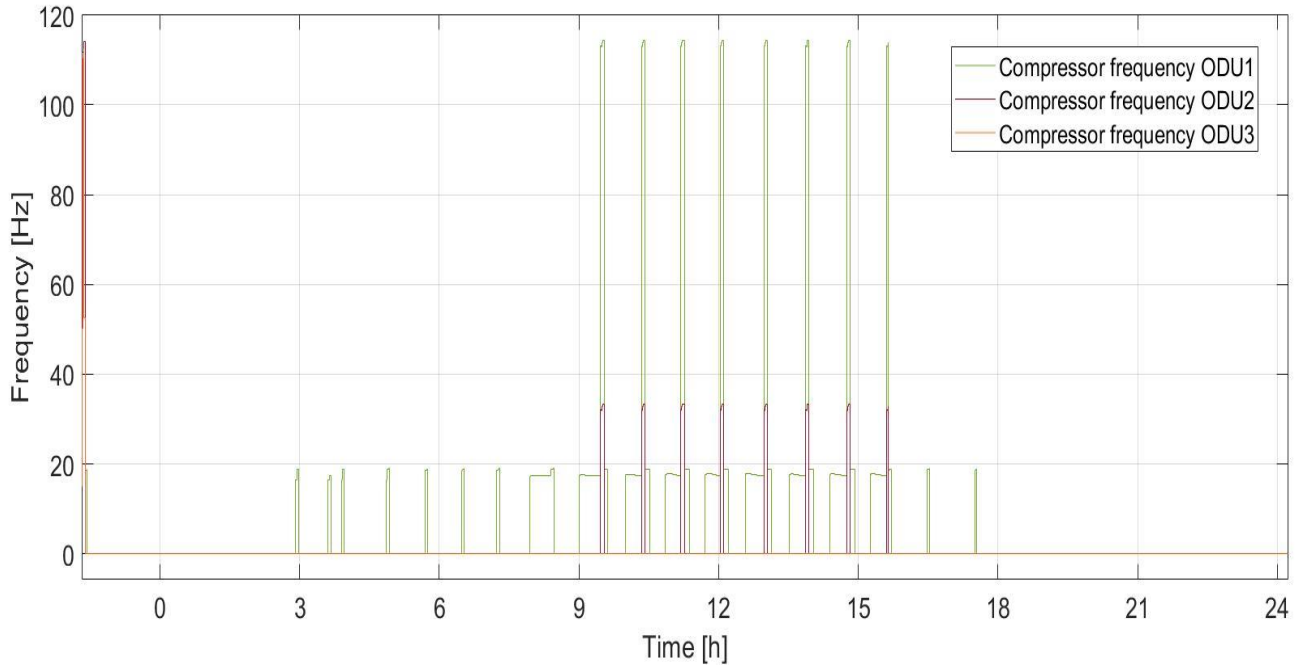

Figure 42. Compressor frequency of zone 1

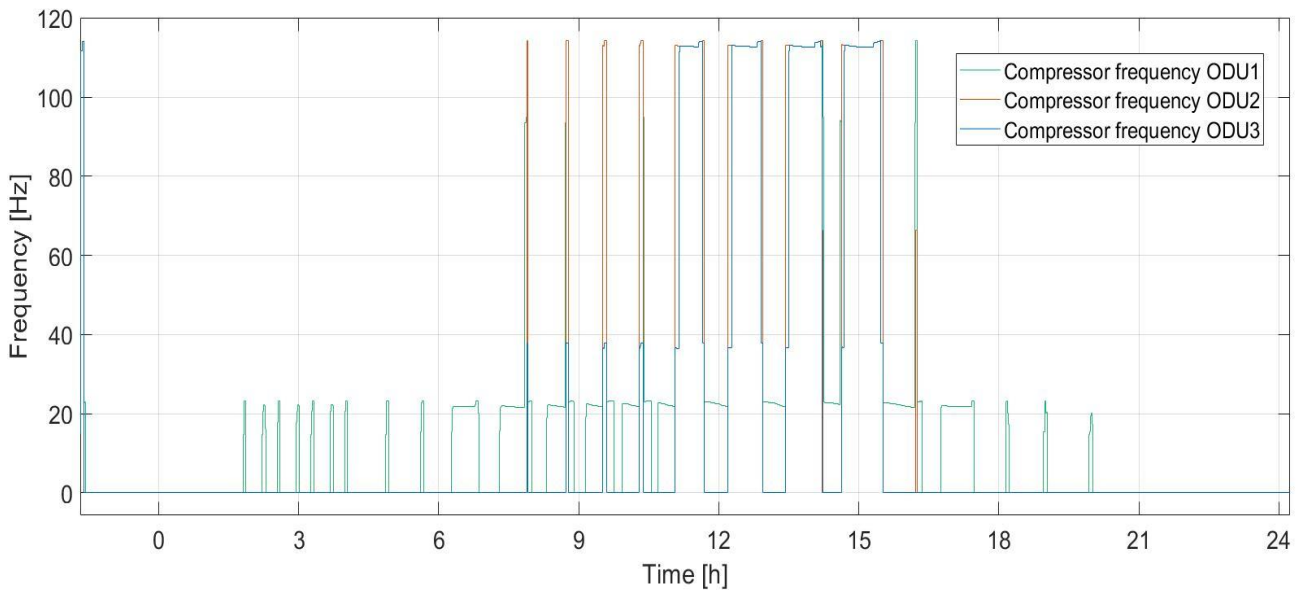

Figure 43. Compressor frequency of zone 5

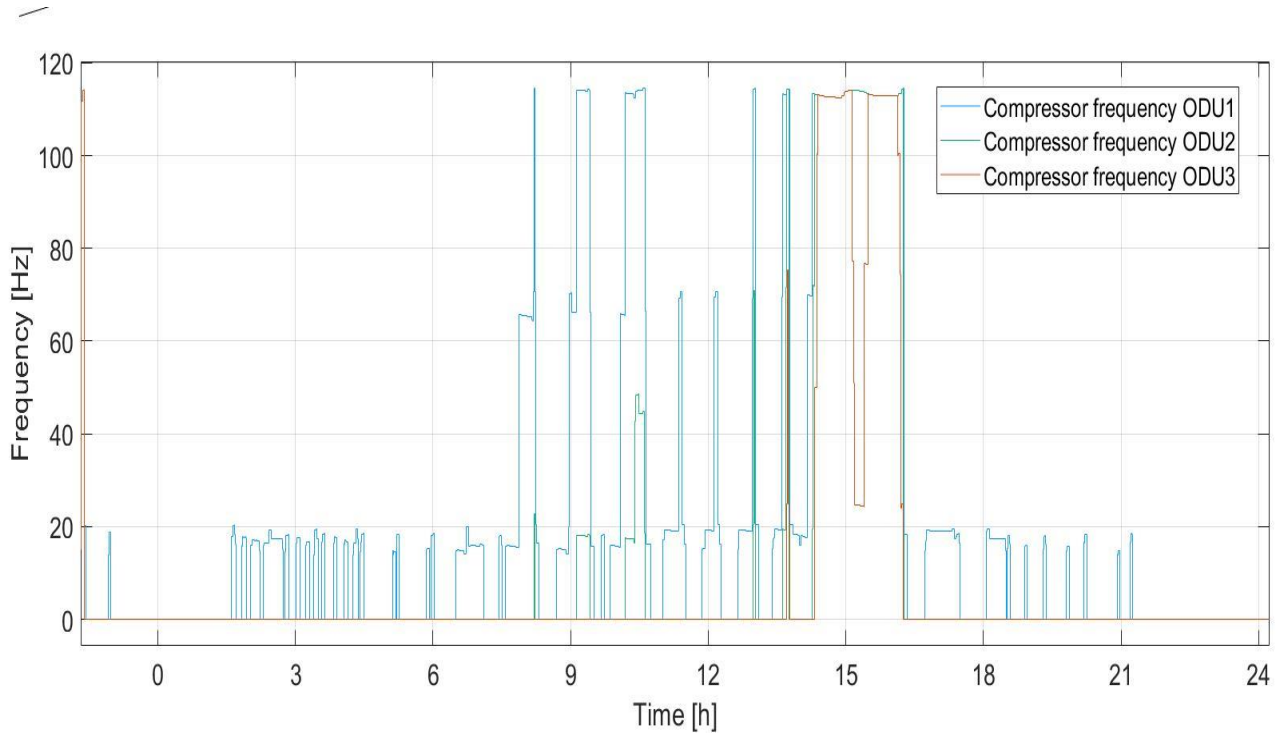

Figure 44. Compressor frequency of zone 7

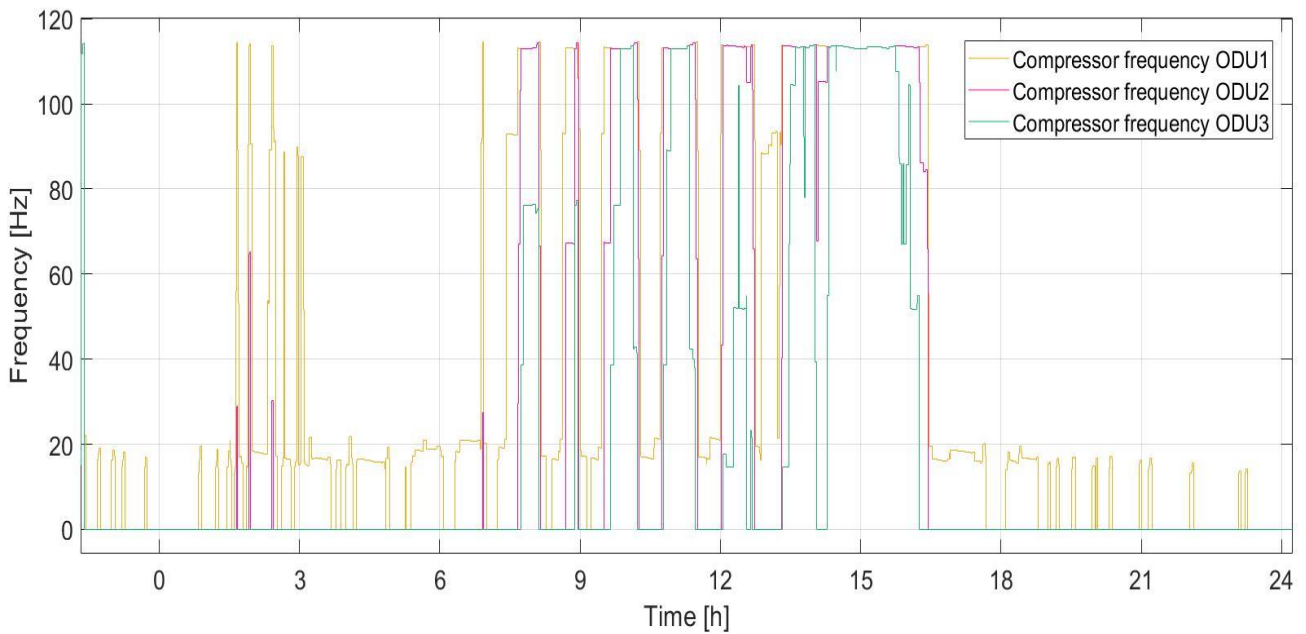

Figure 45. Compressor frequency of zone 14

4.3. Test results for heating

On the other hand, heating results of a single zone refrigeration system with 8 IDUs is presented for characteristic winter day 20th February in Moscow, Russia with duration of 24 hours.

The reason for less units is the fact that heating load combined with many windows, even during winter needs less running units. Simulation works on the principle that all units in the zone run at the same time, easily reaching set temperatures. Following Figures show basic information to understanding control behavior of the controller in a simulation during winter day. In the Figure 46 temperature of a single zone consisting of 8 IDUs in a comparison to outdoor temperature is shown on a time span of 24 hours.

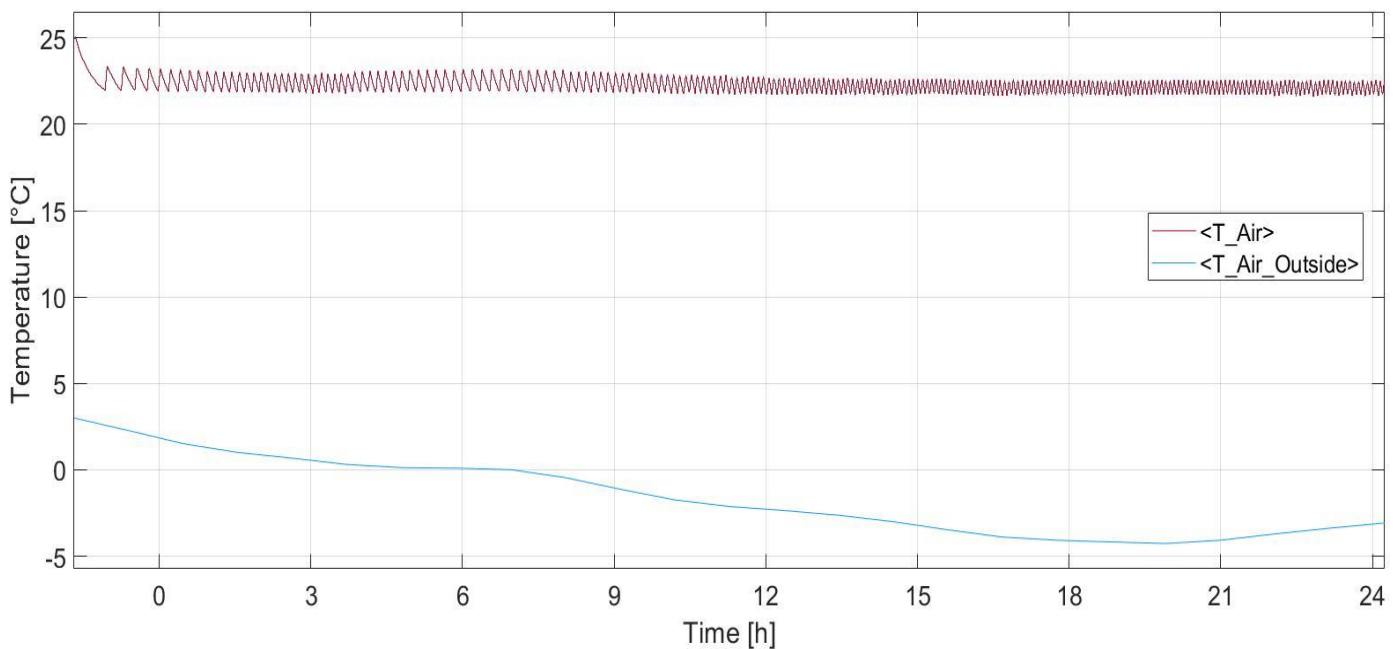

Figure 46. Zone temperature in comparison to outdoor

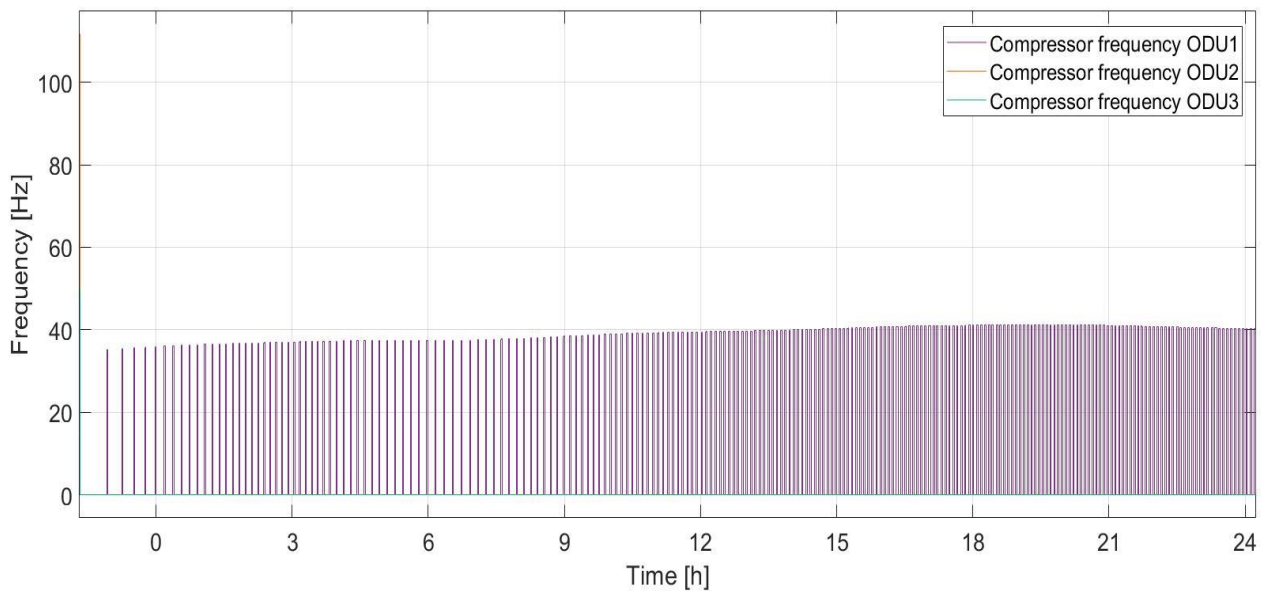

Figure 47. Compressor frequency of ODUs

In the Figure 47, three ODUs are shown, while only one with constant frequency can supply the whole system. It works by the same cascade principle mentioned in “cooling” part of results’ analysis.

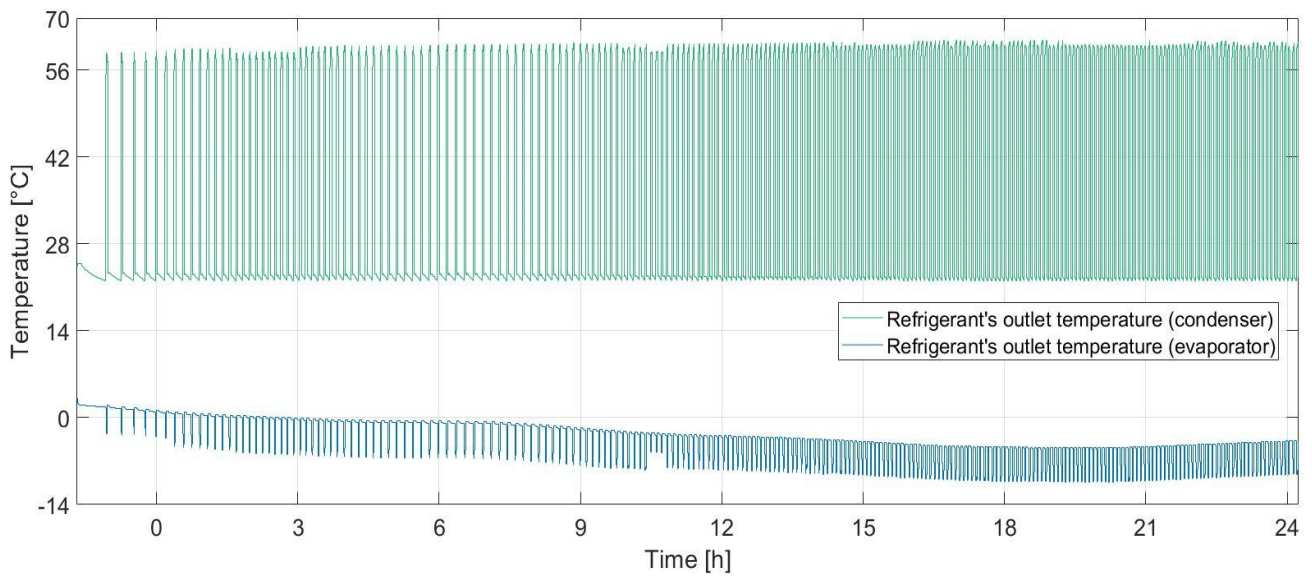

Figure 48. Refrigerant's outlet temperatures

Different refrigerant temperatures at the exit of ODU and IDU are seen in the Figure 48. If the system is turns off, temperatures should have reach same value. In case of heating, systems constantly works and keeps these two temperatures curves apart.

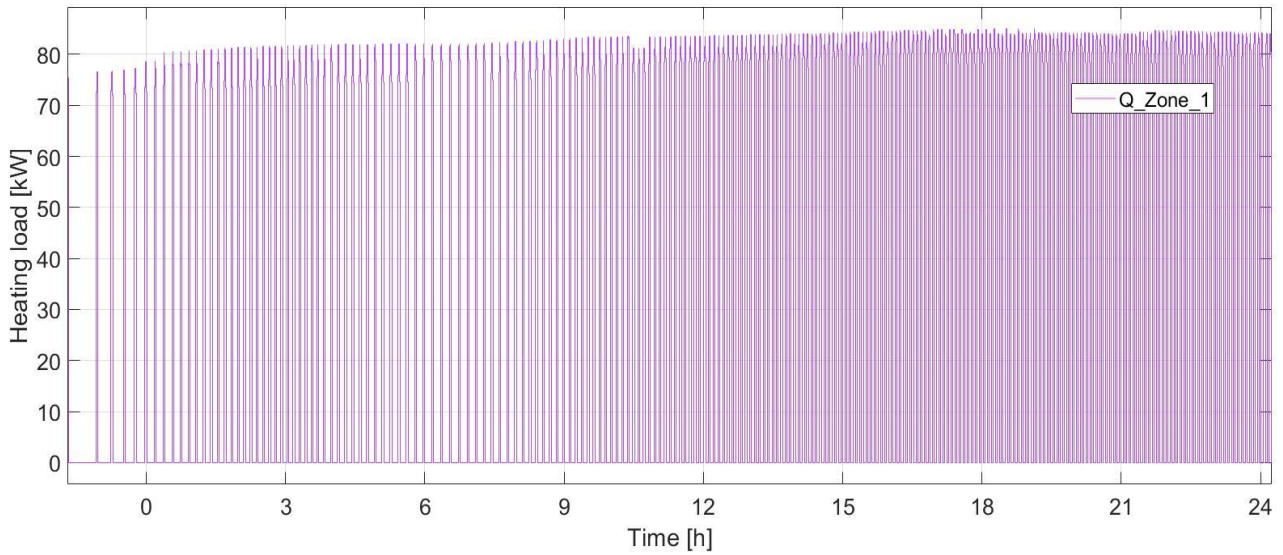

Figure 49. Distribution of heating load

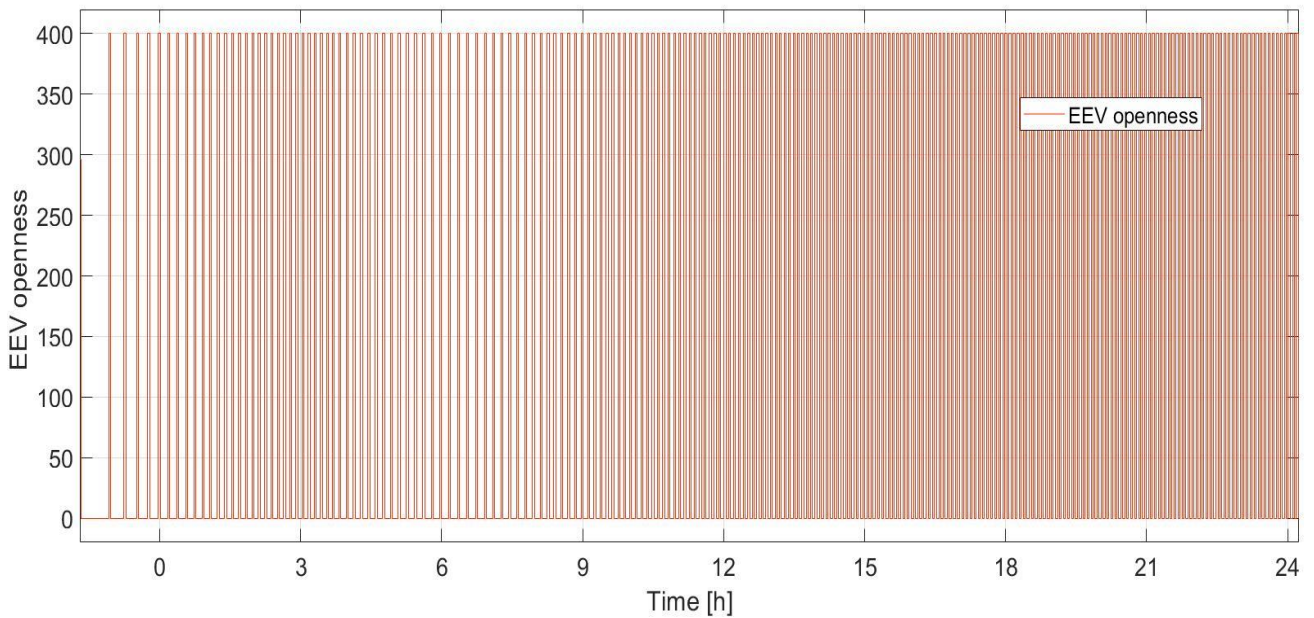

Figure 50. EEV openness (heating)

On the other hand, Figure 49 and Figure 50 are more interconnected, showing similar pattern in all mentioned figures. In the first one, heating load distribution can be seen, while on the second one constant EEV openness.

Additional test case is comparing temperatures of zones referring to Figure 31. Number of units are sorted per zones according to Table 10.

Table 10. Reference system for heating

Zone number	Number of IDUs	Refrigeration system number
1	8	1
2	8	2
3	8	3
4	5	4
5	5	
6	5	
7	3	5
8	3	
9	3	
10	3	6
11	3	
12	3	
13	3	
14	3	
Total	63	-

In the Figure 51 and Figure 52, temperature distribution and compressor frequency of the zone 1 are shown. Pattern is repeatable and in the late afternoon, heating demand increases, causing a small increase in frequency. In the Figure 53, Figure 55 and Figure 57, temperatures of corresponding zones are shown, whereas in Figure 54, Figure 56 and Figure 58 frequencies of compressors.

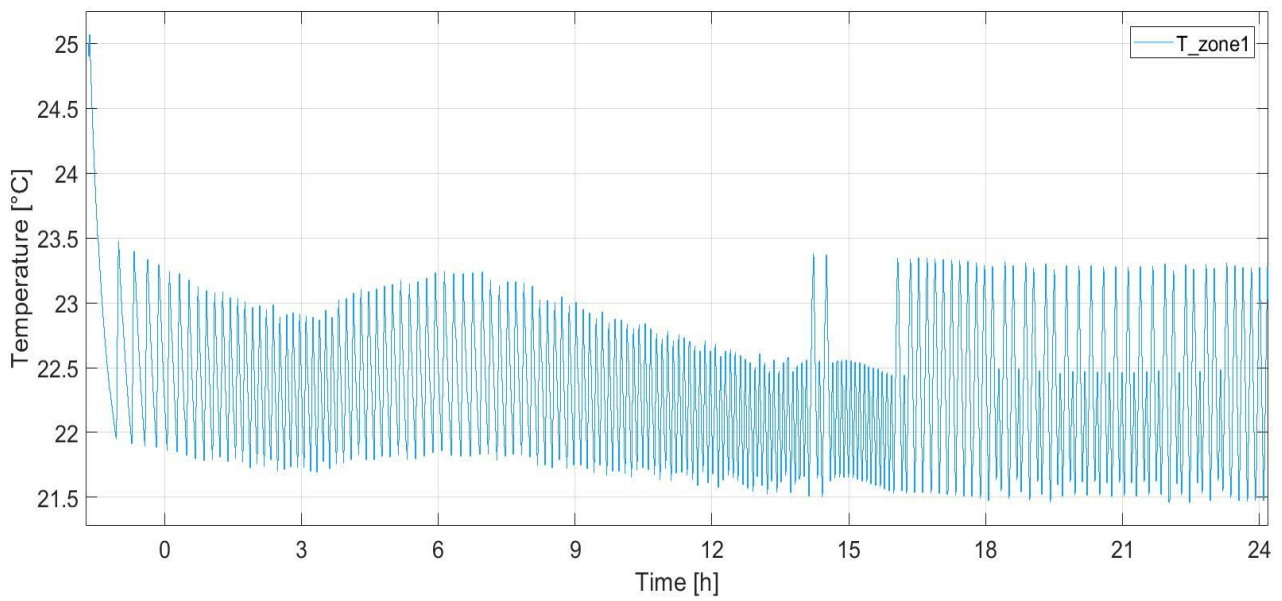

Figure 51. Temperature distribution of zone 1

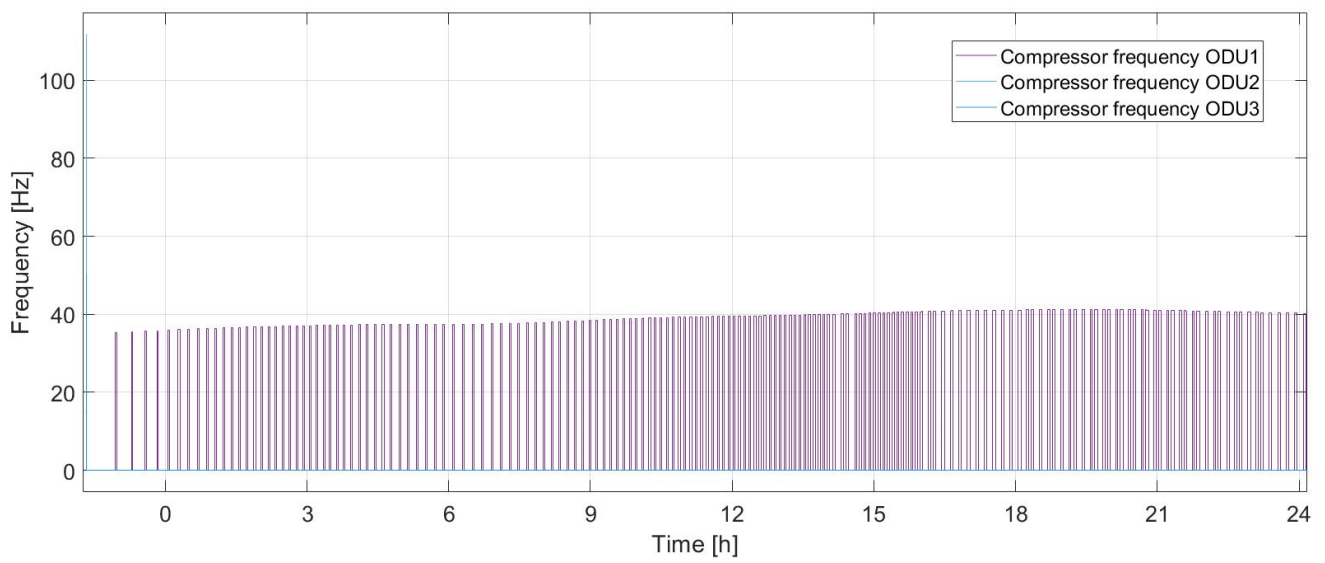

Figure 52. Compressor frequency zone 1

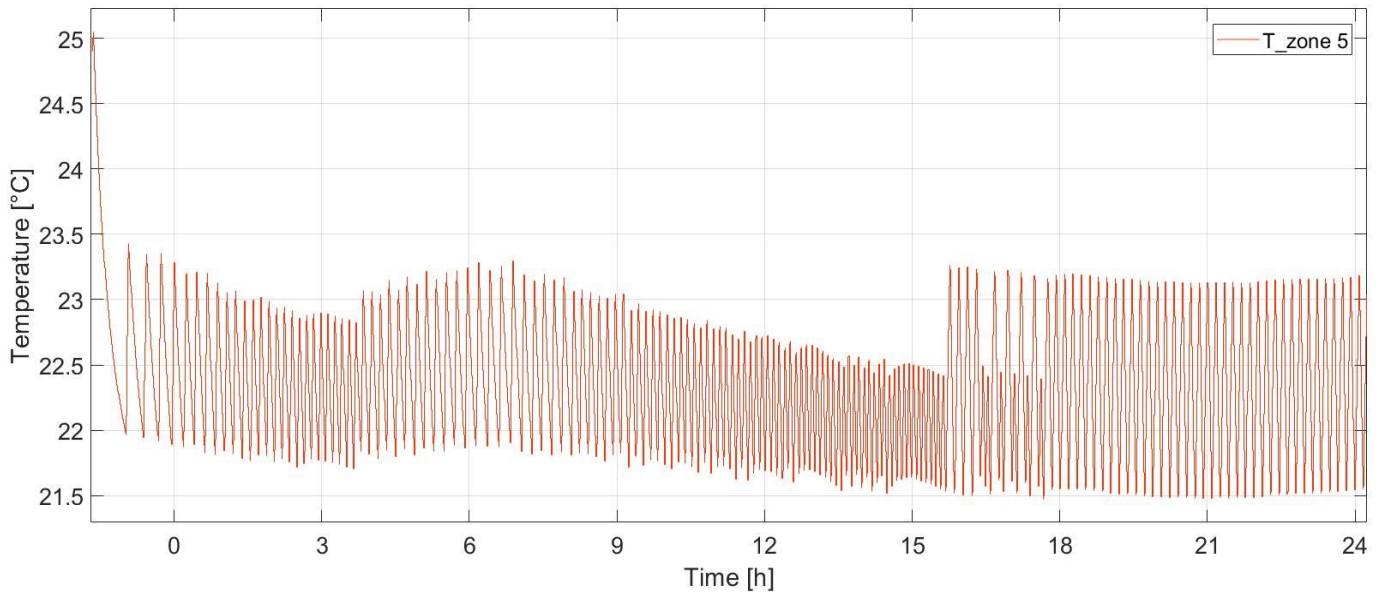

Figure 53. Temperature distribution of zone 5

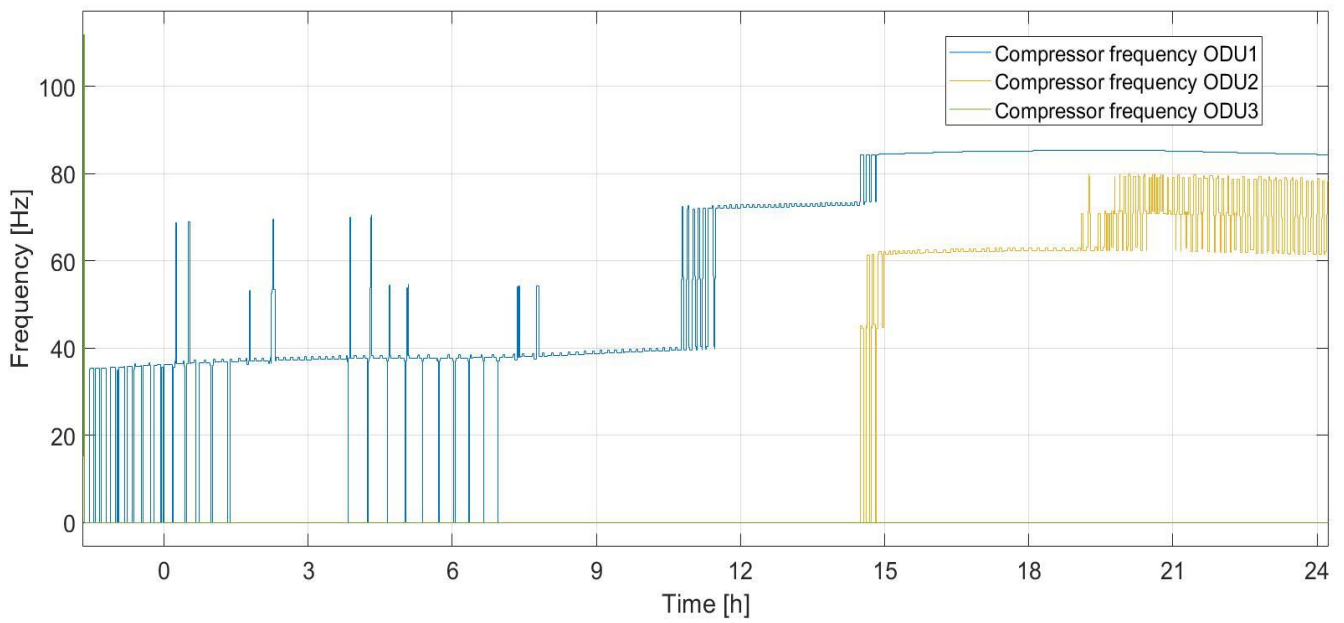

Figure 54. Compressor frequency zone 5

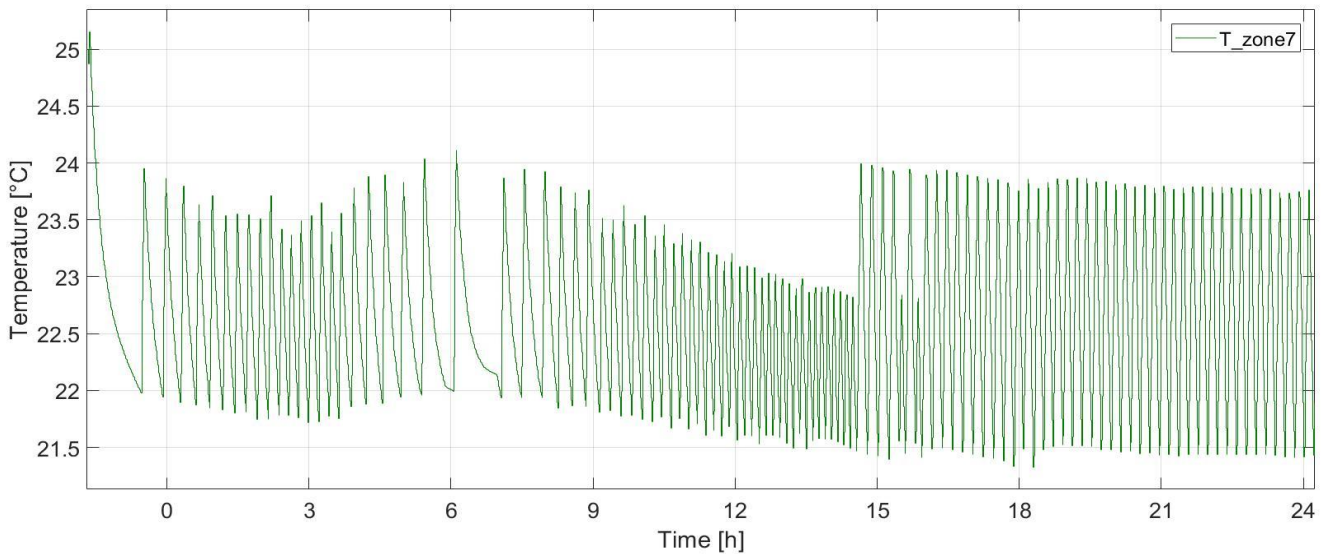

Figure 55. Temperature distribution of zone 7

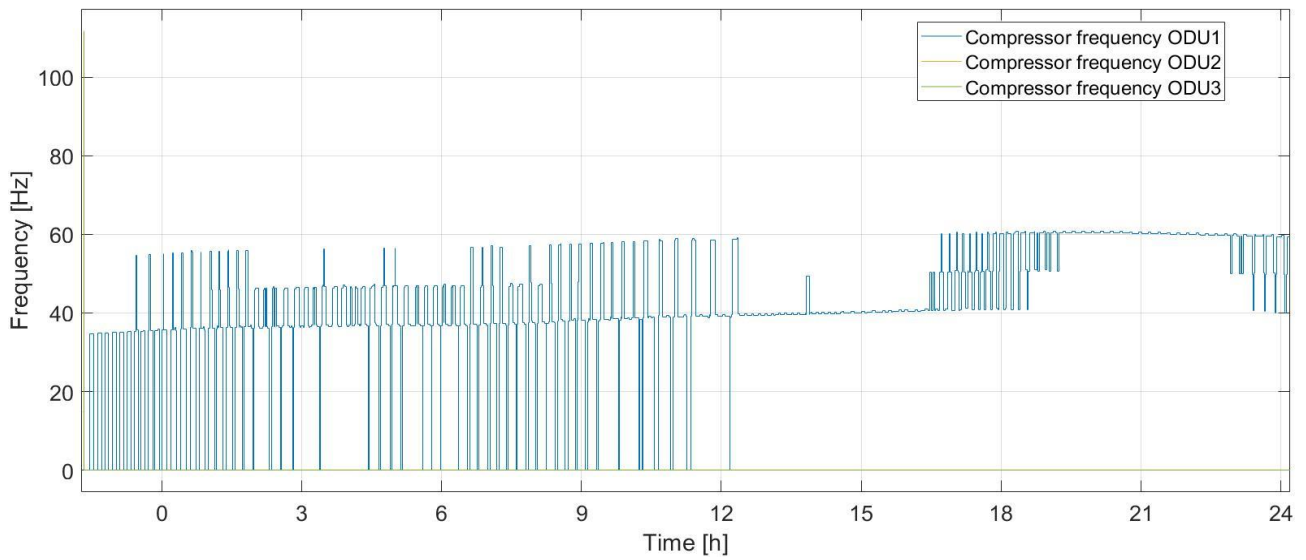

Figure 56. Compressor frequency zone 7

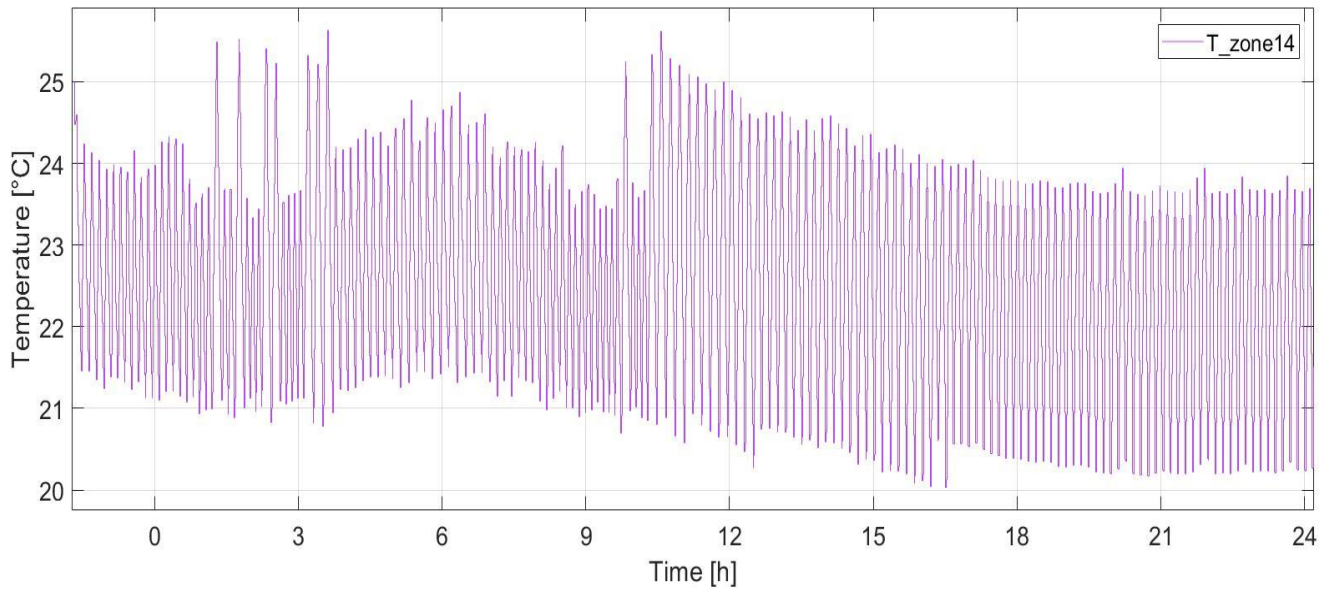

Figure 57. Temperature distribution of zone 14

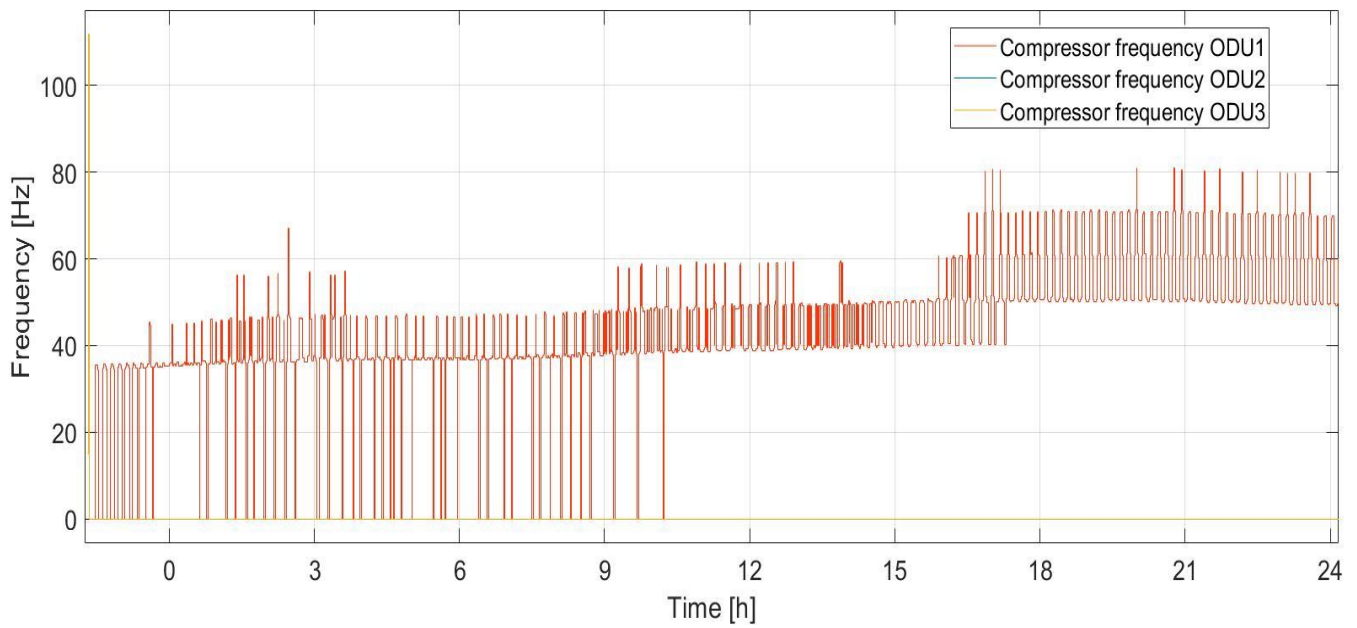

Figure 58. Compressor frequency zone 14

4.4. Comparison of the results

In this chapter, interesting comparison of values are to be shown. As seen in the Figure 59, with increased infiltration of the outdoor summer air, temperature inside the zone will slightly increase. On the other side, in the Figure 60 higher infiltration rate means significant drop of indoor temperature.

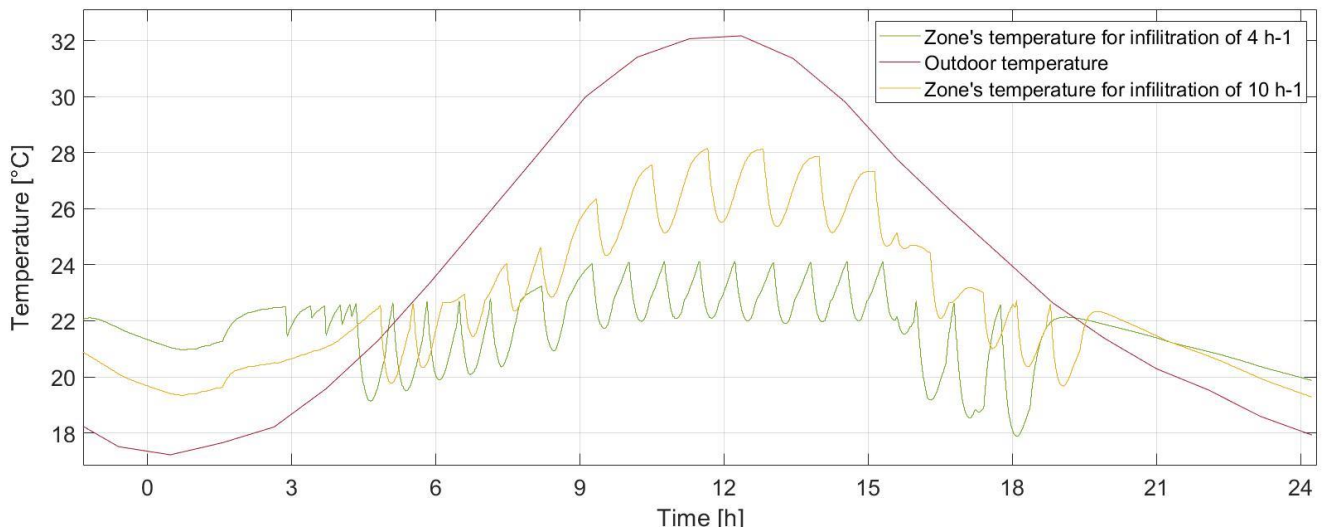

Figure 59. Different infiltration rates (cooling)

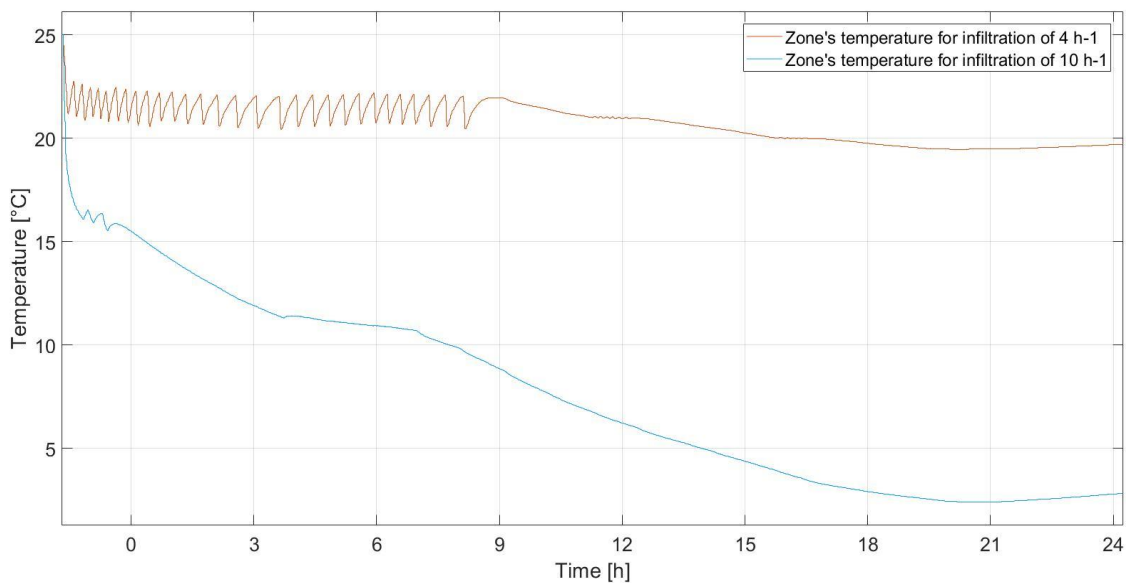

Figure 60. Different infiltration rates (heating)

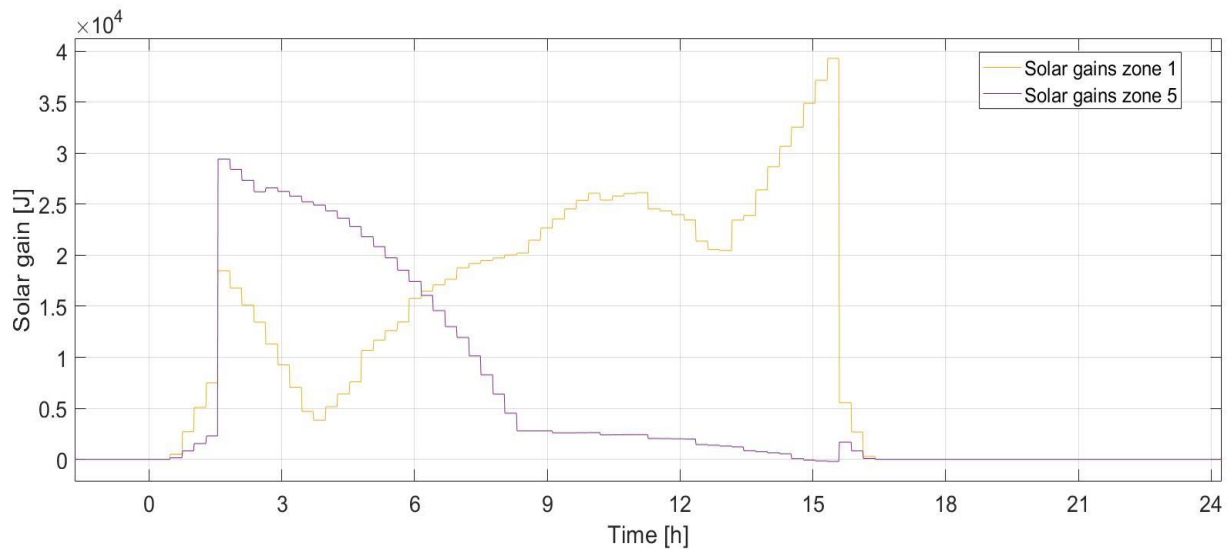

Figure 61. Solar gains in Zone 1 and Zone 5

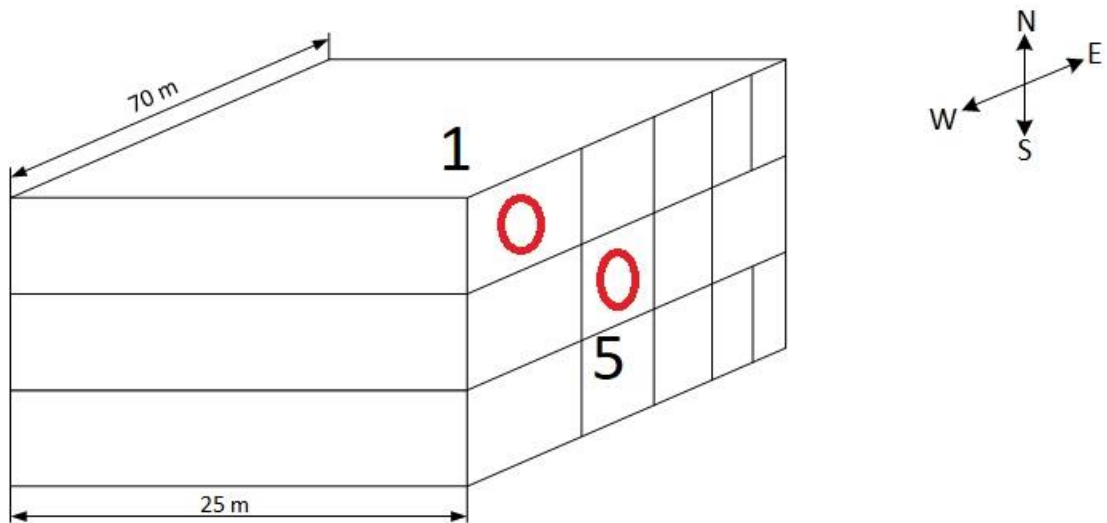

Figure 62. Zone 1 and 5 (solar gains)

As seen in the Figure 62, zones 1 and 5 are selected and solar heat gains are showed in the Figure 61. The last one shows dynamical heat gains depending on orientation of the world (defined in Table 8), combined with exposure of the zone to the sun. It shows how world's orientation depends on solar gains and number of IDUs.

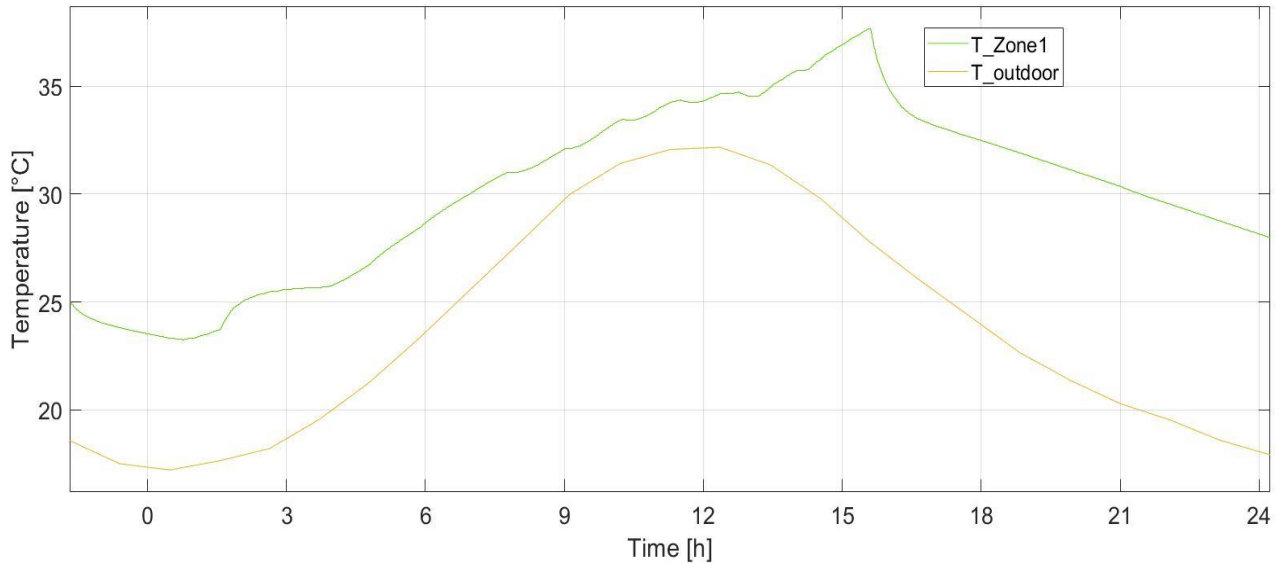

Figure 63. RC building model without HVAC running system (cooling)

Figure 63 shows the behavior of RC building model with no running HVAC system in characteristic summer day. In building with high windows glazing factor like the one that is under test, combined with summer solar gains, temperature peaks up to 38°C indoor, which shows that no modern glassy building can stand with no HVAC system running in summer. In the Figure 64 zone temperatures drops significantly fast with initial guess value of 25°C.

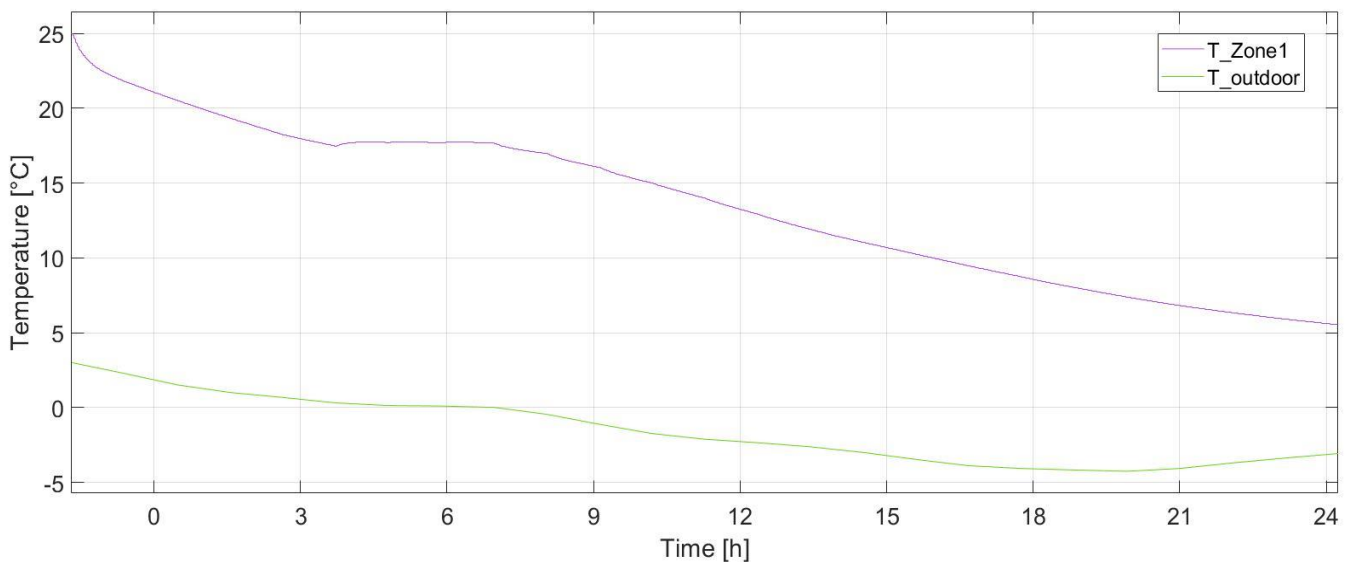

Figure 64. RC building model without HVAC running system (heating)

5. Conclusion

This approach gives a tremendous amount of developing freedom, having no obstacles from size of VRF system and number of cooling/heating zones, possibility of choosing a custom made building for individual purposes, visualizing that on a single controller and testing it against its full communication protocol.

Backsides of applied development approach are very few. Since the approach is still under constant development, there are no many experts in this mutable field, and no open source applications. Companies are developing this for their own purposes and some others are just buying state of the art solutions. Time used to create HiL configuration is considerable and lot of obstacles are to be met. In order to better understand the system's behavior and communication among devices, it is best to develop it fully from the scratch, not investing time in understanding some already existing parts of the chain, which sometimes won't be used in a final product. Coding clients in Python gives additional freedom for future test automation frameworks that could reduce developing and testing time significantly, in order to invest more time in building new features and boosting the functions of the controller.

6. Bibliography

- [1] "Innovations," National Instruments, [Online]. Available: <https://www.ni.com/de-de/innovations/white-papers/17/what-is-hardware-in-the-loop-.html>. [Accessed 06. 04. 2020].
- [2] "Air center control," Bosch Thermotechnology, [Online]. Available: <https://www.bosch-thermotechnology.com/global/en/ocs/commercial-industrial/air-center-control---acc-1101652-p/>. [Accessed 28. 03. 2020].
- [3] D. Firesmith, "Carnegie Mellon University," 11. 11. 2013. [Online]. Available: https://insights.sei.cmu.edu/sei_blog/2013/11/using-v-models-for-testing.html. [Accessed 06. 05. 2020].
- [4] J. O. Paul Ammann, Introduction to Software Testing, Cambridge University Press, 2017.
- [5] Thomas Schütz, Protos, [Online]. Available: <https://www.protos.de/hardware-in-the-loop-for-everybody/> . [Accessed 25. 06. 2020].
- [6] Ryan Gordon, Michael Carone, "Introduction to MBD modelling and simulation with Simulink," Mathworks, 2015. [Online]. Available: <https://www.youtube.com/watch?v=XrPxU2RAyVI>. [Accessed 01. 06. 2020].
- [7] J. O. Paul Ammann, Introduction to Software Testing, Cambridge University Press, 2008.
- [8] B. L. Mark Utting, Pratical Model-Based testing, a tools approach, Elsevier, 2017.
- [9] Martin-W.Buchenau, "Der neue Star der Sicherheitsbranche," 22. 06. 2012. [Online]. Available: <https://www.wiwo.de/unternehmen/industrie/bosch-der-neue-star-der-sicherheitsbranche/6786328.html> . [Accessed 05. 06. 2020].
- [10] J. L. Q. C. Hongsen Shi, "HVAC Precooling Optimization for Green Buildings: An RC-Network Approach," *e-Energy*, 2018.
- [11] L. N. G. P. R. B. Bruno Bueno, "A resistance-capacitance network model for the analysis of the intereaction between the energy performance of buildings and the urban climate," *Building and Environment*, pp. 116-125, 2012.

- [12] F. B. M. B. Mohammad Ali Fayazbakhsh, "A Resistance–Capacitance Model for Real-Time Calculation of Cooling Load in HVAC-R Systems," *Journal of Thermal Science and Engineering Applications*, 2015.
- [13] Fond za Zaštitu Okoliša i Energetsku Učinkovitost, "Priručnik za energetske certificiranje zgrada," [Online]. Available: <http://www.enu.fzoeu.hr/data/prircert.pdf> . [Accessed 16. 06. 2020].
- [14] M. B. Yanus Cengel, *Thermodynamics: An Engineering Approach*, McGraw-Hill, 2006.
- [15] A. Galović, *Termodinamika 2*, Zagreb: Fakultet strojarstva i brodogradnje , 2012.
- [16] M. M. Shah, "A new correlation for heat transfer during boiling flow through pipes," *ASHRAE* , 1976.
- [17] M. M. Shah, "An Improved and Extended General Correlation for Heat Transfer During Condensation in Plain Tubes," *ASHRAE*, vol. 15, 2009.
- [18] K. E. G. a. R. H. S. Winterton, "A general correlation for flow boiling in tubes and annuli," *Heat Mass Transfer*, vol. 29, pp. 351-358, 1985.
- [19] P.-Q. V. K. I. C. J.-T. O. Nguyen-Ba Chien, "A General Correlation to Predict The Flow Boiling Heat Transfer of R410a in Macro/Mini Channels," Purdue University, 2014. [Online]. Available: <https://docs.lib.purdue.edu/cgi/viewcontent.cgi?article=2465&context=iracc>. [Accessed 22. 06. 2020].
- [20] "The Nobel Prize in Chemistry 1995," 1995. [Online]. Available: <https://www.nobelprize.org/prizes/chemistry/1995/summary/>. [Accessed 02. 05. 2020].
- [21] European Commission, "EU legislation to control F-gases," 2015. [Online]. Available: https://ec.europa.eu/clima/policies/f-gas/legislation_en. [Accessed 21. 04. 2020].
- [22] V. Z. A. M. G. T. Č. V. Soldo, "Properties of Alternative Refrigerants," Faculty of Mechanical Engineering and Naval Architecture, Zagreb, [Online]. Available: <https://www.fsb.unizg.hr/rmp/Svojstva%20zamjenskih%20radnih%20tvari.pdf> . [Accessed 19. 05. 2020].

- [23] Perfect Aire, "Switching to R32 from R410A: Why Manufacturers are Switching Refrigerants," Perfect Aire, 22. 03. 2019. [Online]. Available: <https://perfectaire.us/2019/03/22/switching-to-r32-from-r410a-why-manufacturers-are-switching-refrigerants/>. [Accessed 23. 05. 2020].
- [24] "Heat Pump Reversing Valve," [Online]. Available: <http://www.heatpump-reviews.com/Heat-Pump-Reversing-Valve.html>. [Accessed 30. 06. 2020].
- [25] Bosch, "Climate 5000 VRF," [Online]. Available: https://www.bosch-thermotechnology.com/ocsmedia/optimized/full/o375403v272_Bosch_Klima_5000_VRF_S5DCI_Series_en.pdf. [Accessed 17. 04. 2020].
- [26] California State Polytechnic University, *ASHRAE Student Design Competition System Selection*, Pomona, 2016.
- [27] John Tomczyk, "Liquid Refrigerant, Dense Vapors Can Damage Compressors," The News, 02. 05. 2020. [Online]. Available: <https://www.achrnews.com/articles/143096-liquid-refrigerant-dense-vapors-can-damage-compressors>. [Accessed 24. 06. 2020].
- [28] "FAB Academy," [Online]. Available: <http://fab.academany.org/2019/labs/vigyanashram/students/jayadip-sarode/Assignment14/Assignment14.html> .
- [29] Loren Dean, Mathworks, "Parallel Computing with MATLAB and Simulink," 2017. [Online]. Available: <https://www.matlabexpo.com/content/dam/mathworks/mathworks-dot-com/images/events/matlabexpo/fr/2017/parallel-computing-with-matlab-simulink.pdf> . [Accessed 21. 06. 2020].
- [30] Midea, "Service Manual V6-i Series," [Online]. Available: <http://midea.com.ge/uploads/client/Uploads/Catalogues/V6-i%20Series%20Service%20Manual.pdf> . [Accessed 29. 06. 2020].