

Priprema radioničke dokumentacije upotrebom programa AVEVA

Matić, Saša

Master's thesis / Diplomski rad

2018

Degree Grantor / Ustanova koja je dodijelila akademski / stručni stupanj: **University of Zagreb, Faculty of Mechanical Engineering and Naval Architecture / Sveučilište u Zagrebu, Fakultet strojarstva i brodogradnje**

Permanent link / Trajna poveznica: <https://urn.nsk.hr/urn:nbn:hr:235:407023>

Rights / Prava: [In copyright](#)/[Zaštićeno autorskim pravom.](#)

Download date / Datum preuzimanja: **2024-07-14**

Repository / Repozitorij:

[Repository of Faculty of Mechanical Engineering and Naval Architecture University of Zagreb](#)



SVEUČILIŠTE U ZAGREBU
FAKULTET STROJARSTVA I BRODOGRADNJE

DIPLOMSKI RAD

Saša Matić

Zagreb, 2018.

SVEUČILIŠTE U ZAGREBU
FAKULTET STROJARSTVA I BRODOGRADNJE

DIPLOMSKI RAD

Mentor:

Doc. dr. sc. Neven Hadžić, dipl. ing.

Student:

Saša Matic

Zagreb, 2018.

Izjavljujem da sam ovaj rad izradio samostalno koristeći znanja stečena tijekom studija i navedenu literaturu.

Posebno se zahvaljujem mentoru Dr. sc. Nevenu Hadžiću na savjetima i pomoći tijekom izrade ovog rada.

Zahvaljujem se roditeljima, sestri i maloj obitelji na vjeri, razumijevanju i podršci.

Saša Matić



Sveučilište u Zagrebu Fakultet strojarstva i brodogradnje	
Datum	Prilog
Klasa:	
Ur.broj:	

DIPLOMSKI ZADATAK

Student:

Saša Matić

Mat. br.: 0035123691

Naslov rada na
hrvatskom jeziku:

**PRIPREMA RADIONIČKE DOKUMENTACIJE UPOTREBOM
PROGRAMA AVEVA**

Naslov rada na
engleskom jeziku:

**HULL CONSTRUCTION DOCUMENTATION PREPARATION
USING AVEVA SOFTWARE**

Opis zadatka:

Suvremena računala i CAD/CAM sustavi omogućuju kvalitetnu pripremu tehnološke dokumentacije poput radioničkih nacрта, tehnoloških uputa te radioničke i narudžbene specifikacije koja ima nezaobilaznu ulogu tijekom faze detaljnog projektiranja i fizičke realizacije broda kako sa stanovišta planiranja proizvodnje tako i s aspekta tehnoložnosti gradnje.

Stoga je u diplomskom radu na primjeru sekcije boka tipičnog putničkog brod potrebno:

1. Izraditi model sekcije nadgrađa putničkog broda,
2. Provesti raskroj materijala i izraditi radioničku i narudžbenu specifikaciju materijala,
3. Provesti podjelu sekcije na sklopove,
4. Izraditi radioničku dokumentaciju za izradu i predmontažu sklopova i sekcije nadgrađa,
5. Izraditi tehnološku uputu za izradu i predmontažu sklopova sekcije i sekcije nadgrađa.

Tijekom rada koristiti i program AVEVA.

Zadatak zadan:

3. svibnja 2018.

Datum predaje rada:

5. srpnja 2018.

Predviđeni datumi obrane:

11., 12. i 13. srpnja 2018.

Zadatak zadao:

Doc. dr. sc. Neven Hadžić

Predsjednica Povjerenstva:

Nasrta Degiuli
Prof. dr. sc. Nasrta Degiuli

SADRŽAJ

SADRŽAJ	I
POPIS SLIKA	II
POPIS TABLICA.....	III
POPIS TEHNIČKE DOKUMENTACIJE	IV
POPIS OZNAKA	V
SAŽETAK.....	VI
SUMMARY	VII
1. UVOD.....	1
1.1. Uporaba AVEVA Marine programskog alata.....	1
2. IZRADA MODELA SEKCIJE NADGRAĐA PUTNIČKOG BRODA.....	3
2.1. Koncept definiranja sekcije i njenih sklopova	3
2.2. Sučelje za definiranje modela sekcije i njenih sklopova.....	4
3. RASKROJ MATERIJALA I IZRADA RADIONIČKE I NARUDŽBENE SPECIFIKACIJE MATERIJALA	8
3.1. Tradicionalna metoda razvijanja lima.....	8
3.2. Raskroj materijala	9
3.3. Okrupnjavanje limova palube	14
3.4. Izrada radioničke specifikacije materijala.....	17
3.5. Izrada narudžbene specifikacije materijala	21
3.6. Revizija radioničke dokumentacije	29
4. PODJELA SEKCIJA NA SKLOPOVE	30
4.1. Definiranje naziva sklopa.....	30
4.2. Određivanje pozicijskih brojeva podsklopova.....	32
5. RADIONIČKA DOKUMENTACIJA ZA IZRADU SEKCIJE NADGRAĐA.....	35
5.1. Izrada radioničkih nacrt.....	35
6. TEHNOLOŠKA UPUTA ZA IZRADU I PREDMONTAŽU SKLOPOVA SEKCIJE I SEKCIJE NADGRAĐA.....	38
6.1. Smještaj bloka GB730	38
6.2. Izrada i predmontaža sekcije palube GN7341	38
6.3. Izrada i predmontaža sekcije palube GN7342 i sekcije oplata boka GN7343	41
6.4. Kompletiranje grand bloka GB730	44
7. ZAKLJUČAK.....	46
LITERATURA.....	48
PRILOZI.....	49

POPIS SLIKA

Slika 1.	Moduli za rad u AVEVA Marine, [2]	2
Slika 2.	Podjela broda na blokove, [3].....	3
Slika 3.	Sučelje za definiciju sklopa, [3]	4
Slika 4.	Vrste zavara i popis šavova, [5]	6
Slika 5.	3D model sekcije nadgrađa GN7342, [5].....	7
Slika 6.	Trasiranje lima, [7]	8
Slika 7.	Raskroj materijala, [5]	13
Slika 8.	Raskroj limova palube, [5]	15
Slika 9.	Spajanje limova palube, [5].....	16
Slika 10.	Odabir funkcijskog koda, [9].....	19
Slika 11.	Linija za predmontažu sklopova Meyer Turku, [9].....	20
Slika 12.	Optimiziranje naručenih limova, [5]	22
Slika 13.	Revizija radioničke dokumentacije, [5].....	29
Slika 14.	Sklop i podsklop, [5]	31
Slika 15.	Određivanje naziva sklopa, [5].....	32
Slika 16.	Popis standardnih dijelova, [9].....	33
Slika 17.	Radionički nacrt sklopa, [5]	36
Slika 18.	Priprema krajeva profila, [5]	37
Slika 19.	Zavarivanje limova palube, [10]	39
Slika 20.	Roštilj palube sekcije GN7341, [5]	40
Slika 21.	Privremeno ukrepljenje upora, [11].....	41
Slika 22.	Privremeni otvori za transport, [12]	42
Slika 23.	Sekcija oplata iz iste serije brodova	43
Slika 24.	Grand blok GB730, [5].....	44
Slika 25.	Brod iz iste serije u suhom doku, [13].....	45

POPIS TABLICA

Tablica 1. Dodatak za materijal, [4]	5
Tablica 2. Limovi na skladištu, [8].....	9
Tablica 3. Profili na skladištu, [8]	11
Tablica 4. Narudžbeni popis limova za sekciju GN7342	23
Tablica 5. Narudžbena lista profila za sekciju GN7342.....	28

POPIS TEHNIČKE DOKUMENTACIJE

BROJ CRTEŽA	Naziv iz sastavnice
D.394.0734.327.001	PREGRADE ISPOD 14. PALUBE
D.394.0734.327.001_2	PREGRADE ISPOD 14. PALUBE
D.394.0734.327.001_3	PREGRADE ISPOD 14. PALUBE
D.394.0734.327.001_4	PREGRADE ISPOD 14. PALUBE

POPIS OZNAKA

Oznaka	Jedinica	Opis
<i>t</i>	mm	debljina materijala
R_e	N/mm ²	granica razvlačenja
<i>m</i>	kg	masa
<i>L</i>	mm	duljina lima
<i>H</i>	mm	visina lima
shr	/	dodatak za materijal
<i>h</i>	mm	visina HP profila
Φ	mm	promjer kružnog profila
<i>b</i>	mm	širina ravnog profila
<i>l</i>	mm	duljina profila

SAŽETAK

Brodograđevna djelatnost je iznimno zahtjevan i dugotrajan proces. Od samog potpisivanja ugovora do isporuke plovila ključno je uskladiti mnoštvo čimbenika. Potrebno je osigurati novčana sredstva, ljudski potencijal, pripremiti dokumentaciju, rezervirati te naručiti materijal i brodsku opremu u skladu s zahtjevima naručitelja i tehnološkim mogućnostima brodogradilišta.

Od samog početka razvoja računala i računalnih programa, brodograđevna industrija nastoji što je više moguće uklopiti informatičke alate pri gradnji broda. U cilju bržeg i racionalnog postupka projektiranja modela i izrade tehnološke dokumentacije, računala i CAD/CAM sustavi imaju nezaobilaznu ulogu pri oblikovanju konačnog proizvoda.

U ovom Diplomskom radu izrađen je model sekcije nadgrađa broda za krstarenja, L394, GB730 te priprema radioničke i narudžbene dokumentacije. Radionička i narudžbena dokumentacija se sastoji od raskroja materijala, popisa elemenata konstrukcije i radioničkih nacрта i izvršena je upotrebom programa AVEVA Marine.

Ključne riječi: model broda, radionička dokumentacija, CAD/CAM sustavi, AVEVA Marine

SUMMARY

Ship production process is a complex and long-lasting manufacturing activity. From the first milestone till the ships delivery it is essential to harmonize many factors involved with the physical realization of the ship.

Constant ambition to ensure financial support, human potential, technical documentation, raw material and ship equipment in line with investors demands and technical capabilities of the shipyard.

From the beginning of CAM/CAD tools development, shipbuilding industry tends to implement sophisticated solutions as much as possible through all shipbuilding processes. The goal is to speed up the process of ships model creation, hull production documentation striving towards more efficient one with the main role of CAD/CAM tools. In this master thesis, hull production documentation and model for cruise ship L394, GB730 are provided using AVEVA Marine software.

Key words: ships model, hull construction documentation, CAD/CAM design, AVEVA Marine

1. UVOD

Brodograđevni proizvodni proces se sastoji od vremenskih i prostornih cjelina koje svojom interakcijom sudjeluju u razvojnim etapama koje će završiti fizičkom realizacijom broda. Nakon definiranja osnovnih karakteristika broda, pristupa se izradi koncepta kojim će se utvrditi cijena, rokovi, isplativost gradnje te kapaciteti brodogradilišta i ocijeniti tehnološkičnost projekta te potom krenuti s izradom detaljnog projekta.

Cilj ovog rada je izrada i priprema tehnološke dokumentacije koja ima ključnu ulogu tijekom faze detaljnog projektiranja broda i spona je između projektnih ureda i brodograđevnih radionica. Osim definiranja materijala potrebnih za izradu broda treba definirati tehnološku uputu kako i na kojem građevnom mjestu izraditi elemente brodske strukture. Kako se brodograđevni proces sastoji od niza podprocesa od kojih se priprema proizvodnje provlači kroz sve ključne faze, presudno je dovršiti izradu tehničke dokumentacije prije početka podprocesa obrade metalurgije trupa, [1].

1.1. Uporaba AVEVA Marine programskog alata

U ovom diplomskom radu će se prikazati razlozi i mogućnosti korištenja AVEVA Marine računalnog programa i njenih modula te će se isporučiti radionička dokumentacija i narudžbena specifikacija materijala za izgradnju jedne sekcije nadgrađa broda za krstarenja.

AVEVA Marine programski alat je tijekom godina svog razvoja prepoznat kao pouzdan i koristan alat te je implementiran u proizvodne sustave velikog broja najvećih svjetskih brodogradilišta. Hrvatska brodogradilišta se također okreću uporabi programa AVEVA Marine za izradu modela broda i pripremu radioničke i narudžbene dokumentacije. AVEVA marine program se sastoji od velikog broja modula od kojih su neki korišteni pri izradi ovog rada. Osnovni modul u kojem je izrađen modela broda se zove AVEVA Hull Detail Design. i pomoću njega se kreiraju radioničke liste potrebne za isporuku sekcija. Modul Automated Plate Nesting daje optimizirani raskroj materijala dok će nam modul AVEVA Marine Drafting poslužiti pri izradi radioničkih nacрта, Slika 1. Na samom kraju dati će se tehnološka uputa za izradu i predmontažu sklopova i sekcije.

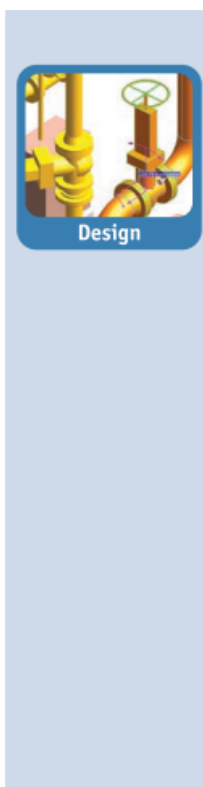
**AVEVA Hull Structural Design**

AVEVA Hull Structural Design™ is used for the preliminary definition and arrangement of the principal structure of a vessel. It enables production of classification drawings, early steel material estimates, weld lengths, and weight and centre of gravity reports.

AVEVA Hull Detailed Design

AVEVA Hull Detailed Design™ is used for the detailed design and creation of production information for the whole structure of a vessel. It handles the complete evolution and flow of information, from the use of customised parametric design standards, structural modelling and automatic parts generation, through to production information for parts manufacture. Output includes drawings, automatic sketches, parts lists, and numeric control information for production machines.

AVEVA Hull Finite Element Modeller

AVEVA Hull Finite Element Modeller™ allows Hull Structural Design users to perform a pre-mesh of the steel structure and to export this mesh in various formats to third-party Finite Element Analysis software for stress analysis. Model idealisation rules faithfully translate the hull structure into a high-quality, computationally efficient idealisation, while powerful configuration options ensure that even the most complex or unusual structure can be analysed with speed and accuracy.

AVEVA Outfitting

AVEVA Outfitting™ is a data-centric, multidisciplinary 3D design application for accurate and clash-free detailed design and the creation of production information for the outfitting data of ships and offshore vessels. Outfitting has modules for the design of equipment, piping, HVAC, miscellaneous steel structures and cable trays. Modelling is carried out in context, using a customer-defined catalogue and specification, in a full 3D environment, with the support of tools that ensure a clash-free design. A full range of outfitting drawings and production information can be produced automatically from the model.

AVEVA Marine Drafting

AVEVA Marine Drafting™ is a module for the automatic creation of symbolic-type marine drawings from the model database, as well as general 2D drafting functions.

AVEVA Outfitting Supports

AVEVA Outfitting Supports™ enables easy and efficient design of support for pipes, HVAC ducts and cable trays. It also generates Material Take Off and automatic drawing of supports sketches. It is specifically designed for Marine projects, with the most common standards easily accessible.

Slika 1. Moduli za rad u AVEVA Marine, [2]

2. IZRADA MODELA SEKCIJE NADGRADA PUTNIČKOG BRODA

2.1. Koncept definiranja sekcije i njenih sklopova

Struktura AVEVA Marine baze podataka unutar Hull Detail Design modula za svaki pojedini brod se sastoji od volumenskih blokova koji se prilagođavaju s veličinom sklopa. Unutar tog volumenskog bloka je definiran radni prostor potreban za izradu sekcije koja ne bi trebala izlaziti van tih granica, Slika 2.

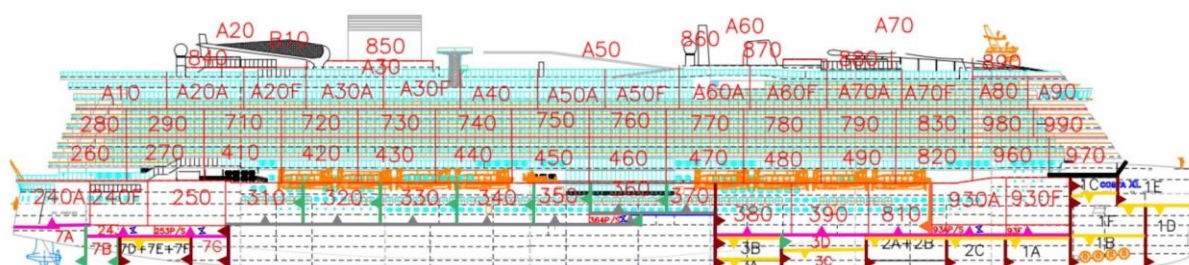

Slika 2. Podjela broda na blokove, [3]

Svaki grand blok je sastavljen od sekcija palube, pregrada ispod te palube i boka između dviju paluba, a daljnjom podjelom na sklopove i podsklopove (assembly) definiramo osnovnu građevnu jedinicu koji će predstavljati željenu, čeličnu konstrukciju. Prilikom definiranja sklopa potrebno je definirati granice svakog sklopa u ovisnosti o susjednim sklopovima. Oni tako postaju topološki ovisni jedni o drugima pa prilikom svake promjene granice pojedinog lima i preostala struktura se prilagođava zadanoj promjeni, [3]. Ovaj princip se ne odnosi samo na limove, već na sve elemente koji su sadržani u pojedinom sklopu (koljena, ukrepe, pločice).

2.2. Sučelje za definiranje modela sekcije i njenih sklopova

Prilikom modeliranja sklopa u programu AVEVA Marine, Slika 3, njegov jedinstveni naziv ne određuje samo geometrijski položaj panela, već i pripadnost tog panela svom bloku. U primjeru je prikazan kod jednog sklopa i sve informacije vezane za tu pregradu. Iz njega možemo isčitati, granice sklopa, debljinu i stranu na koju je okrenut materijal te samu kvalitetu materijala. Opisani su i ostali pripadni elementi sklopa. Ukrepe, koljena i pločice (njihov oblik, položaj, jedinstveni pozicijski broj i dimenzije).

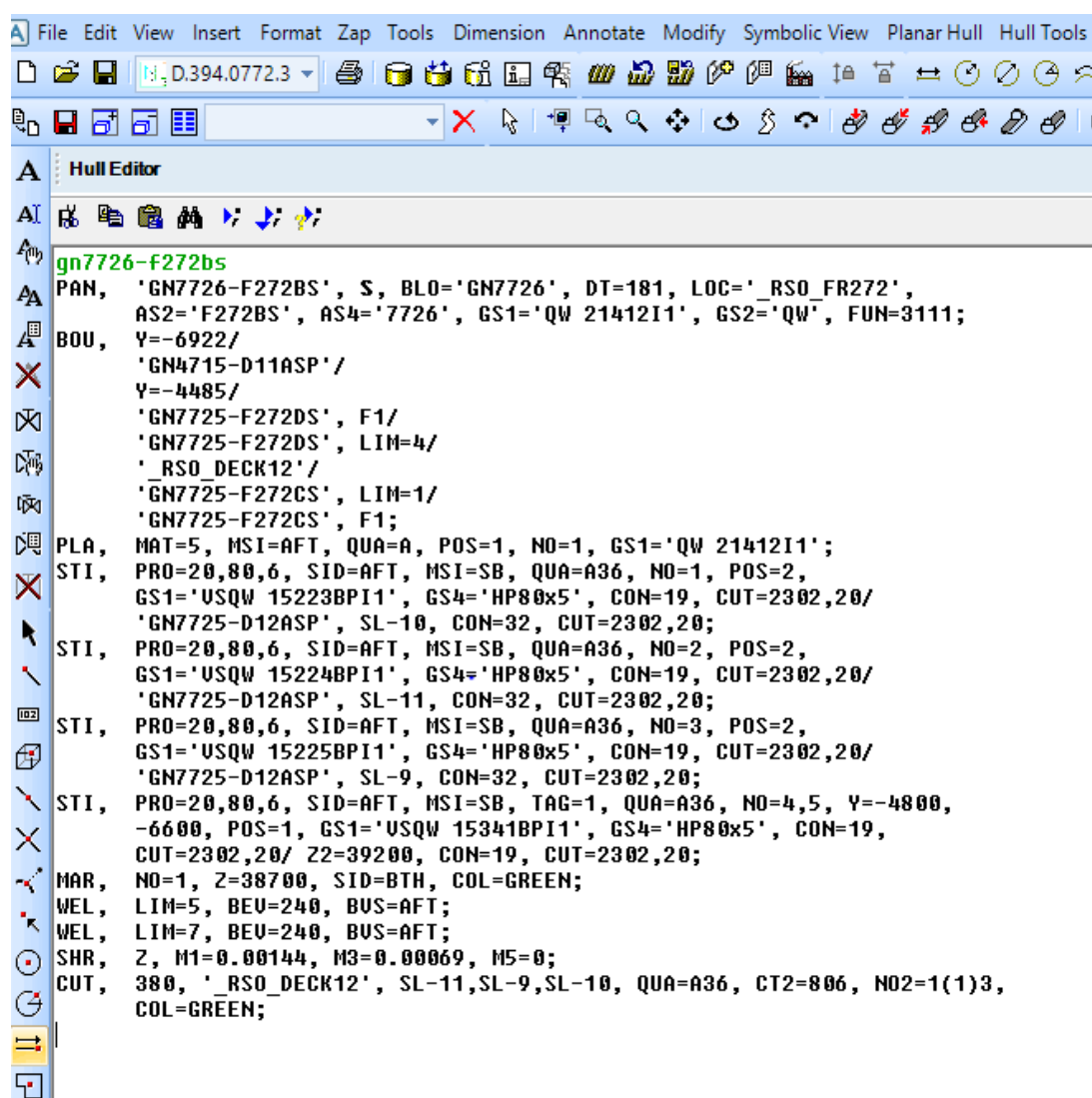

Slika 3. Sučelje za definiciju sklopa, [3]

Uvršten je dodatak za materijal *shr* (shrinkage), Tablica 1, čija vrijednost se mijenja u ovisnosti o debljini materijala, smjeru pružanja ukrepa na limu te načinu zavarivanja tih ukrepa (kontinuirani ili isprekidani zavar). Ako je pregrada vidljiva, zahtjev za površinskom obradom biti će uvršten.

Tablica 1. Dodatak za materijal, [4]

debljina lima <i>t</i> [mm]	dodatak za materijal, duljina pregrade, neprekinuti zavar, <i>shr</i>	dodatak za materijal, visina pregrade, neprekinuti zavar, <i>shr</i>	dodatak za materijal, duljina pregrade, isprekidani zavar, <i>shr</i>	dodatak za materijal, visina pregrade, isprekidani zavar <i>shr</i>
5,5-6,0	1,00155	1,00117	1,00144	1,00069
6,5-7,5	1,00146	1,00111	1,00134	1,00066
8,0-9,5	1,00133	1,00100	1,00119	1,00060
10,0-11,5	1,00117	1,00087	1,00102	1,00051
12,0-14,0	1,00099	1,00071	1,00089	1,00040
14,5-17,0	1,00079	1,00054	1,00074	1,00028
17,5-19,5	1,00054	1,00033	1,00055	1,00013
20,0-23,5	1,00037	1,00015	1,00039	1,00006
23,5-	1,00024	1,00008	1,00024	1,00003

Skošenja na rubovima lima i vrste šavova, Slika 4, su prilagođena osobinama (debljina lima i pripadnost istom ili različitom bloku ili sekciji) susjednih elemenata te mogućnostima panel linije na kojoj će se izvršiti okrupnjavanje sklopa. Oznaka GAP nam govori koliki je razmak između dva lima koje treba spojiti, a oznaka ALPHA predstavlja kut skošenja rubova lima. Simbol zastavice predstavlja vrstu šava koja se koristi samo na granicama između blokova.

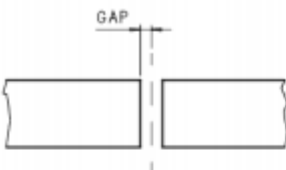
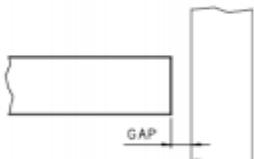
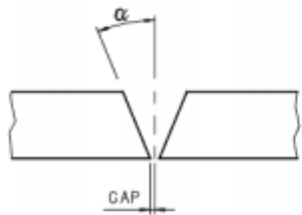
 <p>BEVEL TYPE = 10</p>	100 /GAP=0	(block limit symbol) ↗
	110 /GAP=0	
	107 /GAP=0.5	
	108 /GAP=0.75	
	101 /GAP=1	
	109 /GAP=1.5	
	102 /GAP=2	
 <p>BEVEL TYPE = 15</p>	150 /GAP=0	
	151 /GAP=1	
	152 /GAP=2	
	153 /GAP=3	
 <p>BEVEL TYPE = 20</p>	201 /GAP=0 /ALPHA=1	
	236 /GAP=0 /ALPHA=5	
	210 /GAP=0 /ALPHA=10	
	211 /GAP=0 /ALPHA=15	
	233 /GAP=0 /ALPHA=20	
	214 /GAP=0 /ALPHA=23	
	215 /GAP=0 /ALPHA=25	
	208 /GAP=0 /ALPHA=28	
	216 /GAP=0 /ALPHA=30	
	228 /GAP=0 /ALPHA=35	
	234 /GAP=0 /ALPHA=40	
	231 /GAP=0 /ALPHA=45	
	235 /GAP=0 /ALPHA=50	
	237 /GAP=0 /ALPHA=10	(block limit symbol)
	212 /GAP=0 /ALPHA=18	(block limit symbol)
	213 /GAP=0 /ALPHA=20	(block limit symbol)
	239 /GAP=0 /ALPHA=23	(block limit symbol)
	248 /GAP=0 /ALPHA=25	(block limit symbol)
	238 /GAP=0 /ALPHA=35	(block limit symbol)
	209 /GAP=0 /ALPHA=45	(block limit symbol)
	242 /GAP=0.5 /ALPHA=25	
	243 /GAP=0.5 /ALPHA=28	
	217 /GAP=1 /ALPHA=20	
	218 /GAP=1 /ALPHA=23	
	219 /GAP=1 /ALPHA=25	
	220 /GAP=1 /ALPHA=30	
221 /GAP=1 /ALPHA=35		
222 /GAP=1.5 /ALPHA=20		
223 /GAP=1.5 /ALPHA=23		
232 /GAP=2 /ALPHA=18		
247 /GAP=2 /ALPHA=23		
229 /GAP=2 /ALPHA=18	(subblock limit symbol)	
230 /GAP=2 /ALPHA=20	(subblock limit symbol)	
240 /GAP=2 /ALPHA=23	(subblock limit symbol)	
244 /GAP=2 /ALPHA=25		
245 /GAP=2 /ALPHA=28		
224 /GAP=3 /ALPHA=18		
225 /GAP=3 /ALPHA=20		
241 /GAP=3 /ALPHA=23		
246 /GAP=3 /ALPHA=28		
226 /GAP=3 /ALPHA=35		

Slika 4. Vrste zavora i popis šavova, [5]

Svaki element konstrukcije posjeduje funkcijski kod (uputu na kojoj proizvodnoj liniji će se izvršiti montaža). Na lim je stavljena markacija koja označava gornju stranu panela i pozicionirani su otvori kako bi se izvršila priprema za raskroj materijala. Svi sklopovi sa zajedničkim nazivom sekcije (assembly GPS4) čine jednu sekciju, Slika 5, i za nju se izrađuje potpuna radionička dokumentacija.

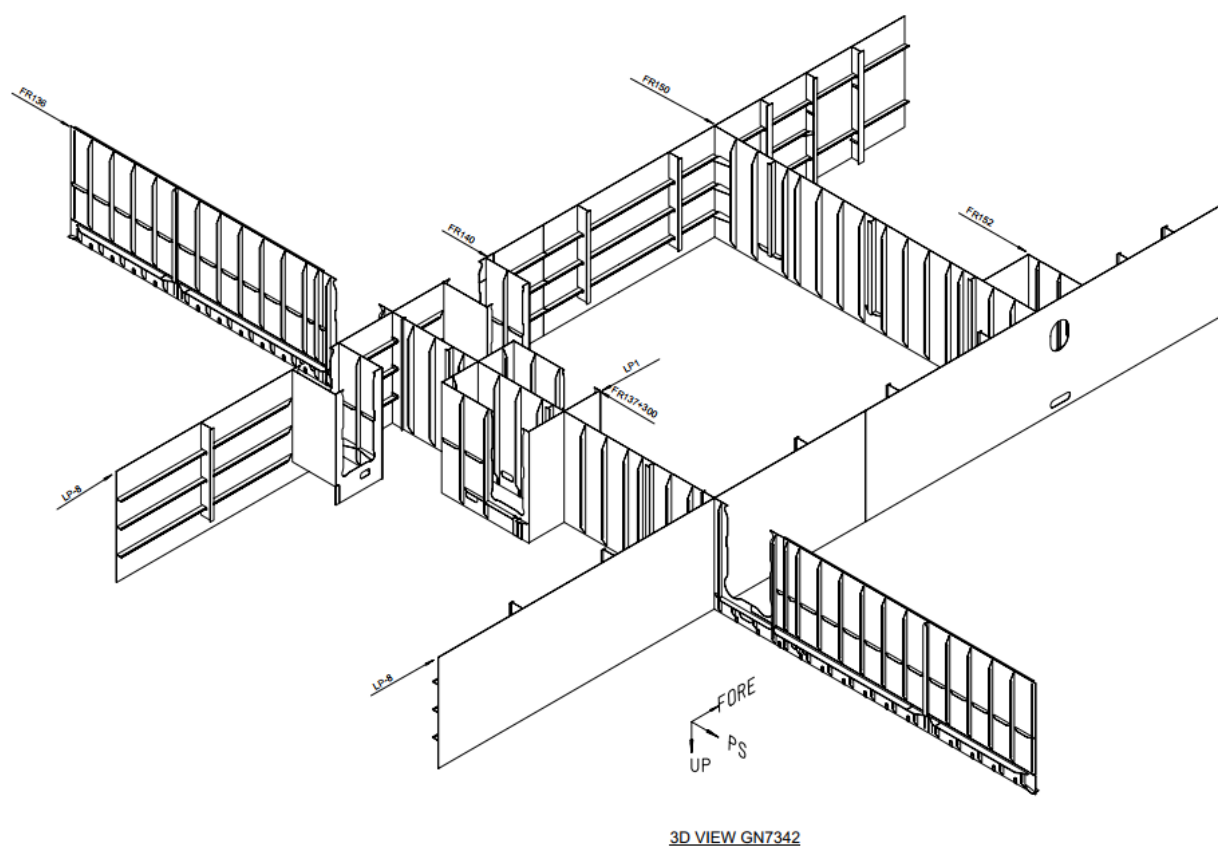

Slika 5. 3D model sekcije nadgrada GN7342, [5]

3. RASKROJ MATERIJALA I IZRADA RADIONIČKE I NARUDŽBENE SPECIFIKACIJE MATERIJALA

3.1. Tradicionalna metoda razvijanja lima

Tradicionalne metode razvijanja i trasiranja lima su bile dugotrajne i imale su više nedostataka. Crtanje se izvodilo u crtaonici u mjerilu 1:1, Slika 6. Potom bi se dobivena zakrivljena forma ispitala u bazenu uz nove korake korekcije brodskih linija pri formiranju građevnih rebara. Nakon razvoja vanjske oplata pristupalo bi se izradi drvenih letvica i šablona. Zadnji korak je bio obilježavanje limova i profila.

Nedostaci tradicionalne metode su se očitovali u individualnom ocijenjivanju glatkoće linija od strane crtača. U procesu prijenosa podataka između projektnog ureda gdje se stvaraju linije preko tablice očitavanja, teoretskih rebara, izrade građevinskih rebara u crtaonici mogle su se pojaviti pogreške. Sama procedura je trajala dugo, što je značilo da je limove trebalo naručiti prije gotovih očitavanja pa se trebao predvidjeti dodatak, povećati otpad i proizvodni troškovi. Podaci dobiveni iz crtaonice se nisu mogli direktno koristiti u numerički upravljanim strojevima što je bio najveći nedostatak, [6]. Ova procedura je zahtijevala velike radne prostore za crtanje i izradu šablona i obilježavanje limova.



Slika 6. Trasiranje lima, [7]

3.2. Raskroj materijala

Prilikom modeliranja bloka AVEVA Marine bloka, a prije operacije raskroja potrebno je još jednom usporediti dimenzije i kvalitetu limova i profila sa stvarnim mogućnostima narudžbe iz valjaonice limova. Ako ponuđeni izbor limova i profila ne zadovoljava zahtjeve konstrukcije, model će se morati prilagoditi odabirom limova i profila veće dimenzije i iste kvalitete ili jednake dimenzije, ali veće kvalitete materijala kako bi se zadovoljila čvrstoća konstrukcije. Popis limova i profila koji se nalaze na skladištu Meyer Turku, Tablica 2 i Tablica 3.

Tablica 2. Limovi na skladištu, [8]

Debljina t [mm]	kvaliteta	Visina H [mm]	Duljina L [mm]	R_e [mm]
5	A	2750	9000	235
5	A	2750	12000	235
5	A	2850	12000	235
5	A	3000	9000	235
5	A	3000	12000	235
5	A	3250	12000	235
6	A	2750	9000	235
6	A	2750	12000	235
6	A	3050	12000	235
7	A	2750	9000	235
7	A	2750	12000	235
7	A	2900	12050	235
7	A	3000	12000	235
7	A	3250	12000	235
8	A	2900	12000	235
8	A	3000	9000	235
8	A	3000	12000	235
9	A	3000	12000	235
10	A	2900	7000	235
10	A	2900	12000	235
10	A	3050	12000	235
12	A	3000	12000	235
12.5	A	3000	12000	235
13	A	3000	12000	235
13.5	A	3000	12000	235
14	A	3000	12000	235
15	A	3050	8000	235

15	A	3050	12000	235
15.5	A	3050	12000	235
16	A	3000	12000	235
16.5	A	3000	12000	235
17	A	3000	12000	235
18	A	3000	12000	235
20	A	3000	12000	235
22	A	3000	12000	235
25	A	3000	12000	235
30	A	3000	12000	235
40	A	3000	12000	235
6	A36	3000	12000	315
7	A36	2750	9000	315
7	A36	2750	12000	315
7	A36	3000	9000	315
7	A36	3000	12000	315
7	A36	3250	12000	315
8	A36	3000	9000	315
8	A36	3000	12000	315
10	A36	2750	9000	315
10	A36	2750	12000	315
10	A36	2850	9000	315
10	A36	2850	12000	315
10	A36	3000	9000	315
10	A36	3000	12000	315
10	A36	3250	12000	315
12	A36	2750	9000	315
12	A36	2750	12000	315
12	A36	2850	12000	315
12	A36	3000	12000	315
13	A36	1800	12000	315
13	A36	2850	9000	315
14	A36	2650	12000	315
14	A36	2750	9000	315
14	A36	2750	12000	315
14	A36	3000	9000	315
14	A36	3000	12000	315
14	A36	3250	12000	315
15	A36	3000	12000	315
16	A36	3000	12000	315
16	A36	3200	12000	315
18	A36	2850	12000	315
18	A36	3050	9000	315
18	A36	3050	12000	315

19	A36	3050	12000	315
20	A36TM	3000	12000	355
21	A36TM	3000	12000	355
25	A36TM	3000	12000	355
30	A36TM	3000	12000	355
40	A36TM	3000	12000	355
25	D36TM	3000	12000	355
30	D36TM	3000	12000	355
40	E40TM	2050	6000	390
50	E40TM	2050	6000	390

Tablica 3. Profili na skladištu, [8]

Ravni profili	Holland profili	Cijevni profili
B [mm], t [mm], l [mm]	h [mm], t [mm], l [mm]	ϕ [mm], t [mm], l [mm]
A LAT 70*15*6000	A BE 180*8*12000	S355J2H PUT 76,1*6,3*1000
A LAT 80*8*6000	A BE 180*10*12000	S355J2H PUT 139.7*8*1000
A LAT 80*15*6000	A BE 200*10*12000	S355J2H PUT 139.7*10*1000
A LAT 100*8*12000	A BE 200*9*12000	S355J2H PUT 168.3*10*1000
A LAT 100*10*12000	A BE 220*10*12000	S355J2H PUT 168.3*14.2*1000
A LAT 100*15*12000	A BE 240*10*12000	S355J2H PUT 168.3*20*1000
A LAT 120*8*12000	A BE 240*12*12000	S355J2H PUT 168.3*25*1000
A LAT 150*10*12000	A BE 260*12*12000	S355J2H PUT 168.3*35*1000
A LAT 150*15*12000	A BE 280*12*12000	S355J2H PUT 193.7*12.5*1000
A LAT 150*20*12000	A BE 300*12*12000	S355J2H PUT 193.7*14.2*1000
A LAT 200*10*12000	A BE 320*12*12000	S355J2H PUT 193.7*20*1000
A LAT 200*15*12000	A BE 340*12*12000	S355J2H PUT 193.7*25*1000
A LAT 200*20*12000	A BE 370*13*12000	S355J2H PUT 193.7*40*1000
A LAT 250*15*12000	A36 BE 80*5*12000	S355J2H PUT 219.1*14.2*1000
A LAT 250*20*12000	A36 BE 80*6*12000	S355J2H PUT 219.1*17.5*1000
A36 LAT 40*10*6000	A36 BE 100*5*12000	S355J2H PUT 219.1*20*1000
A36 LAT 50*10*6000	A36 BE 100*5*11000	S355J2H PUT 219.1*25*1000
A36 LAT 100*5*12000	A36 BE 120*6*12000	S355J2H PUT 219.1*40*1000
A36 LAT 100*8*12000	A36 BE 120*7*12000	S355J2H PUT 244.5*20*1000
A36 LAT 100*10*12000	A36 BE 120*8*12000	S355J2H PUT 244.5*25*1000
A36 LAT 120*10*12000	A36 BE 140*8*12000	S355J2H PUT 244.5*36*1000
A36 LAT 150*10*12000	A36 BE 160*8*12000	S355J2H PUT 273*20*1000
A36 LAT 150*15*12000	A36 BE 160*9*12000	S355J2H PUT 273*25*1000
A36 LAT 200*15*12000	A36 BE 180*8*12000	S355J2H PUT 323,9*25*1000
	A36 BE 180*10*12000	

Završetkom faze modeliranja i zadavanjem pozicijskih brojeva za svaki element konstrukcije potrebno je razraditi model do pojedinačnih elemenata. AVEVA Marine to čini programom koji se zove Plate Parts Generations Program. Ovaj program razdvaja sve limove i profile koji zajedno tvore jedan sklop (assembly) i stvara bazu podataka koja se sastoji od (GEN) file dokumenata (lista za rezanje limova koja se automatski generira razradom do pojedinačnih elemenata), prilog I, a koji su zapravo uputa stroju kako raskrojiti materijal.

Na slijedećem primjeru je prikazan raskroj, Slika 7, pregrada ispod palube na naručenom limu. Prikazane su njihove dimenzije kao i dimenzija i karakteristike naručenog lima (debljina, širina, visina, masa i kvaliteta materijala). Na raskroju svakog sklopa postavljene su markacije za profile, markacija za gornju stranu lima, vrsta skošenja rubova, kvaliteta završne obrade te naravno jedinstveno ime tog sklopa. Sadržana je uputa za vrstu zavora (kontinuirani ili isprekidani zavar) profila na limove u odnosu na položaj koji pregrada zauzima u konstrukciji broda.

Na ovom raskroju udio neiskorištene površine naručenog lima iznosi 17.6%. Taj ostatak materijala će se iskoristiti za manje elemente konstrukcije (koljena, pločice, zakrpe) u izradi neke slijedeće sekcije. Prikazi raskroja za sekciju GN7342 se nalaze u prilogu II.

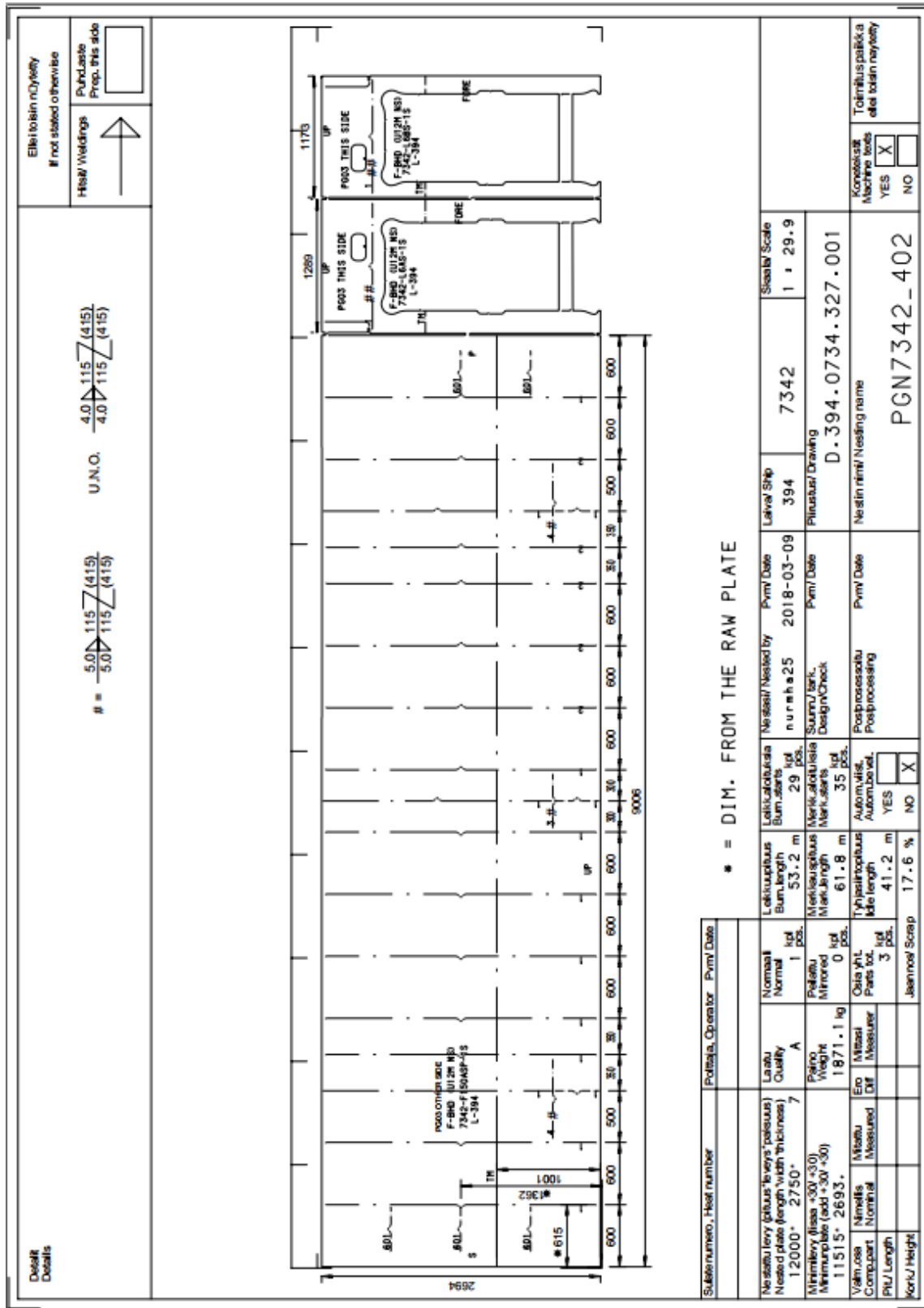

Slika 7. Raskroj materijala, [5]

3.3. Okrupnjavanje limova palube

Kako bi se izvršilo spajanje u jedan jumbo panel palube (plate gathering), a čija se duljina i širina podudara s veličinom bloka potrebno je izraditi upute za rezanje i pripremiti rubove svakog lima. Dimenzije naručenih limova palube se trebaju prilagoditi zahtjevanim dimenzijama limova koje se mogu očitati iz pripremljenog modela.

Na nacrtu upute za rezanje limova, Slika 8, svaki lim ima svoj naziv, pozicijski broj i oznaku kojem bloku i jumbo panelu pripada. Naznačena je kvaliteta, debljina materijala i dimenzija naručenog lima. Postavljene su oznake za skošenje rubova panela i skica detalja kako se priprema ruba treba izvršiti. Definirana je orijentacija panela i proizvodna dimenzija, ona na koju će se lim izrezati.

Odabir pozicije šavova definirati će minimalna udaljenost od 50 mm od bilo koje ukrepe zavarene na limove palube i izbjegavanje prelaženja šavova na radijusima otvora koje je potrebno iskrojiti. Minimalni razmak šavova između limova palube je definiran tehnološkim mogućnostima pa minimalna širina lima koji se može naručiti iznosi 1750 mm, a maksimalna širina iskrojenog lima palube mora biti 50 mm manja od širine naručenog lima, [9].

U ovisnosti o položaju lima u odnosu na okrupljeni panel, razlikovati će se i razlike rezerve materijala potrebne kako bi se limovi sveli na željenu mjeru. Vanjski limovi, Slika 9, koji su označeni pozicijskim brojevima 1 i 4 imati će višak od 15 mm zbog potrebe pripreme vanjskih rubova i uklapanja sekcije sa sekcijom oplata broda, dok će se unutarnji limovi (pozicijski brojevi 2 i 3) podudarati s dimenzijom limova koja je definirana s dodatkom za materijal, Tablica 1, u AVEVA Marine modelu. Nacrta raskroja limova palube i nacrt spajanja u jedan jumbo panel zvat će se GAT nacrti, prilog III, i biti će dio isporuke radioničke dokumentacije za sekciju GN7341.

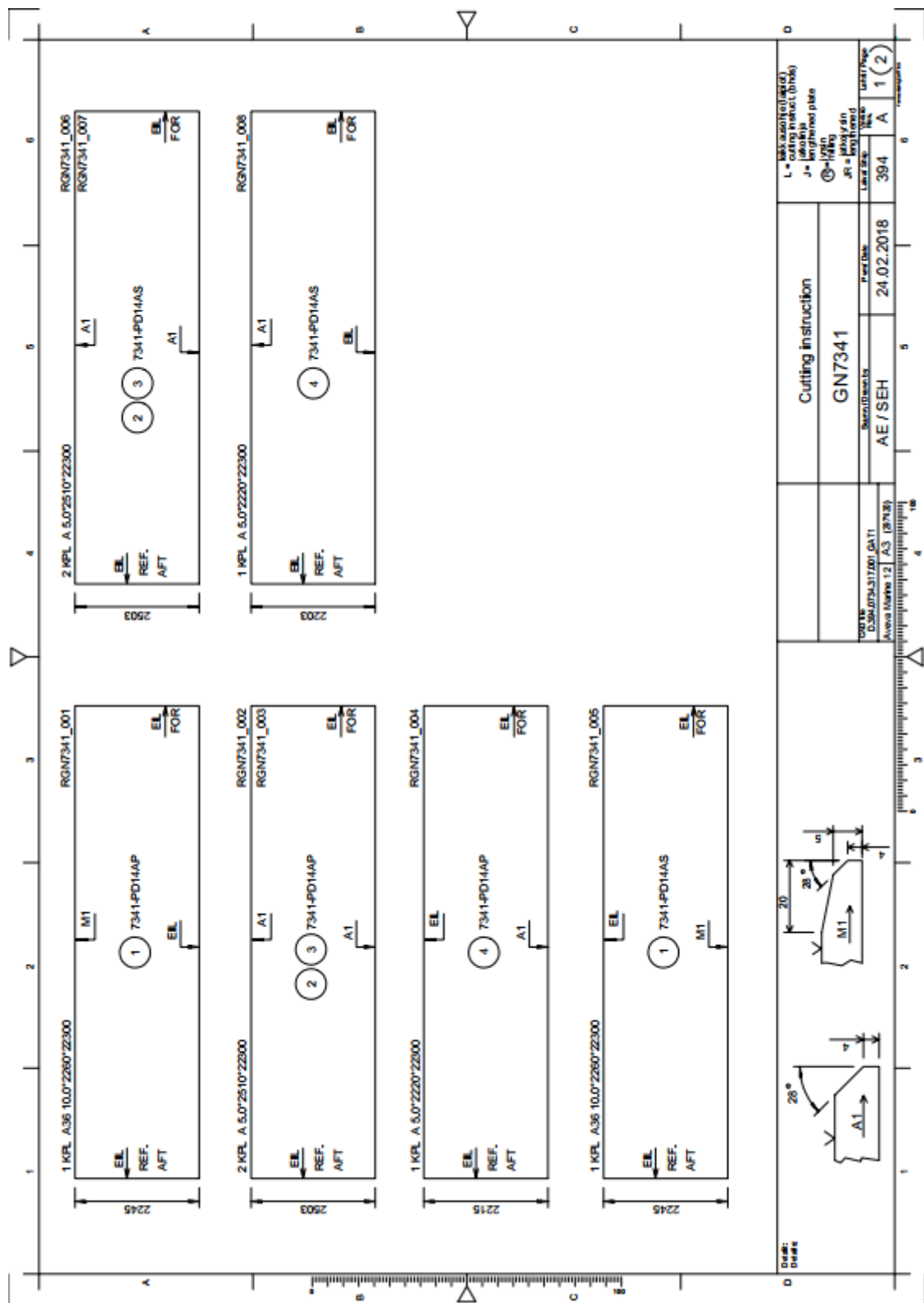

Slika 8. Raskroj limova palube, [5]

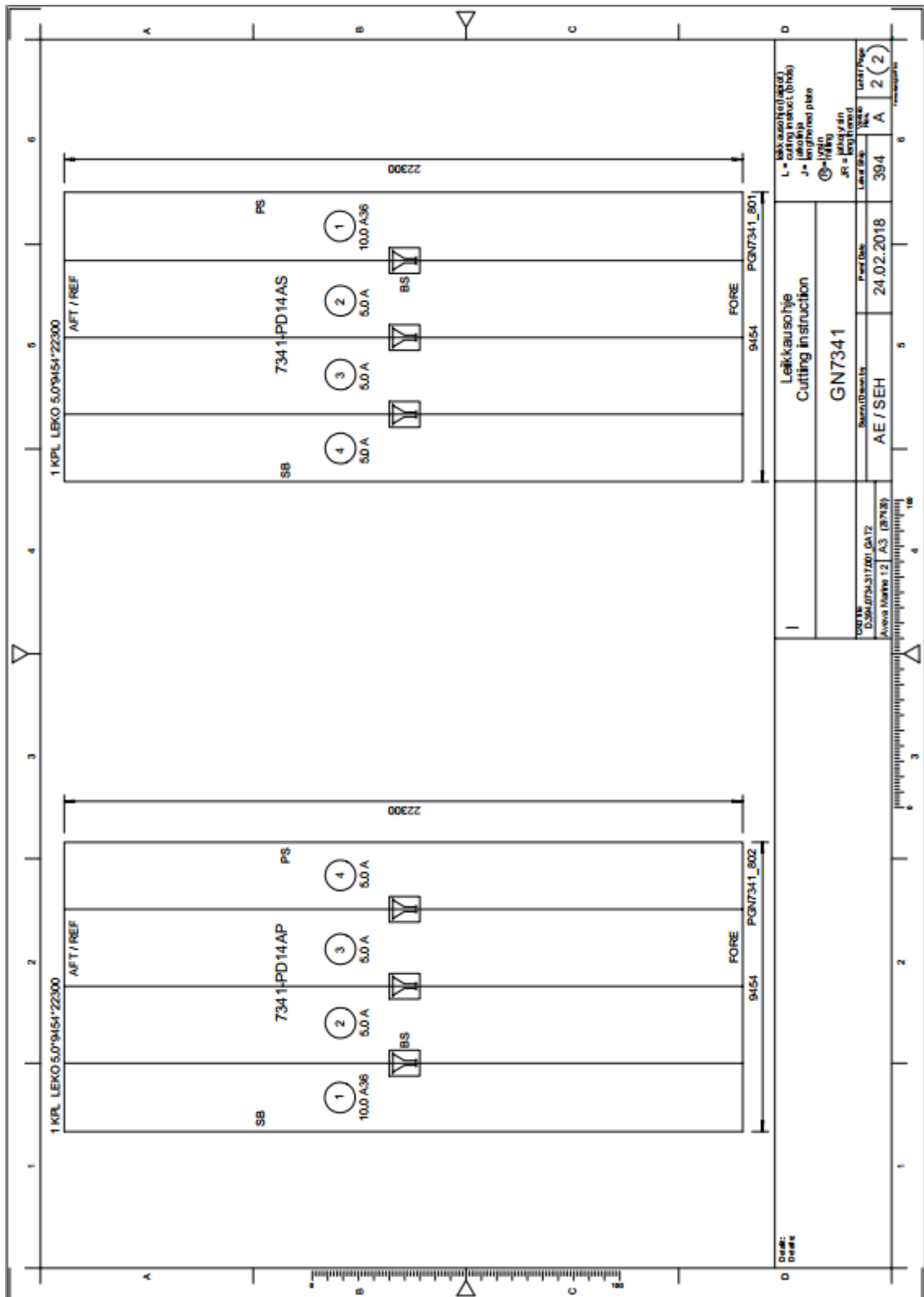

Slika 9. Spajanje limova palube, [5]

3.4. Izrada radioničke specifikacije materijala

Radionička i narudžbena specifikacija materijala se izrađuje za svaku sekciju posebno. Kako se svaki blok sastoji od sekcije palube, sekcije pregrada ispod te palube i oplate broda tako će svaka sekcija imati potpunu, vlastitu dokumentaciju.

GEN datoteka je uputa stroja kako će se izvršiti raskroj svakog naručenog lima.

Wcog-lista, prilog IV, se sastoji od svih elemenata koji se nalaze u pojedinoj sekciji. Popis limova, prilog V, je popis standardnih dijelova i elemenata koji će otići na raskroj materijala. Popis profila, prilog VI, je lista upotrijebljenih profila sa uputama za vrste skošenja krajeva profila.

U primjeru, prilog IV, wcog liste za sekciju GN7342 svaki element je pojedinačno definiran sa svojim geometrijskim i tehnološkim značajkama.

Jedna od prednosti korištenja suvremenih alata je i poznat točan položaj težišta svakog bloka kao i njegova masa (bez opreme) što se može očitati iz wcog-liste jer u AVEVA Marine modelu broda svaki element mora imati definiran položaj u prostoru, dimenzije i vrstu materijala od koje je izrađen. Na taj način se može usporediti masa sekcije u modelu s pretpostavljenom masom sekcije koja služi i kao okvir pri izračunu sati potrebnih za izradu modela sekcije. Poznavajući masu sekcije možemo planirati transportne aktivnosti i način na koji ćemo okretati sekcije prilikom montaže na grand blok.

U fazi pripreme izrade dijelova sekcije, korištenjem detaljnih listi radioničkih specifikacija materijala potrebno je još jednom provjeriti da li su svi elementi sadržani na popisu (pripadaju li ispravnom bloku) te da li imaju nedvosmisleni i ispravan naziv te hoće li završiti na željenoj proizvodnoj liniji.

Uporabom funkcijskog koda u modeliranju svakog sklopa, izrađujemo uputu na kojoj proizvodnoj liniji predmontaže će se izvršiti montaža sklopa u ovisnosti o vrsti sklopa.

Odabir funkcijskog koda za limove sa šavovima, Slika 10, je definiran:

- debljinom lima
- duljinom lima
- postojanjem šava
- postojanjem ukrepljenja
- orijentacijom ukrepa
- visinom lima

Svi elementi konstrukcije koji su povezani u jedan sklop uz zajednički naziv sklopa moraju posljedično imati i zajednički funkcijski kod.

Bulkheads with seam/s

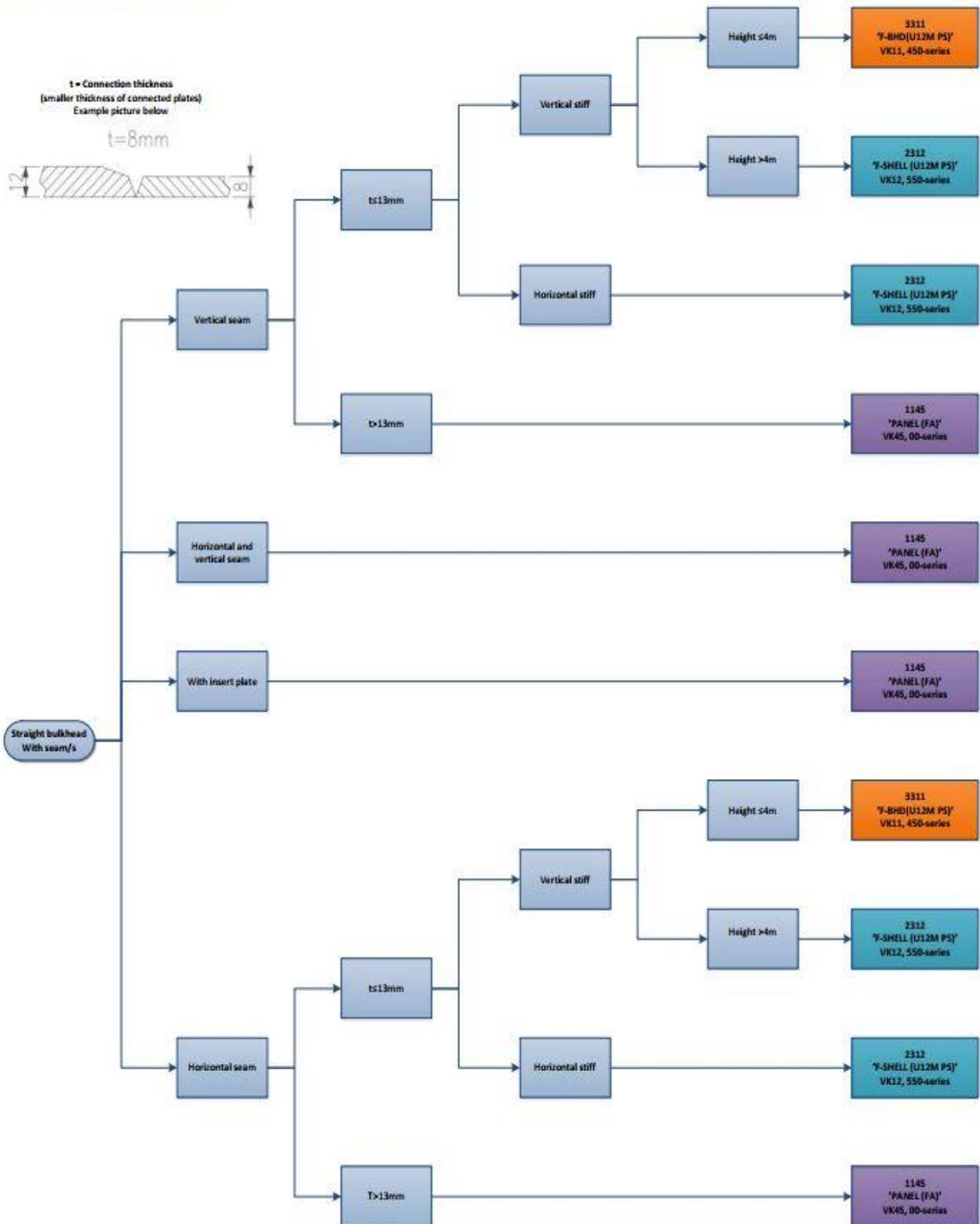

Slika 10. Odabir funkcijskog koda, [9]

Ako panelu odaberemo funkcijski kod 3311, Slika 10, znači kako karakteristike tog sklopa moraju zadovoljavati ograničenja i mogućnosti koja posjeduje proizvodna linija u hali 11, Meyer Turku, u kojoj će se izvršiti montaža. Linija predmontaže sklopova, Slika 11, u hali 11. može sastavljati limove s vertikalnim šavovima, visinom do 4 m, duljinom do 12 m i debljinom do 13 mm [3]. Ukrepe se zavaruju kontinuiranim zavarom EPP postupkom.

Završnom usporedbom liste limova i radioničkih nacrti raskroja limova provjeriti će se jesu li svi elementi konstrukcije koji se nalaze na listi limova zaista i prisutni u nacrtima raskroja materijala i završiti u proizvodnji.



Slika 11. Linija za predmontažu sklopova Meyer Turku, [9]

3.5. Izrada narudžbene specifikacije materijala

Narudžbena specifikacija materijala će se sastojati od popisa konačnog broja limova i profila koji će se iskoristiti prilikom gradnje sekcije.

Popis limova sadrži ključne informacije vezane za narudžbu. Zahtjevane dimenzije svakog pojedinog lima, njegovu kvalitetu, masu, količinu naručenih limova te informaciju za koji raskroj će se svaki lim iskoristiti.

Brodogradilište će u svakoj prilici nastojati iskoristiti limove koji su već djelomično utrošeni za neku prijašnji blok ili novogradnju. Raskroj PGN7342_404, Slika 12, je primjer raskroja koji će se napraviti s ostatkom već naručenog lima (napomena za korištenje 'rest plate' prisutna u nacrtu raskroja materijala) kako bi se optimizirala količina novo naručenih limova, Tablica 4. Posao rezerviranja novih limova obavit će koordinator u brodogradilištu po primitku zahtjeva od strane konstruktora trupa broda.

Tablica 4. Narudžbeni popis limova za sekciju GN7342

Popis materijala - Limovi				
Brod	1394			
Blok	GN7342			
Potpis:	matisa11			
Ime raskroja	Kol.	Dimenzije L[mm], H[mm], t[mm]	Kvaliteta	Masa [kg]
PGN7342_451	1	9000*2750*6.0	A	1203
PGN7342_452	1	9000*2750*6.0	A	1203
KGN7342_001	1	515*140*7.0	A	4
PGN7342_404	1	2485*2265*7.0	A	319
PGN7342_401	1	12000*2750*7.0	A	1871
PGN7342_402	1	12000*2750*7.0	A	1871
PGN7342_403	1	12000*2750*7.0	A	1871
PGN7342_301	1	9000*3000*8.0	A	1750
PGN7342_001	1	275*215*8.0	A36	4
KGN7342_002	1	480*315*8.0	A36	7
PGN7342_453	1	9000*2750*10.0	A36	2005
PGN7342_501	1	12000*2750*10.0	A36	2673
PGN7342_502	1	12000*2750*10.0	A36	2673
PGN7342_503	1	12000*2750*10.0	A36	2673
PGN7342_504	1	12000*2750*10.0	A36	2673
PGN7342_002	1	430*545*20.0	A36TM	38

Korištenjem AVEVA Marine modula 'Plane Parts Generation Program' izraditi će se lista svih profila koji se potom kombiniraju s maksimalnom duljinom profila koji se mogu naručiti kako bi se što bolje iskoristio materijal.

Iz liste raskroja profila za sekciju GN7342 izdvojeni su HP 100x5 A36 profili koji osim jedinstvenog naziva i pozicijskog broja svakog profila pružaju informacije o duljini pojedinog profila kao i podatak o akumuliranoj duljini te neiskorištenom ostatku od ukupne duljine jednog profila duljine 12000 mm.

Za potrebe sekcije GN7342 iskoristiti će se tako devet profila HP 100x5 A36 duljine 12000 mm, Tablica 5. Udio neiskorištenog ostatka od ukupne duljine svih devet profila HP 100x5 A36 iznositi će 8.2%.

Nested Profile List 2018-05-09

GN7342_20 MANUAL Material: BE-100X5_A36(Length: 12000)

1 GN7342-F136BS/S30S (7342-F136BS13S)	Len.: 2614	Acc. Len.: 2624
2 GN7342-F136BP/S30P (7342-F136BP9P)	Len.: 2614	Acc. Len.: 5248
3 GN7342-X138AS/S1S (7342-X138AS3S)	Len.: 2613	Acc. Len.: 7871
4 GN7342-X137ASP/S3S (7342-X137ASP3S)	Len.: 2613	Acc. Len.: 10495
5 GN7342-F136BS/S3S (7342-F136BS23S)	Len.: 419	Acc. Len.: 10923
6 GN7342-F136BP/S54P (7342-F136BP20P)	Len.: 419	Acc. Len.: 11352
7 GN7342-F136BS/S49S (7342-F136BS24S)	Len.: 355	Acc. Len.: 11716
8 GN7342-F136BS/S53S (7342-F136BS22S)	Len.: 269	Acc. Len.: 11996
Used Length: 11996	Rest Length: 4	(0.0%)

Nested Profile List 2018-05-09

GN7342_21 MANUAL Material: BE-100X5_A36(Length: 12000)

1 GN7342-X137ASP/S2S (7342-X137ASP3S)	Len.: 2613	Acc. Len.: 2623
2 GN7342-X135ASP/S3S (7342-X135ASP3S)	Len.: 2613	Acc. Len.: 5247
3 GN7342-X135ASP/S2S (7342-X135ASP3S)	Len.: 2613	Acc. Len.: 7870
4 GN7342-X133AS/S1S (7342-X133AS3S)	Len.: 2613	Acc. Len.: 10494
5 GN7342-F136BS/S48S (7342-F136BS24S)	Len.: 355	Acc. Len.: 10858
6 GN7342-F136BS/S47S (7342-F136BS24S)	Len.: 355	Acc. Len.: 11223
7 GN7342-F136BS/S46S (7342-F136BS24S)	Len.: 355	Acc. Len.: 11588
8 GN7342-F136BS/S45S (7342-F136BS24S)	Len.: 355	Acc. Len.: 11952
Used Length: 11957	Rest Length: 43	(0.4%)

Nested Profile List 2018-05-09

GN7342_22 MANUAL Material: BE-100X5_A36(Length: 12000)

1 GN7342-L4BS/S1S (7342-L4BS3S)	Len.: 2613	Acc. Len.: 2623
2 GN7342-L4AS/S2S (7342-L4AS3S)	Len.: 2613	Acc. Len.: 5247
3 GN7342-L1BP/S1P (7342-L1BP3P)	Len.: 2613	Acc. Len.: 7870
4 GN7342-L1AP/S1P (7342-L1AP3P)	Len.: 2613	Acc. Len.: 10494
5 GN7342-F136BS/S44S (7342-F136BS24S)	Len.: 355	Acc. Len.: 10858
6 GN7342-F136BS/S43S (7342-F136BS24S)	Len.: 355	Acc. Len.: 11223
7 GN7342-F136BS/S25S (7342-F136BS24S)	Len.: 355	Acc. Len.: 11588
8 GN7342-F136BP/S53P (7342-F136BP21P)	Len.: 355	Acc. Len.: 11952
Used Length: 11957	Rest Length: 43	(0.4%)

Nested Profile List 2018-05-09

GN7342_23 MANUAL Material: BE-100X5_A36(Length: 12000)

1 GN7342-F136BS/S50S (7342-F136BS5S)	Len.: 2195	Acc. Len.: 2205
2 GN7342-F136BP/S1P (7342-F136BP4P)	Len.: 2195	Acc. Len.: 4410
3 GN7342-F136BS/S19S (7342-F136BS4S)	Len.: 2178	Acc. Len.: 6598
4 GN7342-F136BS/S10S (7342-F136BS4S)	Len.: 2178	Acc. Len.: 8787
5 GN7342-F136BS/S9S (7342-F136BS2S)	Len.: 2163	Acc. Len.: 10960
6 GN7342-F136BP/S50P (7342-F136BP21P)	Len.: 355	Acc. Len.: 11324
7 GN7342-F136BP/S49P (7342-F136BP21P)	Len.: 355	Acc. Len.: 11689
8 GN7342-F136BS/S52S (7342-F136BS22S)	Len.: 269	Acc. Len.: 11968
Used Length: 11973	Rest Length: 27	(0.2%)

Nested Profile List 2018-05-09

GN7342_24 MANUAL Material: BE-100X5_A36(Length: 12000)

1 GN7342-F136BS/S8S (7342-F136BS2S)	Len.: 2163	Acc. Len.: 2173
2 GN7342-F136BS/S7S (7342-F136BS2S)	Len.: 2163	Acc. Len.: 4346
3 GN7342-F136BS/S6S (7342-F136BS2S)	Len.: 2163	Acc. Len.: 6519
4 GN7342-F136BS/S5S (7342-F136BS2S)	Len.: 2163	Acc. Len.: 8692
5 GN7342-F136BS/S4S (7342-F136BS2S)	Len.: 2163	Acc. Len.: 10866
6 GN7342-F136BP/S48P (7342-F136BP21P)	Len.: 355	Acc. Len.: 11230
7 GN7342-F136BP/S47P (7342-F136BP21P)	Len.: 355	Acc. Len.: 11595
8 GN7342-F136BP/S46P (7342-F136BP21P)	Len.: 355	Acc. Len.: 11959
Used Length: 11964	Rest Length: 36	(0.3%)

Nested Profile List 2018-05-09

GN7342_25 MANUAL Material: BE-100X5_A36(Length: 12000)

1 GN7342-F136BS/S29S (7342-F136BS2S)	Len.: 2163	Acc. Len.: 2173
2 GN7342-F136BS/S28S (7342-F136BS2S)	Len.: 2163	Acc. Len.: 4346
3 GN7342-F136BS/S27S (7342-F136BS2S)	Len.: 2163	Acc. Len.: 6519
4 GN7342-F136BP/S9P (7342-F136BP2P)	Len.: 2163	Acc. Len.: 8692
5 GN7342-F136BP/S8P (7342-F136BP2P)	Len.: 2163	Acc. Len.: 10866
6 GN7342-F136BP/S44P (7342-F136BP21P)	Len.: 355	Acc. Len.: 11230
7 GN7342-F136BP/S43P (7342-F136BP21P)	Len.: 355	Acc. Len.: 11595
8 GN7342-F136BP/S42P (7342-F136BP21P)	Len.: 355	Acc. Len.: 11959
Used Length: 11964	Rest Length: 36	(0.3%)

Nested Profile List 2018-05-09

GN7342_26 MANUAL Material: BE-100X5_A36(Length: 12000)

1 GN7342-F136BP/S7P (7342-F136BP2P)	Len.: 2163	Acc. Len.: 2173
2 GN7342-F136BP/S3P (7342-F136BP2P)	Len.: 2163	Acc. Len.: 4346
3 GN7342-F136BP/S2P (7342-F136BP2P)	Len.: 2163	Acc. Len.: 6519
4 GN7342-F136BP/S29P (7342-F136BP2P)	Len.: 2163	Acc. Len.: 8692
5 GN7342-F136BP/S14P (7342-F136BP2P)	Len.: 2163	Acc. Len.: 10866
6 GN7342-F136BP/S41P (7342-F136BP21P)	Len.: 355	Acc. Len.: 11230
7 GN7342-F136BP/S40P (7342-F136BP21P)	Len.: 355	Acc. Len.: 11595
8 GN7342-F136BP/S39P (7342-F136BP21P)	Len.: 355	Acc. Len.: 11959
Used Length: 11964	Rest Length: 36	(0.3%)

Nested Profile List 2018-0-09

GN7342_27 MANUAL Material: BE-100X5_A36(Length: 12000)

1 GN7342-F136BP/S13P (7342-F136BP2P)	Len.: 2163	Acc. Len.: 2173
2 GN7342-F136BP/S12P (7342-F136BP2P)	Len.: 2163	Acc. Len.: 4346
3 GN7342-F136BP/S11P (7342-F136BP2P)	Len.: 2163	Acc. Len.: 6519
4 GN7342-F136BP/S10P (7342-F136BP2P)	Len.: 2163	Acc. Len.: 8692
5 GN7342-F140AS/S1S (7342-F140AS1S)	Len.: 2153	Acc. Len.: 10855
6 GN7342-F136BS/S39S (7342-F136BS24S)	Len.: 355	Acc. Len.: 11220
7 GN7342-F136BS/S38S (7342-F136BS24S)	Len.: 355	Acc. Len.: 11584
8 GN7342-F136BS/S37S (7342-F136BS24S)	Len.: 355	Acc. Len.: 11949
Used Length: 11954	Rest Length: 46	(0.4%)

Nested Profile List 2018-05-09

GN7342_28 MANUAL Material: BE-100X5_A36(Length: 12000)

1	GN7342-F132AS/S1S (7342-F132AS1S)	Len.: 2153	Acc. Len.: 2163
2	GN7342-F136BS/S26S (7342-F136BS24S)	Len.: 355	Acc. Len.: 2527
3	GN7342-F136BP/S36P (7342-F136BP18P)	Len.: 269	Acc. Len.: 2807
4	GN7342-F136BP/S37P (7342-F136BP18P)	Len.: 269	Acc. Len.: 3086
5	GN7342-F136BP/S38P (7342-F136BP19P)	Len.: 264	Acc. Len.: 3361
Used Length: 3366		Rest Length: 8634	(72.0%)

Summary of Material Used 2018-05-09

Tablica 5. Narudžbena lista profila za sekciju GN7342

Kol.	Vrsta profila	Ukupna duljina /[mm]	Iskorištena duljina /[mm]	Ostatak
9	BE-100X5_A36	Ukupno: 108000	Iskorišteno: 99094	Neiskorišteno: 8.2 %
5	LAT-100X10_A	Ukupno: 60000	Iskorišteno: 48615	Neiskorišteno: 19 %
1	LAT-120X10_A	Ukupno: 12000	Iskorišteno: 3060	Neiskorišteno: 74.5 %
1	LAT-150X10_A	Ukupno: 12000	Iskorišteno: 8106	Neiskorišteno: 32 %
2	LAT-150X15_A	Ukupno: 24000	Iskorišteno: 16383	Neiskorišteno: 31.7 %
1	LAT-50X10_A36	Ukupno: 6000	Iskorišteno: 1757	Neiskorišteno: 70,7 %
4	LAT-50X6_A	Ukupno: 24000	Iskorišteno: 18577	Neiskorišteno: 22.6 %
5	LAT-80X8_A	Ukupno: 30000	Iskorišteno: 25255	Neiskorišteno: 15.8 %

3.6. Revizija radioničke dokumentacije

Kako je pripremu radioničke i narudžbene dokumentacije potrebno izvršiti nekoliko mjeseci prije same fizičke realizacije sekcije i bloka treba očekivati pojavu potrebe za revizijom dijela dokumentacije. Neki elementi konstrukcije će se mijenjati, dodavati će se novi elementi, dok će neki biti izbrisani s liste limova i profila. Dodavanjem dva nova koljena s pozicijom 800, Slika 13, neće trebati raditi novi raskroj (standardni dijelovi na skladištu), ali će nova revizija nacрта, nova wcog lista kao i nova lista limova biti potrebna.

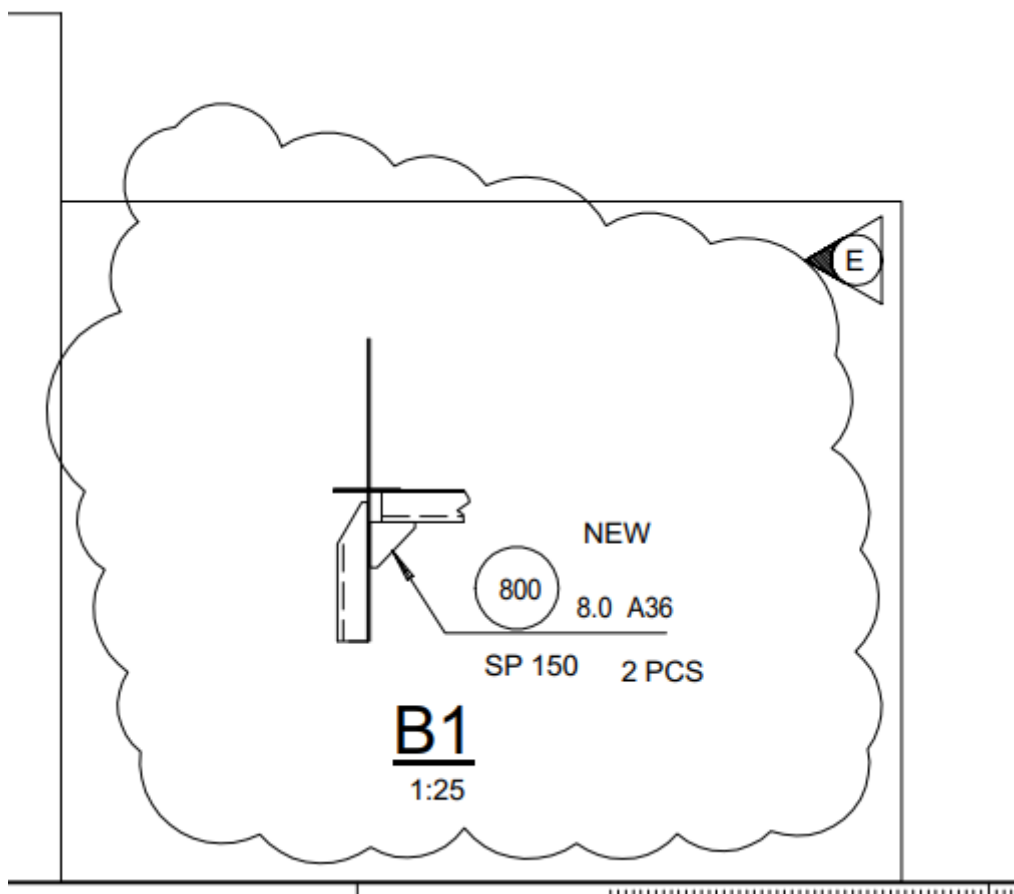

Slika 13. Revizija radioničke dokumentacije, [5]

4. PODJELA SEKCIJA NA SKLOPOVE

4.1. Definiranje naziva sklopa

Svaki građevni blok je podijeljen na više sekcija koje su sastavljene od sklopova. Blok 730 koji opisujemo ima temeljnu podjelu u odnosu na položaj koje sekcije imaju između dviju paluba koje su unutar pripadajućeg bloka. Svrha takve podjele je tehnološkičnost gradnje jer nakon što se spoje limovi palube i napravi roštilj palube, gotove sekcije pregrada ispod pregrade i sekcija oplata boka se spajaju u jednu cjelinu.

Kako opisujemo 14. palubu od rebra 124. do rebra 156, njen GPS4 (ime sekcije) će biti 7341. Broj 1 označava pripadnost sekciji palube, a broj 4 u nazivu se odnosi na četrnaestu palubu. Svi elementi koji pripadaju sekciji palube imati će GPS4 pod nazivom 7341. Sekcija pregrada ispod 14. palube kao i svi njeni elementi imati će GPS4 pod nazivom 7342. Zadnji broj 2 u nazivu sekcije označava pripadnost elemenata konstrukcije sekciji pregrada ispod četrnaeste palube. Sekcija oplata broda i njeni sklopovi imati će GPS4 naziv 7343 gdje broj 3 označava sekciju oplata.

Svaki sklop posjeduje i svoj vlastiti GPS2 (ime sklopa) koji je direktno vezan uz prostorni smještaj sklopa. Ako za primjer uzmemo panel 7343-L23AS-1S, iz njegovog imena može se iščitati kojem bloku i kojoj sekciji pripada. AS označava da se panel nalazi desno od centralne linije i ima pozicijski broj 1 na desnoj (starboard) strani. L23 nam govori da je to uzdužni element, smješten 13500 mm od centralne linije.

Panel 7343-L23AS-F140AS-1S, Slika 14, je podsklop od panela 7343-L23AS-1S i nalazi se na rebru FR140. Panel 7343-L23AS-F140AS-1S je zapravo T profil koji je zavaren na lim oplata broda 7343-L23AS-1S. Svi podsklopovi koji su vezani za neki sklop imati će njegov GPS1 u svom nazivu, u ovom slučaju GPS1=L23AS. Sve GPS oznake su prisutne u listi profila i listi limova, prilog V i VI.

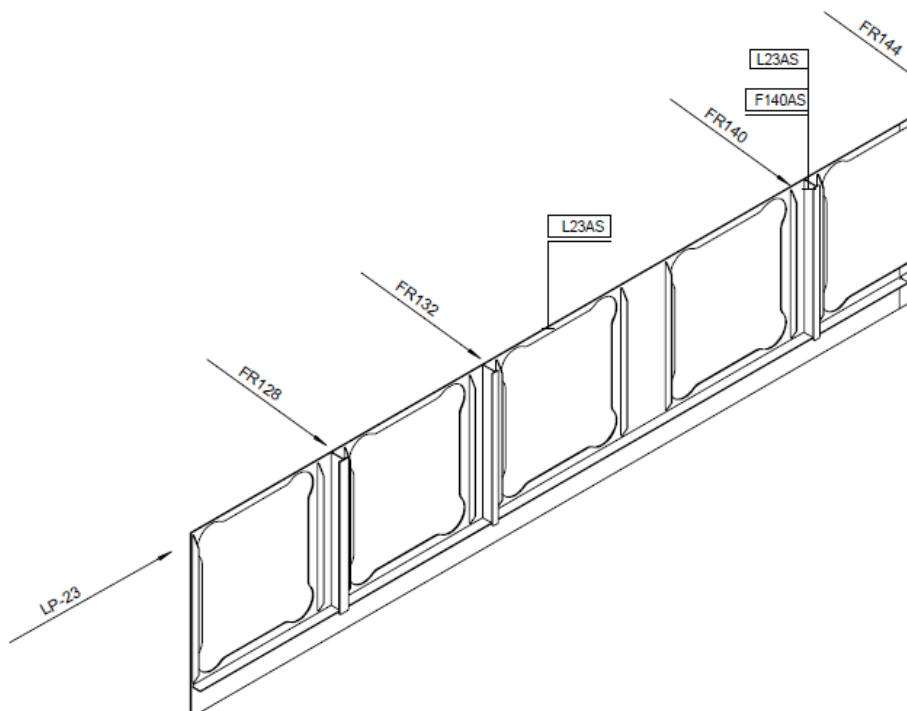

Slika 14. Sklop i podsklop, [5]

Ako blok ima podjelu sekcija na lijevu i desnu stranu onda se i njihova GPS4 imena moraju jasno razlikovati. Sekcije na lijevoj (portside) strani bi zadržale trenutne nazive sekcije 7341,7342 i 7343. Sekcije koje bi se nalazile na desnoj (starboard) strani imale bi nazive GPS4 7345 za sekciju palube, 7346 za sekciju pregrada ispod 14 palube i 7347 za sekciju oplata broda.

Kako pojedini elementi konstrukcije svojim položajem prelaze preko centralne linije, ime njihovog sklopa GPS2 imati će oznaku ASP u nazivu, Slika 15. Udaljavanjem od centralne linije, svaki sklop na pojedinom rebru dobio bi naziv GPS2 F154BP, F154CP, F154DP na lijevoj (portside) strani te nazive sklopova F154BS; F154CS, F154DS, na desnoj (starboard) strani.

Uzdužni element konstrukcije koji graniči sa susjednim blokom sa strane krme, Slika 14, se zove sklop 7343-L23AS-1S, dok bi prvi naredni imao naziv 7343-L23BS-1S i tako redom do granice bloka s pramčane strane.

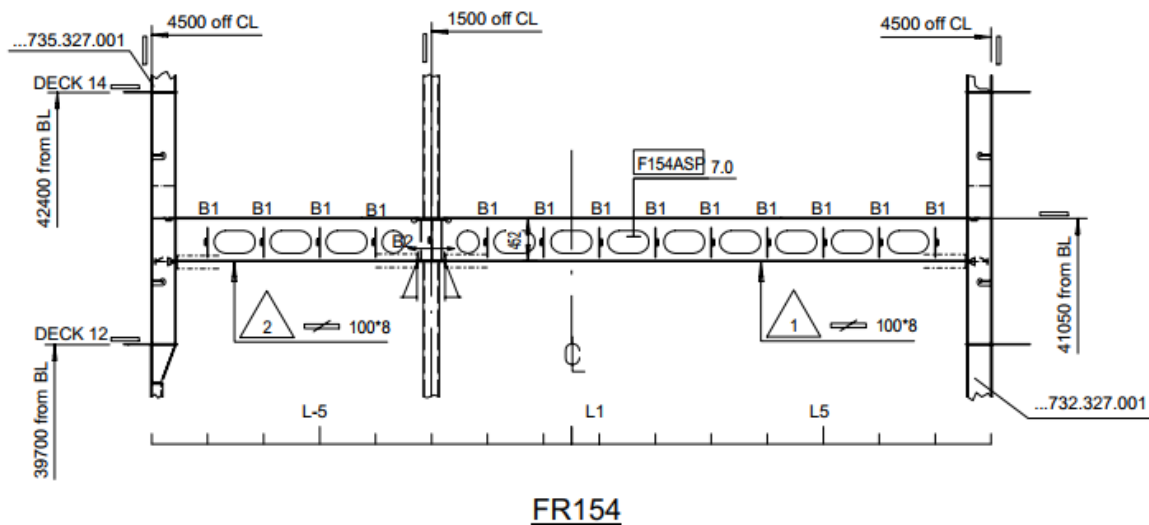

Slika 15. Određivanje naziva sklopa, [5]

4.2. Određivanje pozicijskih brojeva podsklopova

Brodogradilište pri gradnji broda nastoji ugraditi što je više standardnih dijelova. Svi elementi koji počinju od pozicijskog broja 800 ili 8000, Slika 16, su standardni dijelovi koji ne odlaze u raskroj materijala, već se nalaze na skladištu materijala.

Ti dijelovi nemaju GPS2 oznaku pripadnosti tom sklopu jer standardni element se može ugraditi u nekom drugom sklopu iste sekcije u skladu sa zahtjevima konstrukcije. Standardni dijelovi imaju identični funkcijski kod i pozicijski broj.

8820	'STD-DOOR REINFORCEMENT E300x30'	Standardi oviaukon vahvistus. E300x30	Standard local reinforcement for door and passage way E300x30	VKX	Pos-no = 8820	Not nested
8821	'STD-DOOR REINFORCEMENT E390x30'	Standardi oviaukon vahvistus. E390x30	Standard local reinforcement for door and passage way E390x30	VKX	Pos-no = 8821	Not nested
8822	'STD-DOOR REINFORCEMENT D409x40'	Standardi oviaukon vahvistus. D409x40	Standard local reinforcement for door and passage way EV409x40	VKX	Pos-no = 8822	Not nested
8823	'STD-DOOR REINFORCEMENT D409x50'	Standardi oviaukon vahvistus. D409x50	Standard local reinforcement for door and passage way D409x50	VKX	Pos-no = 8823	Not nested
8824	'STD-DOOR REINFORCEMENT D365x40'	Standardi oviaukon vahvistus. D365x40	Standard local reinforcement for door and passage way D365x40	VKX	Pos-no = 8824	Not nested
8825	'STD-DOOR REINFORCEMENT D365x50'	Standardi oviaukon vahvistus. D365x50	Standard local reinforcement for door and passage way D365x50	VKX	Pos-no = 8825	Not nested
8826	'STD-DOOR REINFORCEMENT D2370x25'	Standardi oviaukon vahvistus. D2370x25	Standard local reinforcement for door and passage way D2370x25	VKX	Pos-no = 8826	Not nested
8827	'STD-DOOR REINFORCEMENT D2370x30'	Standardi oviaukon vahvistus. D2370x30	Standard local reinforcement for door and passage way D2370x30	VKX	Pos-no = 8827	Not nested
8828	'STD-TRIPPING BRACKET'	Standardi nurjahduslatta. HP-100 ja T-460 risteyksessä. T-palkin laippa 8-10mm.	Standard tripping brackets. Intersection of HP-100 and T-460. T-bar flange 8-10mm.	VKX	Pos-no = 8828	Not nested
8829	'STD-CONSOLE BRACKET'	Standardi konsolin jatkolatta FB-70x10	Standard continuity flatbar FB-70x10	VKX	Pos-no = 8829	Not nested
8830	'STD-SHELL WEB BRACKET'	Standardi laitaubin pysty jatkolatta FB-40x10	Standard vertical continuity flatbar of shell web FB-40x10	VKX	Pos-no = 8830	Not nested
8831	'STD-BHD CORNER 5000'	Standardi laipioristeyksen nurkkapyöritystys. Korkeus 5000 mm	Standard bulkhead corner. High 5000 mm	VKX	Pos-no = 8831	Not nested
8832	'STD-BHD CORNER 4000'	Standardi laipioristeyksen nurkkapyöritystys. Korkeus 4000 mm	Standard bulkhead corner. High 4000 mm	VKX	Pos-no = 8832	Not nested
8833	'STD-BHD CORNER 3500'	Standardi laipioristeyksen nurkkapyöritystys. Korkeus 3500 mm	Standard bulkhead corner. High 3500 mm	VKX	Pos-no = 8833	Not nested
8834	'STD-BHD CORNER 3000'	Standardi laipioristeyksen nurkkapyöritystys. Korkeus 3000 mm	Standard bulkhead corner. High 3000 mm	VKX	Pos-no = 8834	Not nested
8835	'STD-BHD CORNER 2500'	Standardi laipioristeyksen nurkkapyöritystys. Korkeus 2500 mm	Standard bulkhead corner. High 2500 mm	VKX	Pos-no = 8835	Not nested
8901	'DOUBLING PLATE';	Tuplinki	Value = 'Doubling Plate'	VKX		00-series
8902	'INSERT PLATE';	Insertti	Value = 'Insert Plate'	VK45		00-series
8903	'PLATE PART';	Irrallinen levyosa	Independent plate part	VKX		00-series
8904	'DIAMOND PLATE';	Timattilevy	Value = 'Diamond plate'	VKX		00-series
8998	'LIFT SUPPORT PLATE';	nostotuenta	Value = 'Lift support plate'	VKX		00-series
8999	'LIFT SUPPORT PROFILE';	nostotuenta	Value = 'Lift support profile'	VKX		00-series

Slika 16. Popis standardnih dijelova, [9]

Kako bi se pregledom lista limova i profila odmah uočilo kakvu strukturnu funkciju i ostali manji elementi konstrukcije koji odlaze na raskroj materijala imaju, njihovi pozicijski brojevi imaju dogovorno određenu prvu znamenku u svom nazivu.

Svi elementi konstrukcije čiji pozicijski broj kreće od broja 100 su nestandardni dijelovi. Ti dijelovi idu na raskroj materijala i nemaju ni jedan element vezan uz sebe pa tako ni GPS2 u svom nazivu. Tipičan primjer za takav element je ojačanje na otvoru za vrata na nekoj pregradi.

Elementi konstrukcije čiji pozicijski broj kreće od broja 600 su nestandardna koljena. Elementi konstrukcije čiji pozicijski broj kreće od broja 500 su upore. One se uvijek modeliraju u sekciji palube ispod koje se nalaze, zajedno sa svojim pločom na koju su postavljene. Ploča i upora imaju identični pozicijski broj.

Elementi konstrukcije čiji pozicijski broj kreće od broja 300 su profili koji će se montirati tek nakon što su sve sekcije bloka dovršene i montirane te ugrađena sva oprema. To je preduvjet kako bi se ti dijelovi mogli nesmetano pozicionirati. Pozicijski broj nestandardnih zakrpa će kretati od broja 750. Svim nabrojanim nestandardnim dijelovima zajednička odlika je što u imenu svog naziva nemaju definiran GPS2. Svi elementi konstrukcije su prikazani u GN7342 wcog listi, prilog IV.

5. RADIONIČKA DOKUMENTACIJA ZA IZRADU SEKCIJE NADGRAĐA

5.1. Izrada radioničkih nacrtā

Radionička dokumentacija za izradu sekcije će se sastojati od nacrtā svake pojedinog sklopa i njegovim detaljima te tehnološkim uputama za montažu sklopa.

Na prvom nacrtu svake sekcije naznačeni su standardni razmaci uzdužnjaka i rebara te masa. Prikazan je položaj težišta sekcije uz oznaku kvalitete završne obrade materijala i standardna debljina zavara. Definiran je smjer gledanja promjene debljine materijala na šavovima između limova. Na skici profila broda je šrafirani smještaj bloka unutar kojeg se nalazi sekcija koju opisujemo.

Svaki sklop na nacrtu, Slika 17. ima označene svoje dimenzije i markaciju za gornju stranu panela. Samo elementi koji pripadaju ovom sklopu (zajednički GPS2) će se označiti na tom presjeku zbog bolje preglednosti nacrtā prilikom kontrole pozicijskih brojeva .

Svaki element pojedine sekcije mora biti prikazan na nacrtu sa svojim pozicijskim brojem i kvalitetom i debljinom materijala. Svi profili na nacrtu imaju svoj pozicijski broj unutar trokuta, dok limovi, koljena i pločice imaju pozicijski broj unutar kruga. Ako se profili moraju raskrojiti i oni će imati pozicijski broj označen krugom. Ako su otvori standardiziranih veličina kao što su vrata, Slika 17, oznaka za tipičan otvor se mora uvrstiti.

Uz svaki panel stoji oznaka za vrstu zavara kojom će se profili spojiti s limom. Na mjestu gdje sklop graniči s drugom sekcijom postaviti će se oznaka za skošenje rubova lima kao i sama oznaka za granicu sekcije ili bloka. Ako je sklop sastavljen od više limova svaki lim će imati markaciju šava i svoj pozicijski broj uz oznaku o promjeni debljine materijala.

Svi detalji označeni na pojedinom sklopu moraju biti prikazani baš na tom listu nacrtā. Ako postoji više jednakih detalja oni se prikazuju samo jednom uz oznaku o njihovoj količini. Nacrti sekcije pregrada ispod 14. palube dani su u prilogu VIII.

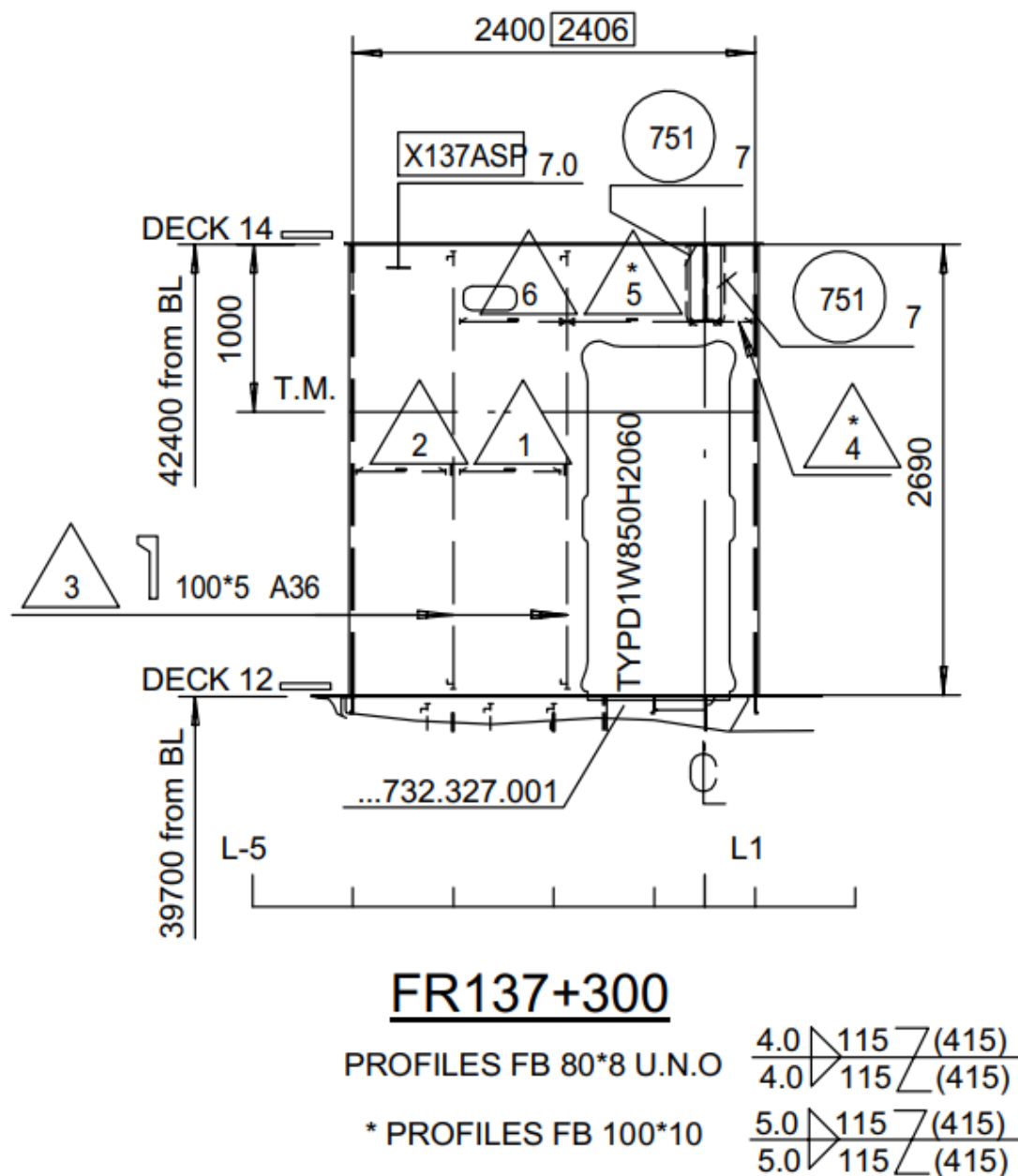

Slika 17. Radionički nacrt sklopa, [5]

Uz nacрте sklopova prilažu se i nacрти skica profila, Slika 18, kojima treba ručno skositi rubove ili treba izvršiti savijanje profila. Postavljanjem komentara u model profila, automatski se generira skica profila koja daje uputu monterima kako oblikovati i zavariti element konstrukcije, prilog VII.

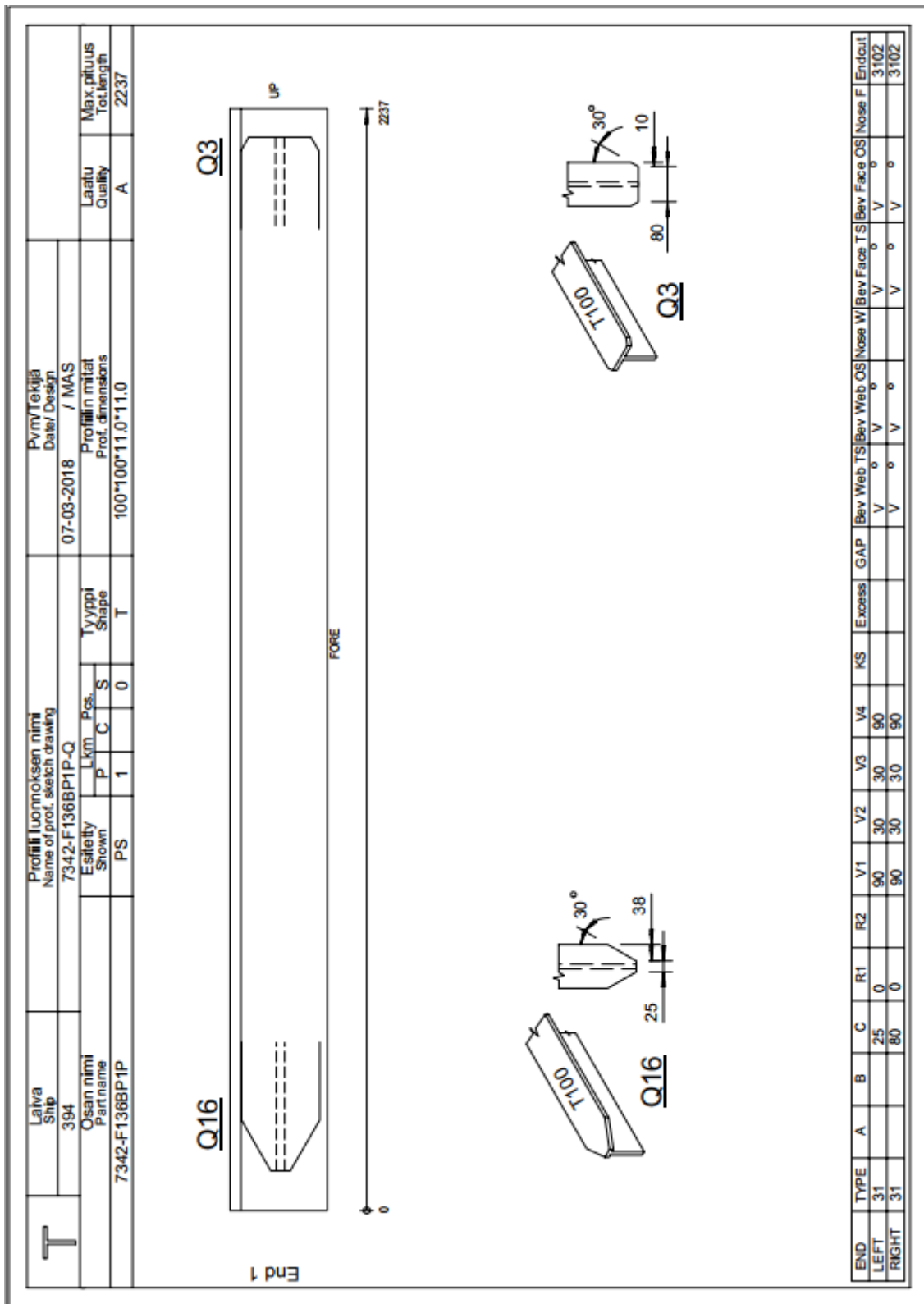

Slika 18. Priprema krajeva profila, [5]

6. TEHNOLOŠKA UPUTA ZA IZRADU I PREDMONTAŽU SKLOPOVA SEKCIJE I SEKCIJE NADGRAĐA

6.1. Smještaj bloka GB730

Blok GB730 se sastoji od 15. palube na visini 45100 mm od osnovice i strukture ispod 15. palube, 14 palube na visini 42400 mm od osnovice i strukture ispod 14 palube i 12 palube na visini 39700 mm od osnovice i strukture ispod 12 palube te se sastavlja u svojoj punoj širini bez podjele na lijevu i desnu stranu [4].

Blok GB730 se proteže između rebra FR124 + 200 mm do rebra FR158 + 200 mm. Blok GB730 će se postaviti iznad bloka GB430 i na stranu krme bloka GB740, Slika 1.

6.2. Izrada i predmontaža sekcije palube GN7341

Sekcija GN7341 okrupljenih limova palube u punoj veličini bloka GB730 će se sastaviti na liniji za izradu sklopova sastavljenih od ravnih panela.

Limovi će se sa skladišta materijala konvejerom dopremiti do linije za proizvodnju sklopova. Mosnom magnetnom dizalicom limovi će se dopremiti i posložiti na stol za zavarivanje.

Prvi korak zavarivanja, Slika 19, obaviti će se jednostranim zavarivanjem limova palube. Osiguravanje šava od prokapavanja taline vršit će se bakrenom šinjom koja brzo odvodi toplinu i omogućuje brzo ukrućivanje taline u korijenu zavara. Zavarivanje se vrši elektrolučno pod praškom uz pridržavanje hidrauličkim uređajem [6].

Svi izrezi na jumbo panelu palube će se napraviti prije postavljanja roštilja palube.



Slika 19. Zavarivanje limova palube, [10]

Izrada roštilja palube GN7341, Slika 20, kreće od profila 1. reda, uzdužnjaka koji su neprekinuti u punoj duljini. Potom se slažu interkostalne rebrenice u poprečnom smjeru. Profili roštilja, se postavljaju na markacije na limu hidrauličnim pritiskivačem i zavaruju kutnim zavarom obostrano EPP metodom.

Kako blok GB730 ima funkciju kabinskog prostora za putnike, kabine za putnike dolaze kao oprema i ugrađuju se nakon sklapanja cijelog bloka GB730. Upore, Slika 21, na 10500 mm lijevo i desno od centralne linije će se privariti uz pomoć privremenih koljena i L profila te nakon postavljanja putničkih kabina trajno zavariti, [9].

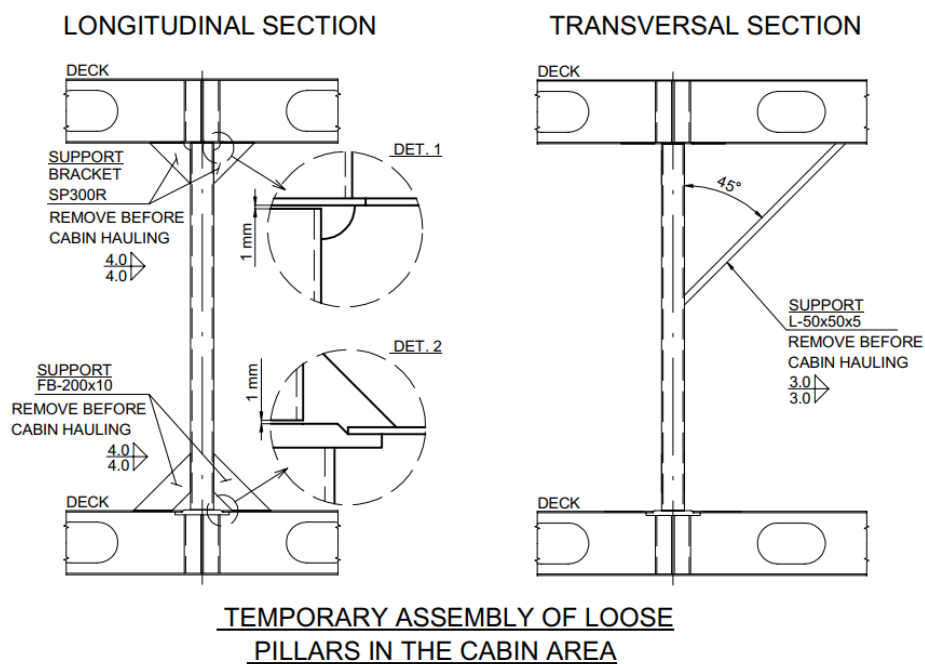

Slika 21. Privremeno ukrepljenje upora, [11]

6.3. Izrada i predmontaža sekcije palube GN7342 i sekcije oplata boka GN7343

Sekcija pregrada ispod palube 14. GN7342 i sekcije oplata boka GN7343 biti će sastavljeni na istoj proizvodnoj liniji. Gotovi sklopovi bloka GN7342 biti će dopremljeni i postavljeni na roštilj palube.

Na rebro FR136, Slika 22, izrezati će se privremeni otvori na lijevoj i desnoj strani od centralne linije, a oni će omogućiti montažu putničkih kabina na zadane pozicije. Sve trake i L profili koji će zatvoriti privremene otvore biti će točkasto zavareni i imati će pozicijski broj koji kreću od broja 300. (loose parts) jer se montiraju na rebro FR136 tek kad bude izvršena montaža cijele sekcije ispod 14. palube.

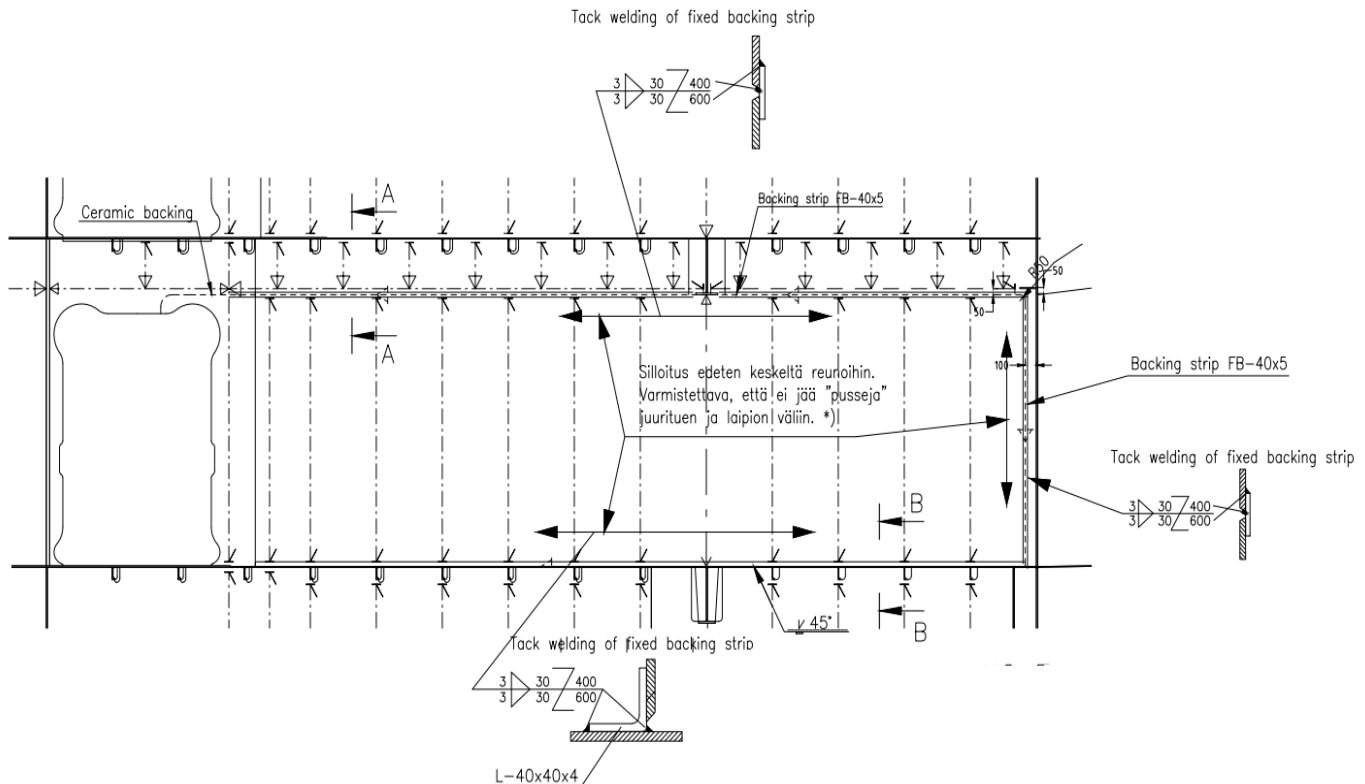

Slika 22. Privremeni otvori za transport, [12]

Nakon montiranja sekcije pregrada ispod palube montirati će se sekcija oplata boka broda. Za razliku od sekcije pregrada, sekcija oplata boka GN7343 se zavaruje obostranim kontinuiranim kutnim zavarom debljine 5 mm i dolazi s najboljom kvalitetom obrade površine lima jer se radi o vanjskoj vidljivoj pregradi. Konzole koje nose balkone su standardni sklop te se ne modeliraju, već postavljaju na završenu sekciju GN7343, Slika 23.



Slika 23. Sekcija oplata iz iste serije brodova

6.4. Kompletiranje grand bloka GB730

Nakon što su sve tri sekcije 14. palube kompletirane, okreću se s portalnom dizalicom i postavljaju na gornji dio sekcija 12. palube grand bloka GB730. Sekcije su spremne za daljnje opremanje i bojanje vanjske oplata bloka. Slika 24 prikazuje kompletiran grand blok GB730 s kontrolnim točkama za spajanje na susjedne blokove.

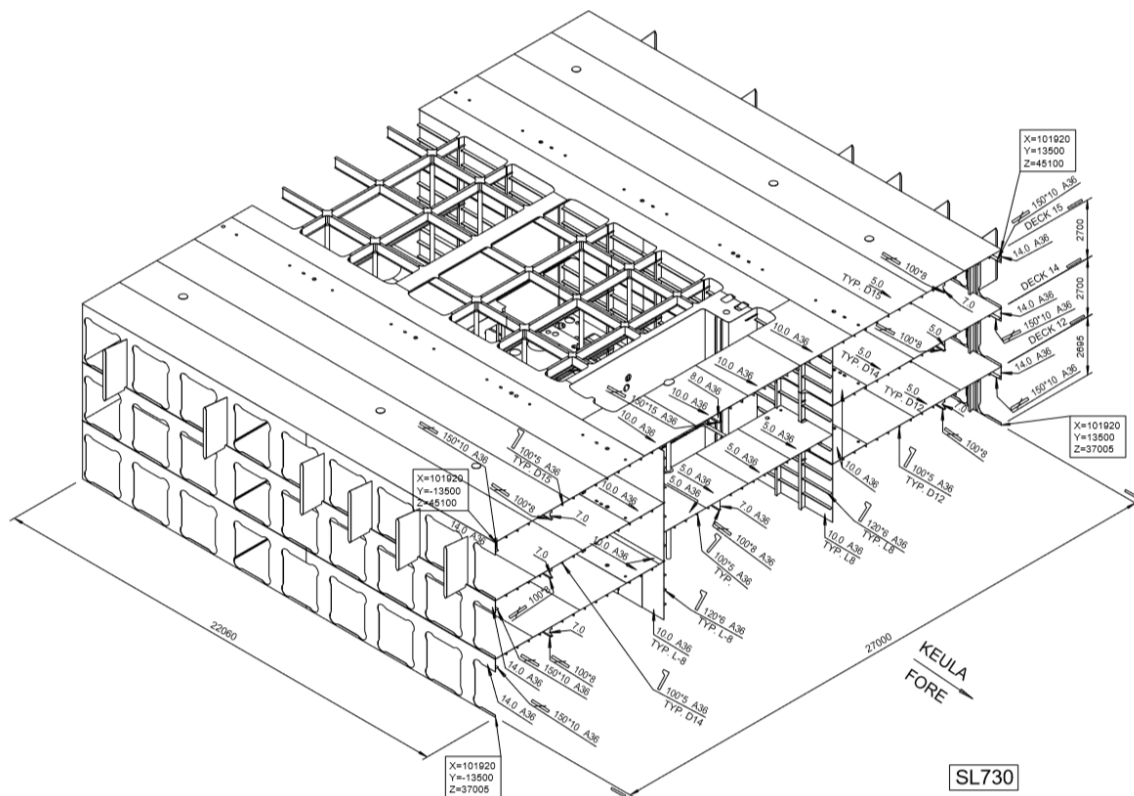

Slika 24. Grand blok GB730, [5]

Cijeli grand blok ima masu od preko 250 t pa će trebati tandem rad dviju portalnih dizalica kako bi se blok postavio na novogradnju u suhom doku, Slika 25.



Slika 25. Brod iz iste serije u suhom doku, [13]

7. ZAKLJUČAK

Razvojem računalne tehnologije i računalnih programa koji se mogu koristiti u brodograđevnom procesu skoro u potpunosti se promijenio način izrade radioničke dokumentacije i pripreme fizičke realizacije broda.

Proces razvoja i usavršavanja AVEVA Marine računalnog programa kontinuirano traje duže od 30 godina i prati sve nove zahtjeve brodograđevne proizvodnje. Najvažnije prednosti korištenja AVEVA Marine računalnog programa su ušteda na vremenu i standardizacija isporuke za pojedini blok koja se ostvari pripremom i izradom radioničke dokumentacije

Izrada modela broda je najzahtjevniji i najdugotrajniji dio posla koji konstruktor trupa treba obaviti kako bi se uopće izvršila priprema radioničke dokumentacije, ali dodana vrijednost gotovog modela se ogleda u mogućnosti njegovog korištenja za narednu novogradnju koja pripada istoj seriji brodova. Jednom kad je model pripremljen i usklađen s pravilima za gradnju može se pristupiti izradi radioničke dokumentacije.

Pokretanjem modula Plane Part Generation model broda se rastavi na pojedinačne elemente kako bi se izvršilo davanje imena i pozicijskih brojeva svakom elementu konstrukcije što je uvjet da se elementi konstrukcije pošalju na raskroj materijala.

Isporuka dokumentacije za svaku sekciju se sastoji od narudžbene i radioničke dokumentacije. Narudžbena dokumentacija sadrži popis limova i profila koje je potrebno naručiti iz valjaonice limova kako bi se pristupilo raskroju materijala i pripremi fizičke realizacije sekcije broda.

Radionička dokumentacija svake sekcije se sastoji od popisa raskrojanih limova i profila koji sadrže sve ključne informacije za svaki element konstrukcije. Uz priložene liste dolaze i radionički nacrti sekcije koji su uputa monterima u radionicama kako sastaviti sklopove i spojiti ih u sekciju.

Isporuka tehničke dokumentacije se obavlja nekoliko mjeseci prije početka gradnje sekcije broda i biti će provjerena od strane odjela proizvodnje trupa.

Kako je proces gradnje broda kompleksan proces i sklon promjenama i revizijama, tehnička dokumentacija za svaku sekciju će se mijenjati i nadopunjavati i u fazi izrade same sekcije. Posljednja revizija tehničke dokumentacije i stanje modela poslužiti će kao početna točka pri gradnji broda iz iste serije.

LITERATURA

- [1] Hadžić,N.: Tehnologija brodogradnje I, FSB, Zagreb, 2018
- [2] <https://www.aveva.com>
- [3] AVEVA Marine (11 series) training guide, Turku, 2010.
- [4] Meyer Turku: Welding shrinkage compensation, Turku, 2017.
- [5] AVEVA Marine software
- [6] Sladoljev, Ž.: Tehnologija brodogradnje, skripta,FSB, Zagreb, 1997
- [7] <https://www.paluba.info>
- [8] <http://www.voestalpine.com/durostat/en/Solutions/Product-range>
- [9] <https://kronodoc.meyerturku.fi/kronodoc/gb> building methods
- [10] <https://www.meyerwerft.de>
- [11] Meyer Turku:Typical structural details, Turku, 2016.
- [12] Meyer Turku: Typical Openings for Transport, Turku, 2017.
- [13] <https://www.vesselfinder.com/>

PRILOZI

- I. GEN_KGN7342_001
- II. Raskroj materijala GN7342
- III. GAT nacrti_GN7341
- IV. GN7342Wcog -lista
- V. Lista limova_GN7342
- VI. Lista profila _GN7342
- VII. Profile sketch_ GN7342
- VIII. Radionički nacrti_GN7342

I. GEN_KGN7342_001

GENERAL_DATA
TYPE_OF_GENERIC_FILE=PLATE_PART
TYPE_OF_MANUFACT=2AXIS
BURNER_ID=K
NEST_NAME=KGN7342_001
RAW_NAME=
RAW_LENGTH=515.00
RAW_WIDTH=140.00
RAW_THICKNESS=7.00
RAW_AREA=0.07
QUALITY=A
DENSITY=8100.00
SURF_TREAT_TS=
SURF_TREAT_OS=
REST_LENGTH=0.00
SPLIT_DATE=
PRODUCTION_DATE=
NO_OF_PARTS=10
TOTAL_IDLE=0.50
TOTAL_MARKING=0.00
TOTAL_BURNING=1145.60
TOTAL_BLASTING=0.00
TOTAL_MARK_BLAST=0.00
TOTAL_NO_OF_STARTS=1
NO_OF_BURNING_STARTS=1
NO_OF_MARKING_STARTS=0
NO_OF_BLASTING_STARTS=0
NO_OF_MARK_BLAST_STARTS=0
STARTING_POS_X=0.00
STARTING_POS_Y=0.00
QUANTITY_NORMAL=1
QUANTITY_MIRRORED=0
TOOL_ID=4
PROCESS_ID=
SEQUENCE=
MATERIAL_CODE=
PURCHASE_INFO=
VERIFICATION_DATE=2018-03-06
PLATE_ALIGNMENT=
END_OF_GENERAL_DATA
PART_DATA
NAME=GN7342-F136ASP/C4SP
POSNO=751
PARTNAME_LONG=7342-751P
PARTNAME_LONG_SB=
SHIP_NO=394
ASSEMBLY_LOW=
ASSEMBLY_LOW_SB=
ASSEMBLY_HIGH=
ASSEMBLY_HIGH_SB=

BLOCK_NO=GN7342
PART_AREA=49434.93
MIRRORED=0
CLIP_GRINDING_SIDE=UP
CUST_DATA_1=
CUST_DATA_2=F136ASP
CUST_DATA_3=
CUST_DATA_4=7342
CUST_TEXT_1=
CUST_TEXT_2=
CUST_TEXT_3=
CUST_TEXT_4=
CUST_TEXT_5=
CUST_TEXT_6=
CUST_TEXT_7=
CUST_TEXT_8=
CUST_TEXT_9=
CUST_TEXT_10=
WORKING_LOCATION=
BUILDING_STRATEGY=
PLANNING_UNIT=
EXTENSION_U=480.00000
EXTENSION_V=108.00006
PLATE_SIDE=PS
PANEL_NAME=
PART_COG_U=239.57794
PART_COG_V=53.55674
NESTED_ON=
KNUCKLED=
RAW_NAME=
NO_INTERVALS_EXCESS_1=0
LENGTH_EXCESS_1=0.00000
NO_INTERVALS_EXCESS_2=0
LENGTH_EXCESS_2=0.00000
NO_INTERVALS_EXCESS_3=0
LENGTH_EXCESS_3=0.00000
DESTINATION=
COMMENT=
FUNCTIONAL_DESCR_CODE=3111
FUNCTIONAL_DESCR_TEXT=F-BHD (U12M NS)
END_OF_PART_DATA
PART_DATA
NAME=GN7342-F136ASP/C1SP
POSNO=751
PARTNAME_LONG=7342-751S
PARTNAME_LONG_SB=
SHIP_NO=394
ASSEMBLY_LOW=
ASSEMBLY_LOW_SB=
ASSEMBLY_HIGH=

ASSEMBLY_HIGH_SB=
BLOCK_NO=GN7342
PART_AREA=49434.93
MIRRORED=0
CLIP_GRINDING_SIDE=DOWN
CUST_DATA_1=
CUST_DATA_2=F136ASP
CUST_DATA_3=
CUST_DATA_4=7342
CUST_TEXT_1=
CUST_TEXT_2=
CUST_TEXT_3=
CUST_TEXT_4=
CUST_TEXT_5=
CUST_TEXT_6=
CUST_TEXT_7=
CUST_TEXT_8=
CUST_TEXT_9=
CUST_TEXT_10=
WORKING_LOCATION=
BUILDING_STRATEGY=
PLANNING_UNIT=
EXTENSION_U=108.00000
EXTENSION_V=480.00000
PLATE_SIDE=SB
PANEL_NAME=
PART_COG_U=620.23060
PART_COG_V=245.87545
NESTED_ON=
KNUCKLED=
RAW_NAME=
NO_INTERVALS_EXCESS_1=0
LENGTH_EXCESS_1=0.00000
NO_INTERVALS_EXCESS_2=0
LENGTH_EXCESS_2=0.00000
NO_INTERVALS_EXCESS_3=0
LENGTH_EXCESS_3=0.00000
DESTINATION=
COMMENT=
FUNCTIONAL_DESCR_CODE=3111
FUNCTIONAL_DESCR_TEXT=F-BHD (U12M NS)
END_OF_PART_DATA
PART_DATA
NAME=GN7342-F136ASP/C2SP
POSNO=751
PARTNAME_LONG=7342-751S
PARTNAME_LONG_SB=
SHIP_NO=394
ASSEMBLY_LOW=
ASSEMBLY_LOW_SB=

ASSEMBLY_HIGH=
ASSEMBLY_HIGH_SB=
BLOCK_NO=GN7342
PART_AREA=49434.93
MIRRORED=0
CLIP_GRINDING_SIDE=DOWN
CUST_DATA_1=
CUST_DATA_2=F136ASP
CUST_DATA_3=
CUST_DATA_4=7342
CUST_TEXT_1=
CUST_TEXT_2=
CUST_TEXT_3=
CUST_TEXT_4=
CUST_TEXT_5=
CUST_TEXT_6=
CUST_TEXT_7=
CUST_TEXT_8=
CUST_TEXT_9=
CUST_TEXT_10=
WORKING_LOCATION=
BUILDING_STRATEGY=
PLANNING_UNIT=
EXTENSION_U=108.00000
EXTENSION_V=480.00000
PLATE_SIDE=SB
PANEL_NAME=
PART_COG_U=638.69695
PART_COG_V=263.45519
NESTED_ON=
KNUCKLED=
RAW_NAME=
NO_INTERVALS_EXCESS_1=0
LENGTH_EXCESS_1=0.00000
NO_INTERVALS_EXCESS_2=0
LENGTH_EXCESS_2=0.00000
NO_INTERVALS_EXCESS_3=0
LENGTH_EXCESS_3=0.00000
DESTINATION=
COMMENT=
FUNCTIONAL_DESCR_CODE=3111
FUNCTIONAL_DESCR_TEXT=F-BHD (U12M NS)
END_OF_PART_DATA
PART_DATA
NAME=GN7342-F136ASP/C3SP
POSNO=751
PARTNAME_LONG=7342-751S
PARTNAME_LONG_SB=
SHIP_NO=394
ASSEMBLY_LOW=

ASSEMBLY_LOW_SB=
ASSEMBLY_HIGH=
ASSEMBLY_HIGH_SB=
BLOCK_NO=GN7342
PART_AREA=49434.93
MIRRORED=0
CLIP_GRINDING_SIDE=UP
CUST_DATA_1=
CUST_DATA_2=F136ASP
CUST_DATA_3=
CUST_DATA_4=7342
CUST_TEXT_1=
CUST_TEXT_2=
CUST_TEXT_3=
CUST_TEXT_4=
CUST_TEXT_5=
CUST_TEXT_6=
CUST_TEXT_7=
CUST_TEXT_8=
CUST_TEXT_9=
CUST_TEXT_10=
WORKING_LOCATION=
BUILDING_STRATEGY=
PLANNING_UNIT=
EXTENSION_U=108.00000
EXTENSION_V=480.00000
PLATE_SIDE=SB
PANEL_NAME=
PART_COG_U=652.61433
PART_COG_V=293.98843
NESTED_ON=
KNUCKLED=
RAW_NAME=
NO_INTERVALS_EXCESS_1=0
LENGTH_EXCESS_1=0.00000
NO_INTERVALS_EXCESS_2=0
LENGTH_EXCESS_2=0.00000
NO_INTERVALS_EXCESS_3=0
LENGTH_EXCESS_3=0.00000
DESTINATION=
COMMENT=
FUNCTIONAL_DESCR_CODE=3111
FUNCTIONAL_DESCR_TEXT=F-BHD (U12M NS)
END_OF_PART_DATA
PART_DATA
NAME=GN7342-X135ASP/C1SP
POSNO=751
PARTNAME_LONG=7342-751S
PARTNAME_LONG_SB=
SHIP_NO=394

ASSEMBLY_LOW=
ASSEMBLY_LOW_SB=
ASSEMBLY_HIGH=
ASSEMBLY_HIGH_SB=
BLOCK_NO=GN7342
PART_AREA=49434.93
MIRRORED=0
CLIP_GRINDING_SIDE=UP
CUST_DATA_1=
CUST_DATA_2=X135ASP
CUST_DATA_3=
CUST_DATA_4=7342
CUST_TEXT_1=
CUST_TEXT_2=
CUST_TEXT_3=
CUST_TEXT_4=
CUST_TEXT_5=
CUST_TEXT_6=
CUST_TEXT_7=
CUST_TEXT_8=
CUST_TEXT_9=
CUST_TEXT_10=
WORKING_LOCATION=
BUILDING_STRATEGY=
PLANNING_UNIT=
EXTENSION_U=108.00000
EXTENSION_V=480.00000
PLATE_SIDE=SB
PANEL_NAME=
PART_COG_U=674.82033
PART_COG_V=309.71767
NESTED_ON=
KNUCKLED=
RAW_NAME=
NO_INTERVALS_EXCESS_1=0
LENGTH_EXCESS_1=0.00000
NO_INTERVALS_EXCESS_2=0
LENGTH_EXCESS_2=0.00000
NO_INTERVALS_EXCESS_3=0
LENGTH_EXCESS_3=0.00000
DESTINATION=
COMMENT=
FUNCTIONAL_DESCR_CODE=3111
FUNCTIONAL_DESCR_TEXT=F-BHD (U12M NS)
END_OF_PART_DATA
PART_DATA
NAME=GN7342-X137ASP/C1SP
POSNO=751
PARTNAME_LONG=7342-751S
PARTNAME_LONG_SB=

SHIP_NO=394
ASSEMBLY_LOW=
ASSEMBLY_LOW_SB=
ASSEMBLY_HIGH=
ASSEMBLY_HIGH_SB=
BLOCK_NO=GN7342
PART_AREA=49434.93
MIRRORED=0
CLIP_GRINDING_SIDE=UP
CUST_DATA_1=
CUST_DATA_2=X137ASP
CUST_DATA_3=
CUST_DATA_4=7342
CUST_TEXT_1=
CUST_TEXT_2=
CUST_TEXT_3=
CUST_TEXT_4=
CUST_TEXT_5=
CUST_TEXT_6=
CUST_TEXT_7=
CUST_TEXT_8=
CUST_TEXT_9=
CUST_TEXT_10=
WORKING_LOCATION=
BUILDING_STRATEGY=
PLANNING_UNIT=
EXTENSION_U=108.00000
EXTENSION_V=480.00000
PLATE_SIDE=SB
PANEL_NAME=
PART_COG_U=695.17580
PART_COG_V=330.07314
NESTED_ON=
KNUCKLED=
RAW_NAME=
NO_INTERVALS_EXCESS_1=0
LENGTH_EXCESS_1=0.00000
NO_INTERVALS_EXCESS_2=0
LENGTH_EXCESS_2=0.00000
NO_INTERVALS_EXCESS_3=0
LENGTH_EXCESS_3=0.00000
DESTINATION=
COMMENT=
FUNCTIONAL_DESCR_CODE=3111
FUNCTIONAL_DESCR_TEXT=F-BHD (U12M NS)
END_OF_PART_DATA
PART_DATA
NAME=GN7342-F136ASP/C5SP
POSNO=751
PARTNAME_LONG=7342-751P

PARTNAME_LONG_SB=
SHIP_NO=394
ASSEMBLY_LOW=
ASSEMBLY_LOW_SB=
ASSEMBLY_HIGH=
ASSEMBLY_HIGH_SB=
BLOCK_NO=GN7342
PART_AREA=49434.93
MIRRORED=0
CLIP_GRINDING_SIDE=UP
CUST_DATA_1=
CUST_DATA_2=F136ASP
CUST_DATA_3=
CUST_DATA_4=7342
CUST_TEXT_1=
CUST_TEXT_2=
CUST_TEXT_3=
CUST_TEXT_4=
CUST_TEXT_5=
CUST_TEXT_6=
CUST_TEXT_7=
CUST_TEXT_8=
CUST_TEXT_9=
CUST_TEXT_10=
WORKING_LOCATION=
BUILDING_STRATEGY=
PLANNING_UNIT=
EXTENSION_U=108.00000
EXTENSION_V=480.00000
PLATE_SIDE=PS
PANEL_NAME=
PART_COG_U=905.20747
PART_COG_V=280.10967
NESTED_ON=
KNUCKLED=
RAW_NAME=
NO_INTERVALS_EXCESS_1=0
LENGTH_EXCESS_1=0.00000
NO_INTERVALS_EXCESS_2=0
LENGTH_EXCESS_2=0.00000
NO_INTERVALS_EXCESS_3=0
LENGTH_EXCESS_3=0.00000
DESTINATION=
COMMENT=
FUNCTIONAL_DESCR_CODE=3111
FUNCTIONAL_DESCR_TEXT=F-BHD (U12M NS)
END_OF_PART_DATA
PART_DATA
NAME=GN7342-F136ASP/C6SP
POSNO=751

PARTNAME_LONG=7342-751P
PARTNAME_LONG_SB=
SHIP_NO=394
ASSEMBLY_LOW=
ASSEMBLY_LOW_SB=
ASSEMBLY_HIGH=
ASSEMBLY_HIGH_SB=
BLOCK_NO=GN7342
PART_AREA=49434.93
MIRRORED=0
CLIP_GRINDING_SIDE=UP
CUST_DATA_1=
CUST_DATA_2=F136ASP
CUST_DATA_3=
CUST_DATA_4=7342
CUST_TEXT_1=
CUST_TEXT_2=
CUST_TEXT_3=
CUST_TEXT_4=
CUST_TEXT_5=
CUST_TEXT_6=
CUST_TEXT_7=
CUST_TEXT_8=
CUST_TEXT_9=
CUST_TEXT_10=
WORKING_LOCATION=
BUILDING_STRATEGY=
PLANNING_UNIT=
EXTENSION_U=108.00000
EXTENSION_V=480.00000
PLATE_SIDE=PS
PANEL_NAME=
PART_COG_U=916.27178
PART_COG_V=292.13793
NESTED_ON=
KNUCKLED=
RAW_NAME=
NO_INTERVALS_EXCESS_1=0
LENGTH_EXCESS_1=0.00000
NO_INTERVALS_EXCESS_2=0
LENGTH_EXCESS_2=0.00000
NO_INTERVALS_EXCESS_3=0
LENGTH_EXCESS_3=0.00000
DESTINATION=
COMMENT=
FUNCTIONAL_DESCR_CODE=3111
FUNCTIONAL_DESCR_TEXT=F-BHD (U12M NS)
END_OF_PART_DATA
PART_DATA
NAME=GN7342-X135ASP/C2SP

POSNO=751
PARTNAME_LONG=7342-751P
PARTNAME_LONG_SB=
SHIP_NO=394
ASSEMBLY_LOW=
ASSEMBLY_LOW_SB=
ASSEMBLY_HIGH=
ASSEMBLY_HIGH_SB=
BLOCK_NO=GN7342
PART_AREA=49434.93
MIRRORED=0
CLIP_GRINDING_SIDE=UP
CUST_DATA_1=
CUST_DATA_2=X135ASP
CUST_DATA_3=
CUST_DATA_4=7342
CUST_TEXT_1=
CUST_TEXT_2=
CUST_TEXT_3=
CUST_TEXT_4=
CUST_TEXT_5=
CUST_TEXT_6=
CUST_TEXT_7=
CUST_TEXT_8=
CUST_TEXT_9=
CUST_TEXT_10=
WORKING_LOCATION=
BUILDING_STRATEGY=
PLANNING_UNIT=
EXTENSION_U=108.00000
EXTENSION_V=480.00000
PLATE_SIDE=PS
PANEL_NAME=
PART_COG_U=928.30003
PART_COG_V=306.94192
NESTED_ON=
KNUCKLED=
RAW_NAME=
NO_INTERVALS_EXCESS_1=0
LENGTH_EXCESS_1=0.00000
NO_INTERVALS_EXCESS_2=0
LENGTH_EXCESS_2=0.00000
NO_INTERVALS_EXCESS_3=0
LENGTH_EXCESS_3=0.00000
DESTINATION=
COMMENT=
FUNCTIONAL_DESCR_CODE=3111
FUNCTIONAL_DESCR_TEXT=F-BHD (U12M NS)
END_OF_PART_DATA
PART_DATA

NAME=GN7342-X137ASP/C2SP
POSNO=751
PARTNAME_LONG=7342-751P
PARTNAME_LONG_SB=
SHIP_NO=394
ASSEMBLY_LOW=
ASSEMBLY_LOW_SB=
ASSEMBLY_HIGH=
ASSEMBLY_HIGH_SB=
BLOCK_NO=GN7342
PART_AREA=49434.93
MIRRORED=0
CLIP_GRINDING_SIDE=UP
CUST_DATA_1=
CUST_DATA_2=X137ASP
CUST_DATA_3=
CUST_DATA_4=7342
CUST_TEXT_1=
CUST_TEXT_2=
CUST_TEXT_3=
CUST_TEXT_4=
CUST_TEXT_5=
CUST_TEXT_6=
CUST_TEXT_7=
CUST_TEXT_8=
CUST_TEXT_9=
CUST_TEXT_10=
WORKING_LOCATION=
BUILDING_STRATEGY=
PLANNING_UNIT=
EXTENSION_U=108.00000
EXTENSION_V=480.00000
PLATE_SIDE=PS
PANEL_NAME=
PART_COG_U=945.87981
PART_COG_V=319.89541
NESTED_ON=
KNUCKLED=
RAW_NAME=
NO_INTERVALS_EXCESS_1=0
LENGTH_EXCESS_1=0.00000
NO_INTERVALS_EXCESS_2=0
LENGTH_EXCESS_2=0.00000
NO_INTERVALS_EXCESS_3=0
LENGTH_EXCESS_3=0.00000
DESTINATION=
COMMENT=
FUNCTIONAL_DESCR_CODE=3111
FUNCTIONAL_DESCR_TEXT=F-BHD (U12M NS)
END_OF_PART_DATA

PART_INFORMATION
PART_NAME=GN7342-F136ASP/C4SP
TYPE_OF_WORK=BURNING
END_OF_PART_INFORMATION
IDLE_DATA
START_OF_CONTOUR
NO_OF_SEG=1
START_U=0.00000
START_V=0.00000
AMP_U=0.00000
AMP_V=0.00000
AMP=0.00000
RADIUS=0.00000
SWEEP=0.00000
ORIGIN_U=0.00000
ORIGIN_V=0.00000
U=0.50002
V=-0.00000
END_OF_CONTOUR
END_OF_IDLE_DATA
BURNING_DATA
SHAPE=START_HOOK
START_END_IN_GAP=1
BEVEL_DEFINED=0
DIRECTION=-1
NUMBER_OF_HEADS=1
GEOMETRY_VALID_FOR=1
DISTANCE_Y1_Y2=0.00
START_OF_CONTOUR
BEVEL_DATA
BEVEL=NONE
BEVEL_CODE=0.00
BEVEL_NAME=
BEVEL_TYPE=0
BEVEL_VARIANT=0
PLATE_THICKNESS=7.00
E=0.00
ANGLE_TS=0.00
ANGLE2_TS=0.00
ANGLE_OS=0.00
ANGLE2_OS=0.00
DEPTH_TS=0.00
DEPTH_OS=0.00
CHAMFER_WIDTH_TS=0.00
CHAMFER_WIDTH_OS=0.00
ANGLE2_WTS=0.00
ANGLE2_WOS=0.00
CHAMFER_HEIGHT_TS=0.00
CHAMFER_HEIGHT_OS=0.00
END_OF_BEVEL_DATA

NO_OF_SEG=1
START_U=0.50002
START_V=-0.00000
AMP_U=0.00000
AMP_V=0.00000
AMP=0.00000
RADIUS=0.00000
SWEEP=0.00000
ORIGIN_U=0.00000
ORIGIN_V=0.00000
U=10.50001
V=-0.00000
END_OF_CONTOUR
END_OF_BURNING_DATA
BURNING_DATA
SHAPE=OUTER_CONTOUR
START_END_IN_GAP=
BEVEL_DEFINED=
DIRECTION=-1
NUMBER_OF_HEADS=1
GEOMETRY_VALID_FOR=1
DISTANCE_Y1_Y2=0.00
START_OF_CONTOUR
BEVEL_DATA
BEVEL=NONE
BEVEL_CODE=0.00
BEVEL_NAME=
BEVEL_TYPE=0
BEVEL_VARIANT=0
PLATE_THICKNESS=7.00
E=0.00
ANGLE_TS=0.00
ANGLE2_TS=0.00
ANGLE_OS=0.00
ANGLE2_OS=0.00
DEPTH_TS=0.00
DEPTH_OS=7.00
CHAMFER_WIDTH_TS=0.00
CHAMFER_WIDTH_OS=0.00
ANGLE2_WTS=0.00
ANGLE2_WOS=0.00
CHAMFER_HEIGHT_TS=0.00
CHAMFER_HEIGHT_OS=0.00
END_OF_BEVEL_DATA
NO_OF_SEG=10
START_U=10.50001
START_V=-0.00000
AMP_U=0.00000
AMP_V=0.00000
AMP=0.00000

RADIUS=0.00000
SWEEP=0.00000
ORIGIN_U=0.00000
ORIGIN_V=0.00000
U=430.00001
V=0.00005
AMP_U=12.42641
AMP_V=-12.42641
AMP=17.57359
RADIUS=60.00000
SWEEP=1.57080
ORIGIN_U=430.00001
ORIGIN_V=60.00005
U=490.00001
V=60.00006
AMP_U=0.00000
AMP_V=0.00000
AMP=0.00000
RADIUS=0.00000
SWEEP=0.00000
ORIGIN_U=0.00000
ORIGIN_V=0.00000
U=487.00001
V=63.00006
AMP_U=0.00000
AMP_V=0.00000
AMP=0.00000
RADIUS=0.00000
SWEEP=0.00000
ORIGIN_U=0.00000
ORIGIN_V=0.00000
U=458.00001
V=63.00006
AMP_U=0.00000
AMP_V=0.00000
AMP=0.00000
RADIUS=0.00000
SWEEP=0.00000
ORIGIN_U=0.00000
ORIGIN_V=0.00000
U=456.00001
V=65.00006
AMP_U=0.00000
AMP_V=0.00000
AMP=0.00000
RADIUS=0.00000
SWEEP=0.00000
ORIGIN_U=0.00000
ORIGIN_V=0.00000
U=456.00000

V=98.00006
AMP_U=0.00000
AMP_V=0.00000
AMP=0.00000
RADIUS=0.00000
SWEEP=0.00000
ORIGIN_U=0.00000
ORIGIN_V=0.00000
U=446.00000
V=108.00006
AMP_U=0.00000
AMP_V=0.00000
AMP=0.00000
RADIUS=0.00000
SWEEP=0.00000
ORIGIN_U=0.00000
ORIGIN_V=0.00000
U=20.00000
V=108.00000
AMP_U=0.00000
AMP_V=0.00000
AMP=0.00000
RADIUS=0.00000
SWEEP=0.00000
ORIGIN_U=0.00000
ORIGIN_V=0.00000
U=10.00000
V=98.00000
AMP_U=0.00000
AMP_V=0.00000
AMP=0.00000
RADIUS=0.00000
SWEEP=0.00000
ORIGIN_U=0.00000
ORIGIN_V=0.00000
U=10.00001
V=0.50000
END_OF_CONTOUR
END_OF_BURNING_DATA
BURNING_DATA
SHAPE=END_HOOK
START_END_IN_GAP=1
BEVEL_DEFINED=
DIRECTION=-1
NUMBER_OF_HEADS=1
GEOMETRY_VALID_FOR=1
DISTANCE_Y1_Y2=0.00
START_OF_CONTOUR
BEVEL_DATA
BEVEL=NONE

BEVEL_CODE=0.00
BEVEL_NAME=
BEVEL_TYPE=0
BEVEL_VARIANT=0
PLATE_THICKNESS=7.00
E=0.00
ANGLE_TS=0.00
ANGLE2_TS=0.00
ANGLE_OS=0.00
ANGLE2_OS=0.00
DEPTH_TS=0.00
DEPTH_OS=7.00
CHAMFER_WIDTH_TS=0.00
CHAMFER_WIDTH_OS=0.00
ANGLE2_WTS=0.00
ANGLE2_WOS=0.00
CHAMFER_HEIGHT_TS=0.00
CHAMFER_HEIGHT_OS=0.00
END_OF_BEVEL_DATA
NO_OF_SEG=1
START_U=10.00001
START_V=0.50000
AMP_U=0.00000
AMP_V=0.00000
AMP=0.00000
RADIUS=0.00000
SWEEP=0.00000
ORIGIN_U=0.00000
ORIGIN_V=0.00000
U=10.00001
V=-0.50000
END_OF_CONTOUR
END_OF_BURNING_DATA
PART_INFORMATION
PART_NAME=GN7342-F136ASP/C4SP
TYPE_OF_WORK=
END_OF_PART_INFORMATION

II. Raskroj materijala GN7342

Detail
Details

Ellei toisin n[]ytetty
If not stated otherwise

Hitsit/ Weldings

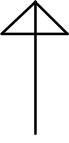

Puhd.aste
Prep. this side

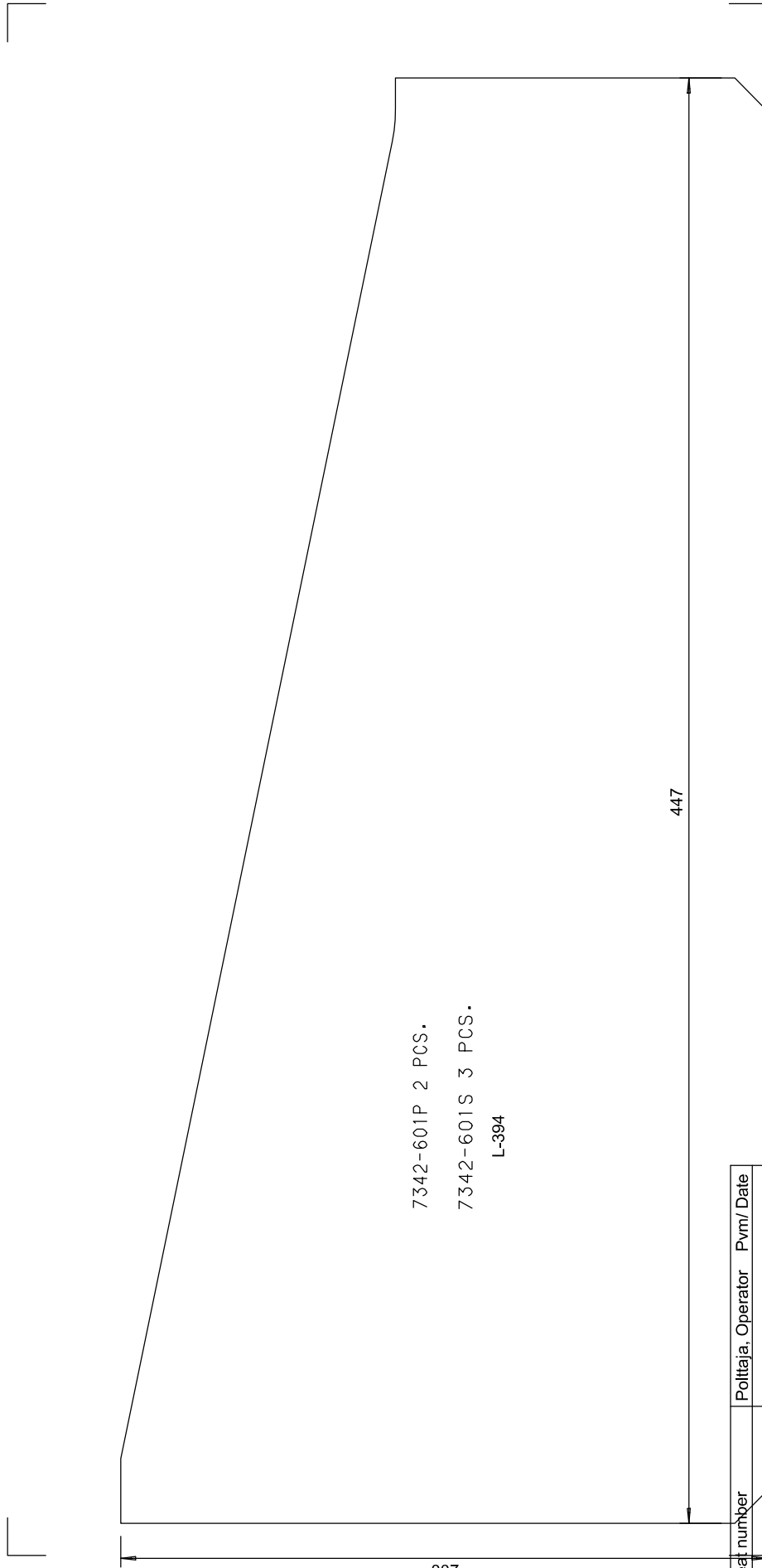
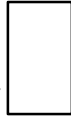

7342-601P 2 PCS.

7342-601S 3 PCS.

L-394

Sulatenumero, Heat number		Politeija, Operator		Pvm/ Date	
Nestattu levy (pituus*leveys*paksuus) Nested plate (length*width*thickness)	480* 235* 8	Laatu Quality	A36	Normaali Normal	1 kpl pcs.
Minimilevy (lisa +30/ +30) Minimumplate (add +30/ +30)	1013.* 486	Paino Weight	7.3 kg	Peilattu Mirrored	0 kpl pcs.
Valm.osa Comp.part	Nimellis Nominal	Ero Diff	Mittasi Measurer	Osia yht. Parts tot.	5 kpl pcs.
Pit./ Length				Jaannos/ Scrap	-212. %
Kork./ Height					
Nestasi/ Nested by	nurmha25	Pvm/ Date	2018-03-06	Laiva/ Ship	394
Leikk.aloituksia Burn.starts	1 kpl pcs.	Leikkuupituus Burn.length	1.2 m	Skaala/ Scale	1 : 1.4
Merkk.aloituksia Mark.starts	0 kpl pcs.	Merkkauuspituus Mark.length	0.0 m	Piirustus/ Drawing	D.394.0734.327.001
Autom.viist. Autom.bevel.	YES	Tyhjasiirtopituus Idle length	0.0 m	Suunn./ tark. Design/Check	
Postprosessoitu Postprocessing	NO			Nestinnimi/ Nesting name	KG7342-002
Koneksetit Machine texts	YES			Toimituspaikka ellei toisin naytetty	
	NO				

Detailt
Details

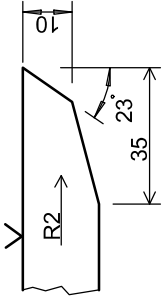

AP TAS 10.0 35mm, VA23
MANUAL BEVELLING

Ellei toisin n[]ytetty
If not stated otherwise

Hitsit/ Weldings

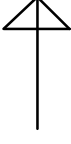

Puhd.aste
Prep. this side

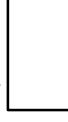

REST PLATE

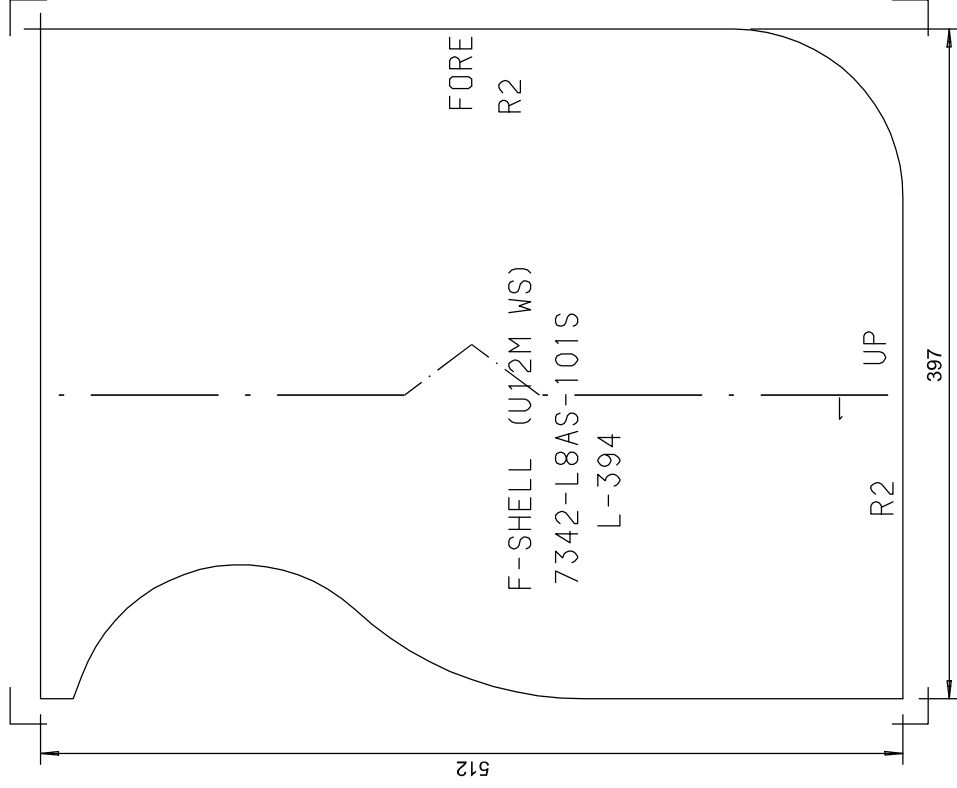

Sulatenumero, Heat number	Politteja, Operator	Pvm/ Date
Nestattu levy (pituus*leveys*paksuus) Nested plate (length*width*thickness) 430* 545* 20	Laatu Quality A36TM	Normaali Normal 1 kpl pcs.
Minimilevy (lisaa +30/ +30) Minimumplate (add +30/ +30) 397.4* 512.3	Paino Weight 38 kg	Peilattu Mirrored 0 kpl pcs.
Valm.osa Comp.part	Ero Diff	Mittasi Mittasur
Nimellis Nominal	Mittattu Measured	Osia yht. Parts tot. 1 kpl pcs.
Pit./ Length		Jaannos/ Scrap 19.6 %
Kork./ Height		

Leikkuupituus Burn.length 1.9 m	Leikk.aloituksia Burn.starts 1 kpl pcs.	Nestasi/ Nested by nurma25	Pvm/ Date 2018-03-06	Laiva/ Ship 394	Skaala/ Scale 1 : 3.1
Merkkäuspituus Mark.length 0.5 m <td>Merkk.aloituksia Mark.starts 1 kpl pcs.</td> <td>Suunn./ tark. Design/Check</td> <td>Pvm/ Date</td> <td>Piirustus/ Drawing D.394.0734.327.001</td> <td></td>	Merkk.aloituksia Mark.starts 1 kpl pcs.	Suunn./ tark. Design/Check	Pvm/ Date	Piirustus/ Drawing D.394.0734.327.001	
Tyhjäsiiroitus Idle length 1.3 m	Autom.viist. Autom.bevel. YES	Postprosessoitu Postprocessing	Pvm/ Date	Nestinnimi/ Nesting name PGN7342-002	
	NO				

Koneksetit Machine texts	YES	NO
Toimituspaikka ellei toisin näytetty		

Detail
Details

Ellei toisin n[]ytetty
If not stated otherwise

Hitsit/ Weldings



Puhd.aste
Prep. this side

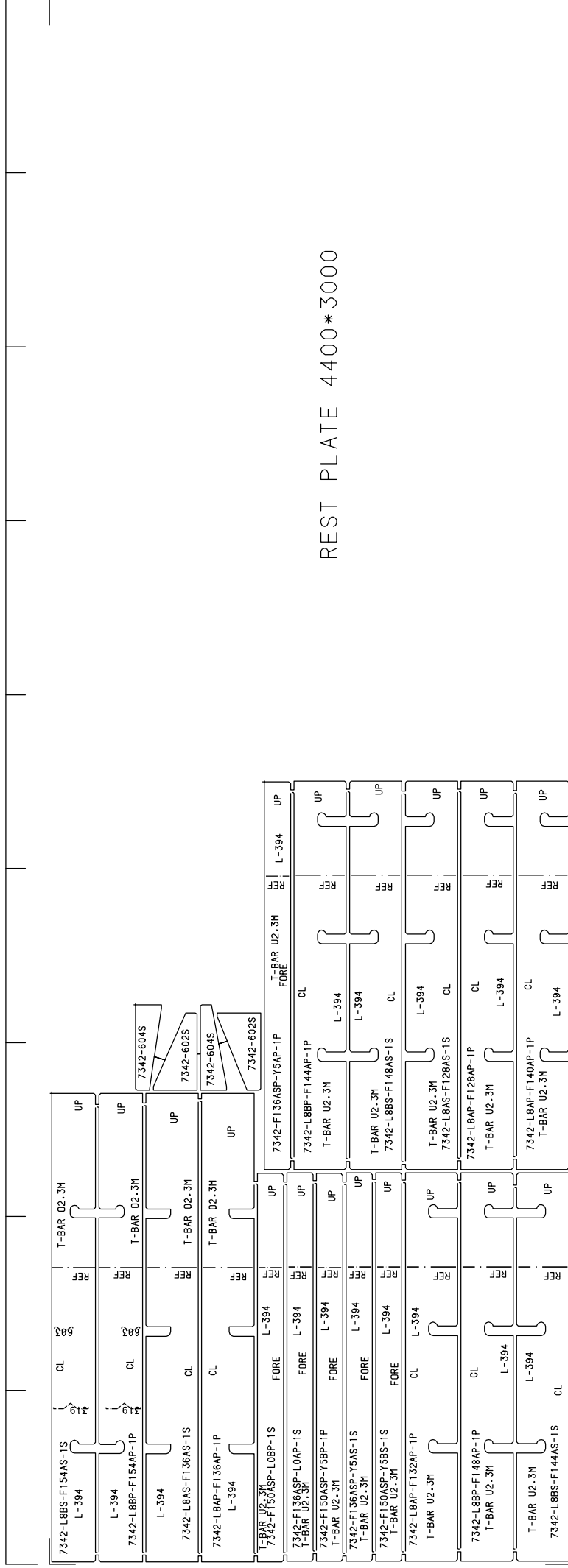
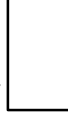

REST PLATE 4400*3000

Sulatenumero, Heat number	Poltteija, Operator		Pvm/ Date
Nestattu levy (pituus*leveys*paksuus) Nested plate (length*width*thickness) 9000* 3000* 8	Laatu Quality A	Normaali Normal 1 kpl pcs.	
Minimilevy (lisaa +30/+30) Minimumplate (add +30/+30) 4488* 2970	Paino Weight 1749.6 kg	Peliatu Mirrored 0 kpl pcs.	
Valm.osa Comp.part	Ero Mittasi Diff Measurer	Osa yht. Parts tot. 22 kpl pcs.	
Pit./ Length			
Kork./ Height		Jaannos/ Scrap 62.0 %	

Nestasi/ Nested by nurma25	Pvm/ Date 2018-03-06	Laiva/ Ship 394	7342	Skaala/ Scale 1 : 22.5
Leikk.aloituksia Burn.starts 35 kpl pcs.	Leikkuupituus Burn.length 108.5 m	Piirustus/ Drawing D.394.0734.327.001		
Merkk.aloituksia Mark.starts 22 kpl pcs.	Merkkäuspuitus Mark.length 4.9 m	Suunn./ tark. Design/Check		
Autom.viist. Autom.bevel. YES	Tyhjasiirtopituus Idle length 21.6 m	Postprosessointi Postprocessing		
YES		Nestinnimi/ Nesting name PGN7342_301		
NO				

Konek[]st Machine texts	YES	NO
Toimituspaikka ellei toisin naytetty		

Detail
Details

Ellei toisin näytetty
If not stated otherwise

Hitsit/
Weldings



Puhd.aste
Prep. this side

PG03

REST PLATE

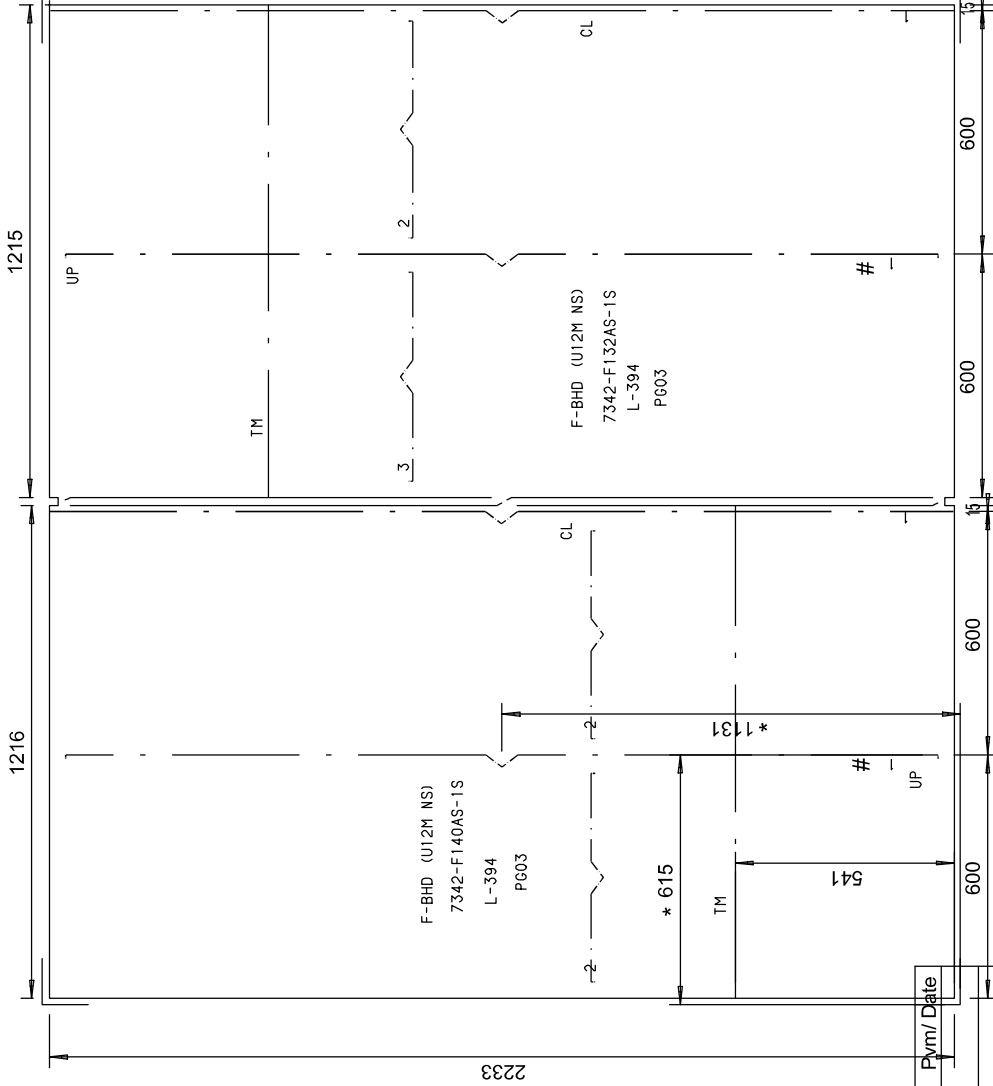

$$\text{U.N.O.} \quad \frac{4.0 \nabla 115 \nabla (415)}{4.0 \nabla 115 \nabla (415)}$$

$$\# = \frac{3.0 \nabla 115 \nabla (415)}{3.0 \nabla 115 \nabla (415)}$$

* = DIM. FROM THE RAW PLATE

Sulatenumero, Heat number		Poltteija, Operator		Pvm/ Date	
Nestattu levy (pituus*leveys*paksuus) Nested plate (length*width*thickness) 2485* 2265* 7		Laatu Quality A		Normaali Normal 1 kpl. pcs.	
Minimilevy (lisaa +30/ +30) Minimumplate (add +30/ +30) 2451* 2233		Paino Weight 319.1 kg		Peilattu Mirrored 0 kpl. pcs.	
Valm.osa Comp.part		Ero Diff		Osia yht. Parts tot. 2 kpl. pcs.	
Pit./ Length		Mittaus Measured		Tyhjasiirtoisuus Idle length 11.2 m	
Kork./ Height				Jaannos/ Scrap 3.5 %	
Nestasi/ Nested by nurma25		Nestasi/ Nested by Suunn./ tark. Design/Check		Leikk.aloituksia Burn.starts 5 kpl. pcs.	
Laiva/ Ship 394		Pvm/ Date 2018-03-09		Merkk.aloituksia Mark.starts 10 kpl. pcs.	
Skaala/ Scale 1 : 13.1		Pvm/ Date 2018-03-09		Autom.viist. Autom.bevel. YES	
Piiustus/ Drawing D.394.0734.327.001		Pvm/ Date		Autom.viist. Autom.bevel. NO	
Toimituspaikka ellei toisin näytetty		Nestinnimi/ Nesting name PGN7342_404		Konekset/ Machine texts YES <input checked="" type="checkbox"/> NO <input type="checkbox"/>	

Detail
Details

Ellei toisin n...yitetty
If not stated otherwise

Hitsit/ Weldings

Puhd.aste
Prep. this side

PG03

REST PLATE

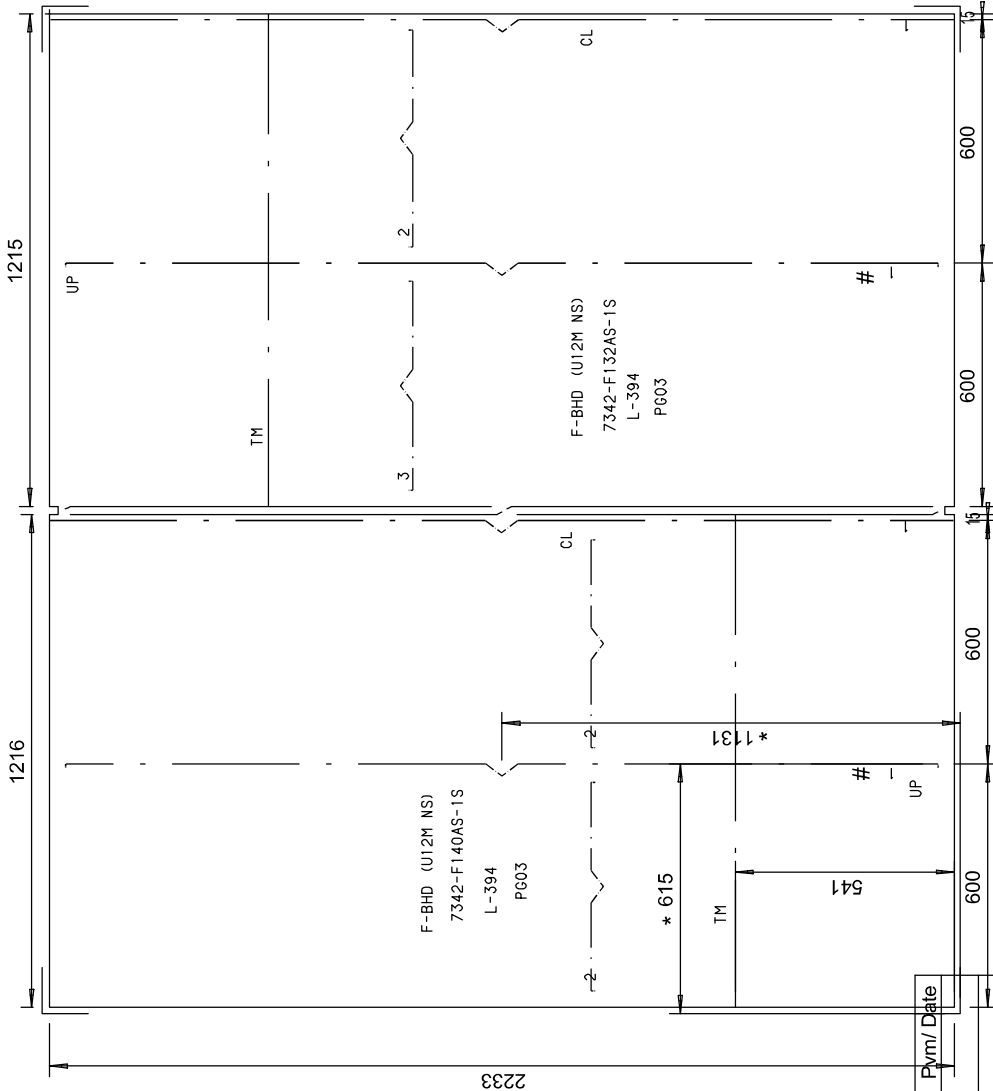

U.N.O. $\frac{4.0}{4.0} \frac{115}{115} \frac{(415)}{(415)}$

= $\frac{3.0}{3.0} \frac{115}{115} \frac{(415)}{(415)}$

* = DIM. FROM THE RAW PLATE

Sulatenumero, Heat number		Poltteija, Operator		Pvm/ Date	
Nestattu levy (pituus*leveys*paksuus) Nested plate (length*width*thickness) 2485* 2265* 7		Laatu Quality A		Normaali Normal 1 kpl. pcs.	
Minimilevy (lisaa +30/ +30) Minimumplate (add +30/ +30) 2451* 2233		Paino Weight 319.1 kg		Peilattu Mirrored 0 kpl. pcs.	
Valm.osa Comp.part		Ero Diff		Osia yht. Parts tot. 2 kpl. pcs.	
Pit./ Length		Mittaus Measured		Tyhjasiirtoisuus Idle length 11.2 m	
Kork./ Height				Jaannos/ Scrap 3.5 %	
		Nestasi/ Nested by nurma25		Pvm/ Date 2018-03-09	
		Leikk.aloituksia Burn.starts 5 kpl. pcs.		Leikk.aloituksia Mark.starts 10 kpl. pcs.	
		Leikkau pituus Burn.length 13.7 m		Merkk.aloituksia Mark.starts 10 kpl. pcs.	
		Merkkaus pituus Mark.length 13.6 m		Autom.viist. Autom.bevel. YES	
		Tyhjasiirtoisuus Idle length 11.2 m		Postprosessointi Postprocessing	
		Suunn./ tark. Design/Check		Pvm/ Date	
		Suunn./ tark. Design/Check		Pvm/ Date	
		Laiva/ Ship 394		Piiustus/ Drawing D.394.0734.327.001	
		Skaala/ Scale 1 : 13.1		Nestinnimi/ Nesting name PGN7342_404	
		7342		Toimituspaikka Machine texts YES <input checked="" type="checkbox"/> NO <input type="checkbox"/>	
				Toimituspaikka ellei toisin näytetty	

Detailt
Details

HAALAUVAUKKO VIISTETÄÄN VAIN ULKOREUNASTA, SISEMPI POLTTO ILMAN VIISTETTÄ.
TRANSPORTATION OPENING BEVEL ONLY OUTER SIDE, INNER WITHOUT BEVEL.



Ellei toisin n[ä]ytetty
If not stated otherwise

Hitsit/ Weldings



Puhd.aste
Prep. this side

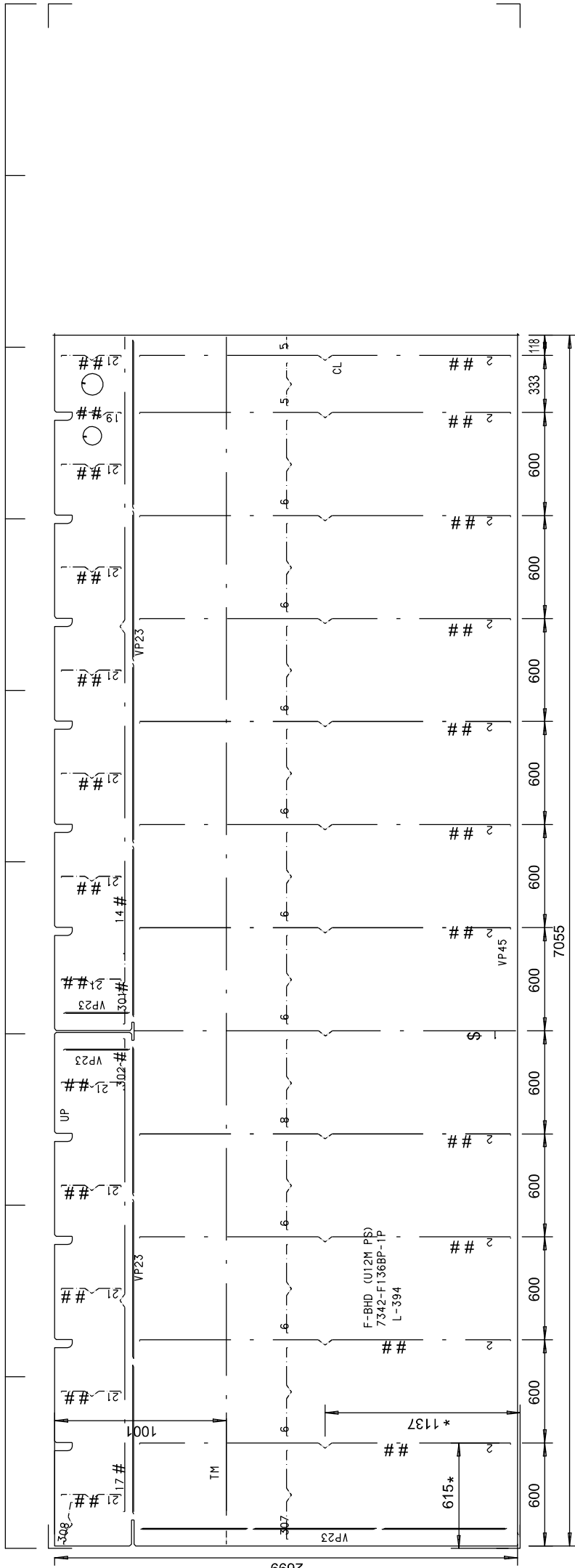
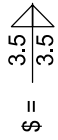



* = DIM. FROM THE RAW PLATE

Sulatenumero, Heat number		Poltteija, Operator		Pvm/ Date	
Nestattu levy (pituus*leveys*paksuus) Nested plate (length*width*thickness) 9000* 2750* 6		Laatu Quality	A	Normaali Normal	1 kpl. pcs.
Minimilevy (lisa +30/ +30) Minimumplate (add +30/ +30) 7054. * 2698.		Paino Weight	1202.9 kg	Peilattu Mirrored	0 kpl. pcs.
Valm.osa Comp.part	Mittattu Measured	Ero Diff	Mittasi Measurer	Osia yht. Parts tot.	1 kpl. pcs.
Pit./ Length	Kork./ Height	Jaannos/ Scrap	23.6 %		
Leikkuupituus Burn.length		Leikk.aloituksia Burn.starts		28 kpl. pcs.	
Merkkauspituus Mark.length		Merkk.aloituksia Mark.starts		45 kpl. pcs.	
Tyhjiäsiirtoitus Idle length		Autom.viist. Autom.bevel.		YES <input checked="" type="checkbox"/> NO <input type="checkbox"/>	
Nestasi/ Nested by		Pvm/ Date		Pvm/ Date	
nurma25		2018-03-07		2018-03-07	
Laiva/ Ship		Piiustus/ Drawing		Skaala/ Scale	
394		D.394.0734.327.001		1 : 22.5	
Nestitiin/ Nesting name		Konelekit Machine texts		Toimituspaikka ellei toisin näytetty	
Nestitiin nimi/ Nesting name		YES <input checked="" type="checkbox"/> NO <input type="checkbox"/>		PGN7342_451	

Detailt
Details

Ellei toisin n[]ytetty
If not stated otherwise

Hitsit/ Weldings 

Puhd.aste
Prep. this side 

U.N.O. $\frac{4.0 \nabla 115 \nabla (415)}{4.0 \nabla 115 \nabla (415)}$

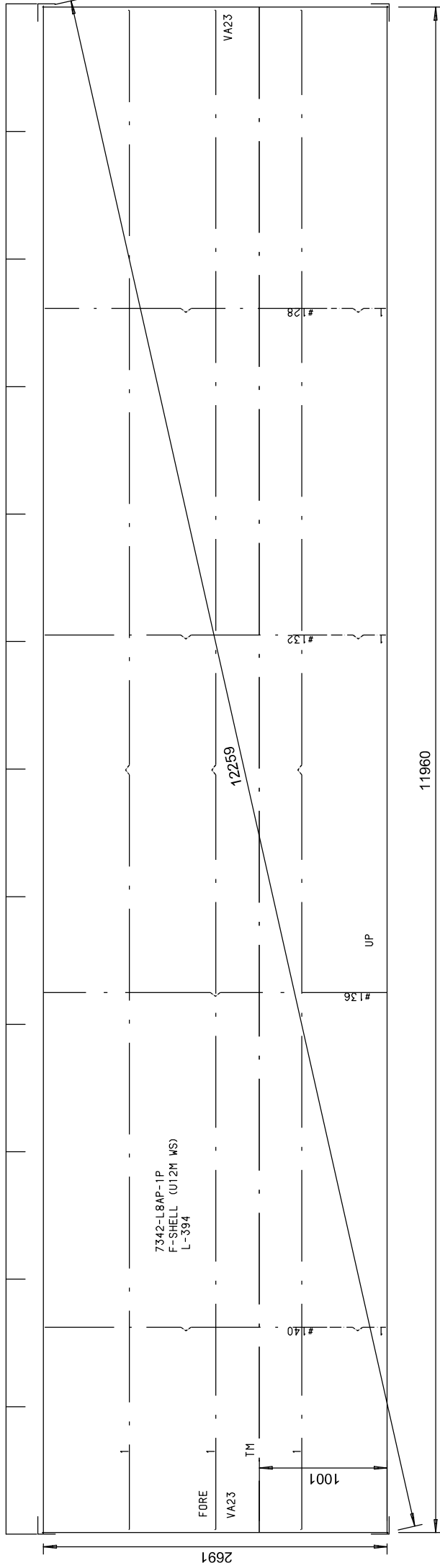

Sulatenumero, Heat number	Politeja, Operator	Pvm/ Date
Nestattu levy (pituus*leveys*paksuus) Nested plate (length*width*thickness) 12000* 2750* 10	Laatu Quality A36	Normaali Normal 1 kpl pcs.
Minimilevy (lisa +30/ +30) Minimuplate (add +30/ +30) 11960* 2691.	Paino Weight 2673 kg	Peilattu Mirrored 0 kpl pcs.
Valm.osa Comp.part	Ero Diff	Mittasi Measurer
Nimellis Nominal	Mittattu Measured	
Pit./ Length		
Kork./ Height		Jaannos/ Scrap 2.5 %
Nestasi/ Nested by nurma25	Pvm/ Date 2018-03-06	Laiva/ Ship 394
Leikk.aloituksia Burn.starts 1 kpl pcs.	Leikkuupituus Burn.length 29.4 m	Skaala/ Scale 1 : 29.9
Merkk.aloituksia Mark.starts 11 kpl pcs.	Merkkauspituus Mark.length 58.6 m	Piirustus/ Drawing D.394.0734.327.001
Autom.viist. Autom.bevel. YES X	Tyhjasiirtopituus Idle length 36.1 m	Nestinnimi/ Nesting name PGN7342-501
Postprosessoitu Postprocessing	Pvm/ Date	Toimituspaikka ellei toisin naytetty YES X NO

Detail
Details

Ellei toisin n[]ytetty
If not stated otherwise

Hitsit/ Weldings



Puhd.aste
Prep. this side

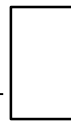

= $\frac{3.5}{3.5} \frac{115}{115} \frac{(415)}{(415)}$

U.N.O. $\frac{4.0}{4.0} \frac{115}{115} \frac{(415)}{(415)}$

PG03 THIS SIDE

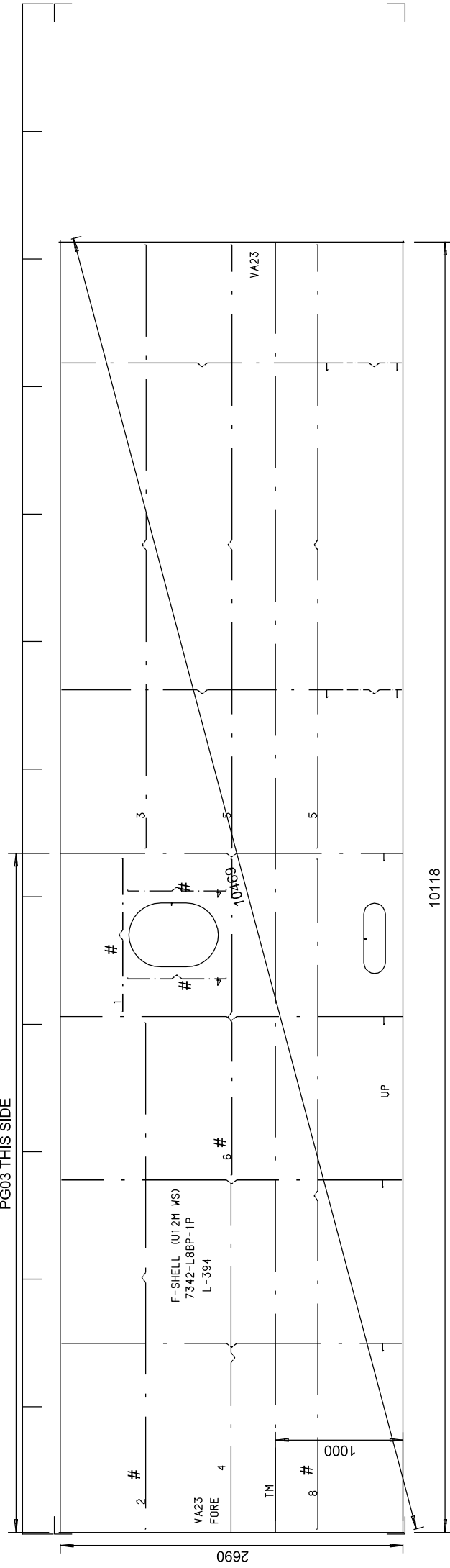

Sulatenumero, Heat number	Politteja, Operator	Pvm/ Date
Nestattu levy (pituus*leveys*paksuus) Nested plate (length*width*thickness)	Laatu Quality	Normaali Normal
12000* 2750* 10	A36	1 kpl. pcs.
Minimilevy (lisaa +30/ +30) Minimumplate (add +30/ +30)	Paino Weight	Peilattu Mirrored
10118* 2690	2673 kg	0 kpl. pcs.
Valm.osa Comp.part	Ero Diff	Osa yht. Parts tot.
Nimellis Nominal	Mittattu Measured	1 kpl. pcs.
Pit./ Length		
Kork./ Height		Jaannos/ Scrap
		18.7 %

Nestasi/ Nested by	Pvm/ Date	Laiva/ Ship	Skaala/ Scale
nurmha25	2018-03-09	394	1 : 29.9
Suunn./ tark. Design/Check	Pvm/ Date	Piirustus/ Drawing	
		D.394.0734.327.001	
Leikk.aloituksia Burn.starts	Leikkuupituus Burn.length	Merkk.aloituksia Mark.starts	Autom.viist. Autom.bevel
3 kpl. pcs.	29.1 m	19 kpl. pcs.	YES X
Merkk.aloituksia Mark.starts	Merkkauuspituus Mark.length	Tyhjasiirtopituus Idle length	NO
19 kpl. pcs.	58.0 m	28.3 m	
Autom.viist. Autom.bevel	Postprosessointi Postprocessing	Nestinnimi/ Nesting name	Toimituspaikka ellei toisin naytetty
YES X			
NO			

PGN7342-502

III. GAT nacrti_GN7341

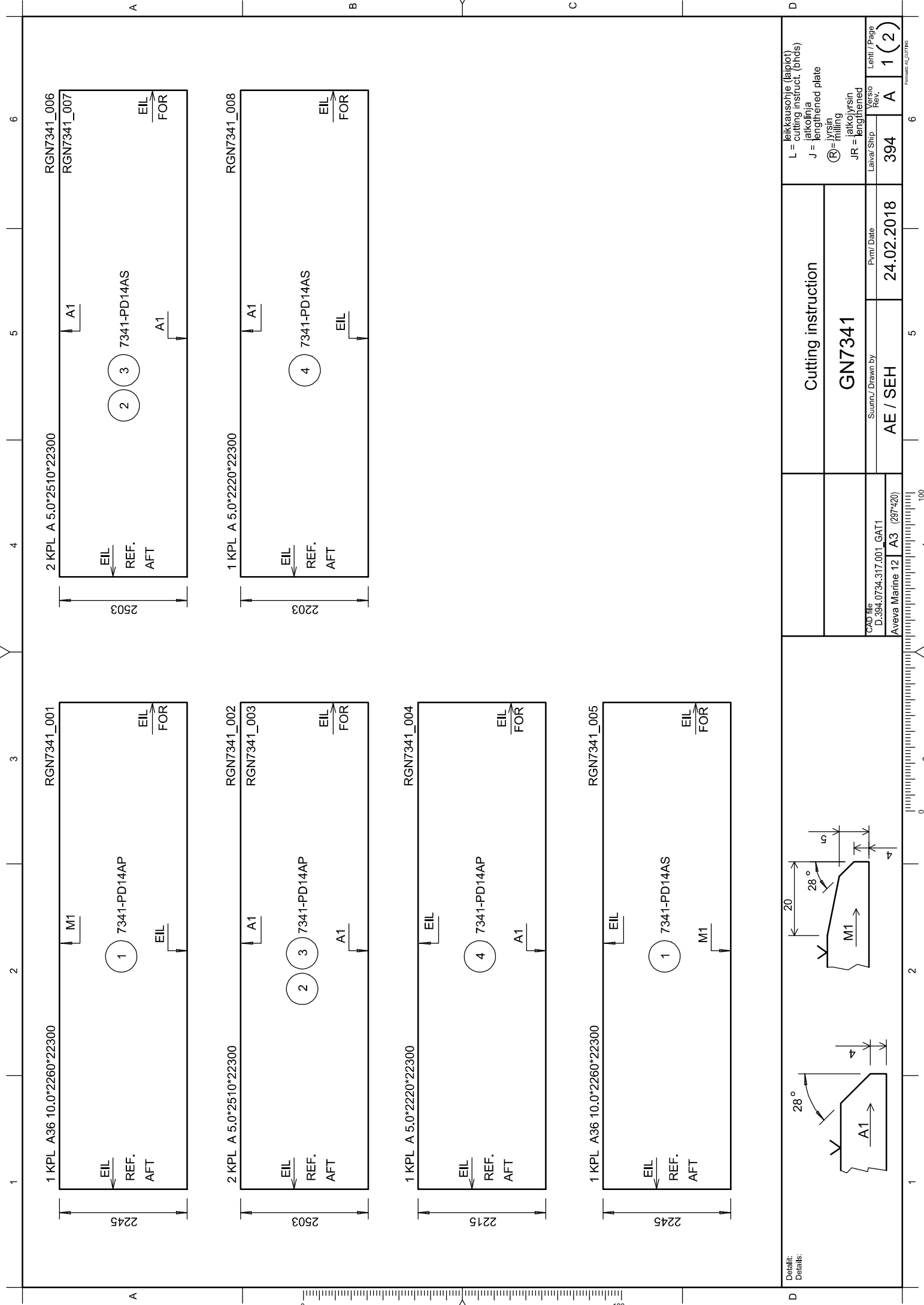

CAD file D.394.0734.317.001_GAT1		Summ./ Drawn by AE / SEH		Pymt/ Date 24.02.2018		Laituri / Page A 1 (2)	
Aveva Marine 12_A3 (297420)		GN7341		Cutting instruction		L = leikkausohje (leipäot) J = jatkolinja lengthened plate (R) = jyrsin milling JR = jatkojyrsin lengthened	
394		394		394		394	

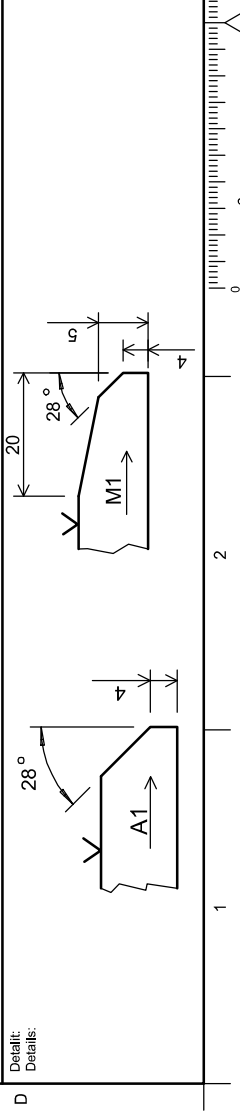

IV. GN7342Wcog -lista

Part name	Weight	X	Y	Z	Type	Side	Quality	Nested on	Circ. Length	Circ. Width	Thickness	Shape	Dimension	Total Length
7342-601S	4.6	96518.7	-4158.1	41724	PLANAR PLATE BRACKET	SB	A36	KG7342_002	447	200	800.000			
7342-601P	4.6	96518.7	4158.1	41049	PLANAR PLATE BRACKET	PS	A36	KG7342_002	447	200	800.000			
7342-601P	4.6	96518.7	4158.1	41724	PLANAR PLATE BRACKET	PS	A36	KG7342_002	447	200	800.000			
7342-601S	4.6	96518.7	-4158.1	40374	PLANAR PLATE BRACKET	SB	A36	KG7342_002	447	200	800.000			
7342-601S	4.6	96518.7	-4158.1	41049	PLANAR PLATE BRACKET	SB	A36	KG7342_002	447	200	800.000			
7342-801S	1.6	96680.9	-4306.1	40375	PLANAR PLATE BRACKET	SB	A36		200	200	800.000			
7342-801P	1.6	96680.9	4306.1	41725	PLANAR PLATE BRACKET	PS	A36		200	200	800.000			
7342-801P	1.6	96680.9	4306.1	41050	PLANAR PLATE BRACKET	PS	A36		200	200	800.000			
7342-801S	1.6	96680.9	-4306.1	41725	PLANAR PLATE BRACKET	SB	A36		200	200	800.000			
7342-801S	1.6	96680.9	-4306.1	41050	PLANAR PLATE BRACKET	SB	A36		200	200	800.000			
7342-603P	1.3	99068.3	4332.4	41054	PLANAR PLATE BRACKET	PS	A36	PG7342_001	240	125	800.000			
7342-603S	1.3	99068.3	-4332.4	41054	PLANAR PLATE BRACKET	SB	A36	PG7342_001	240	125	800.000			
7342-8814S	26.6	85052.4	-4512.5	41730.4	PLANAR PLATE BRACKET	SB	A36		740	482.4	2,500.000			
7342-882P	0.6	87584	4423.4	41689	PLANAR PLATE COLLAR	PS	A36		162	65	800.000			
7342-882P	0.6	87584	4423.4	40339	PLANAR PLATE COLLAR	PS	A36		162	65	800.000			
7342-882P	0.6	87584	4423.4	41014	PLANAR PLATE COLLAR	PS	A36		162	65	800.000			
7342-882S	0.6	87568	-4423.4	41689	PLANAR PLATE COLLAR	SB	A36		162	65	800.000			
7342-882S	0.6	87568	-4423.4	40339	PLANAR PLATE COLLAR	SB	A36		162	65	800.000			
7342-882S	0.6	87568	-4423.4	41014	PLANAR PLATE COLLAR	SB	A36		162	65	800.000			
7342-751S	2.8	87569.5	-2743.6	42168.4	PLANAR PLATE COLLAR	SB	A	KG7342_001	480	108	700.000			
7342-751P	2.8	87583.5	2866.4	42168.4	PLANAR PLATE COLLAR	PS	A	KG7342_001	480	108	700.000			
7342-751P	2.8	87583.5	2743.6	42168.4	PLANAR PLATE COLLAR	PS	A	KG7342_001	480	108	700.000			
7342-751P	2.8	87583.5	66.4	42168.4	PLANAR PLATE COLLAR	PS	A	KG7342_001	480	108	700.000			
7342-751S	2.8	87583.5	-56.4	42168.4	PLANAR PLATE COLLAR	SB	A	KG7342_001	480	108	700.000			
7342-751S	2.8	87569.5	-2866.4	42168.4	PLANAR PLATE COLLAR	SB	A	KG7342_001	480	108	700.000			
7342-880S	0.4	87568	-1539.3	42342.3	PLANAR PLATE COLLAR	SB	A36		122	61.5	800.000			
7342-880S	0.4	87568	-339.3	42342.3	PLANAR PLATE COLLAR	SB	A36		122	61.5	800.000			
7342-880S	0.4	87568	-939.3	42342.3	PLANAR PLATE COLLAR	SB	A36		122	61.5	800.000			
7342-880P	0.4	87586	5139.3	42342.3	PLANAR PLATE COLLAR	PS	A36		122	61.5	800.000			
7342-880P	0.4	87582	12939.3	42342.3	PLANAR PLATE COLLAR	PS	A36		122	61.5	800.000			
7342-880P	0.4	87582	12339.3	42342.3	PLANAR PLATE COLLAR	PS	A36		122	61.5	800.000			
7342-880P	0.4	87582	11739.3	42342.3	PLANAR PLATE COLLAR	PS	A36		122	61.5	800.000			
7342-880P	0.4	87582	11139.3	42342.3	PLANAR PLATE COLLAR	PS	A36		122	61.5	800.000			
7342-880P	0.4	87582	9939.3	42342.3	PLANAR PLATE COLLAR	PS	A36		122	61.5	800.000			
7342-880P	0.4	87582	9339.3	42342.3	PLANAR PLATE COLLAR	PS	A36		122	61.5	800.000			
7342-880P	0.4	87582	8739.3	42342.3	PLANAR PLATE COLLAR	PS	A36		122	61.5	800.000			
7342-880P	0.4	87582	8139.3	42342.3	PLANAR PLATE COLLAR	PS	A36		122	61.5	800.000			
7342-880P	0.4	87582	7539.3	42342.3	PLANAR PLATE COLLAR	PS	A36		122	61.5	800.000			
7342-880P	0.4	87582	6939.3	42342.3	PLANAR PLATE COLLAR	PS	A36		122	61.5	800.000			
7342-880P	0.4	87586	6339.3	42342.3	PLANAR PLATE COLLAR	PS	A36		122	61.5	800.000			

7342-880P	0.4	87586	5739.3	42342.3	PLANAR PLATE COLLAR	PS	A36		122	61.5	800.000		
7342-880S	0.4	87568	-5139.3	42342.3	PLANAR PLATE COLLAR	SB	A36		122	61.5	800.000		
7342-880S	0.4	87568	-12939.3	42342.3	PLANAR PLATE COLLAR	SB	A36		122	61.5	800.000		
7342-880S	0.4	87568	-12339.3	42342.3	PLANAR PLATE COLLAR	SB	A36		122	61.5	800.000		
7342-880S	0.4	87568	-11739.3	42342.3	PLANAR PLATE COLLAR	SB	A36		122	61.5	800.000		
7342-880S	0.4	87568	-11139.3	42342.3	PLANAR PLATE COLLAR	SB	A36		122	61.5	800.000		
7342-880S	0.4	87568	-9939.3	42342.3	PLANAR PLATE COLLAR	SB	A36		122	61.5	800.000		
7342-880S	0.4	87568	-9339.3	42342.3	PLANAR PLATE COLLAR	SB	A36		122	61.5	800.000		
7342-880S	0.4	87568	-8739.3	42342.3	PLANAR PLATE COLLAR	SB	A36		122	61.5	800.000		
7342-880S	0.4	87568	-8139.3	42342.3	PLANAR PLATE COLLAR	SB	A36		122	61.5	800.000		
7342-880S	0.4	87568	-7539.3	42342.3	PLANAR PLATE COLLAR	SB	A36		122	61.5	800.000		
7342-880S	0.4	87568	-6939.3	42342.3	PLANAR PLATE COLLAR	SB	A36		122	61.5	800.000		
7342-880S	0.4	87568	-6339.3	42342.3	PLANAR PLATE COLLAR	SB	A36		122	61.5	800.000		
7342-880S	0.4	87568	-5739.3	42342.3	PLANAR PLATE COLLAR	SB	A36		122	61.5	800.000		
7342-881P	0.5	97884	4432.8	41692	PLANAR PLATE COLLAR	PS	A36		142	63	800.000		
7342-881P	0.5	97884	4432.8	41017	PLANAR PLATE COLLAR	PS	A36		142	63	800.000		
7342-751S	2.8	86583.5	-56.4	42168.4	PLANAR PLATE COLLAR	SB	A	KGN7342_001	480	108	700.000		
7342-751P	2.8	86583.5	66.4	42168.4	PLANAR PLATE COLLAR	PS	A	KGN7342_001	480	108	700.000		
7342-751S	2.8	88583.5	-56.4	42168.4	PLANAR PLATE COLLAR	SB	A	KGN7342_001	480	108	700.000		
7342-751P	2.8	88583.5	66.4	42168.4	PLANAR PLATE COLLAR	PS	A	KGN7342_001	480	108	700.000		
7342-L8AP-F128	41.5	82224	4347.1	40816.4	PLANAR PLATE PLANE	PS	A	PGN7342_301	2232.2	300	800.000		
7342-L8AS-F128	41.5	82224	-4347.1	40816.4	PLANAR PLATE PLANE	SB	A	PGN7342_301	2232.2	300	800.000		
7342-L8AP-F132	41.5	84784	4347.1	40816.4	PLANAR PLATE PLANE	PS	A	PGN7342_301	2232.2	300	800.000		
7342-F132AS-1S	153.9	84783.5	-3892.1	40826.5	PLANAR PLATE PLANE	SB	A	PGN7342_404	2233	1215.8	700.000		
7342-L8AP-F136	50.9	87584	4347.7	41056.9	PLANAR PLATE PLANE	PS	A	PGN7342_301	2692.6	300	800.000		
7342-L8AS-F136	50.9	87584	-4347.7	41056.9	PLANAR PLATE PLANE	SB	A	PGN7342_301	2692.6	300	800.000		
7342-F136ASP-1S	1262	87583.5	4.9	41041.4	PLANAR PLATE PLANE	CL	A	PGN7342_401	8385.5	2693.6	700.000		
7342-F136BP-1P	918.7	87583	9978.4	41043.5	PLANAR PLATE PLANE	PS	A	PGN7342_451	7054.9	2698.9	600.000		
7342-F136BP-2P	205.4	87585	5483.9	41320.2	PLANAR PLATE PLANE	PS	A36	PGN7342_453	2698.9	1941.3	1.000.000		
7342-F136BS-1S	918.7	87583	-9978.4	41047.4	PLANAR PLATE PLANE	SB	A	PGN7342_452	7054.9	2698.9	600.000		
7342-F136BS-2S	209.9	87585	-5482	41334.4	PLANAR PLATE PLANE	SB	A36	PGN7342_453	2693.9	1941.3	1.000.000		
7342-L8AP-F140	41.5	90204	4347.1	40816.4	PLANAR PLATE PLANE	PS	A	PGN7342_301	2232.2	300	800.000		
7342-F140AS-1S	153.9	90203.5	-3892.9	40826.5	PLANAR PLATE PLANE	SB	A	PGN7342_404	2233	1215.8	700.000		
7342-L8BP-F144	41.5	92764	4347.1	40816.4	PLANAR PLATE PLANE	PS	A	PGN7342_301	2232.2	300	800.000		
7342-L8BS-F144	41.5	92764	-4347.1	40816.4	PLANAR PLATE PLANE	SB	A	PGN7342_301	2232.2	300	800.000		
7342-L8BP-F148	41.5	95324	4347.1	40816.4	PLANAR PLATE PLANE	PS	A	PGN7342_301	2232.2	300	800.000		
7342-L8BS-F148	41.5	95324	-4347.1	40816.4	PLANAR PLATE PLANE	SB	A	PGN7342_301	2232.2	300	800.000		
7342-F150ASP-1S	1374.9	96603.5	2.1	41057.4	PLANAR PLATE PLANE	CL	A	PGN7342_402	9005.9	2693.6	700.000		
7342-F152AP-1P	230.8	97883.5	3741.2	41056.4	PLANAR PLATE PLANE	PS	A	PGN7342_403	2693.6	1516	700.000		
7342-L8BS-F152	52.6	97885	-4373.2	41056.7	PLANAR PLATE PLANE	SB	A	PGN7342_453	2692.2	250	1.000.000		
7342-L8BP-F154	42.6	99164	4373.8	41056.7	PLANAR PLATE PLANE	PS	A	PGN7342_301	2692.6	250	800.000		

7342-L8BS-F154A	42.6	99164	-4373.8	41056.7	PLANAR PLATE PLANE	SB	A		PGN7342_301	2692.6	250	800.000					
7342-L8BP-F156A	53.2	100445	4373.8	41056.5	PLANAR PLATE PLANE	PS	A		PGN7342_453	2692.2	250	1.000.000					
7342-L8BS-F156A	53.2	100445	-4373.8	41056.5	PLANAR PLATE PLANE	SB	A		PGN7342_453	2692.2	250	1.000.000					
7342-F136ASP-1C	21.7	87505	4	40826.2	PLANAR PLATE PLANE	PS	A		PGN7342_301	2232.4	150	800.000					
7342-F150ASP-1C	21.7	96525	4	40826.2	PLANAR PLATE PLANE	PS	A		PGN7342_301	2232.4	150	800.000					
7342-LIAP-1P	151.8	87083.8	303.5	41056.8	PLANAR PLATE PLANE	PS	A		PGN7342_403	2693.6	993.7	700.000					
7342-LIBP-1P	151.8	88083.2	303.5	41056.8	PLANAR PLATE PLANE	PS	A		PGN7342_403	2693.6	993.7	700.000					
7342-L4AS-1S	151.8	87083.8	-2103.5	41056.8	PLANAR PLATE PLANE	SB	A		PGN7342_403	2693.6	993.7	700.000					
7342-L4BS-1S	151.8	88083.2	-2103.5	41056.8	PLANAR PLATE PLANE	SB	A		PGN7342_403	2693.6	993.7	700.000					
7342-L6AS-1S	92.8	85434.4	-3303.5	41362.8	PLANAR PLATE PLANE	SB	A		PGN7342_402	2691.8	1294.7	700.000					
7342-L6BS-1S	74.6	89637.2	-3303.5	41439.5	PLANAR PLATE PLANE	SB	A		PGN7342_402	2691.8	1174.6	700.000					
7342-L8AP-1P	2607.3	85827.9	4505	41054.3	PLANAR PLATE PLANE	PS	A36		PGN7342_501	11960.2	2691.4	1.000.000					
7342-L8AS-1S	2272.7	85575.7	-4505	41093.9	PLANAR PLATE PLANE	SB	A36		PGN7342_504	11960.2	2691.4	1.000.000					
7342-L8AS-101S	30.5	90227.8	-4510	39972.1	PLANAR PLATE PLANE	SB	A36		PGN7342_002	512.3	397.4	2.000.000					
7342-L8BP-1P	2173.6	96855.4	4505	41056.4	PLANAR PLATE PLANE	PS	A36		PGN7342_502	10118.3	2690	1.000.000					
7342-L8BS-1S	2205.8	96871.2	-4505	41055.7	PLANAR PLATE PLANE	SB	A36		PGN7342_503	10118.3	2691.4	1.000.000					
7342-X133AS-1S	189.5	86083.5	-3905.4	41056.8	PLANAR PLATE PLANE	SB	A		PGN7342_403	2693.6	1240.8	700.000					
7342-X135ASP-1	263.5	86583.5	-1157.6	41142.9	PLANAR PLATE PLANE	CL	A		PGN7342_401	2693.6	2445.6	700.000					
7342-X137ASP-1	263.5	88583.5	-1157.6	41142.9	PLANAR PLATE PLANE	CL	A		PGN7342_403	2693.6	2445.6	700.000					
7342-X138AS-1S	189.5	89023.5	-3905.4	41056.8	PLANAR PLATE PLANE	SB	A		PGN7342_403	2693.6	1240.8	700.000					
7342-F136ASP-Y	21.7	87505	2804	40828.2	PLANAR PLATE PLANE	PS	A		PGN7342_301	2228.4	150	800.000					
7342-F136ASP-Y	21.7	87505	-2804	40826.2	PLANAR PLATE PLANE	SB	A		PGN7342_301	2232.4	150	800.000					
7342-F150ASP-Y	21.7	96525	2804	40828.2	PLANAR PLATE PLANE	PS	A		PGN7342_301	2228.4	150	800.000					
7342-F150ASP-Y	21.7	96525	-2804	40826.2	PLANAR PLATE PLANE	SB	A		PGN7342_301	2232.4	150	800.000					
7342-Y6AP-1P	194.3	97243.9	3003.5	41058.8	PLANAR PLATE PLANE	PS	A		PGN7342_403	2689.6	1273.8	700.000					
7342-604S	3.7	89087.1	-3626.4	41944	PLANAR PLATE PLANE	SB	A		PGN7342_301	490	150	800.000					
7342-602S	4.8	89119.2	-4167.7	41944	PLANAR PLATE PLANE	SB	A		PGN7342_301	442	250	800.000					
7342-604S	3.5	86022.4	-3618.9	41944	PLANAR PLATE PLANE	SB	A		PGN7342_301	490	150	800.000					
7342-602S	4.6	85989.6	-4173	41944	PLANAR PLATE PLANE	SB	A		PGN7342_301	442	250	800.000					
7342-L8AP-F128A	18	82224	4200	40825	PROFILE PLANE	PS	A						LAT	100*10.0	2228		
7342-L8AS-F128A	18	82224	-4200	40825	PROFILE PLANE	SB	A						LAT	100*10.0	2228		
7342-L8AP-F132A	18	84784	4200	40824.1	PROFILE PLANE	PS	A						LAT	100*10.0	2228		
7342-F132AS1S	10.9	84846.6	-3904.7	40825	PROFILE PLANE	SB	A36						BE	100*5.0	2150		
7342-F132AS3S	2.2	84823	-4202.5	41049	PROFILE PLANE	SB	A						LAT	80*8.0	515		
7342-F132AS2S	2.1	84822.3	-3592.5	41049	PROFILE PLANE	SB	A						LAT	80*8.0	535		
7342-L8AP-F136A	21.8	87584	4200	41055	PROFILE PLANE	PS	A						LAT	100*10.0	2688		
7342-L8AS-F136A	21.8	87584	-4200	41055	PROFILE PLANE	SB	A						LAT	100*10.0	2688		
7342-F136ASP2S	26.6	87501	-2506.1	41055	PROFILE PLANE	SB	A36						BE	140*8.0	2610		
7342-F136ASP2S	26.6	87501	-3906.1	41055	PROFILE PLANE	SB	A36						BE	140*8.0	2610		
7342-F136ASP2S	26.6	87501	-3306.1	41055	PROFILE PLANE	SB	A36						BE	140*8.0	2610		
7342-F136ASP3P	26.5	87501	3306.1	41057	PROFILE PLANE	PS	A36						BE	140*8.0	2606		

7342-F136ASP2P	26.6	87501	3906.1	41055	PROFILE PLANE	PS	A36					BE	140*8.0	2610
7342-F136ASP3P	26.5	87501	906.1	41057	PROFILE PLANE	PS	A36					BE	140*8.0	2606
7342-F136ASP3P	26.5	87501	1506.1	41057	PROFILE PLANE	PS	A36					BE	140*8.0	2606
7342-F136ASP3P	26.5	87501	2106.1	41057	PROFILE PLANE	PS	A36					BE	140*8.0	2606
7342-F136ASP3P	26.5	87501	2506.1	41057	PROFILE PLANE	PS	A36					BE	140*8.0	2606
7342-F136ASP1S	25.5	87501.1	-306.1	41005	PROFILE PLANE	SB	A36					BE	140*8.0	2510
7342-F136ASP1S	25.5	87501.1	-906.1	41005	PROFILE PLANE	SB	A36					BE	140*8.0	2510
7342-F136ASP1S	25.5	87501.1	-1506.1	41005	PROFILE PLANE	SB	A36					BE	140*8.0	2510
7342-F136BP14P	68.8	87505.4	8161.2	41997.5	PROFILE PLANE	PS	A					LAT	150*15.0	3809
7342-F136BP17P	43	87506.3	12024.3	41997.5	PROFILE PLANE	PS	A					LAT	150*15.0	2456
7342-F136BP1P	37.4	87509.2	10505.5	40828.9	PROFILE PLANE	PS	A					T	100*100*1	2234
7342-303P	17.2	87597.5	9936	39716.5	PROFILE PLANE	PS	A					L	40*40*4.0	6972
7342-F136BP13P	14.4	87521	5479.2	41995	PROFILE PLANE	PS	A					LAT	120*10.0	1518
7342-F136BP9P	13.4	87520	4714.7	41055	PROFILE PLANE	PS	A36					BE	100*5.0	2610
7342-F136BP4P	11.6	87519.5	6239.8	40882.9	PROFILE PLANE	PS	A36					BE	100*5.0	2192
7342-F136BP2P	11	87520.3	6904.7	40825	PROFILE PLANE	PS	A36					BE	100*5.0	2160
7342-F136BP2P	11	87520.3	6572.2	40825	PROFILE PLANE	PS	A36					BE	100*5.0	2160
7342-F136BP2P	11	87520.3	12904.7	40825	PROFILE PLANE	PS	A36					BE	100*5.0	2160
7342-F136BP2P	11	87520.3	12304.7	40825	PROFILE PLANE	PS	A36					BE	100*5.0	2160
7342-F136BP2P	11	87520.3	11704.7	40825	PROFILE PLANE	PS	A36					BE	100*5.0	2160
7342-F136BP2P	11	87520.3	11104.7	40825	PROFILE PLANE	PS	A36					BE	100*5.0	2160
7342-F136BP2P	11	87520.3	9904.7	40825	PROFILE PLANE	PS	A36					BE	100*5.0	2160
7342-F136BP2P	11	87520.3	9304.7	40825	PROFILE PLANE	PS	A36					BE	100*5.0	2160
7342-F136BP2P	11	87520.3	8704.7	40825	PROFILE PLANE	PS	A36					BE	100*5.0	2160
7342-F136BP2P	11	87520.3	8104.7	40825	PROFILE PLANE	PS	A36					BE	100*5.0	2160
7342-F136BP2P	11	87520.3	7504.7	40825	PROFILE PLANE	PS	A36					BE	100*5.0	2160
7342-305P	10.3	87589	8353.5	41895	PROFILE PLANE	PS	A					LAT	50*6.0	4233
7342-304P	6.9	87589	11993	41945	PROFILE PLANE	PS	A					LAT	50*6.0	2858
7342-301P	5.7	87514.9	10214.4	41997.5	PROFILE PLANE	PS	A					LAT	150*15.0	410
7342-306P	5.3	87589	13347	40828	PROFILE PLANE	PS	A					LAT	50*6.0	2164
7342-302P	3.6	87520.5	10731.4	41997.5	PROFILE PLANE	PS	A					LAT	150*15.0	297
7342-307P	2.3	87543.6	13202.5	41046	PROFILE PLANE	PS	A					LAT	80*8.0	515
7342-F136BP20P	1.9	87523.4	6239.4	42117.3	PROFILE PLANE	PS	A36					BE	100*5.0	418
7342-F136BP21P	1.5	87524.4	9604.3	42150.3	PROFILE PLANE	PS	A36					BE	100*5.0	354
7342-F136BP21P	1.5	87524.4	13204.3	42150.3	PROFILE PLANE	PS	A36					BE	100*5.0	354
7342-F136BP21P	1.5	87524.4	12604.3	42150.3	PROFILE PLANE	PS	A36					BE	100*5.0	354
7342-F136BP21P	1.5	87524.4	12004.3	42150.3	PROFILE PLANE	PS	A36					BE	100*5.0	354
7342-F136BP21P	1.5	87524.4	11404.3	42150.3	PROFILE PLANE	PS	A36					BE	100*5.0	354
7342-F136BP21P	1.5	87524.4	10804.3	42150.3	PROFILE PLANE	PS	A36					BE	100*5.0	354
7342-F136BP21P	1.5	87524.4	10204.3	42150.3	PROFILE PLANE	PS	A36					BE	100*5.0	354
7342-F136BP21P	1.5	87524.4	9004.3	42150.3	PROFILE PLANE	PS	A36					BE	100*5.0	354

7342-F136BP21P	1.5	87524.4	8404.3	42150.3	PROFILE PLANE	PS	A36					BE	100*5.0	354
7342-F136BP21P	1.5	87524.4	7804.3	42150.3	PROFILE PLANE	PS	A36					BE	100*5.0	354
7342-F136BP21P	1.5	87524.4	7204.3	42150.3	PROFILE PLANE	PS	A36					BE	100*5.0	354
7342-F136BP21P	1.5	87524.4	6571.8	42150.3	PROFILE PLANE	PS	A36					BE	100*5.0	354
7342-F136BP6P	2.3	87543.6	12602.5	41046	PROFILE PLANE	PS	A					LAT	80*8.0	515
7342-F136BP6P	2.3	87543.6	11402.5	41046	PROFILE PLANE	PS	A					LAT	80*8.0	515
7342-F136BP6P	2.3	87543.6	7202.5	41046	PROFILE PLANE	PS	A					LAT	80*8.0	515
7342-F136BP6P	2.3	87543.6	7802.5	41046	PROFILE PLANE	PS	A					LAT	80*8.0	515
7342-F136BP6P	2.3	87543.6	8402.5	41046	PROFILE PLANE	PS	A					LAT	80*8.0	515
7342-F136BP6P	2.3	87543.6	9002.5	41046	PROFILE PLANE	PS	A					LAT	80*8.0	515
7342-F136BP6P	2.3	87543.6	9602.5	41046	PROFILE PLANE	PS	A					LAT	80*8.0	515
7342-F136BP6P	2.3	87543.6	10202.5	41046	PROFILE PLANE	PS	A					LAT	80*8.0	515
7342-F136BP8P	2.2	87543.6	10805.5	41046	PROFILE PLANE	PS	A					LAT	80*8.0	509
7342-F136BP6P	2.3	87543.6	12002.5	41046	PROFILE PLANE	PS	A					LAT	80*8.0	515
7342-F136BP5P	0.9	87549.2	6403.7	41046	PROFILE PLANE	PS	A					LAT	80*8.0	247
7342-308P	1.1	87543.5	13388.3	42326	PROFILE PLANE	PS	A					LAT	80*8.0	257
7342-F136BP19P	0.9	87531.1	6903.5	42115.7	PROFILE PLANE	PS	A36					BE	100*5.0	264
7342-F136BP18P	1	87530.7	5703.6	42113	PROFILE PLANE	PS	A36					BE	100*5.0	269
7342-F136BP18P	1	87530.7	5103.6	42113	PROFILE PLANE	PS	A36					BE	100*5.0	269
7342-F136BP12P	0.6	87547.4	4642.5	41994	PROFILE PLANE	PS	A					LAT	80*8.0	159
7342-F136BP5P	0.9	87549.2	6736.2	41046	PROFILE PLANE	PS	A					LAT	80*8.0	248
7342-308P	1.1	87622.5	13388.3	42326	PROFILE PLANE	PS	A					LAT	80*8.0	257
7342-F136BS18S	71	87505.4	-8216.4	41997.5	PROFILE PLANE	SB	A					LAT	150*15.0	3925
7342-F136BS21S	43.1	87506.3	-12027.9	41997.5	PROFILE PLANE	SB	A					LAT	150*15.0	2464
7342-F136BS1S	37.4	87509.2	-10509	40828.9	PROFILE PLANE	SB	A					T	100*100*1	2234
7342-311S	17.2	87597.5	-9936	39716.5	PROFILE PLANE	SB	A					L	40*40*4.0	6972
7342-F136BS17S	14.4	87521	-5477.7	41995	PROFILE PLANE	SB	A					LAT	120*10.0	1515
7342-F136BS13S	13.4	87520.1	-4714.7	41055	PROFILE PLANE	SB	A36					BE	100*5.0	2610
7342-F136BS5S	11.6	87519.5	-6236.8	40882.9	PROFILE PLANE	SB	A36					BE	100*5.0	2192
7342-F136BS2S	11	87520.3	-12904.7	40825	PROFILE PLANE	SB	A36					BE	100*5.0	2160
7342-F136BS2S	11	87520.3	-6572.2	40825	PROFILE PLANE	SB	A36					BE	100*5.0	2160
7342-F136BS2S	11	87520.3	-8104.7	40825	PROFILE PLANE	SB	A36					BE	100*5.0	2160
7342-F136BS2S	11	87520.3	-8704.7	40825	PROFILE PLANE	SB	A36					BE	100*5.0	2160
7342-F136BS4S	11.1	87520.3	-6904.7	40832.5	PROFILE PLANE	SB	A36					BE	100*5.0	2175
7342-F136BS4S	11.1	87520.3	-7504.7	40832.5	PROFILE PLANE	SB	A36					BE	100*5.0	2175
7342-F136BS2S	11	87520.3	-9304.7	40825	PROFILE PLANE	SB	A36					BE	100*5.0	2160
7342-F136BS2S	11	87520.3	-9904.7	40825	PROFILE PLANE	SB	A36					BE	100*5.0	2160
7342-F136BS2S	11	87520.3	-11104.7	40825	PROFILE PLANE	SB	A36					BE	100*5.0	2160
7342-F136BS2S	11	87520.3	-11704.7	40825	PROFILE PLANE	SB	A36					BE	100*5.0	2160
7342-F136BS2S	11	87520.3	-12304.7	40825	PROFILE PLANE	SB	A36					BE	100*5.0	2160
7342-314S	10.2	87589	-8334	41945	PROFILE PLANE	SB	A					LAT	50*6.0	4196

7342-312S	7	87589	-12009	41945	PROFILE PLANE	SB	A				LAT	50*6.0	2866
7342-315S	5.3	87589	-13397	40828	PROFILE PLANE	SB	A				LAT	50*6.0	2164
7342-309S	3.6	87520.5	-10275.7	41997.5	PROFILE PLANE	SB	A				LAT	150*15.0	296
7342-310S	3.6	87520.5	-10731.3	41997.5	PROFILE PLANE	SB	A				LAT	150*15.0	296
7342-F136BS9S	2.2	87544	-11402.5	41046	PROFILE PLANE	SB	A				LAT	80*8.0	515
7342-F136BS24S	1.5	87524.4	-10204.3	42150.3	PROFILE PLANE	SB	A36				BE	100*5.0	354
7342-F136BS24S	1.5	87524.4	-6571.8	42150.3	PROFILE PLANE	SB	A36				BE	100*5.0	354
7342-F136BS24S	1.5	87524.4	-7204.3	42150.3	PROFILE PLANE	SB	A36				BE	100*5.0	354
7342-F136BS24S	1.5	87524.4	-7804.3	42150.3	PROFILE PLANE	SB	A36				BE	100*5.0	354
7342-F136BS24S	1.5	87524.4	-8404.3	42150.3	PROFILE PLANE	SB	A36				BE	100*5.0	354
7342-F136BS24S	1.5	87524.4	-9004.3	42150.3	PROFILE PLANE	SB	A36				BE	100*5.0	354
7342-F136BS24S	1.5	87524.4	-9604.3	42150.3	PROFILE PLANE	SB	A36				BE	100*5.0	354
7342-F136BS24S	1.5	87524.4	-13204.3	42150.3	PROFILE PLANE	SB	A36				BE	100*5.0	354
7342-F136BS24S	1.5	87524.4	-12604.3	42150.3	PROFILE PLANE	SB	A36				BE	100*5.0	354
7342-F136BS24S	1.5	87524.4	-12004.3	42150.3	PROFILE PLANE	SB	A36				BE	100*5.0	354
7342-F136BS24S	1.5	87524.4	-11404.3	42150.3	PROFILE PLANE	SB	A36				BE	100*5.0	354
7342-F136BS24S	1.5	87524.4	-10804.3	42150.3	PROFILE PLANE	SB	A36				BE	100*5.0	354
7342-F136BS9S	2.2	87544	-7202.5	41046	PROFILE PLANE	SB	A				LAT	80*8.0	515
7342-F136BS9S	2.2	87544	-12602.5	41046	PROFILE PLANE	SB	A				LAT	80*8.0	515
7342-F136BS9S	2.2	87544	-7802.5	41046	PROFILE PLANE	SB	A				LAT	80*8.0	515
7342-F136BS9S	2.2	87544	-8402.5	41046	PROFILE PLANE	SB	A				LAT	80*8.0	515
7342-F136BS9S	2.2	87544	-9002.5	41046	PROFILE PLANE	SB	A				LAT	80*8.0	515
7342-F136BS9S	2.2	87544	-9602.5	41046	PROFILE PLANE	SB	A				LAT	80*8.0	515
7342-F136BS10S	2.2	87543.9	-10204.2	41046	PROFILE PLANE	SB	A				LAT	80*8.0	518
7342-F136BS11S	2.1	87544.1	-10807.2	41046	PROFILE PLANE	SB	A				LAT	80*8.0	505
7342-F136BS9S	2.2	87544	-12002.5	41046	PROFILE PLANE	SB	A				LAT	80*8.0	515
7342-316S	2.3	87543.6	-13202.5	41046	PROFILE PLANE	SB	A				LAT	80*8.0	515
7342-F136BS23S	1.9	87523.4	-6236.4	42117.3	PROFILE PLANE	SB	A36				BE	100*5.0	418
7342-F136BS8S	0.8	87550.7	-6736.2	41046	PROFILE PLANE	SB	A				LAT	80*8.0	248
7342-F136BS22S	1.1	87526.9	-5104.1	42104.9	PROFILE PLANE	SB	A36				BE	100*5.0	269
7342-F136BS22S	1.1	87526.9	-5704.1	42104.9	PROFILE PLANE	SB	A36				BE	100*5.0	269
7342-F136BS6S	0.8	87550.5	-6402.2	41046	PROFILE PLANE	SB	A				LAT	80*8.0	250
7342-308S	1.1	87622.1	-13391.2	42326.5	PROFILE PLANE	SB	A				LAT	80*8.0	257
7342-308S	1.1	87543.9	-13391.2	42326.5	PROFILE PLANE	SB	A				LAT	80*8.0	257
7342-F136BS16S	0.6	87547.4	-4642.5	41986	PROFILE PLANE	SB	A				LAT	80*8.0	159
7342-L8AP-F140	18	90204	4200	40824.1	PROFILE PLANE	PS	A				LAT	100*10.0	2228
7342-F140AS1S	10.9	90140.4	-3904.7	40825	PROFILE PLANE	SB	A36				BE	100*5.0	2150
7342-F140AS2S	2.2	90164	-3603.5	41049	PROFILE PLANE	SB	A				LAT	80*8.0	513
7342-F140AS2S	2.2	90164	-4202.5	41049	PROFILE PLANE	SB	A				LAT	80*8.0	515
7342-L8BP-F144	18	92764	4200	40824.1	PROFILE PLANE	PS	A				LAT	100*10.0	2228
7342-L8BS-F144	18	92764	-4200	40824.5	PROFILE PLANE	SB	A				LAT	100*10.0	2228

7342-L8BP-F148A	18	95324	4200	40824.1	PROFILE PLANE	PS	A					LAT	100*10.0	2228
7342-L8BS-F148A	18	95324	-4200	40824.1	PROFILE PLANE	SB	A					LAT	100*10.0	2228
7342-F150ASP2P	26.5	96521	2456.1	41057	PROFILE PLANE	PS	A36					BE	140*8.0	2606
7342-F150ASP1S	26.6	96521	-906.1	41055	PROFILE PLANE	SB	A36					BE	140*8.0	2610
7342-F150ASP1S	26.6	96521	-1506.1	41055	PROFILE PLANE	SB	A36					BE	140*8.0	2610
7342-F150ASP1S	26.6	96521	-2106.1	41055	PROFILE PLANE	SB	A36					BE	140*8.0	2610
7342-F150ASP1S	26.6	96521	-3306.1	41055	PROFILE PLANE	SB	A36					BE	140*8.0	2610
7342-F150ASP1S	26.6	96521	-3906.1	41055	PROFILE PLANE	SB	A36					BE	140*8.0	2610
7342-F150ASP1S	26.6	96521	-306.1	41055	PROFILE PLANE	SB	A36					BE	140*8.0	2610
7342-F150ASP1P	26.6	96521	306.1	41055	PROFILE PLANE	PS	A36					BE	140*8.0	2610
7342-F150ASP2P	26.5	96521	906.1	41057	PROFILE PLANE	PS	A36					BE	140*8.0	2606
7342-F150ASP2P	26.5	96521	1506.1	41057	PROFILE PLANE	PS	A36					BE	140*8.0	2606
7342-F150ASP2P	26.5	96521	2106.1	41057	PROFILE PLANE	PS	A36					BE	140*8.0	2606
7342-F150ASP2P	26.5	96521	3306.1	41057	PROFILE PLANE	PS	A36					BE	140*8.0	2606
7342-F150ASP1P	26.6	96521	3906.1	41055	PROFILE PLANE	PS	A36					BE	140*8.0	2610
7342-F150ASP1S	26.6	96521	-2456.1	41055	PROFILE PLANE	SB	A36					BE	140*8.0	2610
7342-F150ASP4S	5.2	96554.3	-2879	41945	PROFILE PLANE	SB	A					LAT	100*10.0	762
7342-F150ASP4P	5.2	96554.3	2879	41945	PROFILE PLANE	PS	A					LAT	100*10.0	762
7342-F150ASP3S	3.2	96556.9	0	41945	PROFILE PLANE	PS	A					LAT	100*10.0	520
7342-F152AP2P	10.9	97831.9	3304.6	41057	PROFILE PLANE	PS	A36					BE	80*5.0	2606
7342-F152AP1P	10.9	97831.9	3904.6	41055	PROFILE PLANE	PS	A36					BE	80*5.0	2610
7342-320P	1.8	97860.2	4225.8	41945	PROFILE PLANE	PS	A36					LAT	40*10.0	554
7342-318P	2	97906.8	4183.3	41945	PROFILE PLANE	PS	A36					LAT	40*10.0	639
7342-L8BS-F152A	32.7	97885	-4250	41055	PROFILE PLANE	SB	A					LAT	150*10.0	2688
7342-319S	0.6	97860.5	-4398.1	41945	PROFILE PLANE	SB	A36					LAT	40*10.0	209
7342-319S	0.6	97909.5	-4398.1	41945	PROFILE PLANE	SB	A36					LAT	40*10.0	209
7342-L8BP-F154A	21.8	99164	4250	41055	PROFILE PLANE	PS	A					LAT	100*10.0	2688
7342-319P	0.6	99140.5	4351.9	40595	PROFILE PLANE	PS	A36					LAT	40*10.0	209
7342-319P	0.6	99187.5	4351.9	40595	PROFILE PLANE	PS	A36					LAT	40*10.0	209
7342-L8BS-F154A	21.8	99164	-4250	41055	PROFILE PLANE	SB	A					LAT	100*10.0	2688
7342-319S	0.6	99140.5	-4351.9	40595	PROFILE PLANE	SB	A36					LAT	40*10.0	209
7342-319S	0.6	99187.5	-4351.9	40595	PROFILE PLANE	SB	A36					LAT	40*10.0	209
7342-L8BP-F156A	32.7	100445	4250	41055	PROFILE PLANE	PS	A					LAT	150*10.0	2688
7342-322P	0.8	100416.1	4401.2	41945	PROFILE PLANE	PS	A36					LAT	50*10.0	209
7342-322P	0.8	100416.1	4348.8	40595	PROFILE PLANE	PS	A36					LAT	50*10.0	209
7342-322P	0.8	100473.9	4348.8	40595	PROFILE PLANE	PS	A36					LAT	50*10.0	209
7342-322P	0.8	100473.9	4401.2	41945	PROFILE PLANE	PS	A36					LAT	50*10.0	209
7342-L8BS-F156A	32.7	100445	-4250	41055	PROFILE PLANE	SB	A					LAT	150*10.0	2688
7342-322S	0.8	100416.1	-4401.2	41945	PROFILE PLANE	SB	A36					LAT	50*10.0	209
7342-322S	0.8	100416.1	-4348.8	40595	PROFILE PLANE	SB	A36					LAT	50*10.0	209
7342-322S	0.8	100473.9	-4348.8	40595	PROFILE PLANE	SB	A36					LAT	50*10.0	209

7342-3225	0.8	100473.9	-4401.2	41945	PROFILE PLANE	SB	A36					LAT	50*10.0	209
7342-F136ASP-L0	18	87430	4	40824.1	PROFILE PLANE	PS	A					LAT	100*10.0	2228
7342-F150ASP-L0	18	96450	4	40824.1	PROFILE PLANE	PS	A					LAT	100*10.0	2228
7342-L1AP3P	13.4	86875.3	240.1	41055	PROFILE PLANE	PS	A36					BE	100*5.0	2610
7342-L1AP2P	2.7	87230	263.2	41049	PROFILE PLANE	PS	A					LAT	80*8.0	620
7342-L1AP1P	0.6	86731	274.4	41049	PROFILE PLANE	PS	A					LAT	80*8.0	208
7342-L1BP3P	13.4	88275.3	240.1	41055	PROFILE PLANE	PS	A36					BE	100*5.0	2610
7342-L1BP1P	2.7	87931	263.2	41049	PROFILE PLANE	PS	A					LAT	80*8.0	608
7342-L1BP2P	0.7	88430	273	41049	PROFILE PLANE	PS	A					LAT	80*8.0	220
7342-L4AS3S	13.4	86875.3	-2040.1	41055	PROFILE PLANE	SB	A36					BE	100*5.0	2610
7342-L4AS2S	2.7	87230	-2063.2	41049	PROFILE PLANE	SB	A					LAT	80*8.0	620
7342-L4AS1S	0.6	86731	-2074.4	41049	PROFILE PLANE	SB	A					LAT	80*8.0	208
7342-L4BS3S	13.4	88275.3	-2040.1	41055	PROFILE PLANE	SB	A36					BE	100*5.0	2610
7342-L4BS1S	2.7	87931	-2063.2	41049	PROFILE PLANE	SB	A					LAT	80*8.0	608
7342-L4BS2S	0.7	88430	-2073	41049	PROFILE PLANE	SB	A					LAT	80*8.0	220
7342-L6AS1S	9.3	85463.8	-3355.8	41915	PROFILE PLANE	SB	A					LAT	100*10.0	1213
7342-L6BS1S	8.3	89583.3	-3355.7	41915	PROFILE PLANE	SB	A					LAT	100*10.0	1093
7342-L8AP1P	133.7	85834	4418.2	41726.7	PROFILE PLANE	PS	A36					BE	140*8.0	11948
7342-L8AP1P	133.7	85834	4418.2	40376.7	PROFILE PLANE	PS	A36					BE	140*8.0	11948
7342-L8AP1P	133.7	85834	4418.2	41051.7	PROFILE PLANE	PS	A36					BE	140*8.0	11948
7342-L8AS1S	53.3	82243	-4418.9	41726.7	PROFILE PLANE	SB	A36					BE	140*8.0	4880
7342-L8AS1S	53.3	82243	-4418.9	40376.7	PROFILE PLANE	SB	A36					BE	140*8.0	4880
7342-L8AS1S	53.3	82243	-4418.9	41051.7	PROFILE PLANE	SB	A36					BE	140*8.0	4880
7342-L8AS2S	29.3	87553.5	-4420.8	41726.9	PROFILE PLANE	SB	A36					BE	140*8.0	2853
7342-L8AS2S	29.3	87553.5	-4420.8	40376.9	PROFILE PLANE	SB	A36					BE	140*8.0	2853
7342-L8AS2S	29.3	87553.5	-4420.8	41051.9	PROFILE PLANE	SB	A36					BE	140*8.0	2853
7342-L8AS5S	20.2	85483.7	-4427.8	41947.5	PROFILE PLANE	SB	A					LAT	150*15.0	1213
7342-L8AS6S	18	89563.6	-4428.2	41947.5	PROFILE PLANE	SB	A					LAT	150*15.0	1093
7342-L8AS3S	16.2	91079.7	-4420.4	41726.9	PROFILE PLANE	SB	A36					BE	140*8.0	1568
7342-L8AS4S	16.1	91083.2	-4420.4	41051.9	PROFILE PLANE	SB	A36					BE	140*8.0	1561
7342-L8AS3S	16.2	91079.7	-4420.4	40376.9	PROFILE PLANE	SB	A36					BE	140*8.0	1568
7342-L8BP5P	53.1	94187.4	4418.2	41726.7	PROFILE PLANE	PS	A36					BE	140*8.0	4748
7342-L8BP5P	53.1	94187.4	4418.2	41051.7	PROFILE PLANE	PS	A36					BE	140*8.0	4748
7342-L8BP3P	51.8	94129	4418.9	40376.7	PROFILE PLANE	PS	A36					BE	140*8.0	4748
7342-L8BP8P	39.8	99281.9	4428	41727.7	PROFILE PLANE	PS	A36					BE	120*6.0	5273
7342-L8BP2P	29.4	99971.9	4428.6	40375.7	PROFILE PLANE	PS	A36					BE	120*6.0	3993
7342-L8BP6P	18.7	97883.5	4428	41052.7	PROFILE PLANE	PS	A36					BE	120*6.0	2473
7342-L8BP1P	7.5	97240	4432.8	40195	PROFILE PLANE	PS	A36					BE	120*6.0	1200
7342-L8BP4P	4.3	96891.3	4436.5	40626	PROFILE PLANE	PS	A36					BE	120*6.0	772
7342-L8BP4P	4.3	97579.3	4436.5	40626	PROFILE PLANE	PS	A36					BE	120*6.0	772
7342-L8BS1S	53.1	94187.4	-4418.2	41726.7	PROFILE PLANE	SB	A36					BE	140*8.0	4748

V. Lista limova_GN7342

Part name	Quantity	Block	Side	Weight	GPS1	GPS2	GPS3	GPS4	Ship	Nested on	Type	Area	Length	Width	Thickness	Functional Desc	Sketches	FCode	Quality
7342-601P	2	GN7342	PS	4.6	F150ASP			7342	394	GN7342_002	BRACKET	0.1	447	200	8	BKT	KG7342_002P.pdf	3111	A36
7342-601S	3	GN7342	SB	4.6	F150ASP			7342	394	GN7342_002	BRACKET	0.1	447	200	8	BKT	KG7342_002P.pdf	3111	A36
7342-602S	2	GN7342	SB	4.6				7342	394	GN7342_301	PLATE	0.1	442	250	8	BKT	PGN7342_301P.pdf	8600	A
7342-603P	1	GN7342	PS	1.3	F154AP			7342	394	GN7342_001	BRACKET	0	240	125	8	BKT	PGN7342_001P.pdf	4321	A36
7342-603S	1	GN7342	SB	1.3	F154AS			7342	394	GN7342_001	BRACKET	0	240	125	8	BKT	PGN7342_001P.pdf	4321	A36
7342-604S	2	GN7342	SB	3.5				7342	394	GN7342_301	PLATE	0.1	490	150	8	BKT	PGN7342_301P.pdf	8600	A
7342-751P	5	GN7342	PS	2.8	X137ASP			7342	394	GN7342_001	CLIP	0	480	108	7	BKT	KG7342_001P.pdf	3111	A
7342-751S	5	GN7342	SB	2.8	X137ASP			7342	394	GN7342_001	CLIP	0	480	108	7	BKT	KG7342_001P.pdf	3111	A
7342-801P	2	GN7342	PS	1.6				7342	394	KSP200	BRACKET	0	200	200	8	SP200	KSP200.pdf	3111	A36
7342-801S	3	GN7342	SB	1.6				7342	394	KSP200	BRACKET	0	200	200	8	SP200	KSP200.pdf	3111	A36
7342-880P	13	GN7342	PS	0.4				7342	394	KPKC100	CLIP	0	122	61.5	8	KPKC100	KPKC100.pdf	3311	A36
7342-880S	16	GN7342	SB	0.4				7342	394	KPKC100	CLIP	0	122	61.5	8	KPKC100	KPKC100.pdf	3311	A36
7342-8814S	1	GN7342	SB	26.6	L8AS			7342	394	KSTD8814	BRACKET	0.1	740	482.4	25	STD-DOOR REINFORCEME	KSTD8814P.pdf	8814	A36
7342-881P	2	GN7342	PS	0.5				7342	394	KPKC120	CLIP	0	142	63	8	KPKC120	KPKC120.pdf	3111	A36
7342-882P	3	GN7342	PS	0.6				7342	394	KPKC140	CLIP	0	162	65	8	KPKC140	KPKC140.pdf	4321	A36
7342-882S	3	GN7342	SB	0.6				7342	394	KPKC140	CLIP	0	162	65	8	KPKC140	KPKC140.pdf	4321	A36
7342-F132AS-1S	1	GN7342	SB	153.9	F132AS			7342	394	GN7342_404	PLATE	2.7	2233	1215.8	7	F-BHD (U12M NS)	PGN7342_404P.pdf	3111	A
7342-F136ASP-1S	1	GN7342	CL	1262	F136ASP			7342	394	GN7342_401	PLATE	22.3	8385.5	2693.6	7	F-BHD (U12M NS)	PGN7342_401P.pdf	3111	A
7342-F136ASP-1P	1	GN7342	CL	21.7	F136ASP			7342	394	GN7342_301	PLATE	0.3	2232.4	150	8	T-BAR U2.3M	PGN7342_301P.pdf	4122	A
7342-F136ASP-1P	1	GN7342	PS	21.7	F136ASP			7342	394	GN7342_301	PLATE	0.3	2232.4	150	8	T-BAR U2.3M	PGN7342_301P.pdf	4122	A
7342-F136ASP-1S	1	GN7342	SB	21.7	F136ASP			7342	394	GN7342_301	PLATE	0.3	2232.4	150	8	T-BAR U2.3M	PGN7342_301P.pdf	4122	A
7342-F136ASP-1S	1	GN7342	PS	918.7	F136BP			7342	394	GN7342_451	PLATE	18.9	7054.9	2698.9	6	F-BHD (U12M PS)	PGN7342_451P.pdf	3311	A
7342-F136BP-2P	1	GN7342	PS	205.4	F136BP			7342	394	GN7342_453	PLATE	2.5	2698.9	1941.3	10	F-BHD (U12M PS)	PGN7342_453P.pdf	3311	A36
7342-F136BS-1S	1	GN7342	SB	918.7	F136BS			7342	394	GN7342_452	PLATE	18.9	7054.9	2698.9	6	F-BHD (U12M PS)	PGN7342_452P.pdf	3311	A
7342-F136BS-2S	1	GN7342	SB	209.9	F136BS			7342	394	GN7342_453	PLATE	2.6	2693.9	1941.3	10	F-BHD (U12M PS)	PGN7342_453P.pdf	3311	A36
7342-F140AS-1S	1	GN7342	SB	153.9	F140AS			7342	394	GN7342_404	PLATE	2.7	2233	1215.8	7	F-BHD (U12M NS)	PGN7342_404P.pdf	3111	A
7342-F150ASP-1S	1	GN7342	CL	1374.9	F150ASP			7342	394	GN7342_402	PLATE	24.2	9005.9	2693.6	7	F-BHD (U12M NS)	PGN7342_402P.pdf	3111	A
7342-F150ASP-1P	1	GN7342	CL	21.7	F150ASP			7342	394	GN7342_301	PLATE	0.3	2232.4	150	8	T-BAR U2.3M	PGN7342_301P.pdf	4122	A
7342-F150ASP-1P	1	GN7342	PS	21.7	F150ASP			7342	394	GN7342_301	PLATE	0.3	2232.4	150	8	T-BAR U2.3M	PGN7342_301P.pdf	4122	A
7342-F150ASP-1S	1	GN7342	SB	21.7	F150ASP			7342	394	GN7342_301	PLATE	0.3	2232.4	150	8	T-BAR U2.3M	PGN7342_301P.pdf	4122	A
7342-F152AP-1P	1	GN7342	PS	230.8	F152AP			7342	394	GN7342_403	PLATE	4.1	2693.6	1516	7	F-BHD (U12M NS)	PGN7342_403P.pdf	3111	A
7342-L1AP-1P	1	GN7342	PS	151.8	L1AP			7342	394	GN7342_403	PLATE	2.7	2693.6	993.7	7	F-BHD (U12M NS)	PGN7342_403P.pdf	3111	A
7342-L1BP-1P	1	GN7342	PS	151.8	L1BP			7342	394	GN7342_403	PLATE	2.7	2693.6	993.7	7	F-BHD (U12M NS)	PGN7342_403P.pdf	3111	A
7342-L4AS-1S	1	GN7342	SB	151.8	L4AS			7342	394	GN7342_403	PLATE	2.7	2693.6	993.7	7	F-BHD (U12M NS)	PGN7342_403P.pdf	3111	A
7342-L4BS-1S	1	GN7342	SB	151.8	L4BS			7342	394	GN7342_403	PLATE	2.7	2693.6	993.7	7	F-BHD (U12M NS)	PGN7342_403P.pdf	3111	A
7342-L6AS-1S	1	GN7342	SB	92.8	L6AS			7342	394	GN7342_402	PLATE	1.6	2691.8	1294.7	7	F-BHD (U12M NS)	PGN7342_402P.pdf	3111	A
7342-L6BS-1S	1	GN7342	SB	74.6	L6BS			7342	394	GN7342_402	PLATE	1.3	2691.8	1174.6	7	F-BHD (U12M NS)	PGN7342_402P.pdf	3111	A
7342-L8AP-1P	1	GN7342	PS	2607.3	L8AP			7342	394	GN7342_501	PLATE	32.2	11960.2	2691.4	10	F-SHELL (U12M WS)	PGN7342_501P.pdf	2212	A36
7342-L8AP-F128AP-1P	1	GN7342	PS	41.5	L8AP			7342	394	GN7342_301	PLATE	0.6	2232.2	300	8	T-BAR U2.3M	PGN7342_301P.pdf	4122	A
7342-L8AP-F132AP-1P	1	GN7342	PS	41.5	L8AP			7342	394	GN7342_301	PLATE	0.6	2232.2	300	8	T-BAR U2.3M	PGN7342_301P.pdf	4122	A
7342-L8AP-F136AP-1P	1	GN7342	PS	50.9	L8AP			7342	394	GN7342_301	PLATE	0.8	2692.6	300	8	T-BAR O2.3M	PGN7342_301P.pdf	4321	A
7342-L8AP-F140AP-1P	1	GN7342	PS	41.5	L8AP			7342	394	GN7342_301	PLATE	0.6	2232.2	300	8	T-BAR U2.3M	PGN7342_301P.pdf	4122	A
7342-L8AS-101S	1	GN7342	SB	30.5	L8AS			7342	394	GN7342_002	PLATE	0.2	512.3	397.4	20	F-SHELL (U12M WS)	PGN7342_002P.pdf	2212	A36
7342-L8AS-1S	1	GN7342	SB	2272.7	L8AS			7342	394	GN7342_504	PLATE	28.1	11960.2	2691.4	10	F-SHELL (U12M WS)	PGN7342_504P.pdf	2212	A36
7342-L8AS-F128AS-1S	1	GN7342	SB	41.5	L8AS			7342	394	GN7342_301	PLATE	0.6	2232.2	300	8	T-BAR U2.3M	PGN7342_301P.pdf	4122	A
7342-L8AS-F136AS-1S	1	GN7342	SB	50.9	L8AS			7342	394	GN7342_301	PLATE	0.8	2692.6	300	8	T-BAR O2.3M	PGN7342_301P.pdf	4321	A
7342-L8BP-1P	1	GN7342	PS	2173.6	L8BP			7342	394	GN7342_502	PLATE	26.8	10118.3	2690	10	F-SHELL (U12M WS)	PGN7342_502P.pdf	2212	A36
7342-L8BP-F144AP-1P	1	GN7342	PS	41.5	L8BP			7342	394	GN7342_301	PLATE	0.6	2232.2	300	8	T-BAR U2.3M	PGN7342_301P.pdf	4122	A
7342-L8BP-F148AP-1P	1	GN7342	PS	41.5	L8BP			7342	394	GN7342_301	PLATE	0.6	2232.2	300	8	T-BAR U2.3M	PGN7342_301P.pdf	4122	A
7342-L8BP-F154AP-1P	1	GN7342	PS	42.6	L8BP			7342	394	GN7342_301	PLATE	0.7	2692.6	250	8	T-BAR O2.3M	PGN7342_301P.pdf	4321	A

7342-L8BP-F156AP-1P	1	GN7342	PS		53.2	L8BP	F156AP		7342	394	PGN7342_453	PLATE	0.7	2692.2	250	10	T-BAR O2.3M	PGN7342_453P.pdf	4321	A
7342-L8BS-1S	1	GN7342	SB		2205.8	L8BS	L8BS		7342	394	PGN7342_503	PLATE	27.2	10118.3	2691.4	10	F-SHELL (U12M WS)	PGN7342_503P.pdf	2212	A36
7342-L8BS-F144AS-1S	1	GN7342	SB		41.5	L8BS	F144AS		7342	394	PGN7342_301	PLATE	0.6	2232.2	300	8	T-BAR U2.3M	PGN7342_301P.pdf	4122	A
7342-L8BS-F148AS-1S	1	GN7342	SB		41.5	L8BS	F148AS		7342	394	PGN7342_301	PLATE	0.6	2232.2	300	8	T-BAR U2.3M	PGN7342_301P.pdf	4122	A
7342-L8BS-F152AS-1S	1	GN7342	SB		52.6	L8BS	F152AS		7342	394	PGN7342_453	PLATE	0.6	2692.2	250	10	T-BAR O2.3M	PGN7342_453P.pdf	4321	A
7342-L8BS-F154AS-1S	1	GN7342	SB		42.6	L8BS	F154AS		7342	394	PGN7342_301	PLATE	0.7	2692.6	250	8	T-BAR O2.3M	PGN7342_301P.pdf	4321	A
7342-L8BS-F156AS-1S	1	GN7342	SB		53.2	L8BS	F156AS		7342	394	PGN7342_453	PLATE	0.7	2692.2	250	10	T-BAR O2.3M	PGN7342_453P.pdf	4321	A
7342-X133AS-1S	1	GN7342	SB		189.5		X133AS		7342	394	PGN7342_403	PLATE	3.3	2693.6	1240.8	7	F-BHD (U12M NS)	PGN7342_403P.pdf	3111	A
7342-X135ASP-1S	1	GN7342	SB		263.5		X135ASP		7342	394	PGN7342_401	PLATE	4.6	2693.6	2445.6	7	F-BHD (U12M NS)	PGN7342_401P.pdf	3111	A
7342-X137ASP-1S	1	GN7342	SB		263.5		X137ASP		7342	394	PGN7342_403	PLATE	4.6	2693.6	2445.6	7	F-BHD (U12M NS)	PGN7342_403P.pdf	3111	A
7342-X138AS-1S	1	GN7342	SB		189.5		X138AS		7342	394	PGN7342_403	PLATE	3.3	2693.6	1240.8	7	F-BHD (U12M NS)	PGN7342_403P.pdf	3111	A
7342-Y6AP-1P	1	GN7342	PS		194.3		Y6AP		7342	394	PGN7342_403	PLATE	3.4	2689.6	1273.8	7	F-BHD (U12M NS)	PGN7342_403P.pdf	3111	A

VI. Lista profila _GN7342

Part name	Quantity	Ship	Block	Side	Weight	Quality	GPS1	GPS2	GPS3	GPS4	Type	Shape	Dim	Length	Direction	Left Endcut	Snipe	Bevel Web	Right Endcut	Bevel Web	Sketch	Functional Assembly	Pos no	Sketches	FCode
7342-301P	1	394	GN7342	PS	5.7 A						7342 PROFILE	LAT	150x15.0	410	410 CL	1302		0	1100	VP23	07342-301P	F-BHD (U12M PS)	301		3311
7342-302P	1	394	GN7342	PS	3.6 A						7342 PROFILE	LAT	150x15.0	297	297 CL	1100		VP23	0	2100	07342-302P	F-BHD (U12M PS)	302		3311
7342-303P	1	394	GN7342	PS	17.2 A						7342 PROFILE	L	40x40x4.0x4.0	6977	6977 CL	2100		0	1100	07342-303P	F-BHD (U12M PS)	303		3311	
7342-304P	1	394	GN7342	PS	6.9 A						7342 PROFILE	LAT	50x6.0	2860	2860 CL	1100		0	1100	07342-304P	F-BHD (U12M PS)	304		3311	
7342-305P	1	394	GN7342	PS	10.3 A						7342 PROFILE	LAT	50x6.0	4236	4236 OUT	1100		0	1100	07342-305P	F-BHD (U12M PS)	305		3311	
7342-306P	1	394	GN7342	PS	5.3 A						7342 PROFILE	LAT	50x6.0	2167	2167 DOWN	1100		0	1302	07342-306P	F-BHD (U12M PS)	306		3311	
7342-307P	1	394	GN7342	PS	2.3 A						7342 PROFILE	LAT	80x8.0	515	515 OUT	1302		0	1190	07342-307P	F-BHD (U12M PS)	307		3311	
7342-308P	2	394	GN7342	SB	1.1 A						7342 PROFILE	LAT	80x8.0	257	257 OUT	1302		0	1190	07342-308P	F-BHD	308		3311	
7342-309S	1	394	GN7342	SB	1.1 A						7342 PROFILE	LAT	80x8.0	257	257 OUT	1302		0	1190	07342-309S	F-BHD	309		3311	
7342-310S	1	394	GN7342	SB	3.6 A						7342 PROFILE	LAT	150x15.0	297	297 OUT	1100		8	0	1100	07342-310S	F-BHD (U12M PS)	310		3311
7342-311S	1	394	GN7342	SB	3.6 A						7342 PROFILE	LAT	150x15.0	297	297 OUT	1100		8	0	1100	07342-311S	F-BHD (U12M PS)	311		3311
7342-312S	1	394	GN7342	SB	7 A						7342 PROFILE	LAT	50x6.0	6977	6977 OUT	2100		0	2100	07342-312S	F-BHD (U12M PS)	312		3311	
7342-314S	1	394	GN7342	SB	10.2 A						7342 PROFILE	LAT	50x6.0	4199	4199 OUT	1100		0	1100	07342-314S	F-BHD (U12M PS)	314		3311	
7342-315S	1	394	GN7342	SB	5.3 A						7342 PROFILE	LAT	50x6.0	2167	2167 DOWN	1100		0	1100	07342-315S	F-BHD (U12M PS)	315		3311	
7342-316P	1	394	GN7342	SB	2.3 A						7342 PROFILE	LAT	80x8.0	515	515 CL	1302		0	1302	07342-316P	F-BHD (U12M PS)	316		3311	
7342-318P	1	394	GN7342	PS	2 A						7342 PROFILE	LAT	40x10.0	639	639 OUT	1302		0	1190	07342-318P	F-BHD (U12M NS)	318		4321	
7342-319P	4	394	GN7342	SB	0.6 A						7342 PROFILE	LAT	40x10.0	209	209 OUT	1190		8	0	1302	07342-319P	T-BAR	319		4321
7342-320P	1	394	GN7342	PS	0.6 A						7342 PROFILE	LAT	40x10.0	209	209 CL	1302		0	1302	07342-320P	F-BHD (U12M NS)	320		3111	
7342-321P	1	394	GN7342	PS	1.8 A						7342 PROFILE	LAT	40x10.0	554	554 CL	1190		8	0	1302	07342-321P	F-BHD (U12M NS)	321		4321
7342-322P	4	394	GN7342	PS	0.8 A						7342 PROFILE	LAT	50x10.0	209	209 CL	1302		0	1190	07342-322P	T-BAR	322		4321	
7342-322S	4	394	GN7342	SB	0.8 A						7342 PROFILE	LAT	50x10.0	209	209 OUT	1190		8	0	1302	07342-322S	T-BAR	322		4321
7342-323S	1	394	GN7342	SB	10.9 A						7342 PROFILE	BE	100x5.0	2153	2153 UP	2302		0	2302	07342-F132AS1S	F-BHD (U12M NS)	1		3111	
7342-F132AS1S	1	394	GN7342	SB	2.1 A						7342 PROFILE	LAT	80x8.0	535	535 CL	1100		0	1100	07342-F132AS2S	F-BHD (U12M NS)	2		3111	
7342-F132AS2S	1	394	GN7342	SB	2.2 A						7342 PROFILE	LAT	80x8.0	515	515 CL	1302		0	1302	07342-F132AS3S	F-BHD (U12M NS)	3		3111	
7342-F132AS3S	1	394	GN7342	SB	18 A						7342 PROFILE	LAT	100x10.0	2230	2230 UP	1100		0	1402	07342-F136ASP-LOAP1S	T-BAR U2.3M	1		4122	
7342-F136ASP-LOAP1S	1	394	GN7342	PS	18 A						7342 PROFILE	LAT	100x10.0	2230	2230 UP	1100		0	1402	07342-F136ASP-LOAP1S	T-BAR U2.3M	1		4122	
7342-F136ASP-Y5AP1P	1	394	GN7342	PS	18 A						7342 PROFILE	LAT	100x10.0	2230	2230 UP	1100		0	1402	07342-F136ASP-Y5AP1P	T-BAR U2.3M	1		4122	
7342-F136ASP-Y5AS1S	3	394	GN7342	SB	25.5 A						7342 PROFILE	BE	140x8.0	2513	2513 DOWN	2302		0	2302	07342-F136ASP-Y5AS1S	F-BHD	1		3111	
7342-F136ASP-Y5AS1S	1	394	GN7342	SB	26.6 A						7342 PROFILE	BE	140x8.0	2613	2614 UP	2302		0	2302	07342-F136ASP-Y5AS1S	F-BHD	2		3111	
7342-F136ASP-Y5AS1S	3	394	GN7342	SB	26.6 A						7342 PROFILE	BE	140x8.0	2613	2614 DOWN	2302		0	2302	07342-F136ASP-Y5AS1S	F-BHD	2		3111	
7342-F136ASP-Y5AS1S	5	394	GN7342	PS	26.5 A						7342 PROFILE	BE	140x8.0	2609	2609 UP	2302		0	2302	07342-F136ASP-Y5AS1S	F-BHD	3		3111	
7342-F136ASP-Y5AS1S	1	394	GN7342	PS	0.6 A						7342 PROFILE	LAT	80x8.0	159	159 CL	1392		8	0	1302	07342-F136BP12P	F-BHD (U12M PS)	12		3311
7342-F136BP12P	1	394	GN7342	PS	14.4 A						7342 PROFILE	LAT	120x10.0	1519	1519 CL	1392		8	0	1392	07342-F136BP12P	F-BHD (U12M PS)	13		3311
7342-F136BP12P	1	394	GN7342	PS	68.8 A						7342 PROFILE	LAT	150x15.0	382	382 CL	1100		VP23	0	1392	07342-F136BP12P	F-BHD (U12M PS)	14		3311
7342-F136BP12P	1	394	GN7342	PS	43 A						7342 PROFILE	LAT	150x15.0	2458	2458 CL	1302		0	1100	VP23	07342-F136BP12P	F-BHD (U12M PS)	17		3311
7342-F136BP12P	2	394	GN7342	PS	1 A						7342 PROFILE	BE	100x5.0	269	269 UP	2392		8	0	2302	07342-F136BP18P	F-BHD	18		3311
7342-F136BP18P	1	394	GN7342	PS	0.9 A						7342 PROFILE	BE	100x5.0	264	264 UP	2392		8	0	2302	07342-F136BP18P	F-BHD	19		3311
7342-F136BP18P	1	394	GN7342	PS	37.4 A						7342 PROFILE	T	100x100x11.0x11.0	2237	2237 UP	3102		0	3102	07342-F136BP18P	F-BHD (U12M PS)	1		7342-F136BP18P-Q.pdf	
7342-F136BP18P	12	394	GN7342	PS	1.9 A						7342 PROFILE	BE	100x5.0	419	419 UP	2100		VP23	0	2302	07342-F136BP20P	F-BHD (U12M PS)	20		3311
7342-F136BP20P	11	394	GN7342	PS	11 A						7342 PROFILE	BE	100x5.0	355	355 UP	2190		8	0	2302	07342-F136BP20P	F-BHD	21		3311
7342-F136BP20P	1	394	GN7342	PS	11.6 A						7342 PROFILE	BE	100x5.0	2163	2163 UP	2302		0	2302	07342-F136BP20P	F-BHD	2		3311	
7342-F136BP20P	2	394	GN7342	PS	0.9 A						7342 PROFILE	LAT	80x8.0	248	248 OUT	1302		0	1302	07342-F136BP20P	F-BHD	5		3311	
7342-F136BP20P	9	394	GN7342	PS	2.3 A						7342 PROFILE	LAT	80x8.0	515	515 OUT	1302		0	1302	07342-F136BP20P	F-BHD	6		3311	
7342-F136BP20P	1	394	GN7342	PS	13.4 A						7342 PROFILE	LAT	80x8.0	509	509 OUT	1302		0	1302	07342-F136BP20P	F-BHD (U12M PS)	8		3311	
7342-F136BP20P	1	394	GN7342	PS	2.2 A						7342 PROFILE	BE	100x5.0	2614	2614 UP	2302		0	2302	07342-F136BP20P	F-BHD (U12M PS)	9		3311	
7342-F136BP20P	1	394	GN7342	PS	2.2 A						7342 PROFILE	LAT	80x8.0	519	519 CL	1302		0	1302	07342-F136BP20P	F-BHD (U12M PS)	10		3311	
7342-F136BP20P	1	394	GN7342	SB	2.1 A						7342 PROFILE	LAT	80x8.0	506	506 CL	1302		0	1302	07342-F136BP20P	F-BHD (U12M PS)	11		3311	
7342-F136BP20P	1	394	GN7342	SB	13.4 A						7342 PROFILE	BE	100x5.0	2614	2614 DOWN	2302		0	2302	07342-F136BP20P	F-BHD (U12M PS)	13		3311	
7342-F136BP20P	1	394	GN7342	SB	0.6 A						7342 PROFILE	LAT	120x10.0	1519	1519 CL	1392		8	0	1392	07342-F136BP20P	F-BHD (U12M PS)	16		3311
7342-F136BP20P	1	394	GN7342	SB	14.4 A						7342 PROFILE	LAT	120x10.0	1516	1516 OUT	1392		8	0	1392	07342-F136BP20P	F-BHD (U12M PS)	17		3311
7342-F136BP20P	1	394	GN7342	SB	71 A						7342 PROFILE	LAT	150x15.0	3928	3928 OUT	1392		8	0	1100	07342-F136BP20P	F-BHD (U12M PS)	18		3311
7342-F136BP20P	1	394	GN7342	SB	37.4 A						7342 PROFILE	T	100x100x11.0x11.0	2237	2237 DOWN	3102		0	3102	07342-F136BP20P	F-BHD (U12M PS)	1		7342-F136BP20P-Q.pdf	
7342-F136BP20P	2	394																							

7342-F150ASFP1	7	394	GN7342	SB	26.6	A36	F150ASP	7342	PROFILE	BE	140x8.0	2613	2614	DOWN	2302	0	2302	0	7342-F150ASFP1	F-BHD	3111	
7342-F150ASFP2	5	394	GN7342	PS	26.5	A36	F150ASP	7342	PROFILE	BE	140x8.0	2609	2609	UP	2302	0	2302	0	7342-F150ASFP2	F-BHD	3111	
7342-F150ASFP3	1	394	GN7342	SB	3.2	A	F150ASP	7342	PROFILE	LAT	100x10.0	520	520	SB	1302	0	1302	0	7342-F150ASFP3	F-BHD (U12M NS)	3111	
7342-F150ASP4P	1	394	GN7342	PS	5.2	A	F150ASP	7342	PROFILE	LAT	100x10.0	763	763	CL	1302	0	1302	0	7342-F150ASP4P	F-BHD (U12M NS)	3111	
7342-F150ASP4S	1	394	GN7342	SB	5.2	A	F150ASP	7342	PROFILE	LAT	100x10.0	763	763	OUT	1302	0	1302	0	7342-F150ASP4S	F-BHD (U12M NS)	3111	
7342-F152AP1P	1	394	GN7342	PS	10.9	A36	F152AP	7342	PROFILE	BE	80x5.0	2613	2614	UP	2302	0	2302	0	7342-F152AP1P	F-BHD (U12M NS)	3111	
7342-F152AP2P	1	394	GN7342	PS	10.9	A36	F152AP	7342	PROFILE	BE	80x5.0	2609	2609	UP	2302	0	2302	0	7342-F152AP2P	F-BHD (U12M NS)	3111	
7342-L1AP1P	1	394	GN7342	PS	0.6	A	L1AP	7342	PROFILE	LAT	80x8.0	208	208	FOR	1302	0	1302	0	7342-L1AP1P	F-BHD (U12M NS)	3111	
7342-L1AP2P	1	394	GN7342	PS	2.7	A	L1AP	7342	PROFILE	LAT	80x8.0	620	620	FOR	1302	0	1302	0	7342-L1AP2P	F-BHD (U12M NS)	3111	
7342-L1AP3P	1	394	GN7342	PS	13.4	A36	L1AP	7342	PROFILE	BE	100x5.0	2613	2614	UP	2302	0	2302	0	7342-L1AP3P	F-BHD (U12M NS)	3111	
7342-L1BP1P	1	394	GN7342	PS	2.7	A	L1BP	7342	PROFILE	LAT	80x8.0	608	608	FOR	1302	0	1302	0	7342-L1BP1P	F-BHD (U12M NS)	3111	
7342-L1BP2P	1	394	GN7342	PS	0.7	A	L1BP	7342	PROFILE	LAT	80x8.0	220	220	FOR	1302	0	1302	0	7342-L1BP2P	F-BHD (U12M NS)	3111	
7342-L1BP3P	1	394	GN7342	PS	13.4	A36	L1BP	7342	PROFILE	BE	100x5.0	2613	2614	UP	2302	0	2302	0	7342-L1BP3P	F-BHD (U12M NS)	3111	
7342-L4AS1S	1	394	GN7342	SB	0.6	A	L4AS	7342	PROFILE	LAT	80x8.0	208	208	AFT	1302	0	1302	0	7342-L4AS1S	F-BHD (U12M NS)	3111	
7342-L4AS2S	1	394	GN7342	SB	2.7	A	L4AS	7342	PROFILE	LAT	80x8.0	620	620	AFT	1302	0	1302	0	7342-L4AS2S	F-BHD (U12M NS)	3111	
7342-L4AS3S	1	394	GN7342	SB	13.4	A36	L4AS	7342	PROFILE	BE	100x5.0	2613	2614	DOWN	2302	0	2302	0	7342-L4AS3S	F-BHD (U12M NS)	3111	
7342-L4BS1S	1	394	GN7342	SB	2.7	A	L4BS	7342	PROFILE	LAT	80x8.0	608	608	AFT	1302	0	1302	0	7342-L4BS1S	F-BHD (U12M NS)	3111	
7342-L4BS2S	1	394	GN7342	SB	0.7	A	L4BS	7342	PROFILE	LAT	80x8.0	220	220	AFT	1302	0	1302	0	7342-L4BS2S	F-BHD (U12M NS)	3111	
7342-L4BS3S	1	394	GN7342	SB	13.4	A36	L4BS	7342	PROFILE	BE	100x5.0	2613	2614	DOWN	2302	0	2302	0	7342-L4BS3S	F-BHD (U12M NS)	3111	
7342-L6AS1S	1	394	GN7342	SB	9.3	A	L6AS	7342	PROFILE	LAT	100x10.0	1215	1215	FOR	1302	0	1302	0	7342-L6AS1S	F-BHD (U12M NS)	3111	
7342-L6AS2S	1	394	GN7342	SB	8.3	A	L6AS	7342	PROFILE	LAT	100x10.0	1094	1094	FOR	1302	0	1302	0	7342-L6AS2S	F-BHD (U12M NS)	3111	
7342-L8AP-F128AP1P	1	394	GN7342	PS	18	A	L8AP	F128AP	7342	PROFILE	LAT	100x10.0	2230	2230	UP	1402	0	1402	0	7342-L8AP-F128AP1P	T-BAR U2.3M	4122
7342-L8AP-F132AP1P	1	394	GN7342	PS	18	A	L8AP	F132AP	7342	PROFILE	LAT	100x10.0	2230	2230	UP	1402	0	1402	0	7342-L8AP-F132AP1P	T-BAR U2.3M	4122
7342-L8AP-F136AP1P	1	394	GN7342	PS	21.8	A	L8AP	F136AP	7342	PROFILE	LAT	100x10.0	2691	2691	UP	1100	0	1100	0	7342-L8AP-F136AP1P	T-BAR O2.3M	4321
7342-L8AP-F140AP1P	1	394	GN7342	PS	18	A	L8AP	F140AP	7342	PROFILE	LAT	100x10.0	2230	2230	UP	1100	0	1100	0	7342-L8AP-F140AP1P	T-BAR O2.3M	4122
7342-L8AP-F144AP1P	3	394	GN7342	PS	133.7	A36	L8AP	F144AP	7342	PROFILE	BE	140x8.0	11960	11960	AFT	2180	0	2180	0	7342-L8AP-F144AP1P	F-SHELL	4122
7342-L8AS-F128AS1S	1	394	GN7342	SB	18	A	L8AS	F128AS	7342	PROFILE	LAT	100x10.0	2691	2691	DOWN	1100	0	1100	0	7342-L8AS-F128AS1S	T-BAR U2.3M	4321
7342-L8AS-F136AS1S	1	394	GN7342	SB	21.8	A	L8AS	F136AS	7342	PROFILE	LAT	100x10.0	2691	2691	DOWN	1100	0	1100	0	7342-L8AS-F136AS1S	T-BAR O2.3M	4321
7342-L8AS1S	3	394	GN7342	SB	53.3	A36	L8AS	7342	PROFILE	BE	140x8.0	4885	4885	FOR	2180	0	2302	0	7342-L8AS1S	F-SHELL	2212	
7342-L8AS2S	3	394	GN7342	SB	29.3	A36	L8AS	7342	PROFILE	BE	140x8.0	2856	2856	FOR	2302	0	2302	0	7342-L8AS2S	F-SHELL	2212	
7342-L8AS3S	2	394	GN7342	SB	16.2	A36	L8AS	7342	PROFILE	BE	140x8.0	1570	1570	FOR	2302	0	2180	VA23	7342-L8AS3S	F-SHELL	2212	
7342-L8AS4S	1	394	GN7342	SB	16.1	A36	L8AS	7342	PROFILE	BE	140x8.0	1563	1563	FOR	2302	0	2180	VA23	7342-L8AS4S	F-SHELL (U12M WS)	2212	
7342-L8AS5S	1	394	GN7342	SB	20.2	A	L8AS	7342	PROFILE	LAT	150x15.0	1214	1214	AFT	1100	0	1302	0	7342-L8AS5S	F-SHELL (U12M WS)	2212	
7342-L8AS6S	1	394	GN7342	SB	18	A	L8AS	7342	PROFILE	LAT	150x15.0	1094	1094	AFT	1302	0	1100	0	7342-L8AS6S	F-SHELL (U12M WS)	2212	
7342-L8BP-F144BP1P	1	394	GN7342	PS	18	A	L8BP	F144BP	7342	PROFILE	LAT	100x10.0	2230	2230	UP	1100	0	1402	0	7342-L8BP-F144BP1P	T-BAR U2.3M	4122
7342-L8BP-F148BP1P	1	394	GN7342	PS	18	A	L8BP	F148BP	7342	PROFILE	LAT	100x10.0	2230	2230	UP	1100	0	1402	0	7342-L8BP-F148BP1P	T-BAR U2.3M	4122
7342-L8BP-F154BP1P	1	394	GN7342	PS	21.8	A	L8BP	F154BP	7342	PROFILE	LAT	100x10.0	2691	2691	UP	1100	0	1100	0	7342-L8BP-F154BP1P	T-BAR O2.3M	4321
7342-L8BP-F156BP1P	1	394	GN7342	PS	32.7	A	L8BP	F156BP	7342	PROFILE	LAT	150x10.0	2690	2690	UP	1100	0	1100	0	7342-L8BP-F156BP1P	T-BAR O2.3M	4321
7342-L8BP1P	1	394	GN7342	PS	7.5	A36	L8BP	7342	PROFILE	BE	120x6.0	1201	1201	AFT	2302	0	2302	0	7342-L8BP1P	F-SHELL (U12M WS)	2212	
7342-L8BP2P	1	394	GN7342	PS	29.4	A36	L8BP	7342	PROFILE	BE	120x6.0	3997	3997	AFT	2180	0	2302	0	7342-L8BP2P	F-SHELL (U12M WS)	2212	
7342-L8BP3P	1	394	GN7342	PS	51.8	A36	L8BP	7342	PROFILE	BE	140x8.0	4753	4753	AFT	2302	0	2180	VA23	7342-L8BP3P	F-SHELL (U12M WS)	2212	
7342-L8BP4P	2	394	GN7342	PS	4.3	A36	L8BP	7342	PROFILE	BE	120x6.0	772	772	UP	2302	0	2302	0	7342-L8BP4P	F-SHELL	2212	
7342-L8BP5P	2	394	GN7342	PS	53.1	A36	L8BP	7342	PROFILE	BE	140x8.0	4753	4753	AFT	2100	0	2180	VA23	7342-L8BP5P	F-SHELL	2212	
7342-L8BP6P	1	394	GN7342	PS	18.7	A36	L8BP	7342	PROFILE	BE	120x6.0	2476	2476	AFT	2100	0	2100	0	7342-L8BP6P	F-SHELL (U12M WS)	2212	
7342-L8BP8P	1	394	GN7342	PS	39.8	A36	L8BP	7342	PROFILE	BE	120x6.0	5278	5278	AFT	2180	0	2100	0	7342-L8BP8P	F-SHELL (U12M WS)	2212	
7342-L8BS-F144BS1S	1	394	GN7342	SB	18	A	L8BS	F144BS	7342	PROFILE	LAT	100x10.0	2230	2230	DOWN	1402	0	1100	0	7342-L8BS-F144BS1S	T-BAR U2.3M	4122
7342-L8BS-F148BS1S	1	394	GN7342	SB	18	A	L8BS	F148BS	7342	PROFILE	LAT	100x10.0	2230	2230	DOWN	1402	0	1100	0	7342-L8BS-F148BS1S	T-BAR U2.3M	4122
7342-L8BS-F152AS1S	1	394	GN7342	SB	32.7	A	L8BS	F152AS	7342	PROFILE	LAT	150x10.0	2690	2690	DOWN	1100	0	1100	0	7342-L8BS-F152AS1S	T-BAR O2.3M	4321
7342-L8BS-F154AS1S	1	394	GN7342	SB	21.8	A	L8BS	F154AS	7342	PROFILE	LAT	100x10.0	2691	2691	DOWN	1100	0	1100	0	7342-L8BS-F154AS1S	T-BAR O2.3M	4321
7342-L8BS-F156AS1S	1	394	GN7342	SB	32.7	A	L8BS	F156AS	7342	PROFILE	LAT	150x10.0	2690	2690	DOWN	1100	0	1100	0	7342-L8BS-F156AS1S	T-BAR O2.3M	4321
7342-L8BS1S	2	394	GN7342	SB	53.1	A36	L8BS	7342	PROFILE	BE	140x8.0	4753	4753	FOR	2180	0	2100	0	7342-L8BS1S	F-SHELL	2212	
7342-L8BS2S	2	394	GN7342	SB	39.8	A36	L8BS	7342	PROFILE	BE	120x6.0	5278	5278	FOR	2100	0	2180	VP23	7342-L8BS2S	F-SHELL	2212	
7342-L8BS3S	1	394	GN7342	SB	53.1	A36	L8BS	7342	PROFILE	BE	140x8.0	4753	4753	FOR	2180	0	2100	0	7342-L8BS3S	F-SHELL (U12M WS)	2212	
7342-L8BS4S	1	394	GN7342	SB	18.7	A36	L8BS	7342	PROFILE	BE	120x6.0	2476	2476	FOR	2100	0	2100	0	7342-L8BS4S	F-SHELL (U12M WS)	2212	
7342-L133AS1S	1	394	GN7342	SB	2.2	A	L133AS	7342	PROFILE	LAT	80x8.0	513	513	OUT	1302	0	1302	0	7342-L133AS1S	F-BHD (U12M NS)	3111	
7342-L133AS2S	1	394	GN7342	SB	2.3	A	L133AS	7342	PROFILE	LAT	80x8.0	540	540	OUT	1302	0	1302	0	7342-L133AS2S	F-BHD (U12M NS)	3111	
7342-L133AS3S	1	394	GN7342	SB	13.4	A36	L133AS	7342	PROFILE	BE	100x5.0	2613	2614	DOWN	2302	0	2302	0	7342-L133AS3S	F-BHD (U12M NS)	3111	
7342-L135ASP1S	1	394	GN7342	SB	2.6	A	L135ASP	7342	PROFILE	LAT	80x8.0	595	595	OUT	1302	0	1302	0	7342-L135ASP1S	F-BHD (U12M NS)	3111	
7342-L135ASP2S	1	394	GN7342	SB	2.3	A	L135ASP	7342	PROFILE	LAT	80x8.0	537	537	OUT	1302	0	1302	0	7342-L135ASP2S	F-BHD (U12M NS)	3111	
7342-L135ASP3S	2	394	GN7342	SB	13.4	A36	L135ASP	7342	PROFILE	BE	100x5.0	2613	2614	DOWN	2302	0	2302	0	7342-L135ASP3S	F-BHD (U12M NS)	3111	
7342-L135ASP4P	1	394	GN7342	PS	1.3	A	L135ASP	7342	PROFILE	LAT	100x10.0	223	223	CL	1302	0	1100	VP22	7342-L135ASP4P	F-BHD (U12M NS)	3111	
7342-L135ASP5P	1	394	GN7342	PS	6.1	A	L135ASP	7342	PROFILE	LAT	100x10.0	771	771	OUT	1100	0	1392	0	7342-L135ASP5P	F-BHD (U12M NS)	3111	
7342-L135ASP6S	1	394	GN7342	SB	3	A	L1															

7342-X13BAS35	1	394	GN7342	SB	13.4 / A36	X13BAS	7342 PROFILE	BE	100x5.0	2613	2614 UP	2302	0	2302	07342-X13BAS35	F-BHD (U12M NS)	3	3111
7342-Y6AP1P	2	394	GN7342	PS	12.5 / A36	Y6AP	7342 PROFILE	BE	80x6.0	2609	2609 UP	2302	0	2302	07342-Y6AP1P	F-BHD	1	3111

VII. Profile sketch_ GN7342

T	Laiva Ship	Profiili luonnoksen nimi Name of prof. sketch drawing			Pvm/Tekijä Date/ Design	
	394	7342-F136BP1P-Q			07-03-2018 / MAS	
Osan nimi Part name		Esitetty Shown	Lkm Pcs.	Tyyppi Shape	Profiilin mitat Prof. dimensions	
7342-F136BP1P		PS	P C S 1 0 0	T	100*100*11.0*11.0	
			Laatu Quality		Max.pituus Tot.length	
			A		2237	

Q16

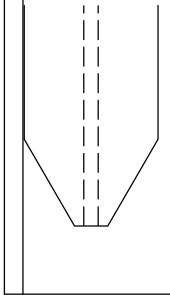

Q3

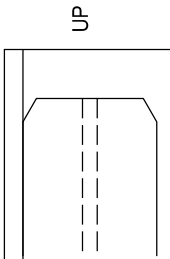

FORE

0

2237

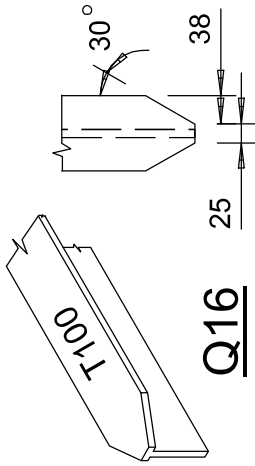

Q16

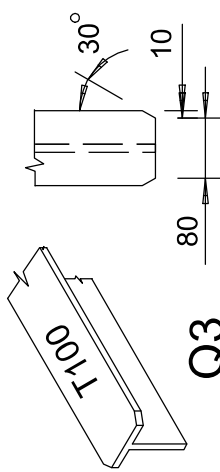

Q3

END	TYPE	A	B	C	R1	R2	V1	V2	V3	V4	KS	Excess	GAP	Bev	Web	TS	Bev	Face	OS	Nose	F	Endcut
LEFT	31			25	0		90	30	30	90				V		°	V		°			3102
RIGHT	31			80	0		90	30	30	90				V		°	V		°			3102

T	Laiva Ship	Profiili luonnoksen nimi Name of prof. sketch drawing		Pvm/Tekijä Date/ Design			
	394	7342-F136BS1S-Q	07-03-2018	/ MAS			
Osan nimi Part name	7342-F136BS1S	Esitetty Shown	SB	Lkm Pcs.	Tyypin muoto Shape	Laatu Quality	Max.pituus Tot.length
				0	T		
				100*100*11.0*11.0			

Q3

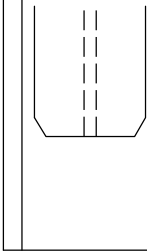

End 1

DOWN

FORE

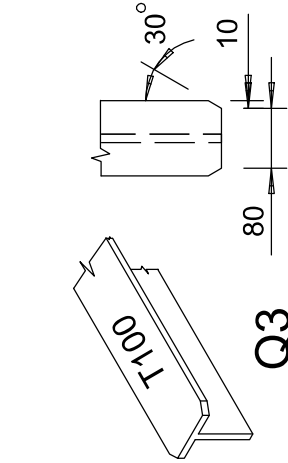
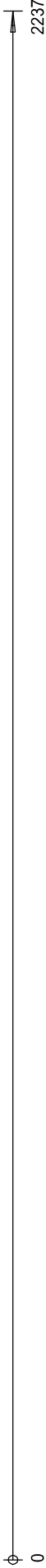

Q3

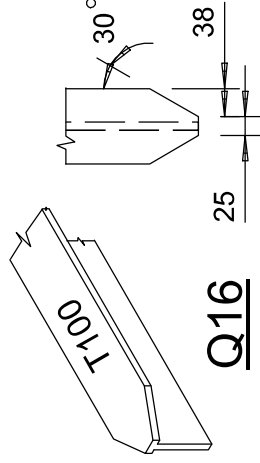

Q16

END	TYPE	A	B	C	R1	R2	V1	V2	V3	V4	KS	Excess	GAP	Bev	Web	TS	Bev	Web	OS	Nose	W	Bev	Face	TS	Bev	Face	OS	Nose	F	Endcut
LEFT	31			80	0		90	30	30	90				V	°	V	°	V	°			V	°	V	°	V	°			3102
RIGHT	31			25	0		90	30	30	90				V	°	V	°	V	°			V	°	V	°	V	°			3102