

Maksimiziranje korištenja otpadne topline iz industrijskih zona korištenjem "Total Site" metode

Kudeljan, Valentino

Undergraduate thesis / Završni rad

2016

Degree Grantor / Ustanova koja je dodijelila akademski / stručni stupanj: **University of Zagreb, Faculty of Mechanical Engineering and Naval Architecture / Sveučilište u Zagrebu, Fakultet strojarstva i brodogradnje**

Permanent link / Trajna poveznica: <https://urn.nsk.hr/urn:nbn:hr:235:499117>

Rights / Prava: [In copyright](#)/[Zaštićeno autorskim pravom.](#)

Download date / Datum preuzimanja: **2024-10-14**

Repository / Repozitorij:

[Repository of Faculty of Mechanical Engineering and Naval Architecture University of Zagreb](#)



UNIVERSITY OF ZAGREB
FACULTY OF MECHANICAL ENGINEERING AND NAVAL
ARCHITECTURE

BSC THESIS

Valentino Kudeljan

Zagreb, 2016.
UNIVERSITY OF ZAGREB
FACULTY OF MECHANICAL ENGINEERING AND NAVAL
ARCHITECTURE

BSC THESIS

Mentori:

Prof. dr. sc. Goran Krajačić, dipl. ing.

Dr. sc. Stanislav Boldyeyev, dipl. ing.

Student:

Valentino Kudeljan

Zagreb, 2016.

I declare that i developed this work independetly using knowledge achieved during my studies and references cited.

I thank my mentor Prof. dr. sc. Goran Krajačić who checked my work for errors and recomended me this topic for BSc thesis. In addition, I thank Dr. sc. Stanislav Boldyeyev who helped me numerous times with his expertise and who gave me the literature needed to finish this work. Also, the support by the EC and Croatian Ministry of Science Education and Sports project “CARBEN” (NEWFELPRO Grant Agreement No. 39).

Valentino Kudeljan



SVEUČILIŠTE U ZAGREBU
FAKULTET STROJARSTVA I BRODOGRADNJE



Središnje povjerenstvo za završne i diplomske ispite
 Povjerenstvo za završne ispite studija strojarstva za smjerove:
 procesno-energetski, konstrukcijski, brodogradnja i inženjersko modeliranje i računalne simulacije

Sveučilište u Zagrebu	
Fakultet strojarstva i brodogradnje	
Datum	Prilog
Klasa:	
Ur.broj:	

ZAVRŠNI ZADATAK

Student: Valentino Kudeljjan

Mat. br.: 0035188195

Naslov rada na hrvatskom jeziku: **Maksimiziranje korištenja otpadne topline iz industrijskih zona korištenjem „Total Site“ metode**

Naslov rada na engleskom jeziku: **Maximising of waste heat recovery of industrial regions using Total Site approach**

Opis zadatka:

Since their introduction in the late seventies of the last century, Pinch analysis and Process integration have been important tools for optimisation of energy use in different chemical or industrial processes. However, today in the world in the various industrial processes heat is consumed 50% more than it is really required according to the data of the globally well-known heat exchangers producer Alfa Laval. By development of energy planning software it is possible to design systems which will maximise use of waste heat not just in the individual plants but on the level of an industrial zone and wider city districts.

In the thesis it is necessary to complete the tasks outlined below:

1. Make literature review and describe „Total Site“ method for planning of an industrial zone.
2. Analyse the data of hot and cold streams in the hypothetical industrial zone which consists of two individual processes „A“ and „B“ and residential zone with individual process „C“.
3. Calculation of heating, cooling and recovery demands of individual processes „A“, „B“ and „C“ according to the input data.
4. Calculation of „Total Site“ heating, cooling and recovery demands for processes „A“, „B“ and „C“.
5. Development of site heat system for „A“, „B“ and „C“ with maximum recovery.
6. Calculation of energy saving potential and economic indicators for proposed solution if the price of hot utility is 366 EUR/kWy (prices of natural gas 0.042 EUR/kWh), the price of cold utility is 36 EUR/kWy, the specific price of heat transfer area is 800 EUR/m², installation costs with revamp of 1 heat exchanger are 10,000 EUR, the coefficient of nonlinearity of heat transfer area price is 0.87, plant life is 5 years and return on investment employed of 10%.

Necessary data and literature could be obtained from the supervisors. In the thesis, it is also necessary to state used literature and received help.

Zadatak zadan:

Rok predaje rada:

Predviđeni datumi obrane:

25. studenog 2015.

1. rok: 25. veljače 2016
2. rok (izvanredni): 20. lipnja 2016.
3. rok: 17. rujna 2016.

1. rok: 29.2., 02. i 03.03. 2016.
2. rok (izvanredni): 30. 06. 2016.
3. rok: 19., 20. i 21. 09. 2016.

Zadatak zadao:

Predsjednik Povjerenstva:

Doc. dr. sc. Goran Krajačić

Prof. dr. sc. Igor Balen

TABLE OF CONTENTS

TABLE OF CONTENTS.....	I
THE LIST OF FIGURES.....	II
THE LIST OF TABLES.....	III
THE LIST OF SYMBOLS.....	IV
SUMMARY.....	V
SAŽETAK.....	VI
PROŠIRENI SAŽETAK.....	VII
1. INTRODUCTION.....	1
2. METODOLOGY DESCRIPTION.....	2
2.1. Assignment data.....	2
2.2. Setting enery targets.....	2
2.2.1. The Minimum Temperature Difference (ΔT_{min}).....	2
2.2.2. Heat Recovery for Multiple Streams using the Composite Curves.....	3
2.3. Numerical targeting: the problem table algorithm.....	4
2.3.2. Construction of Grand Composite Curve (GCC).....	7
2.4. Total Site Profile (TSP).....	8
2.4.1. Finding the Pinch on TSPs.....	9
2.5. Heat transfer area.....	9
2.6. Heat exchanger network (HEN) synthesis.....	11
2.6.1. The design procedure of HEN grid diagram [1].....	11
3. CASE STUDY CALCULATIONS AND GRAPHICAL ABSTRACT.....	13
3.1. Initial data.....	13
3.2. Industrial process A.....	14
3.3. Industrial process B.....	20
3.4. Process C – Residential and commercial area.....	27
3.5. Total site.....	28
4. ECONOMIC ANALYSIS.....	36
5. CONCLUSION.....	40
REFERENCES.....	41
ATTACHMENTS.....	42

THE LIST OF FIGURES

Figure 1	The construction of hot composite curve [1].....	4
Figure 2	Pinch point for $\Delta T_{min} = 10^{\circ}\text{C}$ [1].....	4
Figure 3	Shifting temperature [1].....	5
Figure 4	Grand composite curve.....	8
Figure 5	Construction of the TSP [1].....	8
Figure 6	Finding the Pinch on TSP.....	9
Figure 7	Example of one enthalpy interval.....	10
Figure 8	Simple representation of HEN grid diagram [1].....	11
Figure 9	The table of streams.....	14
Figure 10	Cold Composite Curve (Process A).....	15
Figure 11	Hot Composite Curve (Process A).....	16
Figure 12	Combined Composite Curves (Process A).....	16
Figure 13	Grand Composite Curve (Process A).....	17
Figure 14	HEN grid diagram (Process A).....	19
Figure 15	The table of streams (Process B).....	20
Figure 16	Cold Composite Curve (Process B).....	21
Figure 17	Hot Composite Curve (Process B).....	22
Figure 18	Combined Composite Curve (Process B).....	22
Figure 19	Grand Composite Curve (Process B).....	23
Figure 20	HEN network grid diagram (Process B).....	25
Figure 21	The table of streams (Process C).....	27
Figure 22	Cold Composite Curve (Process C).....	27
Figure 23	The table of streams for total site.....	29
Figure 24	Total site stream profiles.....	30
Figure 25	Final Total site profile with intermediate utility.....	35

THE LIST OF TABLES

Table 1	The Problem Heat Cascade.....	6
Table 2	Final cascade with Pinch point.....	7
Table 3	Initial data.....	13
Table 4	Data table (Process A).....	14
Table 5	The Problem Heat Cascade (Process A).....	15
Table 6	The calculation of the heat transfer area of HEN (Process A).....	18
Table 7	Data table (process B).....	20
Table 8	The Problem Heat Cascade (Process B).....	21
Table 9	The calculation of the heat transfer area of HEN (Process B).....	24
Table 10	Data table (Process C).....	27
Table 11	Total site data.....	29
Table 12	The number of heat exchangers of source and sink streams.....	31
Table 13	Calculation of Intermediate utility 1-3.....	32
Table 14	Calculation of Intermediate utility 4-6.....	33
Table 15	The calculation of hot utility heat transfer surface.....	34
Table 16	Initial data for economic analysis.....	36
Table 17	Savings calculation.....	38
Table 18	Savings.....	39

THE LIST OF SYMBOLS

Label	Unit	Description
TS	°C	Starting temperature of the stream
TT	°C	Targeted temperature of the stream
CP	$\frac{kW}{°C}$	Heat capacity flow rate
$h, h_{s,i}$	$\frac{kW}{m^2 \cdot °C}$	The heat transfer coefficient for the stream
ΔH	kW	Delta enthalpy
ΔT_{min}	°C	Minimum temperature difference
ΔT_{LM}	°C	Logarithmic temperature difference
dTlog	m^2	The minimum surface of heat exchanger network
$A_{HEN,min}$	kW	Transferred heat
Q	kW	The heat transfer of one heat exchanger
Q_{HE}	kW	Heat for cold utility on one stream
C	kW	Heat for hot utility on one stream
H	kW	Overall hot utility heat transfer
Q_{HU}	kW	Overall cold utility heat transfer
Q_{CU}	Eur	Initial expense
IE	0	Number of heat exchangers
N_{HE}	Eur	Installation cost with revamp of 1 heat exchanger
ICR	Eur/ m^2	Specific price of heat transfer area
SPA	0	The number of enthalpy interval
EI	0	The number of stream
EI	kW	The enthalpy change of the stream
NS	°C	The temperature difference of hot and cold stream on the beginning of the enthalpy interval
$q_{s,i}$	°C	The temperature difference of hot and cold stream on the end of the enthalpy interval
$\Delta T_{eis}, dTa$	°C	The beginning of enthalpy interval
$\Delta T_{eie},$	kW	The end of enthalpy interval
dTb	kW	Temperature of hot stream on the beginning of the enthalpy interval
H1	°C	Temperature of hot stream on the end of the enthalpy interval
H2	°C	Temperature of hot stream on the end of the enthalpy interval
Ths	°C	Temperature of cold stream on the beginning of the enthalpy interval
The	°C	Temperature of cold stream on the end of the enthalpy interval
Tcs,T1	°C	Temperature of cold stream on the end of the enthalpy interval
	°C	The change of temperature of the stream in enthalpy

Tce, T2

dTstream

interval

SUMMARY

This BSc thesis assignment is tied to the project CARBEN. The 'Carbon footprint reduction and energy efficiency via development an advanced tehniques for Total Site integration' is a project which has been carried out on Faculty of mechanical engineering and naval architecture in Zagreb since 2014. The thesis has acomplished great benefits which will be explained in further text. The goal was to maximise the regeneration of heat on three seperate sites using Total site method and to calculate its potential of energy savings and economic indicators of saving money. The assignment has and industrial process A, industrial process B and residential and commercial area also known as process C. Each one of them has number of cooling and heating streams, as well as condensation and evaporation streams. Firstly, using basic Pinch method, the calculations led us to minimum hot and cold utility for minimum temperature difference of 10°C. Also, the calculations for heat exchanger network (HEN) were made, and all of the graphical apstract as well. Afterwards, the total site method was applied for these minimum hot and cold utilities, and the calculation of HEN inside the total site. Also, the intermediate utility was defined using minimum heat transfer area of the heat exchangers. Using all these calculations and obtained results, the economic analysis was made. The goal was to see what is the difference of costs for processes with regeneration and without it. The provided data such as installation of heat exchangers, money discount rate, cost of one squared meter of heat transfer surface and nonlinearity coefficient of price of the heat transfer surface was used. The results were astonishing, the regeneration acomplished is 4433kW for cold and hot utility, and only 1778,85kW of additional hot utility was needed and no cold utility at all because all hot streams were cooled down via regeneration. The result was **2.921.058,15 euros** of present value money of savings in 5 years compared with processes without regeneration. The expenses for installation and revamp were included and they were around 378.564 euros. Also, the benefits beside capital profits are lower carbon emissions, which are of great importance in todays world.

Key words:

Total site, regeneration, heat exchangers, capital cost, revamp, graphical apstract, network, hot, cold, economy, Pinch, surface, transfer, analysis, shifting, temperature, composite curve, intermeduete utility, hot utility, cold utility, profile.

SAŽETAK

Ovaj je završni zadatak vezan za projekt CARBEN. 'Carbon footprint reduction and energy efficiency via development an advanced tehniques for Total Site integration "je projekt koji se provodi na Fakultetu strojarstva i brodogradnje u Zagrebu od 2014. godine teži postignućima koje će biti objašnjene u daljnjem tekstu. Cilj je bio povećati regeneraciju topline na tri odvojena mjesta korištenjem Total site metode i izračunati potencijal uštede energije i ekonomske pokazatelje štednje novca. Zadatak zadaje industrijski proces A, industrijski proces B i stambeno područje C. Svaki od njih ima više struja hlađenja i grijanja, kao i kondenzacije i isparavanja. Prvo, pomoću Pinch metode, izračun nas je doveo do minimalne topline grijanja i hlađenja uzimajući u obzir minimalnu temperaturnu razliku od 10 ° C. Također, izračunata je mreža izmjenjivača topline, kao i grafički prikaz mreže. Nakon toga primijenjena je Total site metoda na minimalnu potrebnu dovedenu i odvedenu toplinu, kao i izračun mreže izmjenjivača na Total siteu. Također je definiran medij preko kojeg se prenosi toplina unutar total sitea preko minimalnih površina potrebnih za provođenje topline. Koristeći dobivene i izračunate podatke izvedena je ekonomska analiza. Cilj je vidjeti razliku potrošnje između izračunate regeneracije topline u odnosu na procese bez ikakve regeneracije. Korišteni su podaci poput cijene izmjenjivača, diskontne stope, cijene površine izmjenjivača za izmjenu topline i koeficijent nelinearnosti između površine izmjenjivača i cijene po metru kvadratnom izmjenjivačke površine. Rezultati su pokazali regeneraciju od 4433 kW, s time da odvođenje topline izvana nije uopće potrebno, pošto su se vruće struje dovele na definiranu temperaturu isključivo regeneracijom, a vanjsko dovođenje topline potrebno je samo 1778,85 kW. Rezultirajuća ušteda unutar 5 godine ja **2.921.058,15 eura** današnje vrijednosti novca u odnosu na procese bez regeneracije topline. Troškovi ugradnje izmjenjivača i trošak samih izmjenjivača iznosi 378.564 eura. Također je velika prednost postrojenja s regeneracijom topline niža emisija ugljičnog dioksida, što je od velike važnosti za današnji svijet. Težnja za manjim emisijama u svjetskoj politici je velika zbog sve većih utjecaja zagađivača na okoliš, te brojnih posljedica koje proizlaze iz toga.

Ključne riječi:

Total site, izmjenjivači, Pinch, metoda, mreža, procesi, ušteda, okoliš, diskontna stopa, regeneracija, toplina, efikasnost, temperatura, razlika, medij, temperatura, ekonomska analiza, površine, struje, odvođenje, dovođenje.

PROŠIRENI SAŽETAK

Razvojem tehnologije svijet se doveo u poziciju ekoloških problema. Visoke emisije ugljičnog dioksida predstavljaju problem nastajanjem efekta staklenika. Također osiromašuju se neobnovljivi izvori energije iz godine u godinu. Naša je dužnost brinuti se za ekosustav i što više smanjiti korištenje neobnovljivih izvora energije i ograničiti emisiju ugljičnog dioksida koliko god je moguće. Obnovljivi izvori energije masovno se koriste za manje potrebe, a zbog velikog investicijskog troška i raznih drugih faktora dolazimo do problematike korištenja obnovljivih izvora energije u industriji.

Ovaj završni rad govori o maksimiziranju korištenja otpadne topline iz industrijskih zona korištenjem "Total Site" metode. Cilj je maksimalno smanjiti potrebu za dodatnim eksternim grijanjem i hlađenjem vrućih struja medija unutar procesa kako bi se postignula dugoročna ušteda unutar 5 godina i smanjila emisija ugljičnog monoksida i ostalih štetnih plinova koji su nusprodukt dobivanja topline raznim neobnovljivim izvorima energije. Zadana su dva individualna pogona A i B, te je zadano stambeno područje C naslonjeno na industrijsku zonu. U ovom radu proračunate su potrebe grijanja, hlađenja, regeneraciju topline pomoću mreže izmjenjivača topline, te potencijal ušteda energije i ekonomske indikatore uz diskontnu stopu od 10%. Dodatni ulazni podaci mogu se pronaći u Tablici 1. Pogoni se sastoje od raznih vrućih i hladnih struja s ulaznim temperaturama i izlaznim temperaturama, kao i struja koje kondenziraju i isparuju. Zadana je i promjena entalpije koja prikazuje količinu topline koju svaka struja mora izmijeniti. Također pod "CP" zadan je toplinski kapacitet. Uz navedene podatke zadan je i faktor toplinske provodljivosti izražen u kilovatu po metru kvadratnom i stupnju celzijusu. Uz tehničke podatke vezane za postrojenja, zadana je i cijena toplinske energije od 366 EUR/kWy, cijena hlađenja od 36 EUR/kWy, specifična cijena površine izmjenjivača od 800 EUR/m², cijena instalacije jednog izmjenjivača topline od 10 000 EUR, koeficijent nelinearnosti izmjenjivačke površine i cijene po površini koji iznosi 0,87, životni vijek postrojenja od 5 godina, te diskontna stopa od 10 %.

Prvi je korak razviti proračun u Excelu za energetske ciljeve. Minimalno grijanje i hlađenje uz maksimalnu regeneraciju računa se pomoću termodinamičkih ograničenja. Potrebno je naći granicu uz određenu minimalnu toplinsku razliku pri kojoj će regeneracija energije biti maksimalna. Korištenjem Pinch tehnologije moguće je izračunati energetske ciljeve koji optimiziraju investiciju i uštedu postrojenja mijenjanjem minimalne temperaturne razlike između struja u izmjenjivaču. U ovom je radu zadana minimalna temperaturna razlika od 10°C od strane mentora. Inače, minimalna je toplinska razlika proporcionalna površini koja je potrebna u izmjenjivaču za izmjenu topline. Što je temperaturna razlika manja, to je površina veća, a za temperaturnu razliku od 0°C bi teoretski površina trebala biti beskonačna zbog nedostatka razlike temperature struja koja pogoni izmjenu topline. Dakle, što je manja minimalna temperaturna razlika, to je investicija veća, ali i ušteda na energiji.

Process A – industrial						
Stream	Type	TS (°C)	TT (°C)	CP (kW/°C)	ΔH (kW)	h (kW/(m ² C))
Stream 1 cooling	Hot	90	40	8.325	416.3	1.2
Stream 2 condensation	Hot	64	64	185*	183.4	5.3
Stream 3 condensation	Hot	110	110	2296*	265.9	6.2
Stream 4 cooling	Hot	120	40	1.307	104.5	1.0
Stream 5 cooling	Hot	110	40	0.487	34.1	1.0
Stream 6 heating	Cold	18	55	17.460	646.0	1.0
Stream 7 heating	Cold	40	120	0.544	43.6	1.2
Stream 8 evaporation	Cold	121	121	2254*	261.1	5.5
* – latent heat of phase change						
Process B – industrial						
Stream	Type	TS (°C)	TT (°C)	CP (kW/°C)	ΔH (kW)	h (kW/(m ² C))
Stream 1 cooling	hot	60	55	9.312	46.56	0.8
Stream 2 condensation	hot	90	60	2.682	80.45	0.8
Stream 3 condensation	hot	61	61	2355*	369.40	6.0
Stream 4 condensation	hot	75	75	2336*	725.50	6.0
Stream 5 condensation	hot	95	75	2.654	53.08	1.2
Stream 6 evaporation	cold	109	109	2264*	381.11	6.0
Stream 7 evaporation	cold	114	114	2141*	703.10	6.0
Stream 8 heating	cold	55	90	2.682	93.86	0.8
Stream 9 heating	cold	60	109	2.721	133.30	0.8
Stream 10 heating	cold	50	80	1.493	44.80	1.0
Stream 11 heating	cold	20	36	18.620	298.00	1.0
Stream 12 heating	cold	45	75	11.640	349.20	1.3
Stream 13 heating	cold	75	102	5.250	141.80	1.4
* – latent heat of phase change						
Process C – residential and commercial area						
Stream	Type	TS (°C)	TT (°C)	CP (kW/°C)	ΔH (kW)	h (kW/(m ² C))
Heating of power substation	cold	50	90	3.490	139.6	1.0
Hot water of residential area	cold	20	50	16.296	488.9	1.0
Hot water of commercial area	cold	20	50	6.984	209.5	1.0

Tablica 1 **Ulazni podaci**

Za početak analize svi su podaci prebačeni u Excel. U svrhu konstruiranja kompozitnih krivulja topline su pomaknute. Toplim je strujama smanjena temperatura za pola od minimalne razlike, a hladnim povećana. Tim smo načinom postigli da na mjestu dodira krivulja još uvijek postoji minimalna temperaturna razlika, a time i dovoljna razlika potencijala za izmjenu topline. Za tople struje postoji jedna kompozitna krivulja, a za hladne struje druga. Svaka je krivulja definirana temperaturama i razlikom entalpija koji tvore temperaturno-entalpijski profil.

Konstrukcija krivulja biti će objašnjena u daljnjem tekstu, ali je prije toga potrebno napraviti kaskadni dijagram kako bi mogli pravilno pozicionirati krivulje, odnosno kako bi pronašli Pinch točku. Pinch točka je mjesto gdje krivulje imaju minimalnu temperaturnu razliku. Kaskadni je dijagram sredstvo izračunavanja Pinch točke numeričkim putem, a sastoji se od 5 koraka.

Prvi je korak pomicanje temperatura kako je već objašnjeno u prijašnjem tekstu i napravljeno u samom početku. Drugi je korak određivanje temperaturnih granica, odnosno podjela svih struja na intervale. U svrhu toga sve se temperature struja poredaju u padajućem nizu, a temperature koje se ponavljaju izbrisu se, izuzev onih koje se ponavljaju zbog promijene agregatnog stanja medija, odnosno isparavanja ili kondenzacije. Treći je korak da se unutar svakog intervala toplinski kapacitet struja koje su uključene u taj interval izbroje. Radi lakšeg zbrajanja kapaciteta napravljena je tablica struja u kojoj je to jasno prikazano (Slika 1, 2, 3).

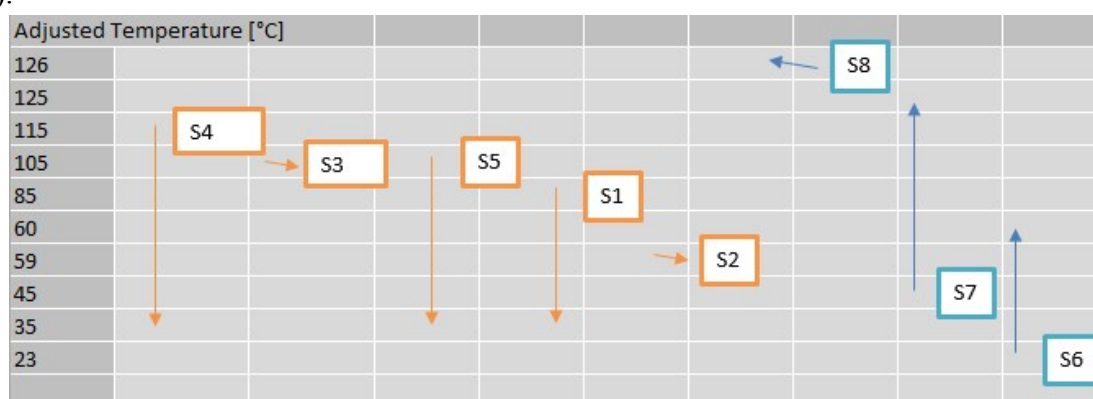

Slika 1 Tablica struja za Proces A

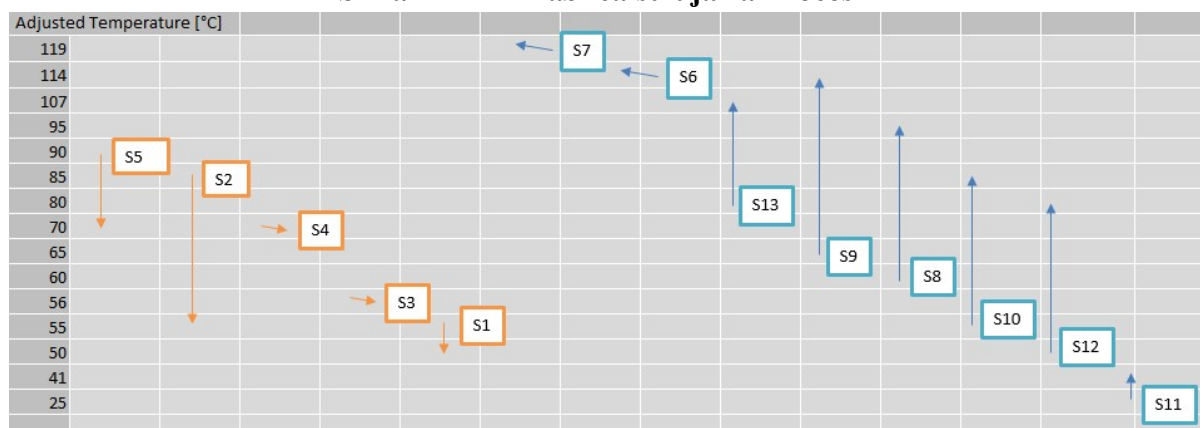

Slika 2 Tablica struja za Proces B

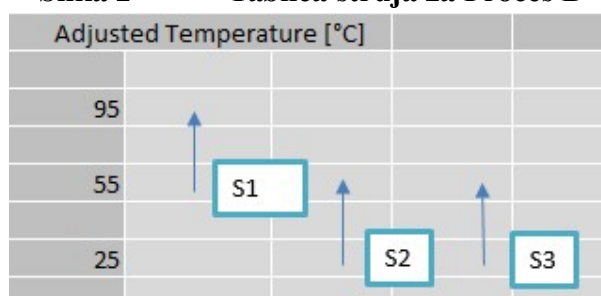

Slika 3 Tablica struja za Proces C

U četvrtom se koraku stvara kaskada s pretpostavkom da se ne dovodi toplina. Kao što je prikazano u tablicama 2 i 3, svaki temperaturni interval ima svoj redak koji sastoji entalpijski interval tog temperaturnog intervala koje smo dobili umnoškom zajedničkog toplinskih kapaciteta i promijene temperature u °C za taj interval, a kaskada se proračuna tako da se u prvom temperaturnom intervalu upiše promjena entalpije, a u svakom idućem zbroji kaskadni rezultat iz prošlog intervala.

U posljednjem, petom, koraku potrebno je identificirati minimum unutar kaskade. Nakon toga korak četiri ponavlja se u novom stupcu, s time da je početni broj u kaskadi upravo taj minimalan broj unutar prošle kaskade, ali s obrnutim predznakom. Na taj se način dobila Pinch točka na 115°C za pogon A, te na 75°C za pogon B Time je proces numeričkog određivanja Pinch točke završen, te se može nastaviti izrada grafičkog prikaza. Također smo dobili i minimalnu potrebnu dovedenu toplinu iz vanjskog izvora, te minimalno potrebno hlađenje struja.

T Interval [°C]	H Interval [kW]		kW	
0	-261,10	Cascade	266,54	Min hot utility
10	-5,44	-266,54	5,44	
10	7,63	-258,91	0,00	Pinch = 115°C
0	265,90	6,99	7,63	Hot Pinch 120°C Cold Pinch 110°C
20	25	31,99	273,53	
25	239,375	271,365	298,53	
1	-7,885	263,48	537,91	
0	183,40	446,88	530,02	
14	-110,39	336,49	713,42	
10	-73,41	263,08	603,03	
12	-209,52	53,56	529,62	
			320,1	Min cold Utility
				Recovery 1004,20 kW

Tablica 2 Kaskada za Proces A

T Interval [°C]	H Interval [kW]		kW	
0	-703,10	Cascade	1458,219	Min heat utility
5	-381,11	-1084,21	755,12	
7	-19,047	-1103,26	374,01	
12	-95,65	-1198,91	354,96	
5	-53,265	-1252,17	259,31	
5	-39,995	-1292,17	206,05	
5	-34,05	-1326,22	166,05	
10	-132,00	-1458,22	132,00	
0	725,50	-732,72	0,00	Pinch = 70 Hot Pinch 75°C
5	-79,27	-811,99	725,50	Cold Pinch 65°C
5	-65,665	-877,65	646,23	
4	-41,804	-919,46	580,57	
0	369,40	-550,06	538,76	
1	-10,451	-560,51	908,16	
5	-11,64	-572,15	897,71	
9	0	-572,15	886,07	
16	-297,92	-870,07	886,07	
			588,15	Min cold Utility
			Recovery 1275,00 kW	

Tablica 3 Kaskada za Proces B

Konstrukcija kompozitnih krivulja radi se na način da se odrede temperaturni intervali za tople struje i za hladne struje na isti način kao i za kaskade, te im se pridodaje određena promjena entalpije unutar intervala dobivena množenjem temperaturnog intervala i toplinskih kapaciteta intervala. Nakon toga temperaturni intervali mogu se pomaknuti nazad na početne vrijednosti za polovinu minimalne temperaturne razlike, a početna entalpija tople kompozitne krivulje je 0, dok je početna entalpija hladne kompozitne krivulje jednaka upravo minimalnoj potrebnoj količini odvedene topline dobivene kaskadom. Dobivene krivulje prikazane su u slikama 4, 5 i 6.

Pinch (°C)	Min. Cold (kW)	Min. Hot (kW)
115	320,1	266,54

Combined Composite Curve

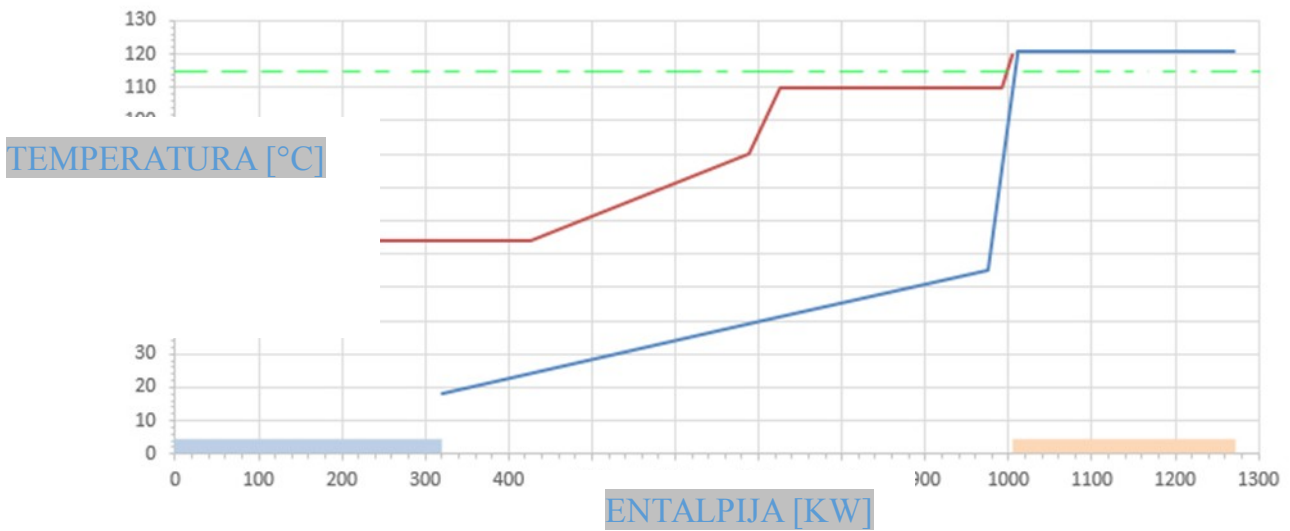

Slika 4 Kombi je (Proces A)

Pinch (°C)	Min. Cold (kW)	Min. Hot (kW)
70	588,15	1458,219

Co

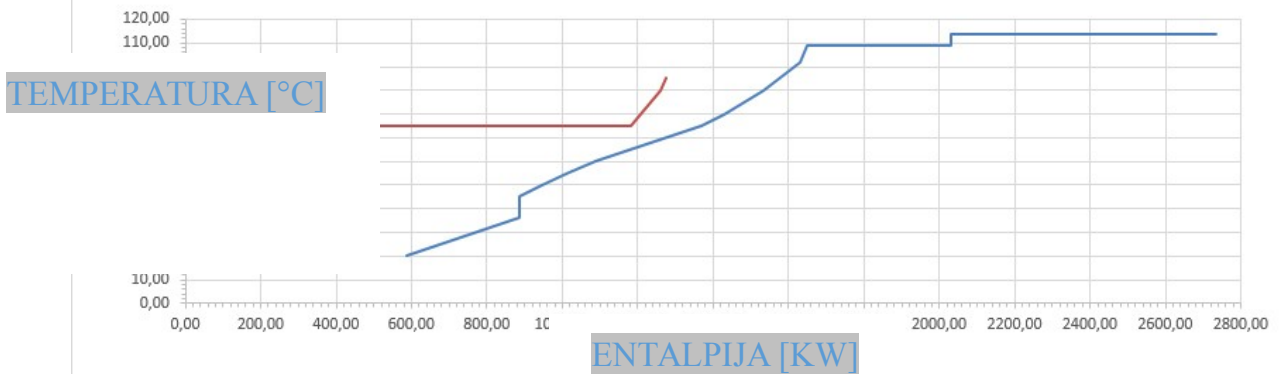

Slika 5 Spc (Proces B)

Cold Composite Curve	
T[°C]	H [kW]
25	0
55	697,59
95	837,19

TEMPERATURA [°C]

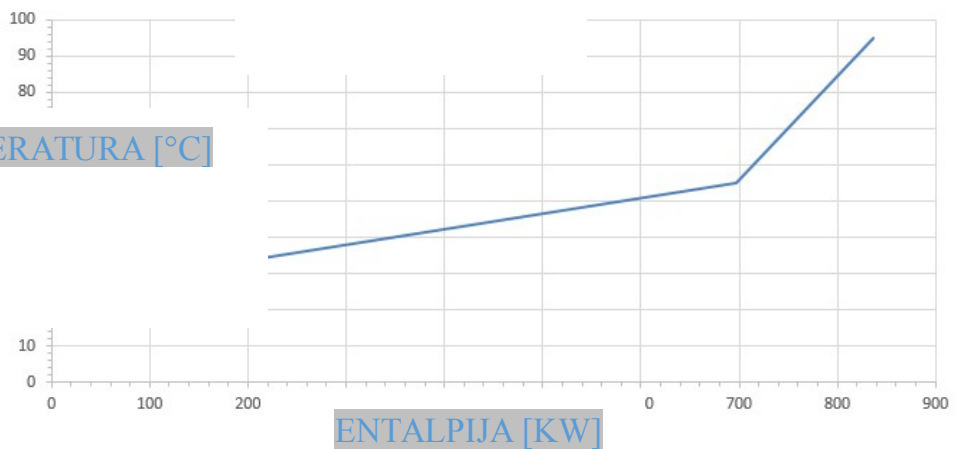

Slika 6 Hladna ces C) 1 zajedničku kompozitnu Za potrebe "Total Site" metode pe

i broj izmjenjivača na zasebnim pogonima, te je time analiza pogona svršena, a može se nastaviti s Total site metodom i ekonomskom analizom.

Proračun površine izmjenjivača je slijedeći. Proračuna se potrebna minimalna površina izmjenjivača za svaki entalpijski interval zasebno. Intervali se određuju tako da unutar svakog intervala imamo iste struje od početka do kraja istog. Nakon svakog ubacivanja ili izbacivanja nove struje kreće novi entalpijski interval. Slijedeća formula koristi se za proračun površine.

$$A_{HEN,min} = \sum_{i=1}^{EI} \left(\frac{1}{\Delta T_{LM,i}} \sum_{s=1}^{NS} \frac{q_{s,i}}{h_{s,i}} \right) \quad (1)$$

*REF*_{Ref 287447026}

EI i NS označavaju entalpijske intervale i struje unutar intervala. $\Delta T_{LM,i}$ označava logaritamsku temperaturnu razliku unutar intervala koji se izračuna pomoću formule (2).

$$\Delta T_{LM} = \frac{\Delta T_{eis} - \Delta T_{eie}}{\log \left(\frac{\Delta T_{eis}}{\Delta T_{eie}} \right)} \quad (2)$$

" $q_{s,i}$ " označava promijenu entalpije određene struje, a " $h_{s,i}$ " koeficijent provodljivosti struje. Unutar proračuna za logaritamsku temperaturnu razliku ΔT_{eis} i ΔT_{eie} su razlike temperatura tople i hladne struje na početku entalpijskog intervala, te na njegovom kraju.

Proces A zahtjeva površinu izmjenjivača od 21,62 kvadratna metra, a proces B od 44,77 kvadratna metra. Metoda korištena za proračun broja izmjenjivača naziva se sinteza mreže izmjenjivača topline. Postala je popularna zbog svoje jednostavnosti i preglednosti u odnosu na ostale metode. Slika 9 prikazuje sintezu za Proces A. Slika je zapravo mrežni dijagram mreže izmjenjivača koji pokazuje sve hladne i tople struje, te izmjenjivače između njih. Sav višak i manjak topline za određen proces prikazan je sa H i C. Dijagram točno prikazuje početne i krajnje temperature struja. Za konstrukciju ovakvog dijagrama potrebno je pratiti tri pravila. Nijedan izmjenjivač ne smije imati manju temperaturnu razliku od minimalne već određene, toplina se ne može prenositi u samoj pinch točki, te se ne smije primijeniti odvođenja i dovođenja topline veće od izračunatih minimalnih. Također nije dopušteno prenošenje topline sa područja ispod Pinch točke na područje iznad Pinch točke, a općenito odvođenja s područja iznad pinch točke na područja ispod nisu preporučana zbog uobičajenog potrebnog dodatnog eksternog odvođenja topline.

Analizom prikazana je potreba za 3 izmjenjivača kod Proces A, te 7 izmjenjivača kod procesa B. Ovime je završena analiza pojedinih pogona, te se može krenuti na Total Site metodu.

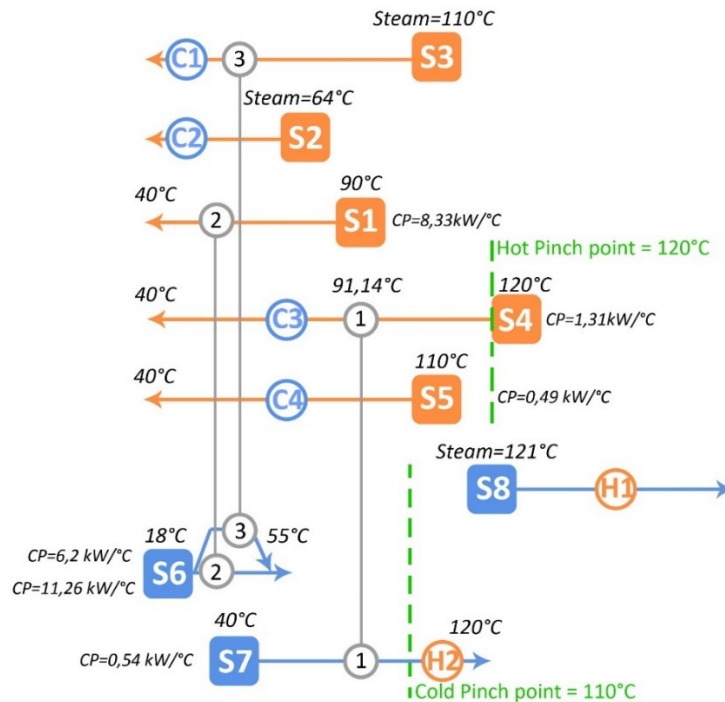

Slika 9 Mreža izmjenjivača topline (Proces A)

Podaci za total site metodu uzimaju se uz pomoć zajedničkih kompozitnih krivulja, kako je već i navedeno. Izuzmu se struje koje su van regeneracijskih džepova. Tablica 4 prikazuje potrebne podatke. Podaci su podijeljeni na pogone, a unutar svakog pogona nalaze se neregenerirane struje ili dijelovi tih struja koji su jasno prikazani u zajedničkim kompozitnim krivuljama. U svrhu konstruiranja kompozitnih total site profila temperature struja su uz već pomaknute profile za polovinu minimalne temperaturne razlike pomaknute za još taj iznos, tako da su hladna i topla kompozitna krivulja total sitea pomaknute jedna prema drugoj za iznos koji je dva puta veći od minimalne temperaturne razlike. Razlog tome je medij koji preuzima toplinu s vruće struje i predaje hladnoj, te na taj način osiguravamo da krivulje i pri samom dodiru na grafičkom prikazu imaju realnu temperaturnu razliku između prenosivog medija jednaku minimalnoj predodređenoj temperaturnoj razlici od 10 °C. Sama konstrukcija profila uključuje četiri jednostavna koraka. Prvi je korak već objašnjen a sastoji se od izdvajanja krivulja iz zajedničke kompozitne krivulje. Nakon toga se sve struje sa negativnim nagibom, odnosno sve struje koje predaju toplinu zrcalno preslikavaju da imaju pozitivan nagib. Nakon toga stvaraju se kompozitne krivulje za vruće struje na isti način kao i kod zasebnih pogona uz pomoć tablice struja, a zadnji je korak postavljanje krivulja tako da se vruće struje nalaze lijevo od temperaturne osi, a hladne desno. Nakon same konstrukcije krivulje se pomiču po X osi u svrhu pronalaženja pinch točke profila. Topla krivulja koja se nalazi s lijeve strane temperaturne osi miče se prema hladnoj. Jednostavno se profilnim točkama dodaje potrebna entalpija tako da jedna od temperatura obje krivulje ima jednaki iznos entalpije, ali pod uvjetom da se krivulje ne presjeku, nego da tangiraju. Također se može napraviti ista stvar kaskadnim dijagramom, ali u ovom slučaju nije za njim bilo potrebe.

	Ts [°C]	Te [°C]	Tstart* [°C]	Tend* [°C]	Tstart** [°C]	Tend** [°C]	dH [kW]	CP [kW/°C]	streams
A	Sink A1	121	126	126	131	131	261,10		S8
	Sink A2	110	115	125	120	130	5,44	0,54	S7
	Source A1	120	115	105	110	100	7,63	1,31	s4
	Source A2	110	105	105	100	100	265,90		S3
	Source A3	110	105	105	100	80	25,00	1,79	s5+s4
	Source A4	90	85	83	80	78	21,57	10,12	S5+S4+S1
	Sink B1	114	119	119	124	124	703,10		s7
	Sink B2	109	114	114	119	119	381,11		s6
B	Sink B3	102	107	114	112	119	19,05	2,72	S9
	Sink B4	90	95	107	100	112	95,65	7,97	S13+S9
	Sink B5	85	90	90	95	100	53,27	10,65	S13+S9+S8
	Sink B6	80	85	85	90	95	40,00	10,65	S13+S9+S8
	Sink B7	75	80	80	85	90	34,05	12,15	S13+S9+S8+S10
	Sink B8	65	70	70	75	85	132,00	18,54	S9+S8+S10+S12
	Source B1	75	70	70	65	65	538,76		s4
	Sink C1	50	55	55	60	100	139,60	3,49	Sc1
Sink C2	20	25	25	30	60	697,59	23,28	Sc2+Sc3	
Tstart* temperature moved by 5°C from Ts									
Tstart** temperature moved by 10°C from Ts									

Tablica 4 Podaci za total site

Postavljanje među struje vrši se metodom minimalne površine izmjenjivača. Total site profili podijele se na entalpijske intervale, s tim da u ovom slučaju postoje i intervale koji u ovom slučaju nemaju stalno iste struje uz duž svakog intervala jer je takva podjela nepotrebna. Neke struje imaju premalen utjecaj, pa su uključene unutar intervala nakon samog početka, no to je ionako uključeno u proračun. Podjela profila sastoji se u ovom slučaju od 6 entalpijskih intervala određenih sa početnom i krajnjom entalpijom u intervalu. Upisani su posebno podaci za hladnu i za toplu struju gdje "Tsa" i "Tsb" označavaju temperaturu na početku intervala od tople i hladne struje, a Tea i Teb temperature na kraju intervala. Odredi se toplina koju je potrebno regenerirati, a određena je duljinom entalpijskog intervala. Broj izmjenjivača određuje se tako da se izbroji koliko različitih struja ima, te se za svaku novu struju uvodi novi izmjenjivač, a dolazi se do 6 izmjenjivača za vruću struju, te 8 izmjenjivača potrebnih za prijenos topline između hladne struje i među struje.

Unutar se svakog intervala postavi među struja različitih temperatura, s uvjetom da temperaturna razlika nije manja od minimalne između među struje i ito jedne druge, te se za svaku verziju izračuna površina prema već prikazanoj formuli (1) za minimalnu površinu izmjenjivača. Dobiveni grafički prikaz krivulja prikazan je na slici 10, a ukupna potrebna površina iznosi 138,39 metara kvadratnih.

Zadnji je korak proračun površine izmjenjivača i broja izmjenjivača za eksterni izvor topline koji nije ušao u regeneraciju. Postavi se dostupan medij dostupne temperature i površina se proračuna prema već poznatom modelu, a rezultat je 9 izmjenjivača ukupne površine od 49,94 kvadratna metra.

Sink		Source		Final Intermediate Utility profile	
T[°C]	H [kW]	T[°C]	H [kW]	T[°C]	H [kW]
20	-176,278	120	876,406444	45	-176,2783
50	521,3117	110	863,336444	55	0
55	538,7617	110	597,436444	65	538,760953
65	573,6617	90	561,556444	67,74726	634,1728
67,747258	634,1728	87,74726	538,760953	71,53145	538,760953
70	683,7917	75	538,760953	77,74726	561,556444
75	793,9217	75	0	85	597,436444
80	872,1017			100	597,436444
85	942,8167			100	793,9217
90	1013,532			100	863,336444
100	1093,242			100	876,406444
102	1109,184			131	876,406444
109	1128,231			131	2478,9807
109	1509,341				
110	1509,341				
114	1511,517				
114	2214,617				
120	2217,881				
121	2217,881				
121	2478,981				
Hot utility	1778,853 kW				

Aiu	138,392152
Ahu	49,9443797
Ahen,a	21,6161434
Ahen,b	44,7710141
Ahen	254,723689

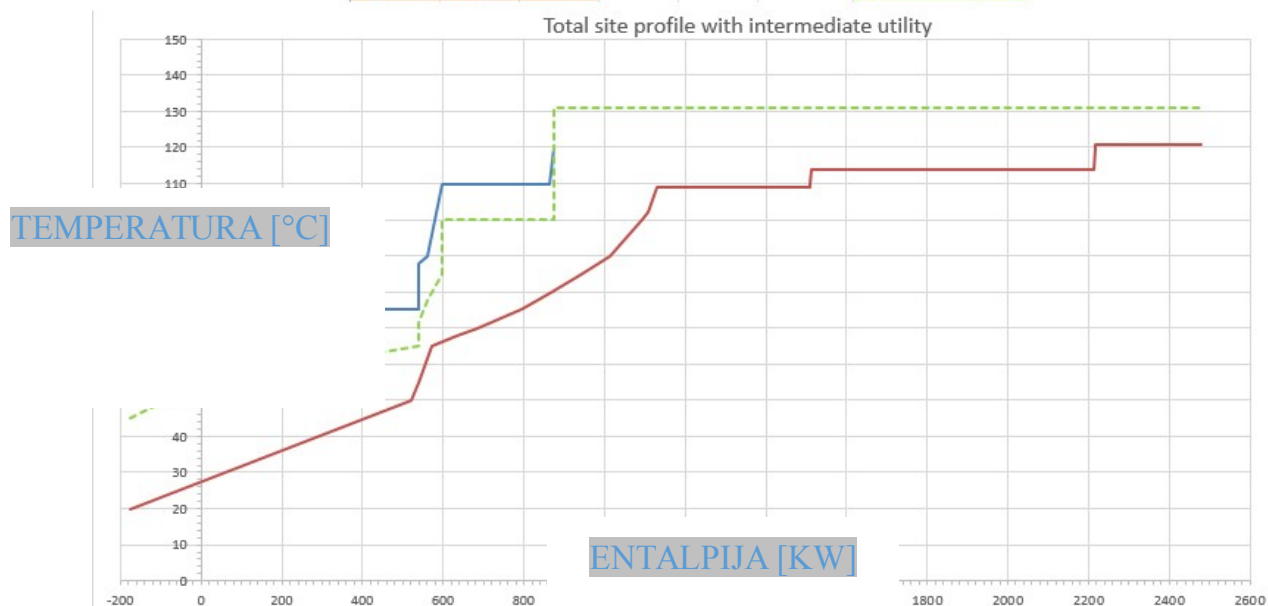

Slika 10 Total site profil

nim dovođenjem topline

Nakon proračuna svih potrebnih podataka vrši se jednostavna ekonomska analiza kojom se uspoređuje trošak pogona sa total site regeneracijom i samo sa regeneracijom unutar zasebnih pogona, te usporedba između total site regeneracije i bez ikakve regeneracije u pogonima. Proračuna se investicijski trošak za total site regeneraciju, te cijena dodatno uvedene topline iz vanjskih izvora. Naravno, dosadašnjim proračunom prikazano je kako potrebe za odvođenjem više uopće nema zbog potrebnog hlađenja regeneracijom.

Year	0	1	2	3	4	5
Savings A [EUR]	-264.537,87	319.310,30	319.310,30	319.310,30	319.310,30	319.310,30
Savings B [EUR]	-378.564,71	870.432,20	870.432,20	870.432,20	870.432,20	870.432,20
NPV A [EUR]	-264.537,87	290.282,09	263.892,81	239.902,55	218.093,23	198.266,57
NPV B [EUR]	-378.564,71	791.302,00	719.365,45	653.968,59	594.516,90	540.469,91
TOTAL NPV A [EUR]		945.899,39				
TOTAL NPV B [EUR]		2.921.058,15				

Tablica 5 Ušteda

U tablici 5 prikazana je godišnja ušteda. "Savings A" prikazuje uštedu između total site regeneracije i regeneracije samo unutar pogona, a "Savings B" uštedu između total site regeneracije i procesa bez ikakve regeneracije. Ušteda A iznosi **945.899,39 eura**, dok ušteda B iznosi **2.921.058,15 eura**. Ove su uštede unutar 5 godina vrlo velike, a unutar tih ušteda uračunata je sadašnja vrijednost novca uz diskontnu stopu od 10%, te investicijski trošak. Svi pokazatelji ukazuju na veliku profitabilnost ovakvog projekta jer jednostavno nema negativnih strana. Ušteda je velika, a emisija dioksida i ostalih zagađivača znatno smanjena zbog iznosa ukupno regenerirane topline od 4433 kW, dok eksterno dovodenje topline iznosi samo 1778,85 kW.

1. INTRODUCTION

Since the beginning of electricity based and technology steered world developed mostly by using earth's resources there has been notable leap in technology development. It has led us to the major world development, but also towards higher CO₂ emissions which led us to unstable eco system and greenhouse effect and towards lowering earth's resources. It is of great importance to use all our technological advance to lower the consumption of non-renewable sources of energy and to lower the CO₂ emissions as much as possible. More recently, the fluctuations and often large increases in the prices of oil and gas has increased the interest for using lower or non-carbon based energy sources. These environmental and costs concerns have led to increases of the industrial sector's efficiency of energy use, although the use of renewable sources in mayor industry has been sporadic.[1] On the other side, domestic energy supply via renewable sources in last years has shown noticeable growth. However, there has been only limited attempts to design a combined energy system that includes both industrial and residential buildings, and a few systematic design techniques have been marshaled toward the end of producing a symbiotic system.

This BSc theses about maximizing of waste heat recovery of industrial regions using Total Site approach is using some of the developed methodologies to calculate heating, cooling and recovery demands of industrial processes A and B and residential area C, calculate Total Site heating and cooling demands, develop the site heat systems with maximum recovery, calculate energy saving potential and economic indicators.

In favor of energy efficiency the calculation of heating and cooling demand in separate industrial processes and Total site, extended pinch technology method is used for improving energy efficiency through better design. Pinch technology is in use for more than 20 years and through feedback from practical applications and industry professionals it has been improved continuously. In addition, the Process Integration is used to maximize waste heat efficiency in Total site. Process Integration (PI) is a family of methodologies for combining several processes to reduce consumption of resources and harmful emissions. This energy saving methodology has been used in processing and power generation industry over the last 30 years. [1] It examines the potential for improving and optimizing the heat exchange between heat sources and heat sinks in order to reduce the amount of external heating and cooling required, thereby reducing costs and emissions.

2. METODOLOGY DESCRIPTION

2.1. Assignment data

The initial data is presented in tabular format. Processes are made of number of different streams where each heating demand is referred to as a cold stream and, conversely, each cooling demand as a hot stream. As shown in table 3, the data for each stream separately is provided as following:

- Starting temperature (TS),
- Targeted temperature (TT),
- Heat capacity flow rate (CP) which is a product of the mass flow rate of the corresponding stream and specific heat capacity

$$CP = m_{stream} \cdot C_{p, stream}$$

- The delta enthalpy (ΔH) which shows how much heat the stream has to receive or emit and
- The heat transfer coefficient (h) for the stream.

In addition, the data for economical analysis is provided:

- Price of hot utility,
- Price of cold utility,
- Specific price of heat transfer area,
- Installation costs with revamp of 1 heat exchanger,
- The coefficient of nonlinearity of heat transfer area,
- Plant life and
- Return on investment employed.

2.2. Setting energy targets

The utility usage and heat exchange area is calculated by using thermodynamic bounds on heat exchangers. We get lower bound on the utility demands and a lower bound on the required heat transfer area. These bounds are also known as targets. Using Pinch technology we can calculate targets which minimize the total cost of the heat exchanger network (HEN) being designed.

2.2.1. The Minimum Temperature Difference (ΔT_{min})

The heat exchanger area required is proportional to the temperature difference between the streams. The minimum allowed temperature difference in HEN design is the lower bound on any temperature difference to be encountered in any heat exchanger in the network. Its value is a design parameter which is determined by exploring the trade-offs between more heat recovery and the larger heat transfer area requirement. Increasing the value results in larger minimum utility demands and increased energy costs, but it reduces the heat transfer area and its corresponding investment costs. If the ΔT_{min} is reduced then utility costs go down, but investment costs go up [1]. In this case minimal temperature difference is set to 10°C by mentor.

2.2.2. Heat Recovery for Multiple Streams using the Composite Curves

Firstly, the beginning of the analysis is combining all hot and cold streams into two composite curves (CCs). For each process there are two curves, one hot composite curve (HCC) and one cold composite curve (CCC) which are consisted of hot and cold streams in the process. Each curve is defined by various temperature and enthalpy data which make temperature-enthalpy profile, representing the overall heat availability in the process (HCC) and overall heat demands of the process (CCC).

For construction of HCC it is necessary to determine all temperature intervals formed by the TS and TT of the process streams (Figure 1 (a)). Within each temperature interval, a composite segment is formed which is consisted of temperature equal to that of the interval and a total cooling requirement equal to the sum of the cooling requirements of all streams within the interval. This can be achieved by summing up the CP of the streams crossing the interval (Figure 1 (b)). the composite segments from all temperature intervals are combined to form the HCC. The construction of CCC is analogous.

The CCs are combined in the same graph to see the overlapping of the curves for maximum recovery. Although both HCC and CCC can be shifted horizontally, usually the CCC is the one which is moved to make the perfect overlap. More overlap means more heat recovery because the overlap area shows how much heat is recuperated between hot and cold streams. As the CCC shifts towards HCC more overlap is achieved and smaller temperature difference between curves until we get to the lower bound which is determined by minimum temperature difference. Beyond that point, no further overlap is possible, and the closest approach between the curves is called the Pinch point. The pinch point and joined composite curves are showed in Figure 2.

There are three basic rules in determining the pinch point which prevent an increase in energy utility demands. The pinch divides the heat recovery problem into a heat sink above the pinch and heat source below it. At the pinch point, where the temperature difference is minimum, the streams are not allowed to exchange heat. Because of that the heat sink above the pinch is in balance with the minimum hot utility and the heat source below the pinch is in balance with the minimum cold utility. Also no heat can be transferred from below to above the pinch because it is thermodynamically infeasible and although the version where the hot stream above the pinch exchange heat with streams below the pinch is thermodynamically feasible, applying it would cause utility use to exceed the minimum. If the heat is transferred across the pinch, then the hot and cold utility demands will increase by the same amount in order to maintain the heat ballances. All of these conditions can be distilled into the following three conditions:

1. Heat must not be transferred across the Pinch
2. There must be no external cooling above the Pinch
3. There must be no external heating below the Pinch.

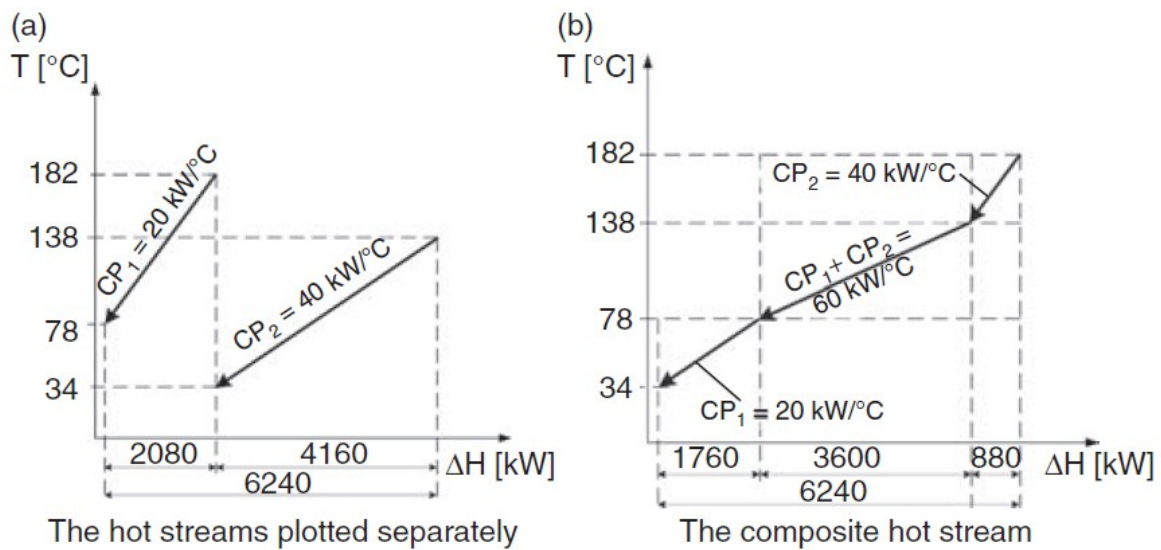

Figure 1 The construction of hot composite curve [1]

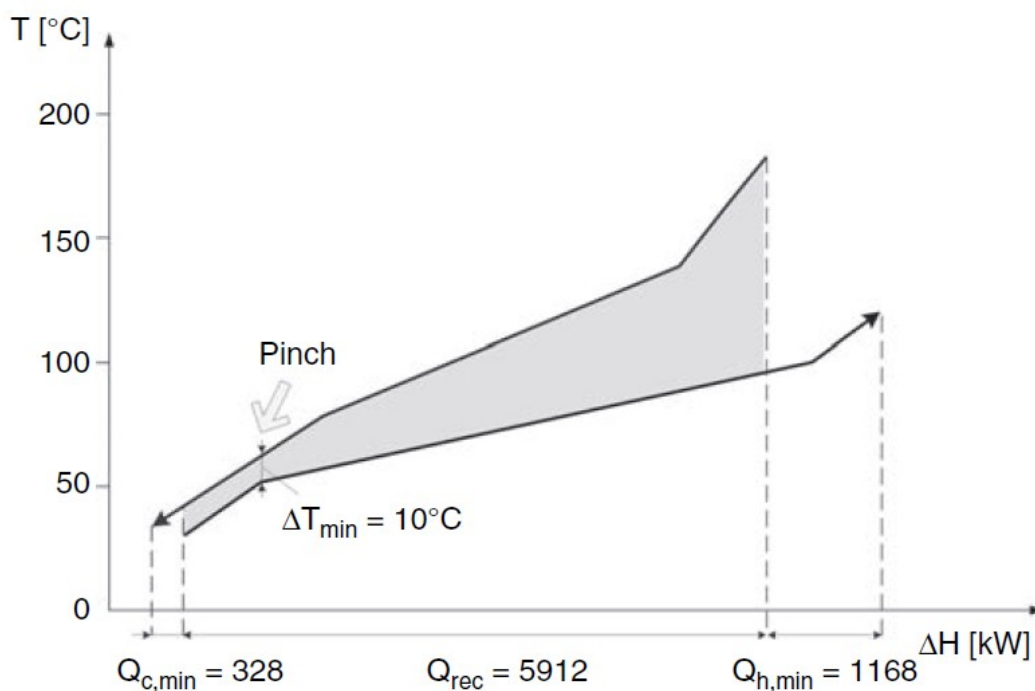

Figure 2 Pinch point for $\Delta T_{\min} = 10^\circ\text{C}$ [1]

2.3. Numerical targeting: the problem table algorithm

Solely when targeting composite curves graphically, the results are often not as accurate as they should be and the process is time consuming. Fortunately, numerical target gives us a way to calculate the curves via the problem table algorithm. After the calculation it is easy to use the information to make graphical abstract. Problem Table Algorithm (PTA) is an

algorithm with five steps for determining the composite curves and the capacity of hot and cold utility. [1]

Steps:

1. Shift the process stream temperatures.
2. Set up temperature interval.
3. Calculate interval heat balances.
4. Assuming zero hot utility, cascade the balances as heat flows.
5. Ensure positive heat flows by increasing the hot utility as needed.

Step 1

PTA uses temperature intervals, so it's necessary to set up a unified temperature scale for the calculations. When using the real steam temperature, some of the heat content would be left out of recovery. To avoid it, it is needed to shift the hot streams temperature to be colder by $\Delta T_{min}/2$, and cold streams to be hotter by $\Delta T_{min}/2$. That way if the new shifted temperatures of the hot and cold streams are the same, they are in reality still apart by ΔT_{min} (Figure 3).

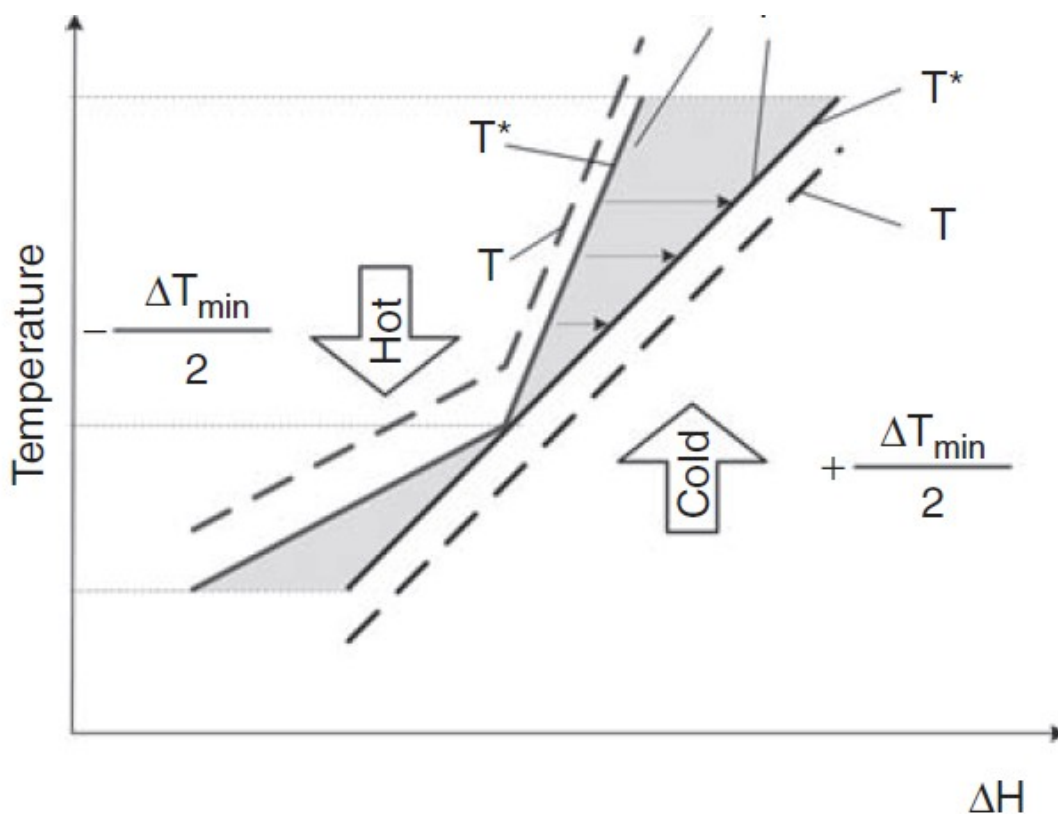

Figure 3 Shifting temperature [1]

Step 2

Next step is to create temperature boundaries, which form temperature intervals. It is done by putting all the shifted TT and TS in descending order.

Step 3

The ΔT of the interval should be multiplied with the sum of the segments heat capacity flow rates (CPs). That way the interval heat balance is calculated.

Step 4

The Problem Heat Cascade is made by the assumption of zero hot utility. As shown in Table 1, each temperature interval has the appropriate column which contains the interval enthalpy balances calculated on Step 3. At the columns next to the interval enthalpy balance, starting by summing zero at the first enthalpy interval at the first temperature interval the enthalpy balances are summed as we are descending on the interval. The result will be like the cascade shown in the table 1.

[°C]		T Interval	H Interval	Cascade
126		0	-261,10	-261,10
125	126*	10	-5,44	-266,54
115		10	7,63	-258,91
105		0	265,90	6,99
105		20	25	31,99
85		25	239,375	271,365
60		1	-7,885	263,48
59		0	183,40	446,88
59		14	-110,39	336,49
45		10	-73,41	263,08
35		12	-209,52	53,56
23				

Table 1 The Problem Heat Cascade

*these two temperatures are here because there is no stream in the interval between 125°C and 126°C in this specific example. Also where interval is 0 means there is a stream with phase changing.

Step 5

From the cascade, the smallest value should be identified. If the value is nonnegative, then the heat cascade is thermodynamically feasible. If a negative value is obtained then a positive utility flow of the same absolute value has to be provided at the topmost heat flow, after which cascading described in Step 4 is repeated. The resulted heat cascade is feasible and it presents the numerical heat recovery targets. The top value presents minimum hot utility and the bottom value presents minimum cold utility. The temperature interval with 0 on the cascade presents the pinch point, as shown in the table 2. [1]

[°C]	T Interval	H Interval	Cascade	kW		
126						
125	126*	0	-261,10	-261,10	266,54	Min heat utility
115	10	-5,44	-266,54	5,44		
105	10	7,63	-258,91	0,00	Pinch = 115°C	Hot Pinch 120°C
105	0	265,90	6,99	7,63		Cold Pinch 110°C
85	20	25	31,99	273,53		
60	25	239,375	271,365	298,53		
59	1	-7,885	263,48	537,91		
59	0	183,40	446,88	530,02		
45	14	-110,39	336,49	713,42		
35	10	-73,41	263,08	603,03		
23	12	-209,52	53,56	529,62		
				320,1	Min cold Utility	

Table 2 Final cascade with Pinch point

2.3.1. Construction of the composite curves with PTA data

To get the real composite curves instead of shifted ones, we shift back the TT and TS for hot and cold streams. Next, the original temperatures for the streams should be put into the ascending order and remove any duplicate temperatures except ones which are duplicate because of the phase changing streams. This process should be made separately for hot and for cold streams. Next to the stream boundary temperatures, the appropriate enthalpies from the cascade should be put next to each temperature boundary. The first temperature of the CCC should be paired with the minimum cold utility, and the first temperature on the hot composite curve should be paired with zero. When we know the initial enthalpy of the cold and hot composite curves it is only needed to construct them as explained in chapter 2.2.2.

2.3.2. Construction of Grand Composite Curve (GCC)

The Grand Composite Curve (GCC) is a graphical construction useful for choosing the hot and cold utilities and to evaluate the cheapest and most effective combination of the

available utilities. Also it is needed for Total site recovery calculations which will be made later in the thesis.

Construction

The construction is made using Problem Heat Cascade (Figure 6). The heat flow is plotted on T-ΔH diagram, where the heat flow for each temperature boundary corresponds to the X coordinate and the temperature to the Y coordinate. It can also be related to Shifted Composite Curves (SCCs), which are the result of shifting the CCs toward each other (See chapter 2,3.) so that curves touch each other at the Pinch. The parts with positive slope indicate that the cold streams dominate, and with the negative slope indicate that the hot streams dominate. At the Figure 4 we can see shaded areas which indicate heat recovery pockets. These places define opportunities for process to process heat recovery. Later in the total site profiles, the usage of intermediate utility will make the heat recovery pockets. [1]

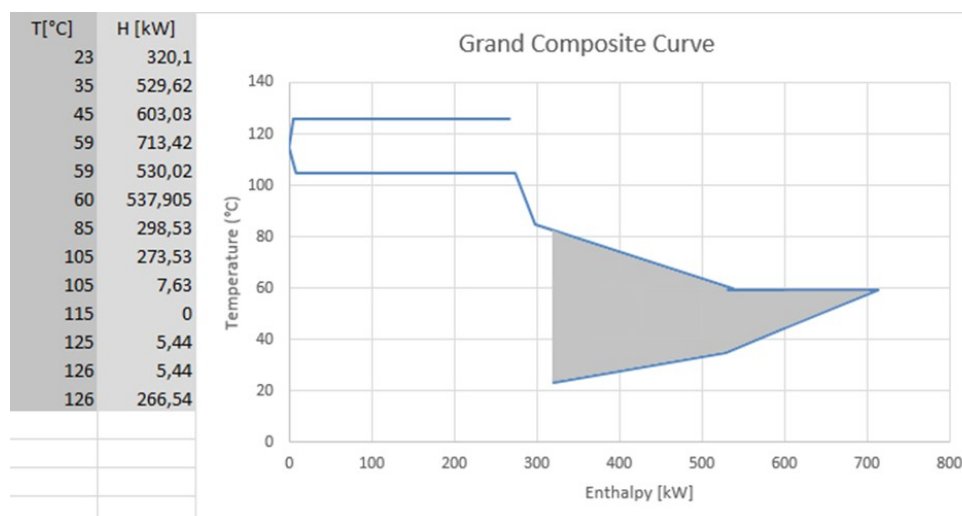

Figure 4 Grand composite curve

2.4. Total Site Profile (TSP)

Total site profiles (TSPs) are constructed using GCCs from each process, as said before. TSPs are thermal profiles for the entire site. In the beginning, extraction of heating and cooling demand on GCCs is needed. Excluding the recovery pockets will be the necessary option for the extraction. The remaining curve parts represent the net demands of heat source and sink. Also, the horizontal rotation of heat source segments is needed. Finally, the thermal combination of stream segments (as in the construction of CCs), and alignment of the resulting Total Site sink and Total Site source profile has to be included. Also, bear in mind that the sink and source profile temperatures are shifted, so if they touch each other, there is still enough driving force to transfer heat between them. Since we are using an intermediate utility, the temperatures have to be shifted even more, so that each heat sink and heat source temperature is shifted for $2\Delta T_{min}$ apart from each other at the end. Steps also shown graphically in figure 5.

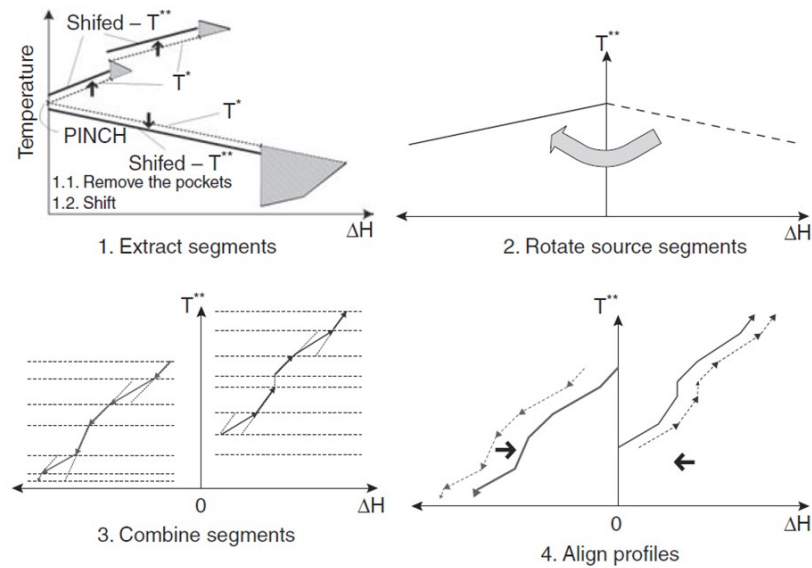

Figure 5 Construction of the TSP [1]

2.4.1. Finding the Pinch on TSPs

After construction of TSPs, finding the Pinch is achieved by moving Site Source profile along the X axis by summing all Enthalpy values with the amount which is just right so that at one temperature enthalpy is the same for the sink and source profile (See Figure 6). It can also be achieved the same way as described in 2.3. for Composite Curves, which would be more precise.

After joining profiles, the temperatures can be shifted back to the real values.

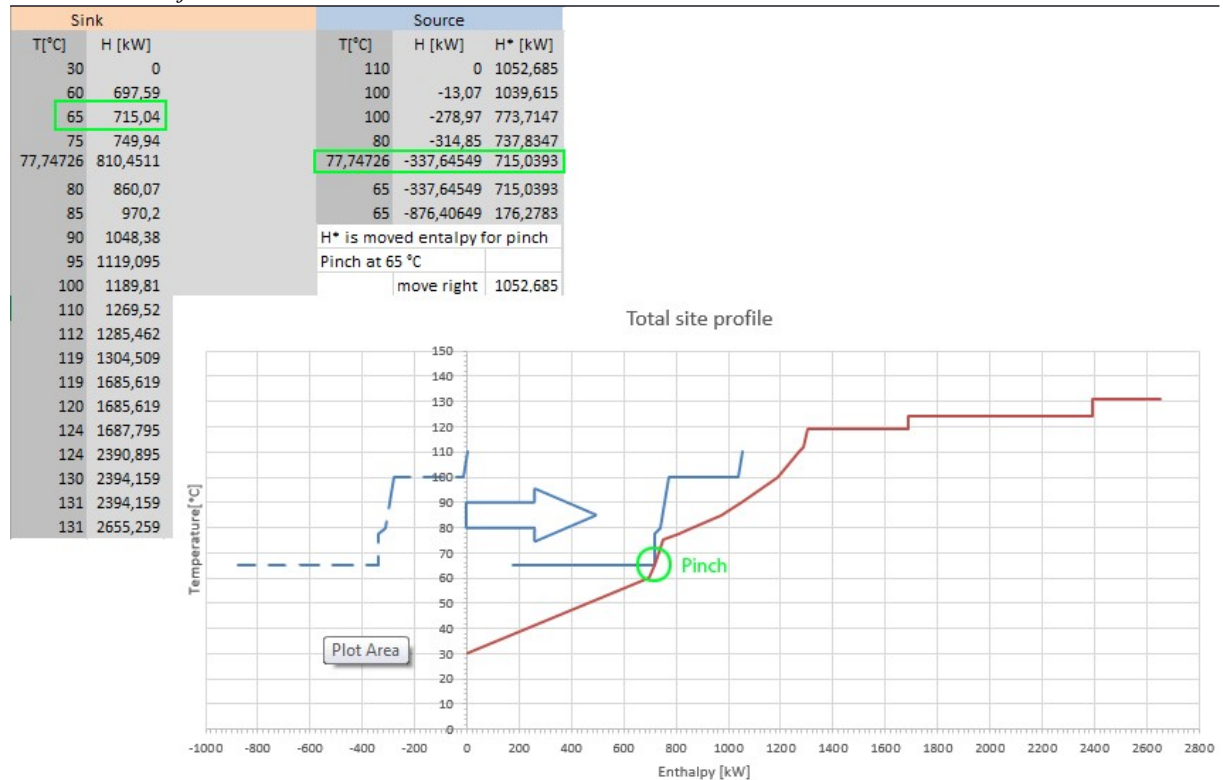

Figure 6 Finding the Pinch on TSP

2.5. Heat transfer area

Heat exchanger network (HEN) capital cost depends on the heat transfer area, the number of heat exchangers, the number of shell and tube passes in each heat exchanger, construction materials, equipment type and operating procedures. The heat transfer area is the most significant factor which in this case will decide the temperatures of the intermediate utility on Total Site. Although the heat transfer area in single process is implicitly determined by minimum temperature difference, it is also calculated for the purposes of economic analysis.

2.5.1. Single site heat transfer area [1]

The minimum heat transfer area target can be obtained by estimating it within each enthalpy interval of the CCs and then summing up the values over all intervals. The enthalpy interval is a slice constrained by two vertical lines with fixed values on the enthalpy axis (Figure 7). The interval is chosen that during each interval CCs have constant slope. After determining enthalpy intervals, using equation (1), the minimum heat transfer area can be calculated.

$$A_{HEN, min} = \sum_{i=1}^{EI} \left(\frac{1}{\Delta T_{LM,i}} \sum_{s=1}^{NS} \frac{q_{s,i}}{h_{s,i}} \right) \quad (1)$$

REF_{Ref 287447026}

"EI" and "NS" denote the number of enthalpy intervals and the number of streams. "i" denotes the number of enthalpy interval and "s" denotes the sth stream. The " $\Delta T_{LM,i}$ " denotes the logarithmic temperature difference in interval "i". " $q_{s,i}$ " denotes the enthalpy change of the sth stream and " $h_{s,i}$ " denotes the heat transfer coefficient of the sth stream.

$$\Delta T_{LM} = \frac{\Delta T_{eis} - \Delta T_{eie}}{\log \left(\frac{\Delta T_{eis}}{\Delta T_{eie}} \right)} \quad (2)$$

ΔT_{eis} and ΔT_{eie} are the temperature difference of hot and cold stream on the beginning of the enthalpy interval and on the end of the interval.

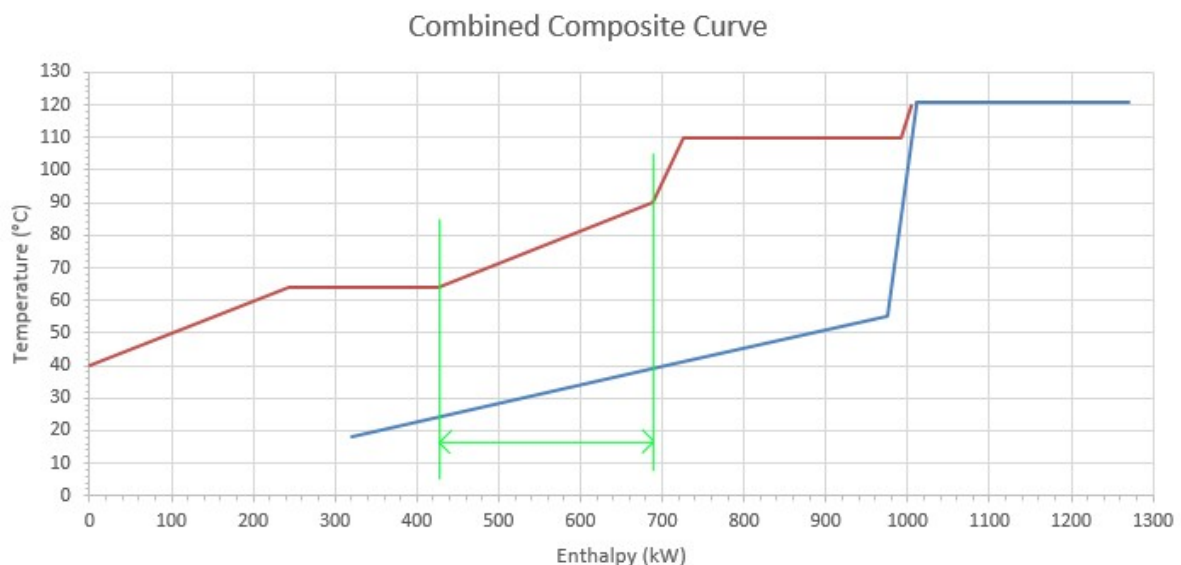

Figure 7 Example of one enthalpy interval

2.5.2. Total site heat transfer area and intermediate utility

The calculation of heat transfer area is absolutely the same as in single sites. The only difference is that the heat transfer area is a variable of intermediate utility temperature. That is why it is important to calculate heat transfer area for few different intermediate utility temperatures and choose the minimum area between them.

2.6. Heat exchanger network (HEN) synthesis

Method used in HEN synthesis is The Pinch Design Method which became popular owing to its simplicity and efficient management of complexity. The convenient and efficient representation of HENs is the grid diagram. It has clear representation of temperatures and the Pinch location is clearly visible. Grid diagram represents only heat transfer operations. The temperature is ascending from left to right, which is intuitive and in line with CC diagrams. Simple representation of grid diagram shown in figure 8.

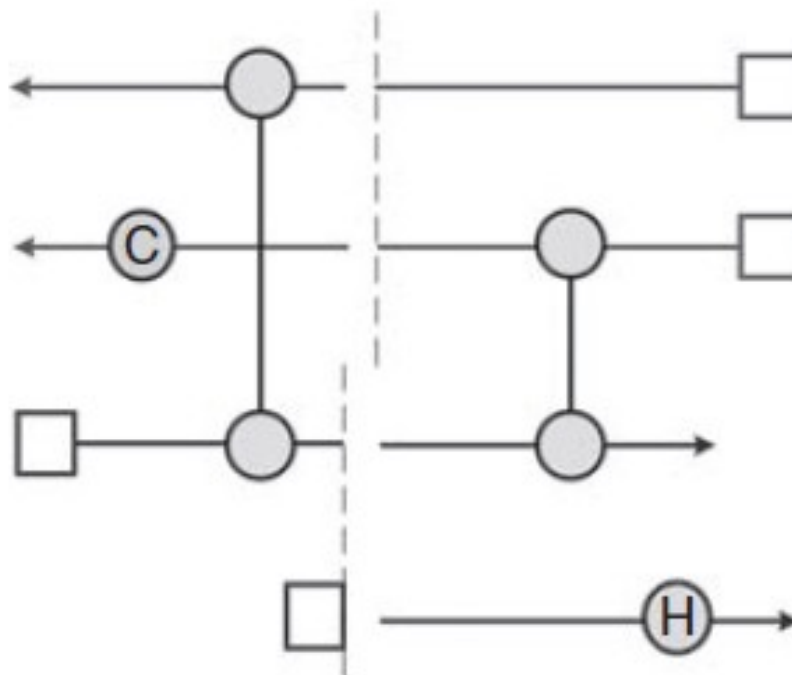

Figure 8 Simple representation of HEN grid diagram [1]

2.6.1. The design procedure of HEN grid diagram [1]

It follows several steps:

1. Specification of the heat recovery problem
2. Identification of the heat recovery targets and the heat recovery Pinch.

3. Synthesis
4. Evolution of the HEN topology

The first two steps were explained in previous sections. The Synthesis starts by dividing the problem at the Pinch and then positioning the process streams. The engineering practice suggests starting the network design from the Pinch (the most restricted part of the design owing to temperature differences approaching ΔT_{\min}) and then to place heat exchanger matches while moving away from the Pinch. When placing matches, several rules have to be followed

in order to obtain a network that minimizes utility use:

1. No exchanger may have a temperature difference smaller than ΔT_{\min}
2. No process to process heat transfer may occur across the Pinch
3. No inappropriate use of utilities should occur.

At the Pinch, the enthalpy balance restrictions entail that certain matches must be made if the design is to achieve minimum utility usage without violating the ΔT_{\min} constraint; these are referred to as *essential* matches. Above the Pinch, the hot streams should be cooled only by transferring heat to cold process streams, not to utility cooling. Therefore, all hot streams above the Pinch have to be matched up with cold streams. This means that all hot streams entering the Pinch must be given priority when matches are made above the Pinch. Conversely, cold streams entering the Pinch are given priority when matches are made below the Pinch.

3. CASE STUDY CALCULATIONS AND GRAPHICAL ABSTRACT

3.1. Initial data

Table 3 shows the initial data for process streams which were given by mentor.

Process A – industrial						
Stream	Type	TS (°C)	TT (°C)	CP (kW/°C)	ΔH (kW)	<i>h</i> (kW/(m ² C))
Stream 1 cooling	Hot	90	40	8.325	416.3	1.2
Stream 2 condensation	Hot	64	64	185*	183.4	5.3
Stream 3 condensation	Hot	110	110	2296*	265.9	6.2
Stream 4 cooling	Hot	120	40	1.307	104.5	1.0
Stream 5 cooling	Hot	110	40	0.487	34.1	1.0
Stream 6 heating	Cold	18	55	17.460	646.0	1.0
Stream 7 heating	Cold	40	120	0.544	43.6	1.2
Stream 8 evaporation	Cold	121	121	2254*	261.1	5.5

* – latent heat of phase change

Process B – industrial						
Stream	Type	TS (°C)	TT (°C)	CP (kW/°C)	ΔH (kW)	<i>h</i> (kW/(m ² C))
Stream 1 cooling	hot	60	55	9.312	46.56	0.8
Stream 2 condensation	hot	90	60	2.682	80.45	0.8
Stream 3 condensation	hot	61	61	2355*	369.40	6.0
Stream 4 condensation	hot	75	75	2336*	725.50	6.0
Stream 5 condensation	hot	95	75	2.654	53.08	1.2
Stream 6 evaporation	cold	109	109	2264*	381.11	6.0
Stream 7 evaporation	cold	114	114	2141*	703.10	6.0
Stream 8 heating	cold	55	90	2.682	93.86	0.8
Stream 9 heating	cold	60	109	2.721	133.30	0.8
Stream 10 heating	cold	50	80	1.493	44.80	1.0
Stream 11 heating	cold	20	36	18.620	298.00	1.0
Stream 12 heating	cold	45	75	11.640	349.20	1.3
Stream 13 heating	cold	75	102	5.250	141.80	1.4

* – latent heat of phase change

Process C – residential and commercial area						
Stream	Type	TS (°C)	TT (°C)	CP (kW/°C)	ΔH (kW)	<i>h</i> (kW/(m ² C))
Heating of power substation	cold	50	90	3.490	139.6	1.0
Hot water of residential area	cold	20	50	16.296	488.9	1.0
Hot water of commercial area	cold	20	50	6.984	209.5	1.0

Table 3 Initial data

In addition, the data for economic analysis:

- Price of hot utility is 366 EUR/kWy (prices of natural gas 0.042 EUR/kWh)
- Price cold utility is 36 EUR/kWy
- Specific price of heat transfer area is 800 EUR/m²
- Installation costs with revamp of 1 heat exchanger are 10,000 EUR
- The coefficient of nonlinearity of heat transfer area price is 0.87
- Plant life is 5 year
- Return on investment employed of 10%.

3.2. Industrial process A

Firstly, the data was put in the excel table, and the temperatures were shifted according to Step 1 in section 2.3 (See Table 4).

							SHIFTED temperatures		
		TS [°C]	TT [°C]	CP [kW/°C]	dH [kW]	h [kW]	TS [°C]	TT [°C]	
Hot	S4	120,00	40,00	1,31	104,50	1,00	S4	115,00	35,00
Hot	S3	110,00	110,00	2296,00	265,90	6,20	S3	105,00	105,00
Hot	S5	110,00	40,00	0,49	34,10	1,00	S5	105,00	35,00
Hot	S1	90,00	40,00	8,33	416,30	1,20	S1	85,00	35,00
Hot	S2	64,00	64,00	185,00	183,40	5,30	S2	59,00	59,00
Cold	S8	121,00	121,00	2254,00	-261,10	5,50	S8	126,00	126,00
Cold	S7	40,00	120,00	0,54	-43,60	1,20	S7	45,00	125,00
Cold	S6	18,00	55,00	17,46	-646,00	1,00	S6	23,00	60,00

dTmin [°C]	10
------------	----

Table 4 Data table (Process A)

For easier multiplication of certain CPs (See chapter 2.3.) the table of streams has been made. The table in figure 9 shows which streams are in which interval.

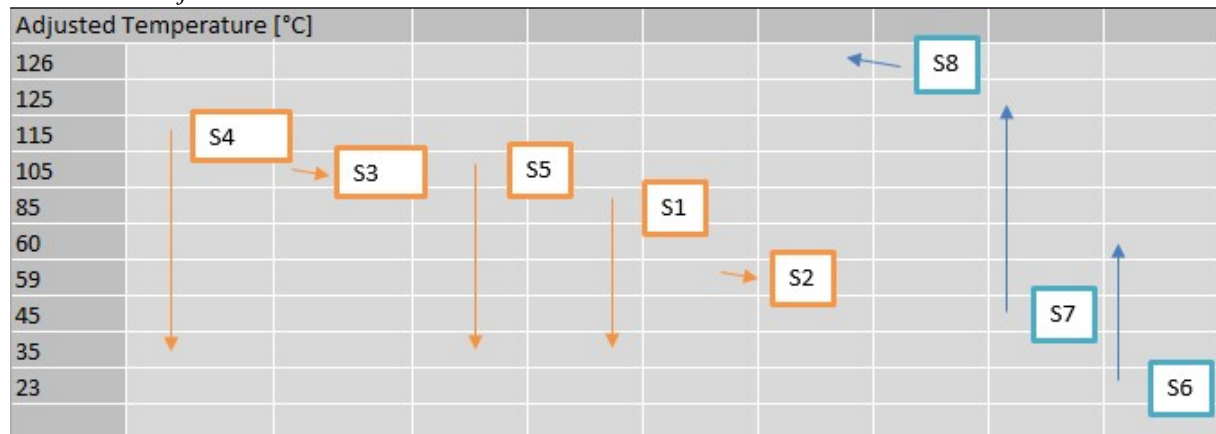

Figure 9 The table of streams

T Interval [°C]	H Interval [kW]		kW	
0	-261,10	Cascade	266,54	Min hot utility
10	-5,44		5,44	
10	7,63		0,00	Pinch = 115°C
0	265,90		7,63	Cold Pinch 110°C
20	25		273,53	
25	239,375		298,53	
1	-7,885		537,91	
0	183,40		530,02	
14	-110,39		713,42	
10	-73,41		603,03	
12	-209,52		529,62	
			320,1	Min cold Utility
			1004,20	Recovery

Table 5 The Problem Heat Cascade (Process A)

The problem heat cascade is made as explained in chapter 2.3 (Table 5). In addition, CCC and HCC are composed as explained in 2.3.1. and 2.3.2. The CCC is shown in figure 10, and HCC in figure 11.

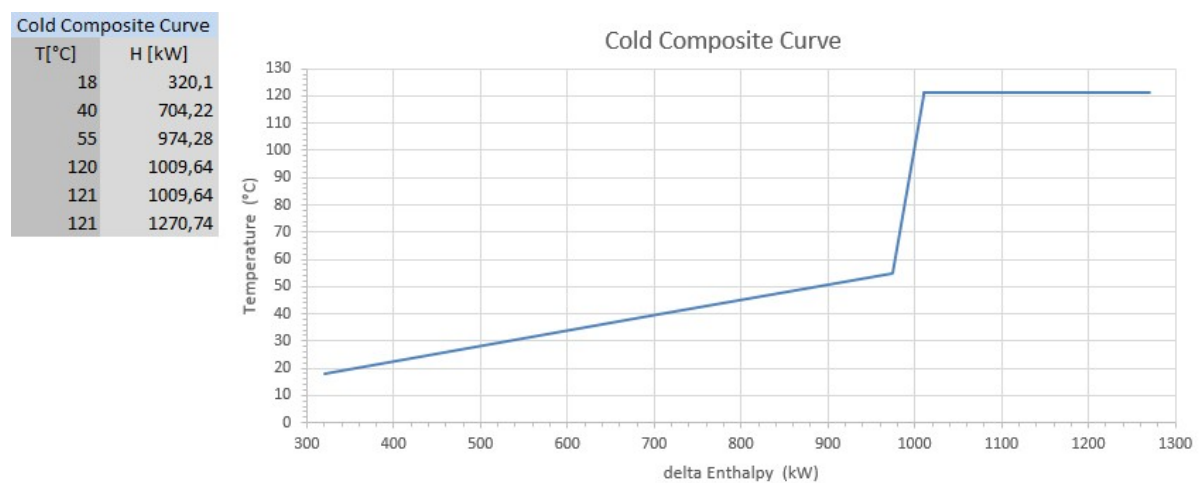

Figure 10 Cold Composite Curve (Process A)

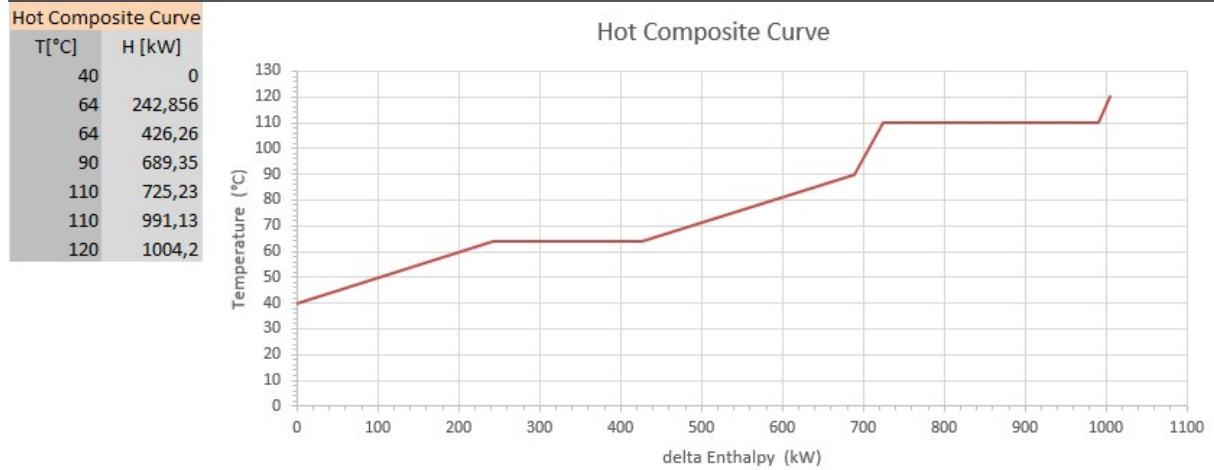

Figure 11 Hot Composite Curve (Process A)

The combined composite curves in figure 12 clearly shows the Pinch point and minimum cold and minimum hot utility for Process A. Also, the part where curves have the same enthalpy are in recovery.

Pinch (°C)	Min. Cold (kW)	Min. Hot (kW)
115	320,1	266,54

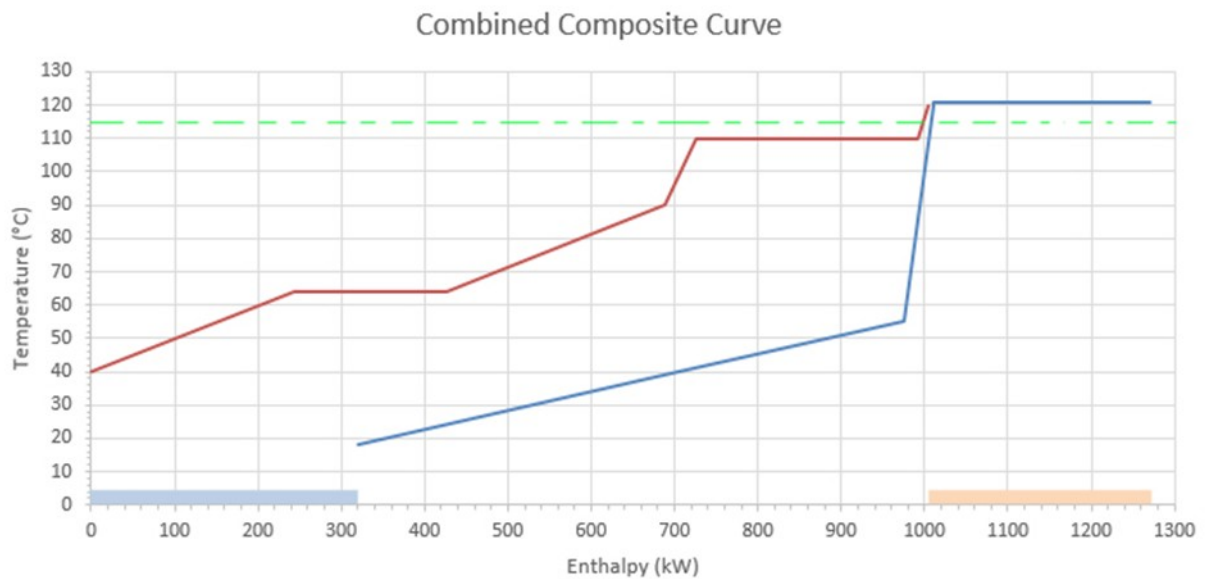

Figure 12 Combined Composite Curves (Process A)

Furthermore, the GCC graphical abstract constructed as explained in 2.3.2.. shows recovery pockets and the sufficite which is regenerated via intermediate utility in total site.

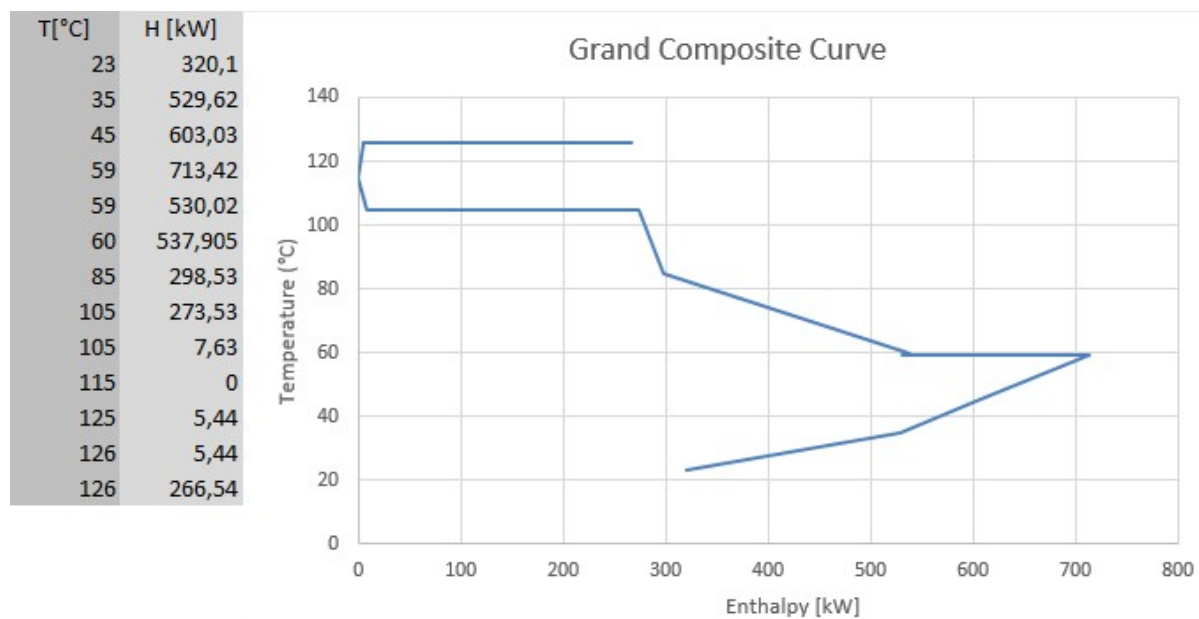

Figure 13 Grand Composite Curve (Process A)

The calculation for HEN area in process A (Table 6) is as explained in 2.5.1. The surface is calculated using equation (1). "Ths" is the temperature of hot streams in the beginning of the enthalpy interval. "The" is the end temperature of hot stream in the end of the enthalpy interval. "TcS" is the temperature of cold stream on the beginning of the interval, and "Tce" is the cold streams temperature at the end of the enthalpy interval. The enthalpy intervals have beginning at lower enthalpy number and end at bigger number. The logarithmic temperature difference (dT_{log}) is calculated as in equation (2). The HEN grid diagram is shown in Figure 14.

EI	H1 [kW]	H2 [kW]	Ths [°C]	The [°C]	Tcs [°C]	Tce [°C]	Streams	q [kW]	h [kW/m ² °C]	q/h [m ² °C]	dTa [°C]	dTb [°C]	dTlog [°C]	Amin [m ²]
1	320,1	426,26	64	64	18	24,08	s2	106,16	5,30	20,03	46	40	42,89	2,94
2	426,26	689,35	64	90	24,08	39,15	s1	106,16	1,00	106,16	40	51	45,17	10,85
							s4	33,98	1,00	33,98				
							s5	12,66	1,00	12,66				
3	689,35	725,23	90	110	39,15	41,17	s4	263,09	1,00	263,09	51	69	59,39	1,21
							s5	9,74	1,00	9,74				
							s6	35,25	1,00	35,25				
							s7	0,63	1,20	0,53				
4	725,23	974,28	110	110	41,17	55	s3	249,05	6,20	40,17	69	55	61,66	4,67
							s6	241,52	1,00	241,52				
							s7	7,53	1,20	6,27				
5	974,28	991,13	110	110	55	85,97	s3	16,85	6,20	2,72	55	24	37,40	0,45
							s7	16,85	1,20	14,04				
6	991,13	1004,2	110	120	85,97	110	s4	13,07	1,00	13,07	24	10	16,00	1,50
							s7	13,07	1,20	10,89				
														Ahen,a [m²]
														21,62

Table 6 The calculation of the heat transfer area of HEN (Process A)

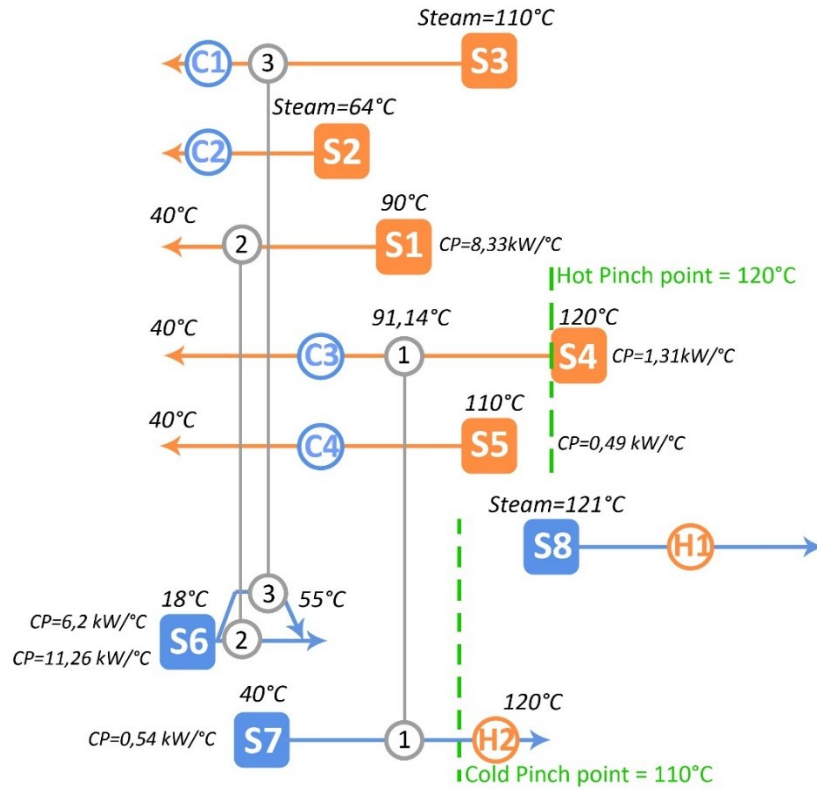

Figure 14 HEN grid diagram (Process A)

$$CP_{s6,1} = \frac{(T_{s1s} - T_{s1t}) \cdot CP_{s1}}{(T_{s6t} - T_{s6s})} = \frac{(90 - 40) \cdot 8,33}{55 - 18} = 11,2568 \frac{kW}{^{\circ}C} \quad (3)$$

$$CP_{s6,2} = CP_{s6} - CP_{s6,1} = 17,46 - 11,2568 = 6,2032 \frac{kW}{^{\circ}C} \quad (4)$$

$$Q_{HE1} = (T_{cpp} - T_{s7s}) \cdot CP_{s7} = (110 - 40) \cdot 0,54 = 37,8 kW \quad (5)$$

$$Q_{HE2} = (T_{s6t} - T_{s6s}) \cdot CP_{s6,1} = (55 - 18) \cdot 11,2568 = 416,5 kW \quad (6)$$

$$Q_{HE3} = (T_{s6t} - T_{s6s}) \cdot CP_{s6,2} = (55 - 18) \cdot 6,2032 = 229,52 kW \quad (7)$$

$$C_1 = \Delta H_{s3} - Q_{HE3} = 265,9 - 229,52 = 36,38 kW \quad (8)$$

$$C_2 = \Delta H_{s_2} = 183,4 \text{ kW} \quad (9)$$

$$C_3 = \Delta H_{s_4} - Q_{HE1} = 104,5 - 37,8 = 66,7 \text{ kW} \quad (10)$$

$$C_4 = \Delta H_{s_5} = 34,1 \text{ kW} \quad (11)$$

$$Q_{CU} = C_1 + C_2 + C_3 + C_4 = 36,38 + 183,4 + 66,7 + 34,1 = 320,58 \text{ kW} \quad (12)$$

$$H_1 = \Delta H_{s_8} = 261,1 \text{ kW} \quad (13)$$

$$H_2 = (T_{s_{7t}} - T_{cpp}) \cdot CP_{s_7} = (120 - 110) \cdot 0,54 = 5,4 \text{ kW} \quad (14)$$

$$Q_{HU} = H_1 + H_2 = 261,1 + 5,4 = 266,5 \text{ kW} \quad (15)$$

3.3. Industrial process B

All calculations for industrial process B are exactly the same as in industrial process A. Table 7 shows data table, figure 15 the table of streams, table 8 the problem heat cascade, figure 16 cold composite curve, figure 17 hot composite curve, figure 18 combined composite curve, figure 19 shows grand composite curve, table 9 shows the calculations for HEN surfaces, and figure 20 shows the HEN grid diagram.

		TS [°C]	TT [°C]	CP [kW/°C]	dH [kW]	h [kW]		TS [°C]	TT [°C]
Hot	S5	95,00	75,00	2,65	53,08	1,20	S5	90,00	70,00
Hot	S2	90,00	60,00	2,68	80,45	0,80	S2	85,00	55,00
Hot	S4	75,00	75,00	2336,00	725,50	6,00	S4	70,00	70,00
Hot	S3	61,00	61,00	2355,00	369,40	6,00	S3	56,00	56,00
Hot	S1	60,00	55,00	9,31	46,56	0,80	S1	55,00	50,00
Cold	S7	114,00	114,00	2141,00	703,10	6,00	S7	119,00	119,00
Cold	S6	109,00	109,00	2264,00	381,11	6,00	S6	114,00	114,00
Cold	S13	75,00	102,00	5,25	141,80	1,40	S13	80,00	107,00
Cold	S9	60,00	109,00	2,72	133,30	0,80	S9	65,00	114,00
Cold	S8	55,00	90,00	2,68	93,86	0,80	S8	60,00	95,00
Cold	S10	50,00	80,00	1,49	44,80	1,00	S10	55,00	85,00
Cold	S12	45,00	75,00	11,64	349,20	1,30	S12	50,00	80,00
Cold	S11	20,00	36,00	18,62	298,00	1,00	S11	25,00	41,00

dTmin [°C] 10

Table 7 Data table (process B)



Figure 15 The table of streams (Process B)

T Interval [°C]	H Interval [kW]	kW	
0	-703,10	Cascade	1458,219
5	-381,11		755,12
7	-19,047		374,01
12	-95,65		354,96
5	-53,265		259,31
5	-39,995		206,05
5	-34,05		166,05
10	-132,00		132,00
0	725,50		0,00
5	-79,27		725,50
5	-65,665		646,23
4	-41,804		580,57
0	369,40		538,76
1	-10,451		908,16
5	-11,64		897,71
9	0		886,07
16	-297,92		886,07
			588,15

Min heat utility

Pinch = 70 Hot Pinch 75°C
Cold Pinch 65°C

Min cold Utility

Recovery 1275,00 kW

Table 8 The Problem Heat Cascade (Process B)

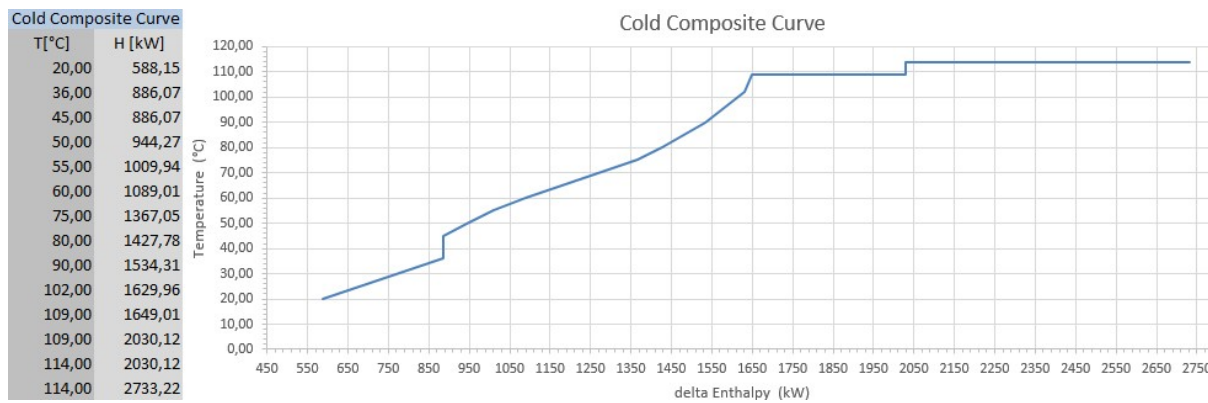

Figure 16 Cold Composite Curve (Process B)

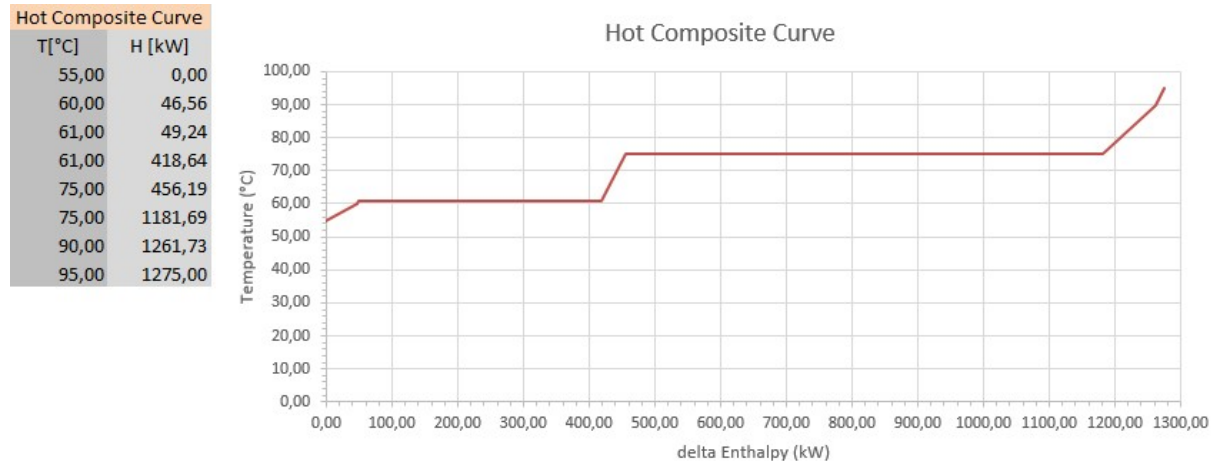

Figure 17 Hot Composite Curve (Process B)

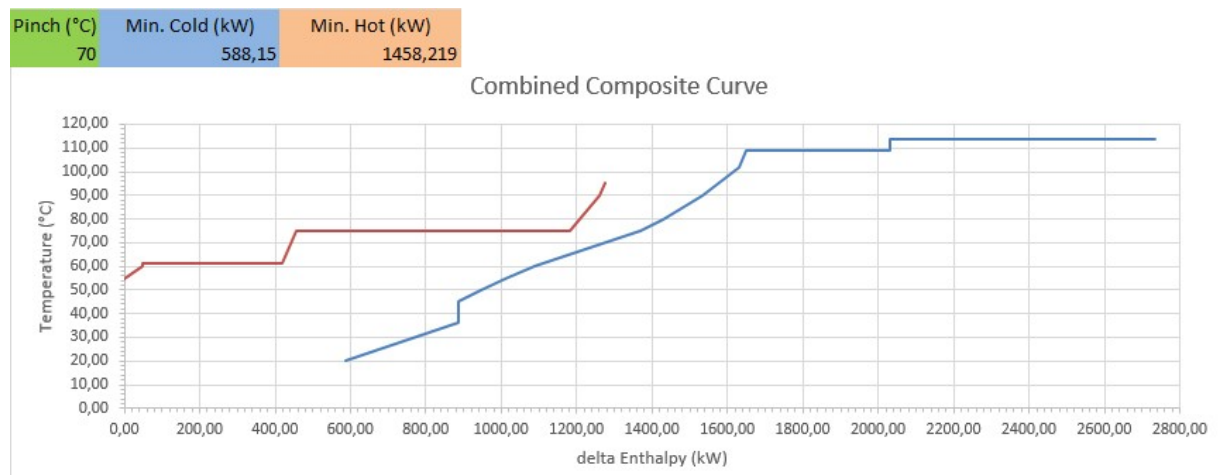

Figure 18 Combined Composite Curve (Process B)

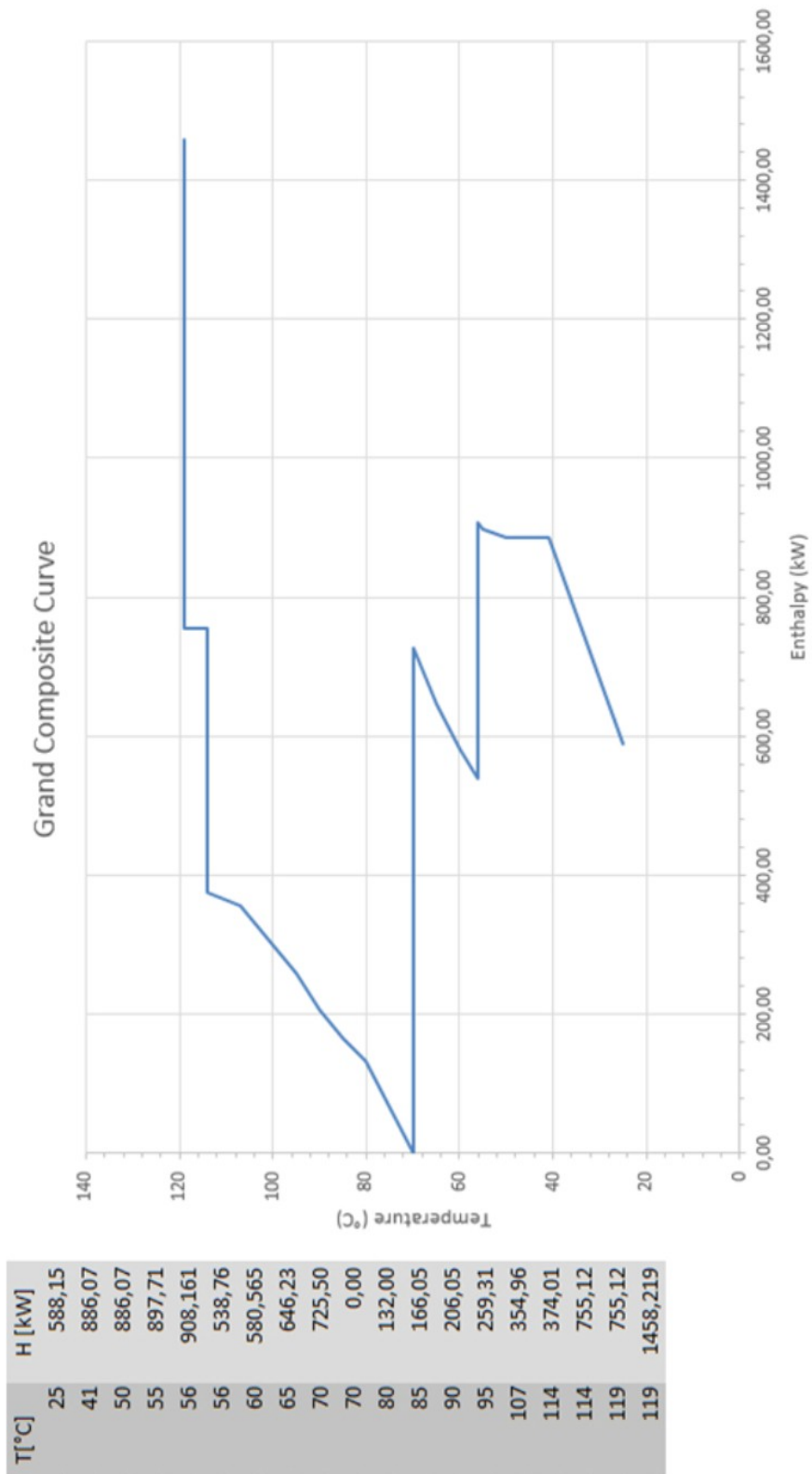

Figure 19 Grand Composite Curve (Process B)

EI	H1 [kW]	H2 [kW]	Ths [°C]	The [°C]	Tcs [°C]	Tce [°C]	Streams	q [kW]	h [kW/m ² °C]	q/h [m ² °C]	dTa [°C]	dTb [°C]	dTlog [°C]	Amin [m ²]
1	588,15	886,07	75	75	20	36	s4	297,92	6,00	49,65	55	39	46,54	7,47
2	886,07	944,27	75	75	36	50	s4	297,92	1,00	297,92	39	25	31,48	9,77
3	944,27	1009,935	75	75	50	55	s4	58,20	1,30	9,70	25	20	22,41	2,82
4	1009,935	1089,01	75	75	55	60	s4	65,67	6,00	10,94	20	15	17,38	4,73
5	1089,01	1181,69	75	75	60	65	s4	7,47	1,00	7,47	15	10	12,33	8,23
6	1181,69	1261,73	75	90	65	69,32	s5	58,20	1,30	44,77	10	20,68	14,70	10,73
7	1261,73	1275	90	95	69,32	70,03	s5	39,81	1,20	33,18	10	20,68	22,76	1,03
							s9	40,23	0,80	50,29				
							s9	11,75	0,80	14,69				
							s8	11,58	0,80	14,48				
							s10	6,45	1,00	6,45				
							s12	50,26	1,30	38,66				
							s9	13,27	1,20	11,06	20,68	24,97	22,76	1,03
							s8	1,95	0,80	2,43				
							s8	1,92	0,80	2,40				
							s10	1,07	1,00	1,07				
							s12	8,33	1,30	6,41				
														Ahen,a [m ²]
														44,77

Table 9 The calculation of the heat transfer area of HEN (Process B)

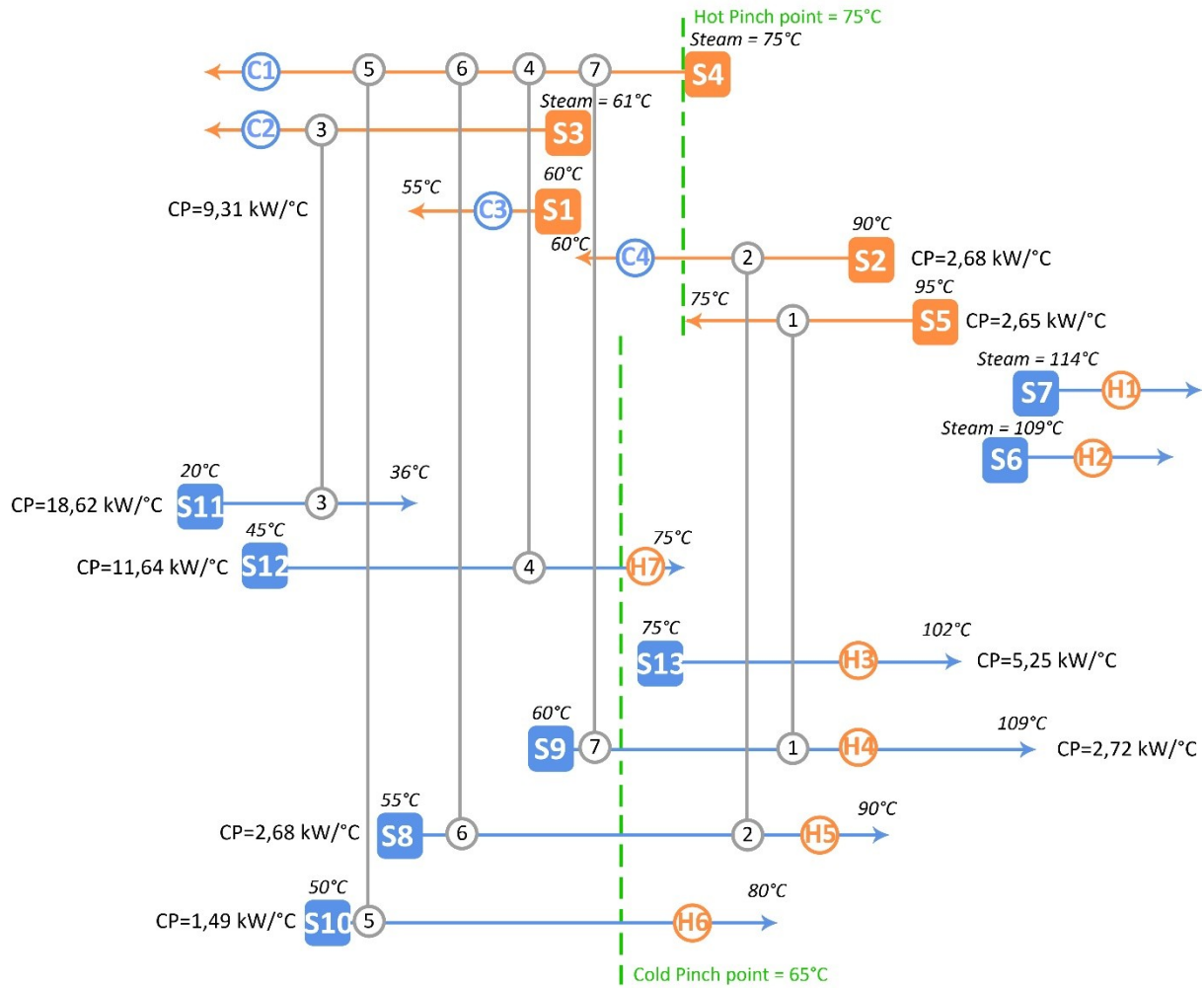

Figure 20 HEN network grid diagram (Process B)

$$Q_{HE1} = (T_{s5s} - T_{s5t}) \cdot CP_{s5} = (95 - 75) \cdot 2,65 = 53 \text{ kW} \quad (16)$$

$$Q_{HE2} = (T_{s2s} - T_{hpp}) \cdot CP_{s2} = (90 - 75) \cdot 2,68 = 40,2 \text{ kW} \quad (17)$$

$$Q_{HE3} = \Delta H_{s11} = 298 \text{ kW} \quad (18)$$

$$Q_{HE4} = (T_{cpp} - T_{s12s}) \cdot CP_{s12} = (65 - 45) \cdot 11,64 = 232,8 \text{ kW} \quad (19)$$

$$Q_{HE5} = (T_{cpp} - T_{s10s}) \cdot CP_{s10} = (65 - 50) \cdot 1,49 = 22,35 \text{ kW} \quad (20)$$

$$Q_{HE6} = (T_{cpp} - T_{s8s}) \cdot CP_{s8} = (65 - 55) \cdot 2,68 = 26,8 \text{ kW} \quad (21)$$

$$Q_{HE7} = (T_{cpp} - T_{s9s}) \cdot CP_{s9} = (65 - 60) \cdot 2,72 = 13,6 \text{ kW} \quad (22)$$

$$\Delta H_{s4} - (Q_{HE4} + Q_{HE5} + Q_{HE6} + Q_{HE7}) = 725,5 - (232,8 + 22,35 + 26,8 + 13,6) = 429,95 \text{ kW}$$

$$C_1 = 429,95 \text{ kW} \quad (23)$$

$$C_2 = \Delta H_{s3} - Q_{HE3} = 369,4 - 298 = 71,4 \text{ kW} \quad (24)$$

$$C_3 = \Delta H_{s1} = 46,56 \text{ kW} \quad (25)$$

$$C_4 = (T_{hpp} - T_{s2t}) \cdot CP_{s2} = (75 - 60) \cdot 2,68 = 40,2 \text{ kW} \quad (26)$$

$$Q_{CU} = C_1 + C_2 + C_3 + C_4 = 429,95 + 71,4 + 46,56 + 40,2 = 588 \text{ kW} \quad (27)$$

$$H_1 = \Delta H_{s7} = 703,1 \text{ kW} \quad (28)$$

$$H_2 = \Delta H_{s6} = 381,11 \text{ kW} \quad (29)$$

$$H_3 = \Delta H_{s13} = 141,8 \text{ kW} \quad (30)$$

$$H_4 = \Delta H_{s9} - Q_{HE1} - Q_{HE7} = 133,3 - 53 - 13,6 = 66,7 \text{ kW} \quad (31)$$

$$H_5 = \Delta H_{s8} - Q_{HE6} - Q_{HE2} = 93,86 - 26,8 - 40,2 = 26,86 \text{ kW} \quad (32)$$

$$H_6 = \Delta H_{s10} - Q_{HE5} = 44,8 - 22,35 = 22,45 \text{ kW} \quad (33)$$

$$H_7 = \Delta H_{s12} - Q_{HE4} = 349,2 - 232,8 = 116,4 \text{ kW} \quad (34)$$

$$Q_{HU} = H_1 + H_2 + H_3 + H_4 + H_5 + H_6 + H_7 = 703,1 + 381,11 + 141,8 + 66,7 + 26,86 + 22,45 + 116,4 = 1458,42 \text{ kW} \quad (35)$$

3.4. Process C – Residential and commercial area

		TS [°C]	TT [°C]	CP [kW/°C]	dH [kW]	h [kW]
Cold	S1	50,00	90,00	3,49	139,60	1,00
Cold	S2	20,00	50,00	16,27	488,90	1,00
Cold	S3	20,00	50,00	6,98	209,50	1,00

Table 10 Data table (Process C)

Everything calculated for Process C is explained in previous chapters. Table 10 shows the data table with process streams, figure 21 shows the table of streams for CP calculation and lastly, figure 22 shows cold composite curve.

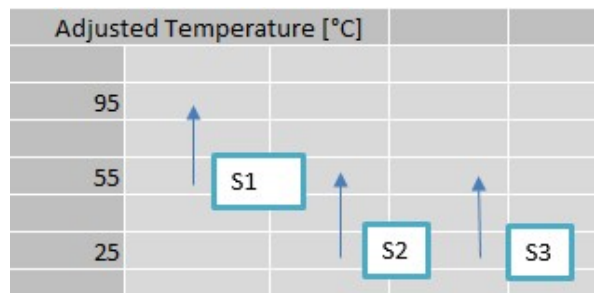

Figure 21 The table of streams (Process C)

Cold Composite Curve	
T [°C]	H [kW]
25	0
55	697,59
95	837,19

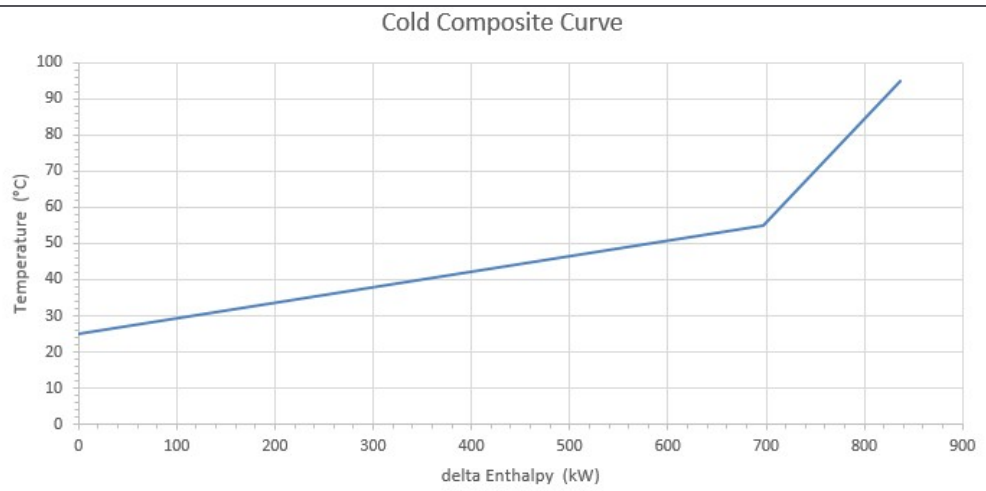

Figure 22 Cold Composite Curve (Process C)

3.5. Total site

The Total site data from table 11 is obtained from GCCs of each process. All streams outside of the recovery pockets are in Total site data. Streams with positive slope (streams going from left to right) are heat sinks and streams with negative slope (streams which go from right to left) are heat sources. Also, the temperatures are shifted as explained in 2.4.

Using the table 11, the table of streams for total site is made and shown in Figure 23. Multiple streams with same temperature intervals are joined and named Sink or Source XY where X is the Process and Y is the number of Sink or Source. That way it is easy to make sink or source profile. It is necessary to be careful with CPs of the streams, since the one Source or Sink profile is made out of multiple streams with different CPs. Total site stream profiles are made as explained in chapter 2.4.1. and shown in figure 24.

Table 12 shows the calculation of needed data for surface of heat exchangers for intermediate utility. There are 6 enthalpy intervals containing several streams each for heat sink and heat source. The start and end of each interval is determined with H1 and H2 in kW. Every time the new stream is included or an old one is excluded at some temperature, new enthalpy interval starts. "Tsa" is the temperature of source profile at the start of the interval, as well as the "Tsb" is the temperature of sink profile at the beginning of the interval. Similarly, the "Tsa" and "Tsb" are the temperatures at the end of the interval for sink and source profiles. "q" is the heat which has to be transferred from Source to intermediate utility and then from intermediate utility to sink profile for intermediate utility and separate streams in enthalpy interval. "h" is the coefficient of heat transfer of certain stream in kW per squared meters and degrees celsius. "hiu" is the coefficient of heat transfer of intermediate utility media which can be water or steam. Some enthalpy intervals were joined together because some intervals were transferring low amount of heat and it was reasonable to join them because joining or not joining them makes no or very small difference. In power of that, the temperature changes of each stream in intervals were calculated under "dTstream", so the exact "q" and "h" ratio for each stream is calculated. Also the ratio for intermediate utility is calculated. The number of heat exchangers depends on how many streams there are. Each stream needs separate heat exchanger, and the number of them is shown in Table 12.

Furthermore, the calculations of intermediate utility temperature and heat transfer surface were made in table 13 and 14. For each interval the calculations for several intermediate utility temperatures were made, and depending on the lowest possible surface, the temperature of utility was chosen. The equation for "dTlog" is (2) and for surfaces it is equation (1). The rest is explained in methodology description.

In Figure 25, the final profile of intermediate utility is shown. For hot utility the hot water steam is used as well as regular water at lower temperature. Also, the calculations of hot utility surfaces were calculated in table 15 using equation (1).

		Ts [°C]	Te [°C]	Tstart* [°C]	Tend* [°C]	Tstart** [°C]	Tend** [°C]	dH [kW]	CP [kW/°C]	streams
A	Sink A1	121	121	126	126	131	131	261,10		S8
	Sink A2	110	120	115	125	120	130	5,44	0,54	S7
	Source A1	120	110	115	105	110	100	7,63	1,31	s4
	Source A2	110	110	105	105	100	100	265,90		S3
	Source A3	110	90	105	85	100	80	25,00	1,79	s5+s4
	Source A4	90	88	85	83	80	78	21,57	10,12	S5+S4+S1
B	Sink B1	114	114	119	119	124	124	703,10		s7
	Sink B2	109	109	114	114	119	119	381,11		s6
	Sink B3	102	109	107	114	112	119	19,05	2,72	S9
	Sink B4	90	102	95	107	100	112	95,65	7,97	S13+S9
	Sink B5	85	90	90	95	95	100	53,27	10,65	S13+S9+S8
	Sink B6	80	85	85	90	90	95	40,00	10,65	S13+S9+S8
	Sink B7	75	80	80	85	85	90	34,05	12,15	S13+S9+S8+S10
	Sink B8	65	75	70	80	75	85	132,00	18,54	S9+S8+S10+S12
Source B1	75	75	70	70	65	65	538,76		s4	
C	Sink C1	50	90	55	95	60	100	139,60	3,49	Sc1
	Sink C2	20	50	25	55	30	60	697,59	23,28	Sc2+Sc3

Tstart* temperature moved by 5°C from Ts
 Tstart** temperature moved by 10°C from Ts

Table 11 Total site data

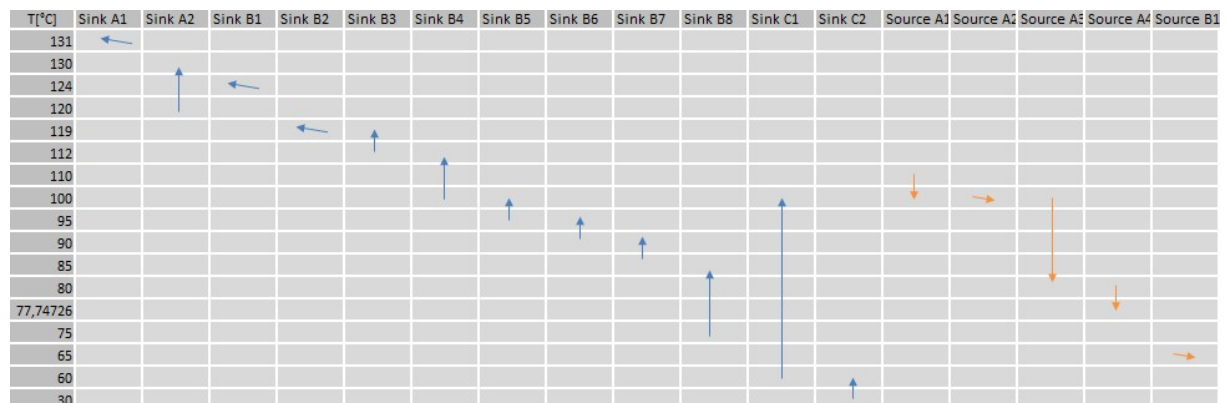

Figure 23 The table of streams for total site

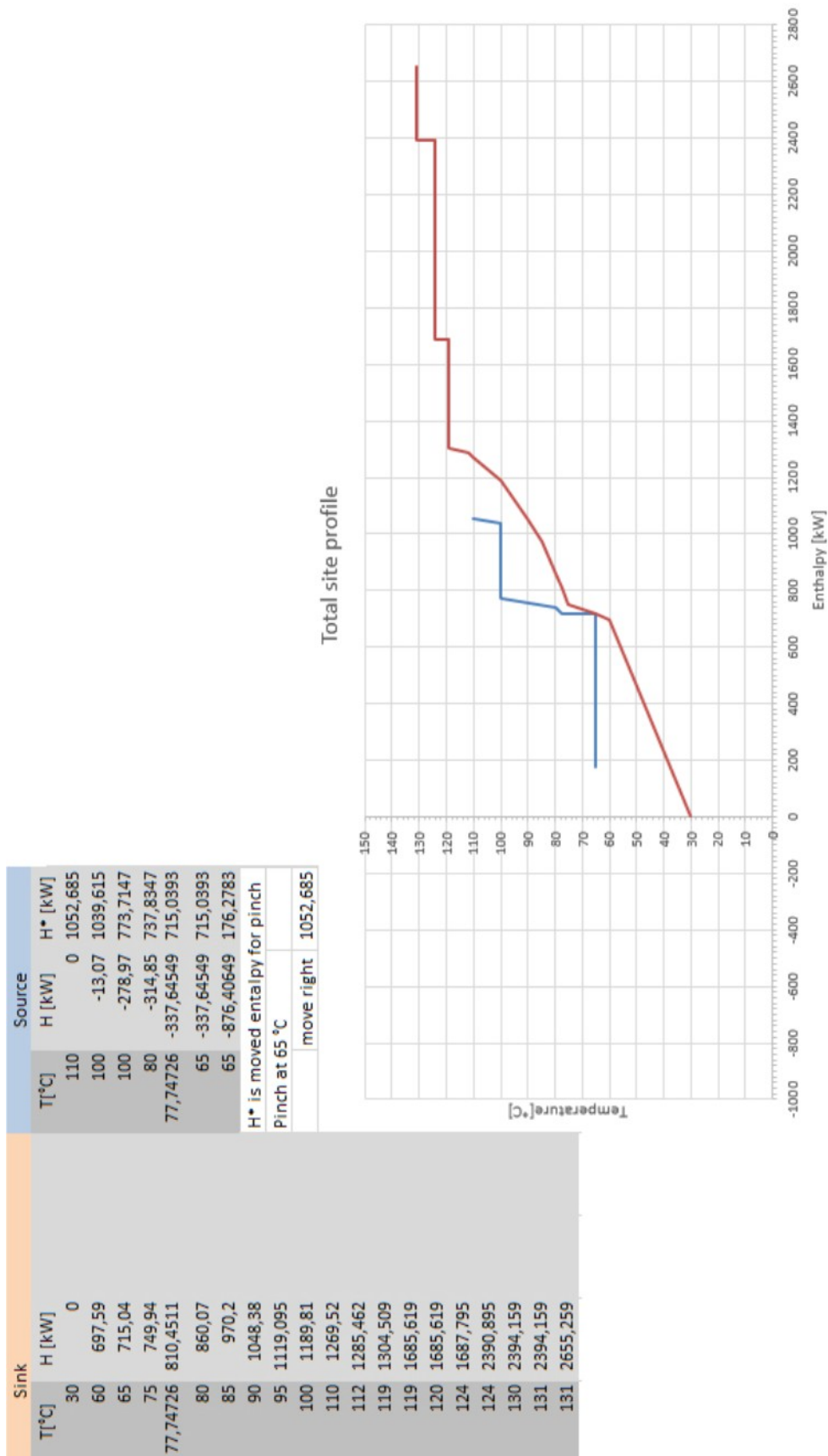

Figure 24 Total site stream profiles

EI	H1 [kW]	H2 [kW]	Tsa [°C]	Tea [°C]	Tsb [°C]	Teb [°C]	q [kW]	Streams a	h [kW/m²°C]	cp [kW/°C]	q/h [m²°C]	Streams b	h [kW/m²°C]	cp [kW/°C]	dTstream [°C]	q [kW]	q/h [m²°C]	q/h _{iu} [m²°C]	
1	0,00	538,76	75	75	27,58	55	538,76	S4b	6		538,76	89,79				538,76	365,34	538,76	
2	538,76	561,56	90	87,75	55	61,53	22,80	S1a	1,2	8,33	18,75	15,63	1,00	3,49	6,53	22,79	22,79	22,80	
								S4a	1	1,31	2,94	2,94							
								S5a	1	0,49	1,10	1,10							
3	561,56	597,44	110	90	61,53	66,08	35,88	S4a	1	1,307	26,14	26,14	0,80	2,68	1,08	2,89	3,62	35,88	
								S5a	1	0,487	9,74	9,74	0,80	2,72	1,08	2,94	3,67		
													1,00	1,49	1,08	1,61	1,61		
													1,30	11,64	1,08	12,56	9,66		
													1,00	3,49	4,55	15,87	15,87		
4	597,44	793,92	110	110	66,08	75	196,49	S3a	6,2		196,49	31,69	0,80	2,68	8,92	23,93	29,91	11,01	
													0,80	2,72	8,92	24,27	30,34		
													1,00	1,49	8,92	13,32	13,32		
													1,30	11,64	8,92	103,84	79,87		
													1,00	3,49	8,92	31,13	31,13		
5	793,92	863,34	110	110	75	79,44	69,41	S3a	6,2		69,41	11,20	0,80	2,68	4,44	11,91	14,88	11,57	
													0,80	2,72	4,44	12,08	15,10		
													1,00	1,49	4,44	6,63	6,63		
													1,40	5,25	4,44	23,31	16,65		
													1,00	3,49	4,44	15,49	15,49		
6	863,34	876,41	120	110	79,44	80,30	13,07	S4a	1	1,31	13,07	13,07	0,80	2,68	0,86	2,32	2,90	2,18	
													0,80	2,72	0,86	2,35	2,94		
													1,00	1,49	0,56	0,84	0,84		
													1,40	5,25	0,86	4,54	3,24		
													1,00	3,49	0,86	3,02	3,02		
h for hot water [kW/m²°C]								6											
h for intermediate steam [kW/m²°C]								1											
								6											
								Number of HE source											
								1											
								6											
								Number of HE sink											
								8											

Table 12 The number of heat exchangers of source and sink streams

EI		IU	T1 [°C]	T2 [°C]	dTa [°C]	dTb [°C]	dTlog [°C]	A [m²]	Amin [m²]
1	source	1	55,00	65,00	20,00	10,00	14,43	43,57	106,00
		2	50,00	65,00	25,00	10,00	16,37	38,40	131,27
		3	60,00	60,00	15,00	15,00	15,00	41,90	115,41
	sink	1	55,00	65,00	27,42	10,00	17,27	62,43	
		2	50,00	60,00	22,42	5,00	11,61	92,87	
		3	60,00	60,00	32,42	5,00	14,67	73,50	
2	source	1	77,75	80,00	10,00	10,00	10,00	4,25	6,47
		2	71,53	71,53	16,22	18,47	17,32	2,45	5,96
		3	71,53	77,75	16,22	12,25	14,14	3,00	5,79
		4	65,00	71,53	22,75	18,47	20,53	2,07	6,63
		5	75,00	75,00	12,75	15,00	13,84	3,07	5,83
		6	77,75	77,75	10,00	12,25	11,09	3,83	6,19
	sink	1	77,75	80,00	22,75	18,47	20,53	2,22	
		2	71,53	71,53	16,53	10,00	12,99	3,51	
		3	71,53	77,75	16,53	16,22	16,37	2,78	
		4	65,00	71,53	10,00	10,00	10,00	4,56	
		5	75,00	75,00	20,00	13,47	16,52	2,76	
		6	77,75	77,75	22,75	16,22	19,30	2,36	
3	source	1	80,00	100,00	10,00	10,00	10,00	7,18	9,94
		2	71,53	76,08	18,47	33,92	25,42	2,82	9,86
		3	80,00	80,00	10,00	30,00	18,20	3,94	8,31
		4	80,00	90,00	10,00	20,00	14,43	4,97	8,31
		5	71,53	81,53	18,47	28,47	23,11	3,11	8,72
		6	77,75	85,00	12,25	25,00	17,88	4,01	8,03
	sink	1	80,00	100,00	18,47	33,92	25,42	2,77	
		2	71,53	76,08	10,00	10,00	10,00	7,03	
		3	80,00	80,00	18,47	13,92	16,09	4,37	
		4	80,00	90,00	18,47	23,92	21,08	3,34	
		5	71,53	81,53	10,00	15,45	12,53	5,61	
		6	77,75	85,00	16,22	18,92	17,53	4,01	

Table 13 Calculation of Intermediate utility 1-3

4	source	1	100,00	100,00	10,00	10,00	10,00	4,27	10,96
		2	76,08	85,00	33,92	25,00	29,23	1,46	21,02
		3	76,08	100,00	33,92	10,00	19,58	2,18	14,13
		4	80,00	90,00	30,00	20,00	24,66	1,73	15,26
		5	85,00	100,00	25,00	10,00	16,37	2,61	11,57
		6	80,00	100,00	30,00	10,00	18,20	2,35	12,68
	sink	1	100,00	100,00	33,92	25,00	29,23	6,69	
		2	76,08	85,00	10,00	10,00	10,00	19,56	
		3	76,08	100,00	10,00	25,00	16,37	11,95	
		4	80,00	90,00	13,92	15,00	14,45	13,53	
		5	85,00	100,00	18,92	25,00	21,82	8,96	
		6	80,00	100,00	13,92	25,00	18,92	10,34	
5	source	1	100,00	100,00	10,00	10,00	10,00	2,28	5,81
		2	85,00	89,44	25,00	20,56	22,71	1,00	9,03
		3	90,00	90,00	20,00	20,00	20,00	1,14	7,49
		4	85,00	100,00	25,00	10,00	16,37	1,39	6,87
	sink	1	100,00	100,00	25,00	20,56	22,71	3,54	
		2	85,00	89,44	10,00	10,00	10,00	8,03	
		3	90,00	90,00	15,00	10,56	12,65	6,35	
		4	85,00	100,00	10,00	20,56	14,65	5,48	
6	source	1	100,00	110,00	10,00	10,00	10,00	1,52	2,13
		2	89,44	90,30	20,56	29,70	24,85	0,61	2,13
		3	100,00	100,00	10,00	20,00	14,43	1,06	1,81
		4	90,00	100,00	20,00	20,00	20,00	0,76	1,79
		5	90,00	110,00	20,00	10,00	14,43	1,06	1,87
	sink	1	100,00	110,00	20,56	29,70	24,85	0,61	
		2	89,44	90,30	10,00	10,00	10,00	1,51	
		3	100,00	100,00	20,56	19,70	20,13	0,75	
		4	90,00	100,00	10,56	19,70	14,66	1,03	
		5	90,00	110,00	10,56	29,70	18,51	0,82	
								Aiu [m ²]	138,39

Table 14 Calculation of Intermediate utility 4-6

Sink		Source		Final Intermediate Utility profile	
T[°C]	H [kW]	T[°C]	H [kW]	T[°C]	H [kW]
20	-176,278	120	876,406444	45	-176,2783
50	521,3117	110	863,336444	55	0
55	538,7617	110	597,436444	65	538,760953
65	573,6617	90	561,556444	67,74726	538,760953
67,747258	634,1728	87,74726	538,760953	71,53145	538,760953
70	683,7917	75	538,760953	77,74726	561,556444
75	793,9217	75	0	85	597,436444
80	872,1017			100	597,436444
85	942,8167			100	793,9217
90	1013,532			100	863,336444
100	1093,242			100	876,406444
102	1109,184			131	876,406444
109	1128,231			131	2478,9807
109	1509,341				
110	1509,341				
114	1511,517				
114	2214,617				
120	2217,881				
121	2217,881				
121	2478,981				
Hot utility	1778,853 kW				

Aiu	138,392152
Ahu	49,9443797
Ahen,a	21,6161434
Ahen,b	44,7710141
Ahen	254,723689

Joined together so i can have minimum temperature difference between sink and source profile of 20°C.
 Now I can put intermediate utility for both profiles inbetween so that dTmin between intermediate utility and each profile is 10°C.

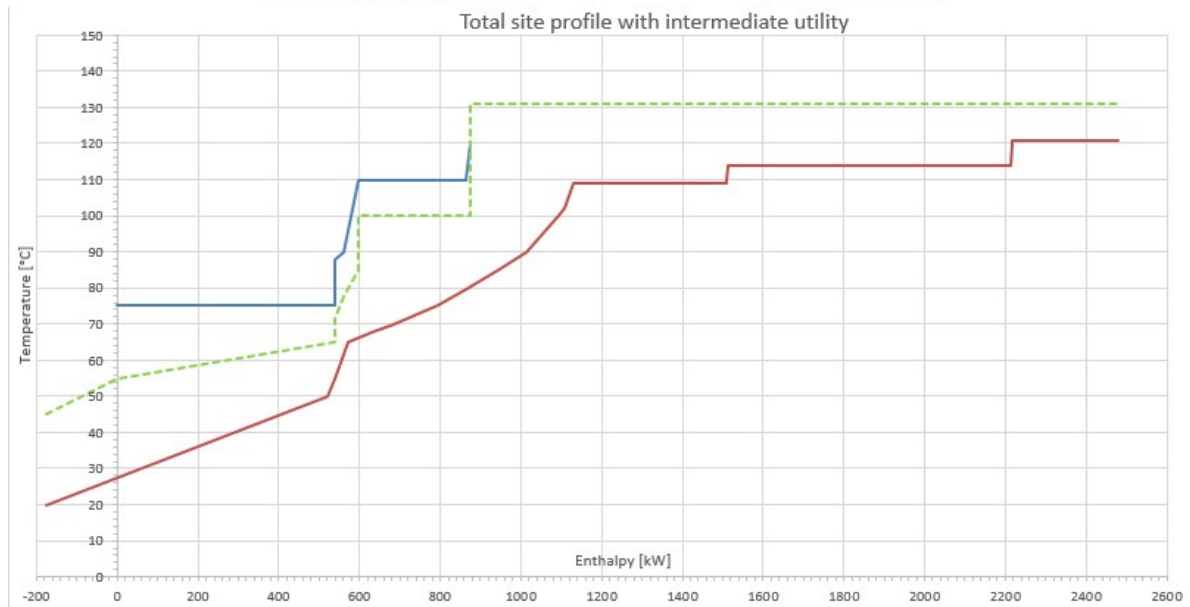

Figure 25 Final Total site profile with intermediate utility

4. ECONOMIC ANALYSIS

Price of hot utility	366	EUR/kWy	
Price of cold utility	36	EUR/kWy	
Specific price of heat transfer area	800	EUR/m ²	
Installation costs with revamp of 1 heat exchanger	10000	EUR	
Coefficient of nonlinearity of heat transfer area	0,87		
Plant life	5	years	
Return of investment	10%		
			A [m²]
Min. Hot utility A	266,54	kW	
Min. Cold utility A	320,1	kW	
Number of HE A	3		21,62
Min Hot utility B	1458,219	kW	
Min. Cold utility B	588,15	kW	
Number of HE B	7		44,77
Hot utility C	837,19	kW	
Number of total site HE for sink	8		
Number of total site HE fot Source	6		138,39
Number of HE for Hot utility	9		49,94
Sum number of HE	33		254,72
Hot utility heat	1778,85	kW	
hot utility without IU	2561,949	kW	
cold utility without IU	908,25	kW	
Hot utility no regen	3932,90	kW	
Cold utility no regen	2279,20	kW	

Table 16 Initial data for economic analysis

Table 16 shows initial data for the calculation of the savings. The surfaces shown are for heat exchangers on the left from the number. The surface which is on the right side of the source heat exchangers is for both sink and source heat exchangers. In further analysis the difference between total site regeneration and single site only regeneration will be calculated. In addition, the difference between total site regeneration and no regeneration at all will be calculated.

As shown in the table 17, the calculations were made. Every number in table 17 is in euros. Since the plant life is 5 years, the initial expenses and expenses for next 5 years were calculated. The initial expense in year 0 for heat exchanger cost is 378 564,71 euros, by equation (36) [2].

$$IE = N_{HE} \cdot ICR + \sum_{I=1}^n (A_n \cdot SPA)^c \quad (36)$$

N_{HE} = The number of hear exchanger

ICR = Installation costs with revamp of 1 HE

A_n = the surface of heat exchangers for each proces. "n" is the number of process and total site (A,B,C, total site)

SPA = specific price of heat transfer area

C = coefficient of nonlinearity of heat transfer area

The coefficient of nonlinearity of heat transfer area means that larger heat exchangers will be cheaper per transfer area to produce.

Also, single site initial expenses were calculated the same way as total site expenses, but with less heat exchangers and smaller surface. Furthermore, the expenses for hot utility each year were calculated simply by multiplying the hot utility needed for total site with the cost of heat per kW year. The same with cold utility.

In table 18 it is clear that savings are large amounts. The initial expense of heat exchangers is low compared to savings made using regeneration. Savings A are savings between total site regeneration and single site regeneration. Savings B show savings between total site regeneration and no regeneration at all. By calculating net present value by discount rate of 10% and summing savings during 5 years we get around **945.899,39 euros** of saving of present value money over single site regeneration and almost **2.921.058,15 euros** of savings of present value money over no regeneration at all (Table 18). This numbers are large because the price of hot and cold utility is not cheap at all, and the expenses for heat exchangers are relatively low.

Year	0	1	2	3	4	5
Heat exchangers cost	378.564,71	0,00	0,00	0,00	0,00	0,00
Hot utility	0,00	651.060,04	651.060,04	651.060,04	651.060,04	651.060,04
Cold utility	0,00	0,00	0,00	0,00	0,00	0,00
Total site regeneration	378.564,71	651.060,04	651.060,04	651.060,04	651.060,04	651.060,04
HE cost	114.026,84	0,00	0,00	0,00	0,00	0,00
hot utility	0,00	937.673,33	937.673,33	937.673,33	937.673,33	937.673,33
Cold utility	0,00	32.697,00	32.697,00	32.697,00	32.697,00	32.697,00
Regeneration inside each process only	114.026,84	970.370,33	970.370,33	970.370,33	970.370,33	970.370,33
HE cost	0,00	0,00	0,00	0,00	0,00	0,00
Hot utility	0,00	1.439.441,03	1.439.441,03	1.439.441,03	1.439.441,03	1.439.441,03
Cold utility	0,00	82.051,20	82.051,20	82.051,20	82.051,20	82.051,20
No regeneration at all	0,00	1.521.492,23	1.521.492,23	1.521.492,23	1.521.492,23	1.521.492,23

Table 17 Savings calculation

Year	0	1	2	3	4	5
Savings A [EUR]	-264.537,87	319.310,30	319.310,30	319.310,30	319.310,30	319.310,30
Savings B [EUR]	-378.564,71	870.432,20	870.432,20	870.432,20	870.432,20	870.432,20
NPV A [EUR]	-264.537,87	290.282,09	263.892,81	239.902,55	218.093,23	198.266,57
NPV B [EUR]	-378.564,71	791.302,00	719.365,45	653.968,59	594.516,90	540.469,91
TOTAL NPV A [EUR]		945.899,39				
TOTAL NPV B [EUR]		2.921.058,15				

Table 18 Savings

5. CONCLUSION

After reviewing literature, the methods were chosen for Total site calculations and separate processes regenerations. The regeneration achieved in process A is 1004,20 kW using 3 heat exchangers whose surface is 21,62 m². Hot utility needed is 266,54 kW, and needed cold utility is 320,1 kW. Furthermore, the larger process, Process B, achieved 1275 kW of recovered power using 7 heat exchangers whose surface is 44,77 m². Hot utility is 1458,22 kW, and cold utility is 588,15 kW. After that, the intermediate utility was constructed. The utility recovered total 876,41 kW of power via 8 heat exchangers for heat sink and 6 HE for heat source. The surface of intermediate utility heat exchangers is 138,39 m². Lastly, the cold utility is 0 kW, and hot utility is 1778,85 kW. 9 heat exchangers are used for hot utility with surface of 49,94 m². For hot utility, hot water and hot steam is used.

It's obvious that a lot of heat is regenerated by this method resulting with savings of **2.921.058,15 euros** of today's worth money in 5 years compared to no regeneration at all. Only 378.564,71 euros of expenses is needed, and savings on hot and cold utility is enormous in one year. Also, compared to only inside process recovery **945.899,39 euros** of today's worth money were saved in 5 years. The project uses plate heat exchangers from the Alfa Laval heat exchanger manufacturer which is the data for costs of utility taken from. According to this manufacturer more than 50% of unnecessary energy is used in overall world process industry. Which shows there is a great chance of improvement. Using Total regeneration combined with renewable sources of energy, world industry could make a great economic and ecologic leap forward with this smart energy saving method.

REFERENCES

- [1] Jiri Klemes, Ferenc Friedler, Igor Bulatov, Petar Varbanov: Sustainability in the process industry, McGraw Hill Professional, 2010.
- [2] Ian C. Kemp: Pinch Analysis and Process Integration, Elsevier Ltd., 2007.
- [3] Klemeš J, Dhole VR, Raissi K, Perry S, Puigjaner L. Targeting and design methodology for reduction of fuel, power and CO₂ on total sites. *Appl Therm Eng* 1997;17(8–10):993–1003.
- [4] Ahmad S, Linnhoff B, Smith R. Cost optimum heat exchanger networks: 2. Targets and design for detailed capital cost models. *Comput Chem Eng* 1990;14(7):751–67.
- [5] Townsend DW, Linnhoff B. Surface area targets for heat exchanger networks. In: IChemE 11th Annual Research Meeting, Bath, UK; 1984. [lecture 7a].
- [6] Dhole VR, Linnhoff B. Total site targets for fuel, co-generation, emissions, and cooling. *Comput Chem Eng* 1993;17:S101–9.
- [7] Handbook of Process Integration (PI): Minimisation of Energy and Water Use, Waste and Emissions. Editor: Klemeš J.J. Woodhead Publishing, 2013
- [8] Smith R. Chemical process design and integration. Chichester, England: Wiley; 2005.
- [9] A. Nemet, S. Boldyryev, P. S. Varbanov, P. Kapustenko, J. J. Klemeš. Capital Cost Targeting of Total Site Heat Recovery. *Chemical Engineering Transactions*, 2012, 29, 1447-1452.
- [10] Stanislav Boldyryev, Petar Sabev Varbanov, Andreja Nemet, Jiří Jaromír Klemeš, Petro Kapustenko. Capital Cost Assessment for Total Site Power Cogeneration. *Computer Aided Chemical Engineering*, Volume 32, 2013, p. 361-366.
- [11] S. Boldyryev, P. S. Varbanov, A. Nemet, P. Kapustenko, J. J. Klemeš. Targeting Minimum Heat Transfer Area for Heat Recovery on Total Sites. *Chemical Engineering Transaction*, 2013. 35, 79-84.
- [12] Stanislav Boldyryev, Petar Sabev Varbanov, Andreja Nemet, Jiří Jaromír Klemeš, Petro Kapustenko. Minimum heat transfer area for Total Site heat recovery. *Energy Conversion and Management*. 2014, Vol. 87, 1093–1097.
- [13] Stanislav Boldyryev, Petar Sabev Varbanov. Process Integration for Bromine Plant. *Chemical Engineering Transaction*, 2014, 39, 1423-1428.
- [14] Boldyryev S., Varbanov, P.S. Low potential heat utilization of bromine plant via integration on process and Total Site levels. *Energy*. 2015. Vol. 90(1), 47-55.
- [15] Boldyryev S., Krajačić G., Duić N., Varbanov P.S. Cost Minimisation for Total Site Heat Recovery. *Chemical Engineering Transaction*, 2015, 45, 157-162.
- [16] Boldyryev S., Mikulčić H., Mohorović Z., Vujanović M., Krajačić G., Duić N. The improved heat integration of cement production under limited process conditions: A case study for Croatia. *Applied Thermal Engineering*, 2016, Vol. 105, 839-848.
- [17] S. Boldyryev, H. Mikulčić, G. Krajačić, N. Duić. Waste heat utilisation of Croatian cement industry accounting Total Site demands. *Computer Aided Chemical Engineering*, Vol. 38, 2016, 2223-2228.

ATTACHMENTS

I. CD-R disc