

Ispitivanje i analiza značajki rada dvo-gorivnog motora

Blažić, Mislav

Master's thesis / Diplomski rad

2016

Degree Grantor / Ustanova koja je dodijelila akademski / stručni stupanj: **University of Zagreb, Faculty of Mechanical Engineering and Naval Architecture / Sveučilište u Zagrebu, Fakultet strojarstva i brodogradnje**

Permanent link / Trajna poveznica: <https://um.nsk.hr/um:nbn:hr:235:263290>

Rights / Prava: [In copyright](#) / [Zaštićeno autorskim pravom.](#)

Download date / Datum preuzimanja: **2024-08-08**

Repository / Repozitorij:

[Repository of Faculty of Mechanical Engineering and Naval Architecture University of Zagreb](#)



UNIVERSITY OF ZAGREB
FACULTY OF MECHANICAL ENGINEERING AND NAVAL
ARCHITECTURE

MASTER THESIS

Mislav Blažić

Zagreb, 2016.

SVEUČILIŠTE U ZAGREBU
FAKULTET STROJARSTVA I BRODOGRADNJE

DIPLOMSKI RAD

Mislav Blažić

Zagreb, 2016.

UNIVERSITY OF ZAGREB
FACULTY OF MECHANICAL ENGINEERING AND NAVAL
ARCHITECTURE

MASTER THESIS

Supervisor:

Doc. dr. sc. Darko Kozarac

Student:

Mislav Blažić

Zagreb, 2016.

SVEUČILIŠTE U ZAGREBU
FAKULTET STROJARSTVA I BRODOGRADNJE

DIPLOMSKI RAD

Mentor:

Doc. dr. sc. Darko Kozarac

Student:

Mislav Blažić

Zagreb, 2016.

The work presented in this thesis was done by me as a result of a research on the experimental internal combustion engine at University of California, Berkeley.

I would first like to express my gratitude to my supervisor Darko Kozarac, PhD, for the given opportunity to join this research at University of California, Berkeley and for all needed help and guidance during the research that resulted with this thesis.

I am also very thankful to Ivan Taritaš, for helping me conduct the research at UC Berkeley and for all the advice and discussions that resulted with this thesis.

I would also like to thank my colleagues at UC Berkeley, David Vuilleumier and Miguel S. Aznar for creating a good working atmosphere at our department and for the given support and help around the experimental engine at the Combustion analysis Laboratory of UC Berkeley.

Mislav Blažić



SVEUČILIŠTE U ZAGREBU
FAKULTET STROJARSTVA I BRODOGRADNJE



Središnje povjerenstvo za završne i diplomske ispite
Povjerenstvo za diplomske ispite studija strojarstva za smjerove:
procesno-energetski, konstrukcijski, brodstrojarski i inženjersko modeliranje i računalne simulacije

Sveučilište u Zagrebu Fakultet strojarstva i brodogradnje	
Datum	Prilog
Klasa:	
Ur.broj:	

DIPLOMSKI ZADATAK

Student: **Mislav Blažić** Mat. br.: 0035181329

Naslov rada na hrvatskom jeziku: **Ispitivanje i analiza značajki rada dvo-gorivnog motora**

Naslov rada na engleskom jeziku: **Testing and Performance Analysis of Dual Fuel Engine**

Opis zadatka:

The main objectives in development of internal combustion engines are improvements in fuel consumption and tailpipe emissions. One of the methods for achieving the specified objectives is to implement and to use alternative fuels which burn more „cleaner“ and more efficient. One of the fuels with such characteristics is natural gas. Since the storages for natural gas are usually large and heavy the fuel is more appropriate for commercial vehicles which are usually powered by Diesel engines. In Diesel engines natural gas combust in so called dual fuel combustion mode, in which the premixed mixture of natural gas and air is ignited by a small fraction of directly injected Diesel fuel. For this thesis it is necessary to test the engine in dual fuel combustion mode at several selected operating points and to analyze the influence of mass of injected diesel fuel, of injection timing and of injection pressure on various engine performance features such as: efficiency, emissions, IMEP, CoV IMEP, etc. In the thesis it is therefore necessary to:

1. Describe the operation of dual fuel engines.
2. Describe the modification of Diesel engine for dual fuel operation.
3. Describe the experimental setup.
4. Describe the experimental plan and method of testing.
5. Show and analyze the results.
6. Present conclusions.

During thesis preparation one must comply with the standard rules for preparation of Master thesis.

It is necessary to list all literature used and received assistance.

Zadatak zadan:

5. svibnja 2016.

Rok predaje rada:

7. srpnja 2016.

Predviđeni datumi obrane:

13., 14. i 15. srpnja 2016.

Zadatak zadao:

Predsjednica Povjerenstva:

Doc. dr. sc. Darko Kozarac

Prof. dr. sc. Tanja Jurčević Lulić



SVEUČILIŠTE U ZAGREBU
FAKULTET STROJARSTVA I BRODOGRADNJE



Središnje povjerenstvo za završne i diplomske ispite
Povjerenstvo za diplomske ispite studija strojarstva za smjerove:
procesno-energetski, konstrukcijski, brodstrojarski i inženjersko modeliranje i računalne simulacije

Sveučilište u Zagrebu Fakultet strojarstva i brodogradnje	
Datum	Prilog
Klasa:	
Ur.broj:	

DIPLOMSKI ZADATAK

Student: **Mislav Blažić** Mat. br.: 0035181329

Naslov rada na hrvatskom jeziku: **Ispitivanje i analiza značajki rada dvo-gorivnog motora**

Naslov rada na engleskom jeziku: **Testing and Performance Analysis of Dual Fuel Engine**

Opis zadatka:

Smanjenje potrošnje goriva i smanjenje emisije štetnih tvari glavni su ciljevi u razvoju motora s unutarnjim izgaranjem. Jedan od načina na koji se to pokušava postići je upotreba alternativnih goriva koja izgaraju „čišće“ i učinkovitije, a jedno od takvih goriva je i prirodni plin. Prirodni plin je zbog načina skladištenja više primjeren za komercijalni transport koji je uglavnom pogonjen Dieselovim motorima. Prirodni plin u Dieselovim motorima izgara s dvo-gorivnim tipom izgaranja (eng. dual fuel) u kojem se predmješana smjesa zraka i prirodnog plina pali mlazom dizelskog goriva ubrizganog u kasnoj fazi kompresije. U ovom radu potrebno je eksperimentalno ispitati rad motora s dvo-gorivnim izgaranjem u nekoliko selektiranih radnih točaka i prikazati utjecaje mase ubrizganog dizelskog goriva, trenutka ubrizgavanja i tlaka ubrizgavanja na značajke rada motora kao što su: učinkovitost, štetne emisije, srednji indicirani tlak, koeficijent varijacije srednjeg indiciranog tlaka itd. U radu je stoga potrebno:

1. Opisati način rada dvo-gorivnog motora.
2. Opisati preinaku Dieselovog motora na dvo-gorivni.
3. Opisati pripremu eksperimentalnog postava.
4. Opisati eksperimentalni plan i način mjerenja.
5. Prikazati i analizirati rezultate mjerenja.
6. Izvesti zaključke.

Pri izradi se treba pridržavati uobičajenih pravila za izradu diplomskoga rada.

U radu navesti korištenu literaturu i eventualno dobivenu tuđu pomoć.

Zadatak zadan:
5. svibnja 2016.

Rok predaje rada:
7. srpnja 2016.

Predviđeni datumi obrane:
13., 14. i 15. srpnja 2016.

Zadatak zadao:

Predsjednica Povjerenstva:

Doc. dr. sc. Darko Kozarac

Prof. dr. sc. Tanja Jurčević Lulić

TABLE OF CONTENTS

TABLE OF CONTENTS	I
LIST OF FIGURES.....	III
LIST OF TABLES	VI
NOMENCLATURE.....	VII
SUMMARY	IX
PROŠIRENI SAŽETAK	X
1 INTRODUCTION.....	1
1.1 The internal combustion engine	1
1.2 Combustion process.....	1
1.3 Emissions from combustion engines	2
1.4 Dual fuel engine.....	4
1.5 Dual fuel engine challenges.....	4
1.6 Emissions from dual fuel engines.....	6
1.7 Fuel injection	7
1.8 Engine parameters	7
2 EXPERIMENTAL SETUP	10
2.1 Volkswagen 2.0 TDI engine.....	10
2.2 Experimental engine	17
2.3 Modified direct fuel injection	19
2.4 Modified port fuel injection.....	20
2.5 Control system.....	20
2.6 Data acquisition	25
2.7 Exhaust gas analyzers.....	28

3	Research plan	31
3.1	Design of Experiments	31
3.2	Engine Performance Calculation	32
4	RESULTS.....	34
4.1	Effect of diesel fuel mass.....	35
4.2	Effect of injection timing.....	41
4.3	Effect of diesel fuel injection pressure	46
4.4	Effect of engine speed	51
5	GENERAL OVERVIEW AND CONCLUSIONS	57
	REFERENCES.....	58

LIST OF FIGURES

Figure 1. Rate of heat release for CI [] (left) and SI [1] (right) engines	2
Figure 2. Rate of heat release [18]	5
Figure 3. Example of a schematic diagram of a dual fuel system [20]	7
Figure 4. Diesel substitution rate [18].	9
Figure 5. Volkswagen Jetta 2010	10
Figure 6. Power and torque (left) and brake mean effective pressure (right) characteristics [17]	11
Figure 7. Piston [17]	12
Figure 8. Valves in the cylinder head [17]	13
Figure 9. Valve lift profiles	14
Figure 10. Fuel system [17]	15
Figure 11. Fuel injector [17]	16
Figure 12. High-pressure fuel pump [17]	17
Figure 13. Experimental engine	18
Figure 14. Direct fuel injection system	19
Figure 15. Port fuel injection system	20
Figure 16. Port fuel injector	20
Figure 17. DI Driver System Configuration with optional NI 9215 and PFI driver [21]	21
Figure 18. DI Driver System Configuration in the experimental setup	21
Figure 19. Diagram of typical wiring of piezo injectors to a DI Driver Module [21]	22
Figure 20. Direct injection control window	22
Figure 21. Diagram of typical wiring of port fuel injectors to a PFI Driver Module [21]	23
Figure 22. Port fuel injection control window	23
Figure 23. Diagram of typical wiring of an Inlet Metering Valve and a High Pressure Valve to a PFI Driver Module [21]	24
Figure 24. Rail Pressure Control Window	25

Figure 25. Pressure sensor (left) with measurement cable (middle) a charge amplifier (right) [22].....	25
Figure 26. Air (left) and methane (right) flow meters.....	26
Figure 27. LabVIEW engine management window.....	27
Figure 28. In-cylinder pressure for loads with different percentages of diesel substitution rate	32
Figure 29. Change in equivalence ratios with the change of diesel fuel mass.....	36
Figure 30. Effect of diesel fuel mass on in-cylinder pressure at low load.....	37
Figure 31. Effect of diesel fuel mass on in-cylinder pressure at mid load.....	37
Figure 32. Effect of diesel fuel mass on in-cylinder pressure at high load.....	37
Figure 33. Effect of diesel fuel mass on IMEPg (left) and diesel substitution rate (right)	38
Figure 34. Effect of diesel fuel mass on CoV in IMEPg (left) and indicated efficiency (right).....	38
Figure 35. Effect of diesel fuel mass on HC (left), CO (middle) and NO _x (right) emissions	39
Figure 36. Change in equivalence ratios with the change of injection timing.....	41
Figure 37. Effect of injection timing on in-cylinder pressure at low load.....	41
Figure 38. Effect of injection timing on in-cylinder pressure at mid load.....	42
Figure 39. Effect of injection timing on in-cylinder pressure at high load.....	42
Figure 40. Effect of injection timing on IMEPg (left) and diesel substitution rate (right)	43
Figure 41. Effect of injection timing on CoV in IMEPg (left) and indicated efficiency (right).....	43
Figure 42. Effect of injection timing on HC (left), CO (middle) and NO _x (right) emissions	44
Figure 43. Change in equivalence ratios with the change of injection pressure	46
Figure 44. Effect of injection pressure on in-cylinder pressure at mid load.....	46
Figure 45. Effect of injection pressure on in-cylinder pressure at mid load.....	47
Figure 46. Effect of injection pressure on in-cylinder pressure at mid load.....	47

Figure 47. Effect of injection pressure on IMEPg (left) and diesel substitution rate (right).....	48
Figure 48. Effect of injection pressure on CoV in IMEPg (left) and indicated efficiency (right).....	48
Figure 49. Effect of injection pressure on HC (left), CO (middle) and NO _x (right) emissions	49
Figure 50. Air-diesel equivalence ratio for different sets of engine parameters	51
Figure 51. Air-methane equivalence ratio for different sets of engine parameters.....	51
Figure 52. Air-fuel equivalence ratio for different sets of engine parameters	52
Figure 53. Diesel substitution rates for different sets of engine parameters	52
Figure 54. Effect of engine speed on in-cylinder pressure.....	52
Figure 55. Effect of engine speed on in-cylinder pressure.....	53
Figure 56. Effect of engine speed on in-cylinder pressure.....	53
Figure 57. Effect of engine speed on indicated efficiency for different sets of engine parameters	54
Figure 58. Effect of engine speed on CoV in IMEPg for different sets of engine parameters	54
Figure 59. Effect of engine speed on HC emissions for different sets of engine parameters	55
Figure 60. Effect of engine speed on CO emissions for different sets of engine parameters	56
Figure 61. Effect of engine speed on NO _x emissions for different sets of engine parameters	56

LIST OF TABLES

Table 1. Engine characteristics.....	11
Table 2. Operating points	34

NOMENCLATURE

Notations

<i>Symbol</i>	<i>Unit</i>	<i>Description</i>
h	$\text{m}^2\text{kg/s}$	Planck's constant
H_D	MJ/kg	lower heating value
\dot{m}	g/s	mass flow
n	rpm	engine speed
N	/	number of cycles
$IMEP$	bar	indicated mean effective pressure
$IMEP_m$	bar	mean IMEP of N cycles
p_{in}	bar	intake pressure
p_{inj}	bar	direct injection pressure
Q_i	J	fuel energy
SOI	$^{\circ}\text{CA}$	start of injection
$SUBST$	%	diesel substitution rate
ν	Hz	frequency
V	m^3	volume
W_i	J	indicated work
η	/	efficiency
α	$^{\circ}$	crank angle degree
κ	/	isentropic exponent
ω	s^{-1}	angular velocity

Abbreviations

<i>Symbol</i>	<i>Description</i>
---------------	--------------------

BTDC	before top dead center
C ₃ H ₈	propane
CAD	crank angle degree
CH ₄	methane
CI	compression ignition
CO	carbon monoxide
CO ₂	carbon dioxide
COV	coefficient of variation
DC	direct current
DI	direct injection
EGR	exhaust gas recirculation
H ₂ O	water
HC	unburned hydrocarbons
HCCI	homogeneous charge compression ignition
IMEP	indicated mean effective pressure
IMEPg	indicated mean effective pressure gross
NI	national instruments
NO	nitrogen oxide
NO ₂	nitrogen dioxide
NO _x	nitrogen oxides
O ₂	oxygen
O ₃	ozone
PFI	port fuel injection
RCCI	reactivity controlled compression ignition
SI	spark ignition
TDC	top dead center

SUMMARY

With the increase of ecology standards, implementation of gaseous fuels is being studied. One of the most researched alternative fuels, due to its widespread availability and low cost is natural gas. It has been shown that the use of natural gas as a transportation fuel implies many improvements in terms of emissions. Due to the higher efficiency of compression ignited engines, implementation of natural gas in compression ignited engines is being studied. However, because of the high octane rating of natural gas, a small amount of high cetane fuel must be used to ignite the mixture. The engine then uses different fuels at the same time and is called a dual fuel engine. The objective of this thesis is to setup and study the diesel-methane dual fuel engine. An existing diesel engine has been converted to be able to run in the dual fuel operating mode. After the successful conversion, influences of the mass of injected diesel fuel, of the injection timing, of injection pressure and of engine speed on engine performance and emissions have been studied. It has been found that good combustion stability and lower emissions can be achieved at mid and high load with an optimum combination of engine parameters. On the other hand, operation under low load is characterized with unstable combustion coupled with low efficiency and high HC and CO emissions.

Key words: dual-fuel engine, diesel, natural gas, injection pressure, injection timing

PROŠIRENI SAŽETAK

Uvod

U današnje vrijeme, vozila su generalno pogonjena s jednom od dvije vrste motora, motorom s vanjskim izvorom paljenja ili kompresijskim motorom. Motor s vanjskim izvorom paljenja koristi benzinsko gorivo koje je u smjesi sa zrakom. Vanjski izvor paljenja osigurava električnu iskrnu koja zatim zapaljuje smjesu goriva i zraka. U kompresijskim motorima, zbog dobre zapaljivosti dizelskog goriva, visoka temperatura kompresije osigurava samozapaljenje.

I benzinsko i dizelsko gorivo su produkti prerade nafte, tj. fosilna su goriva. Kako je to konačan resurs, alternativna goriva se istražuju te su poneka pronašla upotrebu u današnjim vozilima. Jedno od najraširenijih alternativnih goriva je prirodni plin [2]. To je plinovito fosilno gorivo, čiji je glavni sastojak metan. Kako se smatra da su zalihe prirodnog plina izuzetno veće od zaliha nafte, prirodni plin kao gorivo motora s unutarnjim izgaranjem je predmet mnogih istraživanja.

Kako propisi vezani za emisije ispušnih plinova postaju sve stroži, razvoj motora s unutarnjim izgaranjem je usmjeren prema optimizaciji procesa izgaranja. U motorima s vanjskim izvorom paljenja, zbog visokog oktanskog broja prirodnog plina, on mora biti zapaljen pomoću električne iskre. U kompresijskim motorima, visoka temperatura nije dovoljna da osigura samozapaljenje metana. Zbog toga se u kompresijskim motorima koji koriste prirodni plin mora osigurati zapaljenje smjese pomoću drugog goriva. te tada motor radi u dvo-gorivnom načinu rada. Prirodni plin se tada koristi kao primarno gorivo, a dizelsko gorivo, koje se ubrizgava direktno u cilindar, se koristi u svrhu zapaljenja smjese. Glavna prednost dvo-gorivnih motora je jednostavna primjena na postojeće kompresijske motore uz male preinake [6].

Dvo-gorivni način rada

Kako je prirodni plin teško zapaljiv, u kompresijskim motorima dolazi do problema samozapaljenja. Prema vrsti ubrizgavanja, sljedeće dvo-gorivne strategije su predložne:

- Ubrizgavanje u usisnu cijev – postojeća smjesa prirodnog plina se zapaljuje ubrizgavanjem dizelskog goriva. Ovaj način rada naziva se konvencionalni dvo-gorivni način rada.

- Direktno ubrizgavanje – i prirodni plin i dizelsko gorivo se ubrizgavaju direktno u cilindar. Ovaj način ima karakteristike dizelskog izgaranja,
- HCCI/RCCI izgaranje u kojem se izgaranje kontrolira pomoću omjera prirodnog plina i dizelskog goriva

Konvencionalni dvo-gorivni način rada može se podijeliti u više faza, prikazanih na slici 1. Nakon zakašnjenja paljenja, dolazi do samozapaljenja dizelskog goriva (1). Nakon što dizelsko gorivo počne izgarati, mjesta unutar cilindra počinju stvarati difuzijske plamene. Ovakva mjesta se ponašaju kao izvori zapaljenja prirodnog plina (2). Kako postoji više izvora paljenja, nastaje više fronti plamena koje se šire smjesom prirodnog plina i zraka (3). Ukoliko se javi previsok porast tlaka, može doći do detotantnog izgaranja (4).

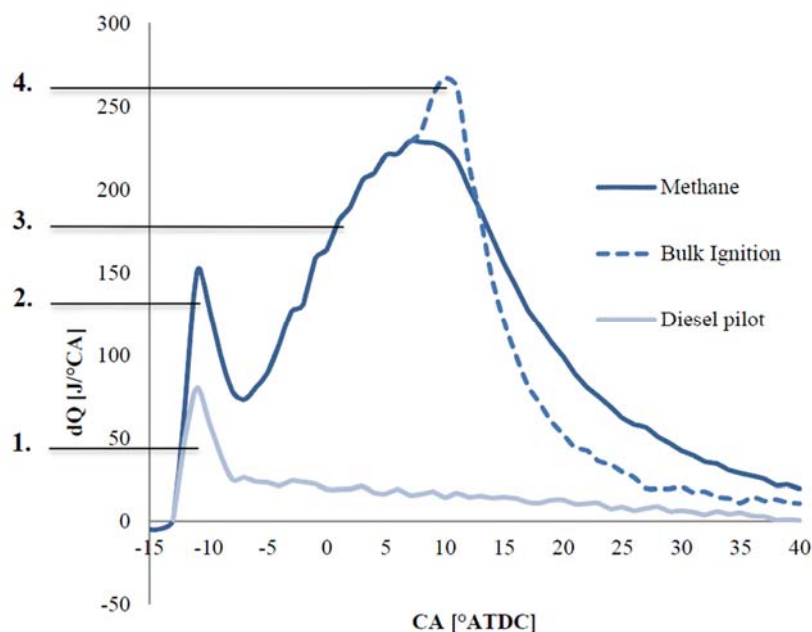

Slika 1. Brzina oslobađanja topline dvo-gorivnog motora

Iako dvo-gorivni način rada pokazuje potencijal, suočava se s pojedinim problemima:

- Veliki raspori karakteristični za dizelske klipove uzrokuju visoke emisije neizgorjelih ugljikovodika i ugljičnog monoksida u slučaju ubrizgavanja prirodnog plina u usisnu cijev,
- Otežano širenje plamena u slučaju siromašne smjese (rad s niskim opterećenjem),
- Detonantno izgaranje pri visokom opterećenju zbog visokog kompresijskog omjera.

Više eksperimentalnih istraživanja je provedeno te je otkriveno kako dvo-gorivni način rada smanjuje emisije čestica [8], dušičnih oksida [9] i ugljikovog dioksida [10] u odnosu na kompresijske motore. Iako donosi navedena poboljšanja, i dalje postoje problem u vidu povećanih neizgorjelih ugljikovodika [11] te visokih emisija ugljičnog monoksida [12].

Eksperimentalni postav

Eksperimentalni motor koji se koristio za istraživanje u ovom radu je 2.0L Volkswagenov motor. Navedeni motor je opremljen turbopunjačem, a ubrizgavanje goriva obavlja se direktno u cilindar. Motor je opremljen i sustavom recirkulacije ispušnih plinova. Maksimalna snaga motora je 103 kW na brzini vrtnje od 4000 min^{-1} , dok je maksimalni moment motora 320 Nm na brzinama vrtnje između 1750 i 2500 min^{-1} . Karakteristike motora prikazane su na slici 2.

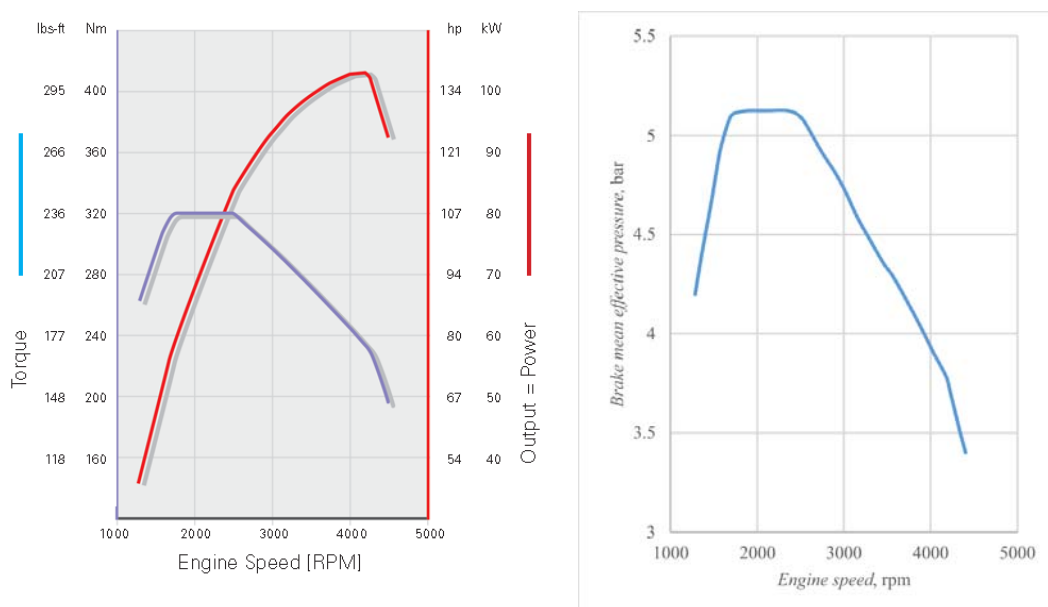

Slika 2. Karakteristike motora

U svrhu istraživanja, u navedenom motoru izgaranje se odvija samo u prvom cilindru. Metan, koji je glavni sastojak prirodnog plina, ubrizgava se u usisnu cijev, dok je dizelsko gorivo direktno ubrizgavano. Sustav direktnog ubrizgavanja prikazan je na slici 3. Zbog nedostatka pomoćne pumpe za gorivo, dizelsko gorivo u spremniku stlačuje se pomoću dušika na 4 bar. Dizelsko gorivo se tada dobavlja do visokotlačne pumpe koja osigurava visoki tlak za akumulator tlaka te u konačnici, za brizgaljke.

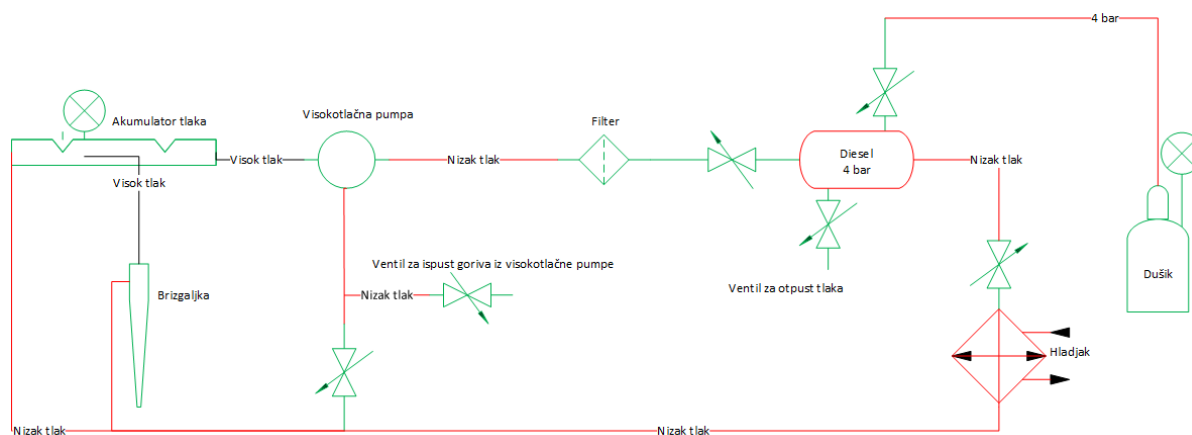

Slika 3. Sustav direktnog ubrizgavanja goriva

Povrati goriva iz akumulatora, s brizgaljki te iz visokotlačne pumpe spojeni su te se nalaze pod niskim tlakom od 4 bar. Povrat goriva tada prolazi kroz hladnjak kako bi se održala temperature dizelskog goriva od 30°C.

Programski paket National Instruments LabView koristi se kao sredstvo za upravljanje radom motora te za pohranu eksperimentalnih podataka. Za svaku radnu točku, krivulje tlaka u cilindru za 300 ciklusa su pohranjene s rezolucijom od 0.25°KV. Također, uz krivulju tlaka, pohranjuju se rezultati kao što su:

- brzina vrtnje,
- maseni protok metana, zraka i dizelskog goriva,
- omjeri zraka i goriva za dizelsko gorivo, za metan te ukupan omjer zraka i goriva,
- zamjena dizelskog goriva s metanom,
- srednji indicirani tlak,
- temperature goriva, usisa, rashladne tekućine, ulja, ispuha...
- itd.

U svrhu analize ispušnih plinova, koriste se HORIBA analizatori ispušnih plinova. Moguće je izmjeriti koncentracije neizgorjelih ugljikovodika, kisika, ugljičnog monoksida, ugljičnog dioksida te dušičnih oksida u ispuhu.

Eksperimentalni plan

Kako je prethodno spomenuto, za svaku radnu točku pohranjeno je 300 ciklusa. Dvije brzine vrtnje su analizirane uz držanje tlaka usisa na atmosferskim uvjetima od 1 bar. Potrebno

je proučiti utjecaj mase ubrizganog dizelskog goriva, trenutka ubrizgavanja te tlaka ubrizgavanja dizelskog goriva pri niskom, srednjem i visokom opterećenju. Rad motora u dvo-gorivnom načinu rada je analiziran pomoću indicirane efikasnosti, stabilnosti izgaranja te emisija ispušnih plinova. Korišteni parametri motora su sljedeći:

- Brzina vrtnje: 1000, 1800 min⁻¹
- Tlak usisa: 1 bar
- Tlak ubrizgavanja: 250, 500, 750, 1000 bar
- Trenutak ubrizgavanja: 40, 30, 20, 10 °KV prije GMT
- Maseni protok dizelskog goriva: 0.015, 0.03, 0.047, 0.06, 0.075, 0.085 g/s

Metan se ubrizgava pri tlaku ubrizgavanja od 2.5 bar 400°KV prije GMT.

Pri radu s niskim opterećenjem, srednji indicirani tlak je držan na 2 bar. Za rad sa srednjim opterećenjem, srednji indicirani tlak iznosio je 5 bar, dok je za visoko opterećenje motor radio s maksimalnim mogućim srednjim indiciranim tlakom.

Zaključak

Glavni cilj ovog rada bio je proučiti dvo-gorivni način rada. U tu svrhu, u homogenu smjesu metana i zraka ubrizgano je dizelsko gorivo koje se ponaša kao izvor paljenja.

Ustanovljeno je kako se pri srednjem i visokom opterećenju može postići stabilan rad. Zbog visoke koncentracije metana, veće brzine širenja plamena osiguravaju stabilno izgaranje. Emisije izgorjelih ugljikovodika i ugljičnog monoksida padaju, no pod cijenu izuzetnog porasta emisija dušikovih oksida u odnosu na nisko opterećenje. Nisko opterećenje očituje se niskom efikasnošću i visokom nestabilnosti izgaranja. Tada su emisije dušikovih oksida niske, no emisije neizgorjelih ugljikovodika i ugljičnog monoksida izuzetno rastu.

Detaljna analiza eksperimentalnih rezultata pokazala je da se može pronaći kombinacija parametara motora pri kojoj motor radi efikasno uz dobru stabilnost izgaranja te niske emisije. Sljedeći zaključci se mogu izvući na temelju opisane analize:

- Premala količina dizelskog goriva uzrokuje siromašnija područja koja imaju poteškoće zapaljenja, no prevelika količina dizelskog goriva uzrokuje visok porast tlaka te time štetne tlačne valove unutar cilindra motora,

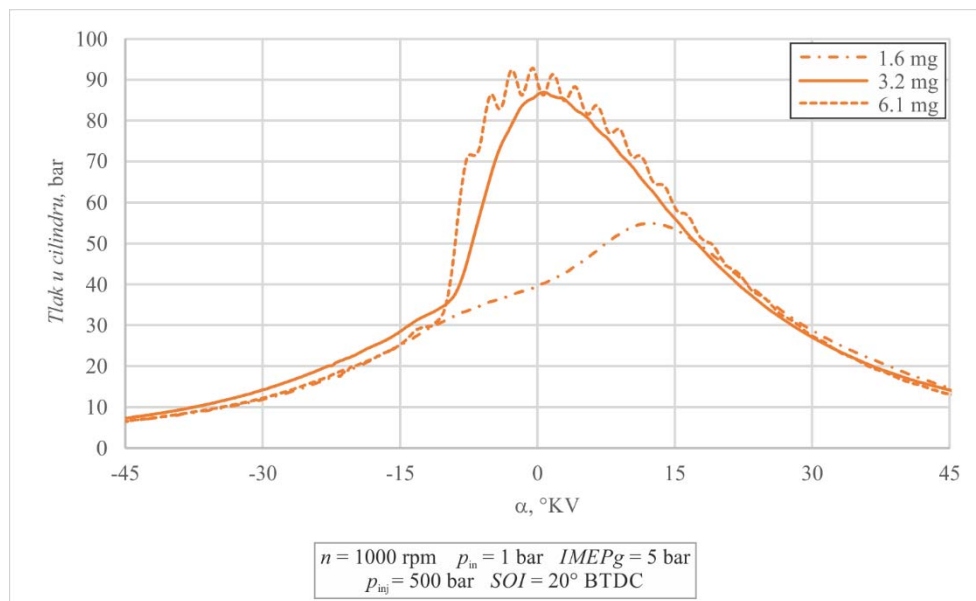

Slika 4. Utjecaj mase ubrizganog dizelskog goriva

- Ukoliko je trenutak ubrizgavanja raniji nego što je potrebno, dizelsko gorivo se ubrizgava u cilindar pri temperaturama koje nisu dovoljne za samozapaljenje. S druge strane, prekasno ubrizgavanje, tj. ubrizgavanja u previsoke temperature u cilindru uzrokuje visok porast tlaka te time tlačne valove unutar cilindra motora,

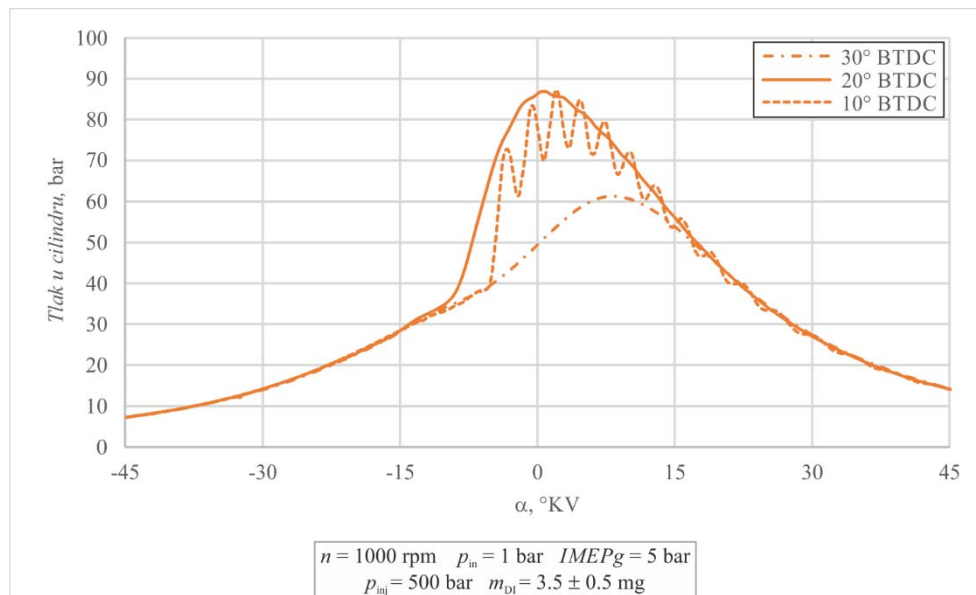

Slika 5. Utjecaj trenutka ubrizgavanja

- Nizak tlak ubrizgavanja dizelskog goriva uzrokuje premalo raspršivanje te time dolazi do prenoglog izgaranja. S druge strane, visok tlak ubrizgavanja rezultira siromašnijim zonama te većim zakašnjenjem paljenja.

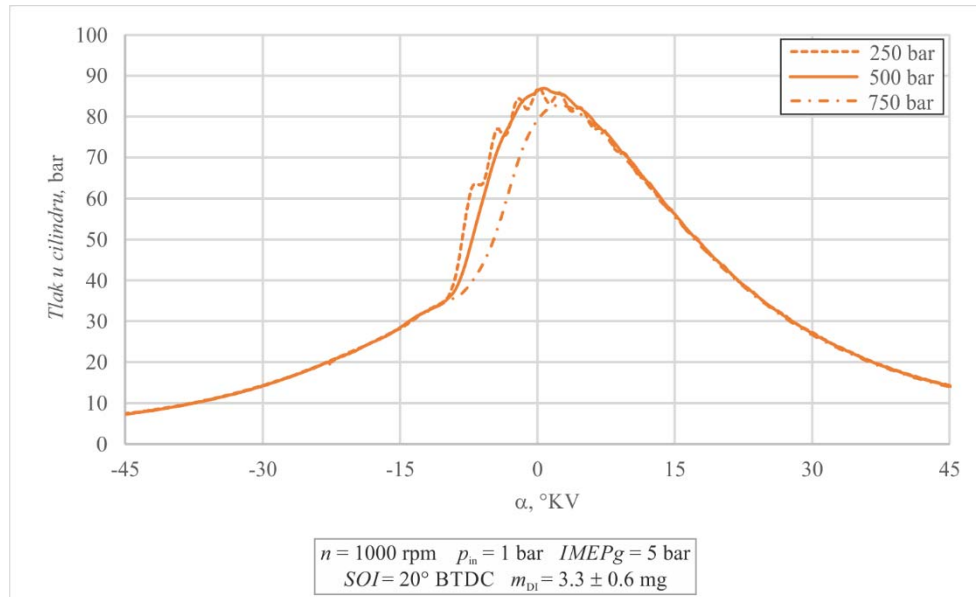

Slika 6. Utjecaj tlaka ubrizgavanja dizelskog goriva

Iz svega navedenog, jasno je da je potrebno nastaviti s istraživanjem dvo-gorivnog načina rada. Nakon dodatnih analiza, upotreba dvo-gorivnog načina rada u konvencionalnim vozilima možda bude omogućena, no izuzetno je važno riješiti postojeće probleme, kao što je rad na niskom opterećenju.

Ključne riječi: dvo-gorivni motor, dizel, prirodni plin, trenutak ubrizgavanja, tlak ubrizgavanja

1 INTRODUCTION

1.1 The internal combustion engine

In the 18th century, during the industrial revolution, steam engine became the first engine that saw widespread use. The steam engine is an external combustion engine, where combustion takes place outside the cylinder and water vapor is used to transfer work.

First internal combustion engines were burning a mixture of coal-gas and air without compression and had an efficiency of 5%. In 1876, Nikolaus Otto working with Eugen Langen developed a practical four-stroke engine. However, this engine had to be stationary because of the connection to the gas line. First internal combustion engines that were used to power vehicles were developed by Gottlieb Daimler and Karl Benz. Their engines had rated powers of 0.4 and 0.7 kW, respectfully [1].

After struggling with the idea of fuel being injected after the compression stroke into hot compressed air that would ignite it, in 1897, Rudolf Diesel created a working four stroke engine that had rated power of 13.1 kW at 154 rpm with brake specific fuel consumption of 324 g/kWh. This engine surpassed all other engines in terms of efficiency by maintaining it at 26%.

In the next hundred years, advances in many fields, such as materials used, casting methods, after treatment, engine geometry, complex injection strategies, complex combustion modes, software for engine control etc. have driven the development of both the spark ignition and the compression ignition engines into their current respective forms.

1.2 Combustion process

Today, vehicles are generally powered by the spark ignition or by the compression ignition engine. The spark ignition (SI) engine uses gasoline as fuel and premixed mixture of fuel and air. Ignition of the properly mixed air-fuel mixture is provided by an electrical spark. In compression ignition (CI) engines, high temperature caused by compressing air is sufficient for ignition. Rate of heat release for CI and SI engines is shown on Figure 1. It can be seen that CI engine combustion consists of multiple stages, which are: ignition delay, premixed combustion, controlled combustion and late combustion.

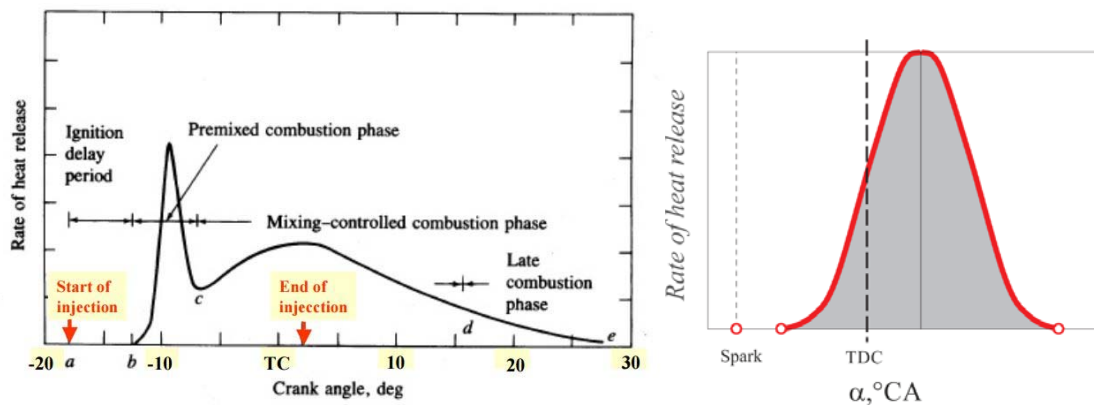

Figure 1. Rate of heat release for CI [1] (left) and SI [1] (right) engines

Diesel fuel used in CI engine has higher auto-ignition tendency (higher reactivity) and is less volatile, while the gasoline which is used in SI engine has much higher auto-ignition temperature, i.e. is much more resistant to auto-ignition. Both diesel fuel and gasoline are made from crude oil, which is a finite resource dependent on the availability and stability of fossil fuel supplies. Because of that, alternative fuels have been investigated and some have found use in today's vehicles. One of the widely used alternative fuels is natural gas [2]. It is a gaseous fossil fuel, consisting of various gas species. The properties of natural gas are very similar to those of methane, which is its primary constituent. It is considered that the natural gas reserves are significantly larger compared to crude oil and therefore the use and improvement of natural gas in internal combustion engines is widely investigated in terms of research of alternative fuels.

1.3 Emissions from combustion engines

Combustion of fuel in internal combustion engines leads to creation of exhaust gases that contain various species that have harmful environmental impact. Currently, emissions that are taken into account by legislation and certification of vehicles are unburned hydrocarbons (HC), carbon monoxide (CO), nitrogen oxides (NO_x) and soot which are considered as local emissions [3]. Reduction of emissions is done by exhaust gas after-treatment, optimizing the combustion process, fuel improvement etc.

Carbon dioxide (CO₂) emissions are limited by legislation, but are generally correlated to poor fuel economy and are therefore minimized in order to have a competitive product. Also, as the concentration of CO₂ in the atmosphere increases, global warming is becoming a growing issue. Because of that, CO₂ emissions are considered as global emissions.

1.3.1 Unburned hydrocarbons

Emissions of unburned hydrocarbons, HC, consist of fuel which escaped combustion for various reasons and of incomplete combustion products. They can be emitted when the flame does not reach the fuel-air mixture that entered into the crevices provided by the piston ring grooves or when there are very lean or rich zones that consequently have a low combustion temperature. Emitted into the atmosphere, HC can cause photochemical smog and diseases.

1.3.2 Carbon monoxide

CO is a harmful emission that is formed by a combination of incomplete burned fuel availability and in-cylinder combustion temperature, both of which control the rate of fuel decomposition and oxidation. Lack of oxygen in rich regions generates higher CO emission, but the low temperatures in fuel lean regions can also contribute to high CO emissions.

1.3.3 Nitrogen oxides

NO_x is a grouped emission mostly composed of nitrogen monoxide (NO) and nitrogen dioxide (NO₂). NO is the main component and usually accounts for more than 90% of NO_x formation inside the engine cylinder. NO_x are formed inside the cylinder when the temperatures at the end of combustion are high. NO_x emissions can cause respiratory diseases and destroy ozone layer at high altitudes.

1.3.4 Carbon dioxide

Carbon dioxide (CO₂) is a product of complete combustion of hydrocarbon fuels. After the oxidization of hydrocarbon to CO, in the latter stage of combustion when the in-cylinder temperature is high enough with the presence of oxygen, CO is oxidized to form CO₂. Thus, the formation of CO₂ strongly depends on the in-cylinder temperature and oxygen concentration.

1.3.5 Soot

Soot is a mass of impure carbon particles resulting from the incomplete combustion of hydrocarbons. The formation of soot depends strongly on the fuel composition. It is a major hazard to human health due to its small size, which then causes respiratory diseases.

1.4 Dual fuel engine

As the regulations regarding emissions are getting stricter, the internal combustion engine research is directed towards the optimization of the combustion process and the application of other, possibly “cleaner” fuels. As mentioned before, natural gas is one of the mainly used alternative fuels with potential to reduce local (NO_x and soot) emissions, but it is still not widely used in the internal combustion engines. Also, as natural gas consists primarily of methane (CH_4), it has high hydrogen to carbon ration so it has a theoretical potential to reduce global (CO_2) emissions [4].

Over the past years, natural gas has been used in both spark-ignition and compression-ignition engines. Because of the high octane rating, natural gas has high auto-ignition temperature which means it must be ignited by an electrical spark. In CI engines, the heat from the compressed air is not sufficient to provide ignition of methane. Therefore in CI engines dual-fuel operation is often used, in which the substitution of the conventional liquid fuel is not complete. Natural gas is used as a main energy source which is ignited by a small amount of high cetane number fuel (diesel) that is injected into the cylinder at the end of the compression stroke.

Worldwide usage of natural gas makes it an ideal candidate for use in dual-fuel operation. With its high octane number it is suitable for engines with relatively high compression ratio. It mixes uniformly with air, resulting in efficient combustion and a substantial depletion of some emissions in the exhaust gas [5]. Moreover, it is possible to apply this technology on existing Diesel engines with only minor modifications [6].

The effects of some engine parameters, such as injection timing, diesel fuel amount, gaseous fuel-air mixing system, air inlet preheating and exhaust gas recirculation (EGR) on the engine performance were examined [7].

1.5 Dual fuel engine challenges

The usage of natural gas in Diesel engines suffers from poor ignition characteristics due to the high auto-ignition temperature and low cetane number compared with diesel fuel. Therefore, the ignition source is always needed to ignite the natural gas in the Diesel engine cylinder. According to the way of injection of natural gas and the ignition source, several dual fuel strategies have been proposed:

- Port injection - premixed natural gas is ignited with diesel injection. This strategy is called *conventional dual fuel combustion* and it manifests with a blend of CI and SI engine like combustion,
- Direct injection – both natural gas and diesel fuel are directly injected into the cylinder. It manifests with a diesel like combustion,
- HCCI/RCCI combustion where combustion is controlled by the natural gas/diesel ratio (governed by the chemical reaction rate – HCCI).

The conventional dual fuel combustion process can be divided into multiple phases, which can be seen in Figure 2. After the diesel ignition delay, diesel fuel ignites (1). Once diesel fuel ignites and starts burning, multiple high temperature locations form within the cylinder (diffusion flames). The number of these locations primarily depends on the number of nozzle holes on the diesel fuel injector. These high temperature locations act as multiple spark plugs for the premixed natural gas - air mixture and once specific conditions (pressure, temperature, diffusion flame size) are obtained, combustion of natural gas within and around the diesel spray starts (2). Due to the existence of multiple locations of ignition of flame, the flame propagates through multiple flame surfaces across the premixed mixture (3). If the pressure rise rate is too high, bulk ignition, or engine knock (4) can occur.

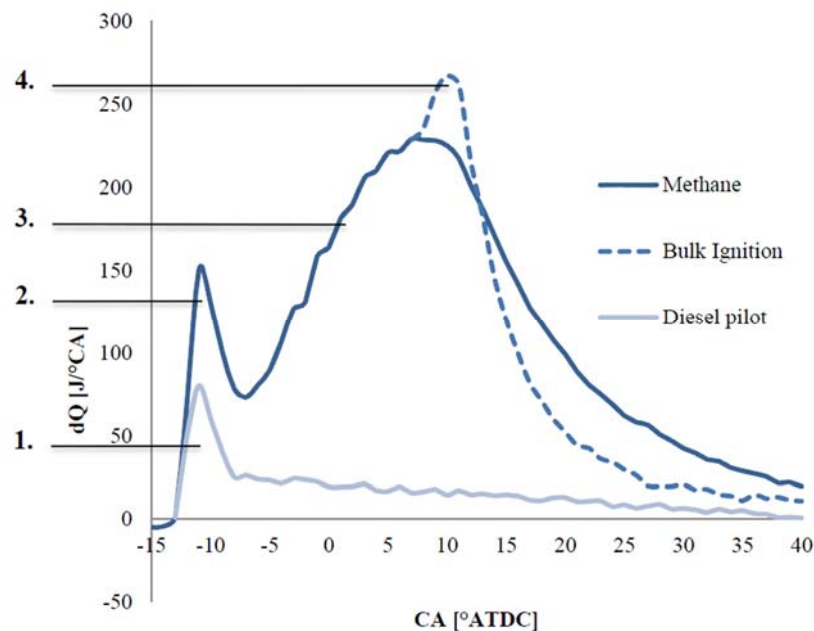

Figure 2. Rate of heat release [18]

Although dual fuel combustion has showed significant potential it still faces some challenges:

- Large crevice volume characteristics for Diesel engine pistons cause high HC and CO emissions when natural gas is port injected,
- Flame extinction or misfire occur when the mixture is too lean (low-load operation),
- Flame extinction can be overcome by throttled operation but then the engine suffers from deteriorated engine breathing in low-load operation,
- Pre-ignition and knock at high-load operation due to the large compression ratio.

1.6 Emissions from dual fuel engines

Numerous experimental studies report that the dual fuel combustion is efficient in reducing the soot [8], NO_x [9] and CO₂ [10] emissions from the Diesel engine, while maintaining high engine efficiency. Although it has shown a great potential, it still faces some challenges. Main problems with dual fuel combustion are excessive unburned hydrocarbons [11] and carbon monoxide [12] emissions in specific engine operating range.

Compared to normal diesel combustion, dual fuel combustion produces much more HC emissions. When trapped in the crevices, unburned fuel has much more difficulty to ignite, in the latter part of the combustion process, which in combination with flame quenching results with the increase in HC emission. Another reason for this increase can be found in the difficult flame propagation at low engine load conditions due to very lean fuel mixture [13].

Under natural gas-diesel dual fuel combustion mode in comparison to normal diesel mode CO emissions will be increased. The natural gas air mixture cannot be completely oxidized because of the low temperature during the expansion stroke so the CO emissions occur. This effect is enhanced with the increase of natural gas to diesel mass ratio [14].

The specific heat capacity ratio of natural gas is significantly higher than that of air. The addition of natural gas increases the overall heat capacity of the in-cylinder mixture which results in a reduction of the mean temperature at the end of compression stroke and during the overall combustion process. The lower combustion temperature leads to the reduction of NO_x formation compared to the Diesel engine [15].

Concerning global emissions, CO₂ emissions are significantly decreased with dual fuel combustion. Natural gas is mainly composed of methane which has one of the lowest carbon contents among all hydrocarbons so the production of CO₂ per unit of energy is lower than that of diesel [16].

1.7 Fuel injection

For this research, port injected methane is used to achieve dual fuel operation. Methane is injected in the intake port, into the fill channel. The mixture of air and gaseous fuel does not auto-ignite due to its high autoignition temperature. A small amount of diesel fuel is directly injected from the common rail near the end of compression stroke to ignite the mixture. The diesel fuel normally contributes only a small fraction of the engine power output.

The quantity of diesel fuel per cycle can usually be reduced to less than 10% of the total fuel amount supplied to the engine [19].

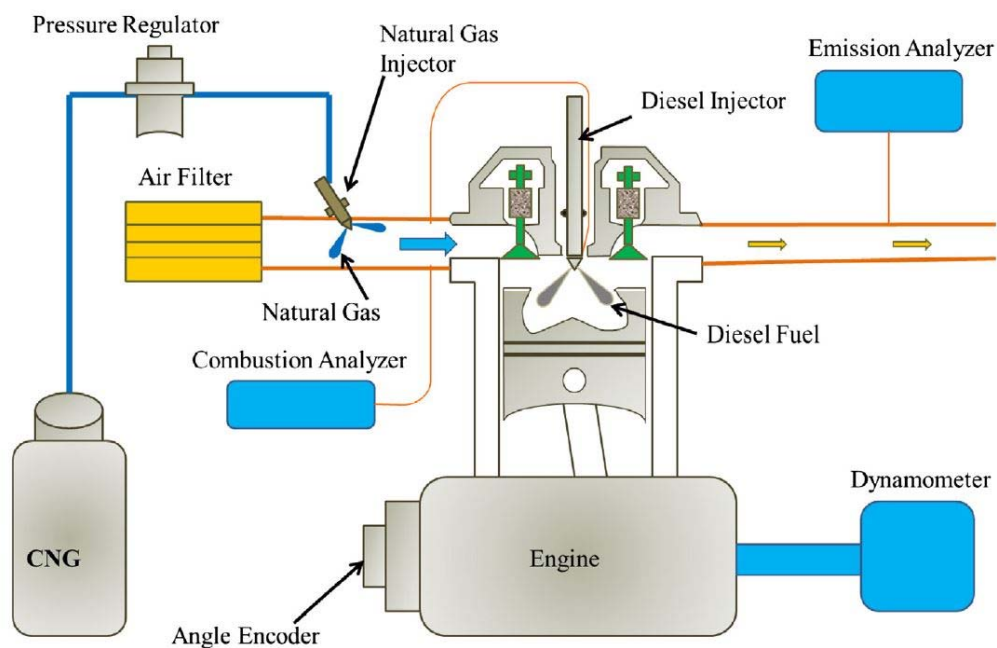

Figure 3. Example of a schematic diagram of a dual fuel system [20]

1.8 Engine parameters

Engine parameters that can be controlled and that have significant influence on the combustion process of the dual fuel engine are described in the following paragraphs.

1.8.1 Engine speed

Higher engine speeds have higher indicated efficiency due to the impact of the in-cylinder turbulence on the flame propagation. Furthermore, by increasing efficiency, higher engine speeds are lowering the difference between diesel and dual fuel engine efficiency.

1.8.2 Diesel fuel injection pressure

Increase of diesel fuel injection pressure can cause both increase and decrease of efficiency, HC, CO and NO_x emissions. This shows that the injection pressure is one of the main engine parameters that needs to be investigated.

1.8.3 Diesel fuel start of injection

By advancing the start of injection, HC and CO emissions are decreasing while the NO_x emissions and efficiency are increasing. On the other hand, start of injection that is too advanced can cause higher HC and CO emissions with lower NO_x emissions and lower efficiency. That is caused by the prolonged ignition delay which dilutes the spray which then does not achieve its auto-ignition temperature.

1.8.4 Mass of injected diesel fuel

The increase of the mass of diesel fuel injection causes a decrease in HC and CO emissions. Higher combustion temperatures cause the increase of NO_x emissions and efficiency. However, the increase of the mass of diesel fuel injection causes higher tendency to knock.

1.8.5 Diesel substitution rate

Diesel substitution rate is used to quantify the contribution of each fuel to the total amount of energy supplied. It determines the combustion characteristics and where the dual fuel engine fits on the scale between the SI and CI engine. Diesel substitution rate is calculated by equation (2.1):

$$SUBST = \frac{\dot{m}_{NG} \cdot H_{D,NG}}{\dot{m}_{NG} \cdot H_{D,NG} + \dot{m}_{DI} \cdot H_{D,DI}}, \quad (1.1)$$

where: \dot{m}_{NG} [kg/s] – mass flow of natural gas,

\dot{m}_{DI} [kg/s] – mass flow of diesel fuel,

$H_{D,NG}$ [MJ/kg] – lower heating value of natural gas,

$H_{D,DI}$ [MJ/kg] – lower heating value of diesel fuel.

The influence of diesel substitution rate on the share of specific fuel in the total supplied energy is shown in Figure 4.

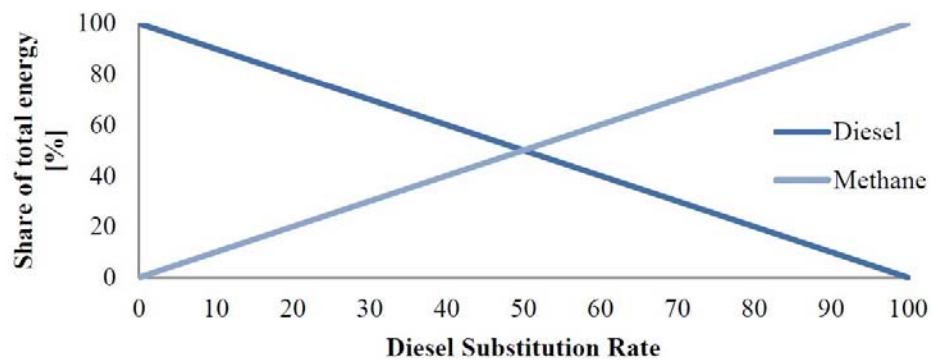

Figure 4. Diesel substitution rate [18].

2 EXPERIMENTAL SETUP

2.1 Volkswagen 2.0 TDI engine

Engine that will be used for the dual fuel experiments will be the 2.0 Liter engine taken from VW Jetta dating from 2010, seen in Figure 5. The 2.0 Liter TDI engine with common rail injection system is one of the most frequently built Diesel engines in the world and has seen the broadest use within the Volkswagen Group, from passenger cars to transport vehicles.

To accommodate the increasing demand for improvements in acoustics, fuel consumption, and exhaust gas emissions, a large number of engine components were redesigned. The conversion of the injection system to a common rail design is one of the major changes to this engine. Equipped with a special after-treatment system, this engine has met the needed emissions standards.



Figure 5. Volkswagen Jetta 2010

2.1.1 Technical characteristics

The 2.0 l TDI engine is a turbocharged Diesel engine that utilizes a common rail injection system with Piezo fuel injectors. It is equipped with Exhaust Gas Recirculation (EGR) and has a diesel particulate filter with upstream oxidation catalyst. Intake manifold has flap valve control, which will be described later. Maximum power output is 103 kW at 4000 rpm with maximum torque of 320 Nm between 1750 rpm and 2500 rpm, as can be seen in Figure 6.

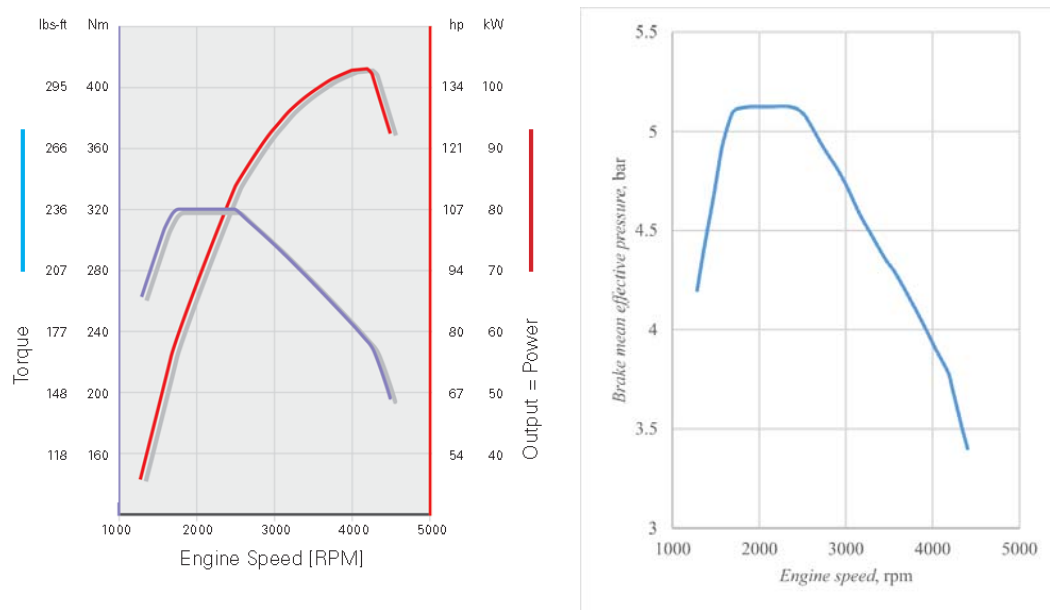

Figure 6. Power and torque (left) and brake mean effective pressure (right) characteristics [17]

All other technical characteristics are given in Table 1.

Table 1. Engine characteristics

Design	4-Cylinder In-Line Engine
Displacement	1968 cm ³
Bore	81 mm
Stroke	95,5 mm
Valves per Cylinder	4
Compression Ratio	16,5:1
Maximum Output	140 hp (103 kW) at 4000 rpm
Maximum Torque	320 Nm at 1750 rpm up to 2500 rpm
Engine Management	Bosch EDC 17 (Common Rail Control Unit)
Fuel	Ultra-Low Sulfur Diesel, under 15 ppm
Exhaust Gas Treatment	High and Low Pressure EGR, Oxidation Catalytic Converter, Diesel Particulate Filter, NOx Storage Catalytic Converter

2.1.2 Pistons

Pistons have no valve pockets. This reduces the cylinder clearance and improves the swirl formation in the cylinder. Swirl is the circular flow about the vertical axis of the cylinder and has a significant influence on the mixture formation.

For cooling of the piston ring zone, the piston accommodates an annular cooling channel in which oil is injected by piston spray jets.

The fuel is injected, circulated and mixed with air in the piston bowl, shown in Figure 7, which is designed so that the injected fuel allows more homogeneous carburation and reduces soot formation.

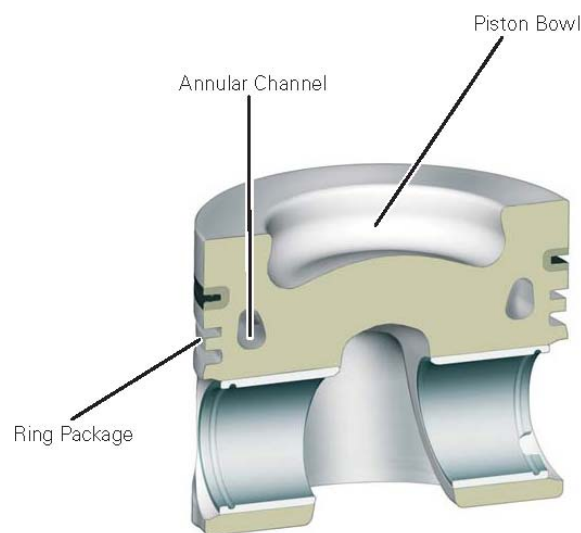

Figure 7. Piston [17]

2.1.3 Cylinder Head

The 2.0 Liter TDI common rail engine has a cross-flow aluminum cylinder head with two intake and two exhaust valves per cylinder, as shown in Figure 8. The valves are arranged vertically upright. The two overhead camshafts are linked by spur gears with an integrated backlash adjuster. They are driven by the crankshaft with a toothed belt and the exhaust camshaft timing gear. The valves are actuated by low-friction roller cam followers with hydraulic valve lash adjusters.

The vertically suspended and centrally situated fuel injector is arranged directly over the center of the piston bowl. Shape, size and arrangement of the intake and exhaust channels ensure a good degree of fill and a favorable charge cycle in the combustion chamber.

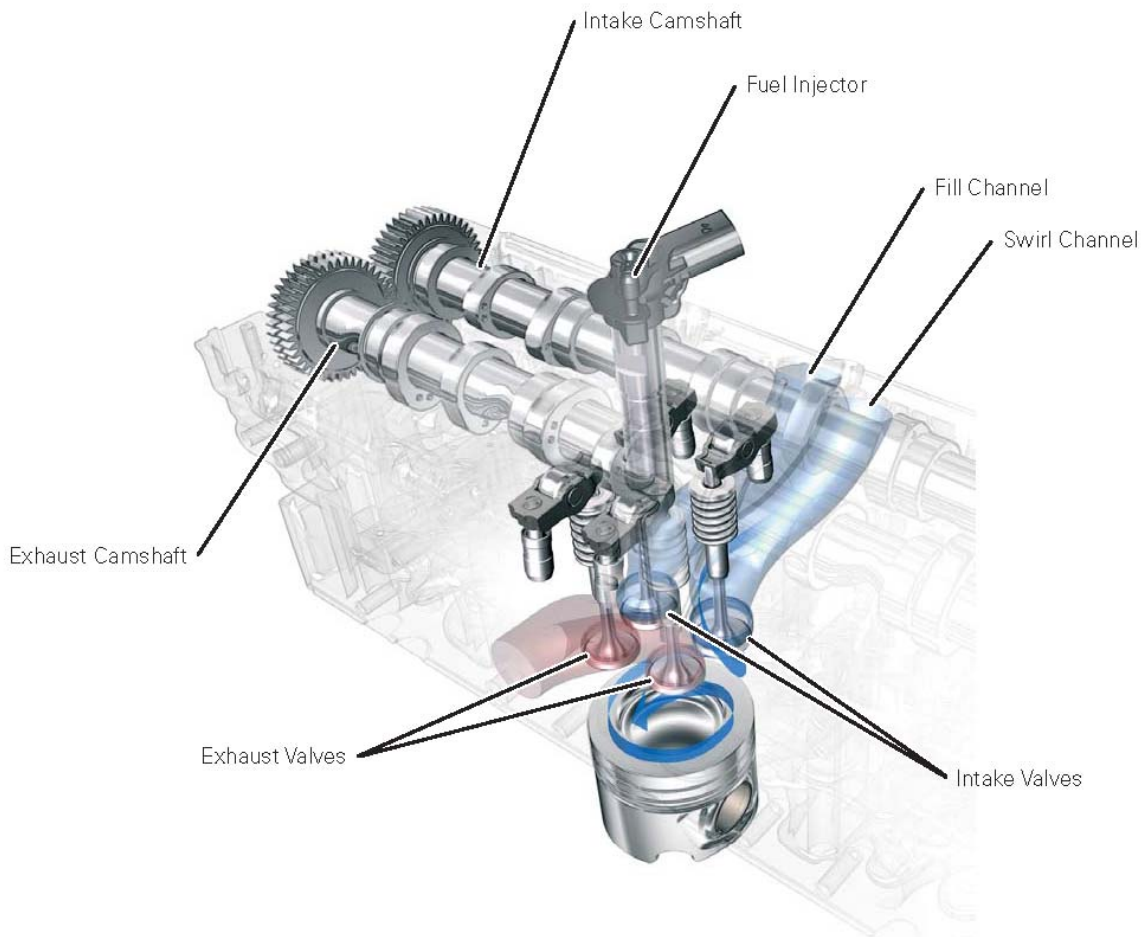

Figure 8. Valves in the cylinder head [17]

The intake ports are designed as swirl and fill channels. The air flowing in through the fill channels produces the desired high level of charge motion. The swirl channel ensures good air flow to the combustion chamber, particularly at high engine speeds. Because the intake manifold is equipped with flap valves on the fill channels, swirl flow inside the cylinder can be adjusted based on engine speed and load.

During idling and low engine speeds, the flap valves are closed. This leads to high swirl formation, with results in good mixture formation. During driving operation, the flap valves are

adjusted continuously, thus for each operating range the optimum air motion is ensured. They are completely opened at engine speeds higher than 3000 rpm.

2.1.4 Valve Lift

Valve lift profiles have been measured and are given in Figure 9. There is no overlap in the gas exchange process.

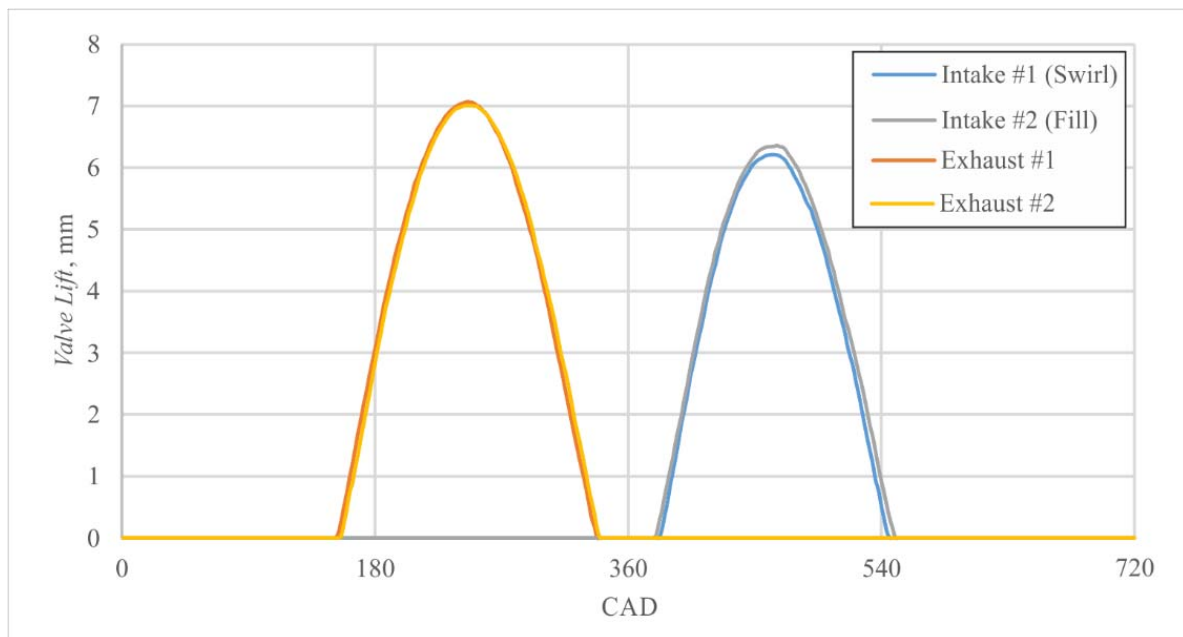

Figure 9. Valve lift profiles

2.1.5 Fuel system

The original fuel system is shown in Figure 10. Transfer fuel pump (1) feeds fuel continuously in the pre-supply area from the fuel tank. Fuel then flows to the fuel filter with preheating valve (2) which prevents the filter from becoming clogged due to crystallization of paraffin in low ambient temperatures. Auxiliary fuel pump (3) then feeds fuel to the high-pressure fuel pump, which has its own filter screen (4). High-pressure fuel pump (5) then generates high fuel pressure needed for the injection. Fuel needed for injection under high-pressure is being stored at the high-pressure accumulator (6), also known as the rail. Fuel pressure is regulated by the fuel pressure regulator valve (7) in the rail. Return lines from the high-pressure fuel pump and the rail are connected and the fuel then flows back to the fuel tank.

Because the pressure from the injector return lines is above the pre-supply area pressure, pressure retention valve (8) lowers the pressure before the connection to the other return lines.

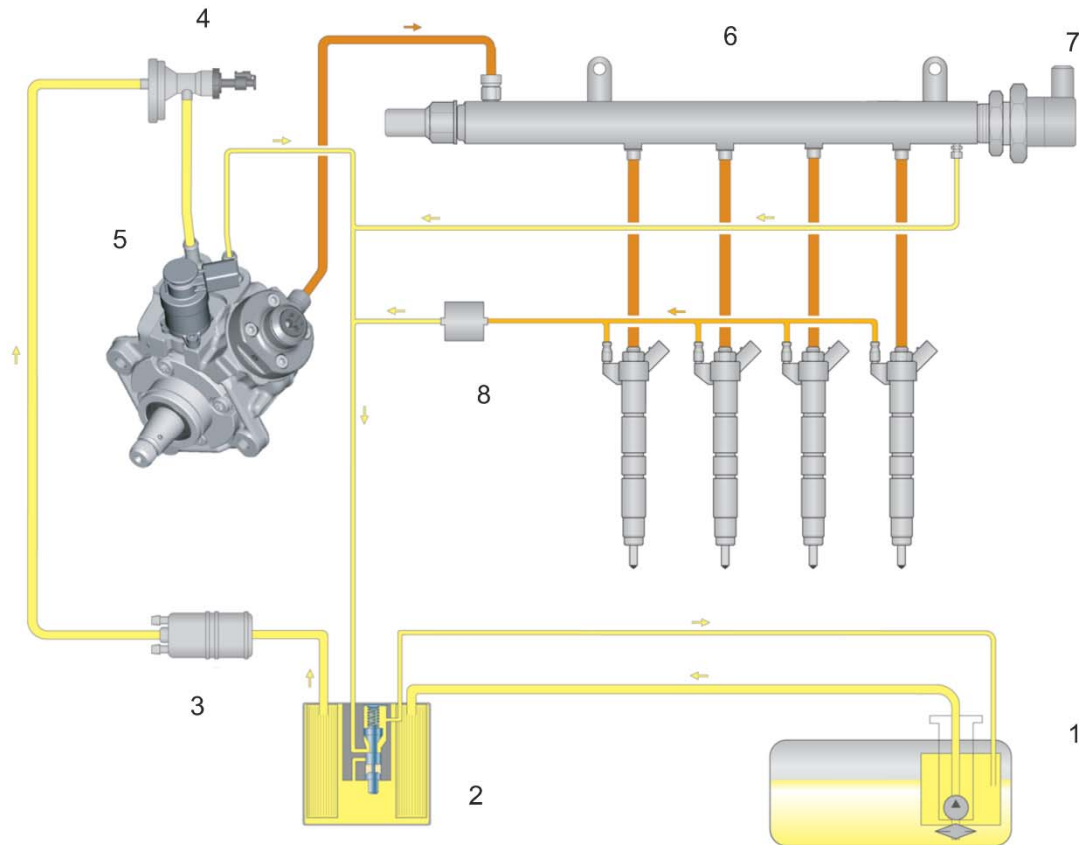

Figure 10. Fuel system [17]

2.1.6 Injection system

The common rail injection system is a high-pressure accumulator injection system for Diesel engines. The term “common rail“ refers to the shared fuel high-pressure accumulator for all fuel injectors in a cylinder bank.

In this type of injection system, pressure generation and fuel injection are performed separately. A separate high-pressure pump generates the high fuel pressure required for injection. It is then stored in the rail and supplied to the fuel injectors over short injection lines.

A high injection pressure up to a maximum of 1800 bar enables good mixture formation. It offers a flexible course of injection with multiple pre- and post-injections.

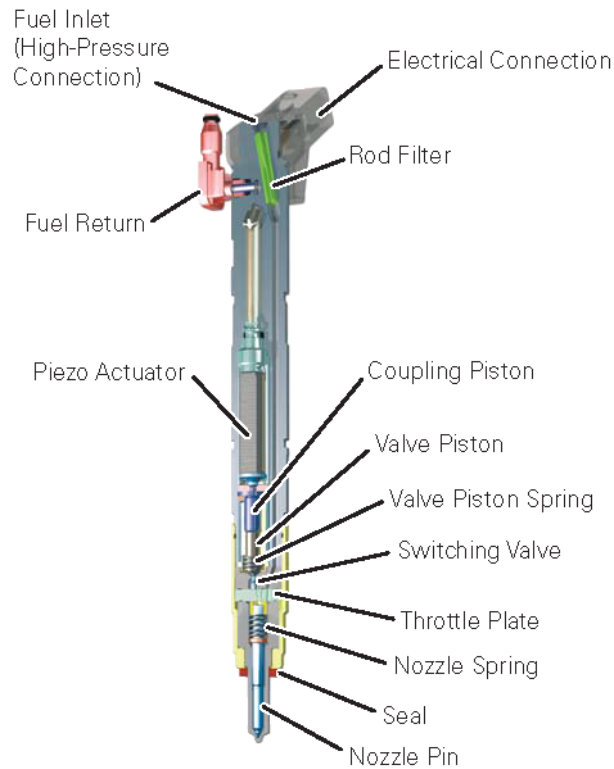

Figure 11. Fuel injector [17]

The fuel injectors are controlled over a piezo actuator. The switching speed of a piezo actuator is approximately four times faster than a solenoid valve. Compared to solenoid actuated fuel injectors, piezo technology also involves approximately 75% less moving mass at the nozzle pin. Due to the very short switching times of the piezo-controlled fuel injectors, it is possible to control the injection phases and quantities flexibly and precisely. This enables the course of injection to be adapted to the operating conditions of the engine. Up to five partial injections can be performed per course of injection. Schematics of the fuel injectors are given in Figure 11.

2.1.7 High-Pressure Fuel Pump

The high-pressure fuel pump, shown on Figure 12, is a single-piston pump. It is driven via the toothed belt by the crankshaft at engine speed. It has the job of generating the high fuel pressure of up to 1800 bar needed for injection.

Pressure is generated by the rotation of two cams offset by 180 degrees on the pump drive shaft. The injection is always in the operating cycle of the respective cylinder. This keeps the pump drive evenly loaded and pressure fluctuations in the high-pressure area are minimized.

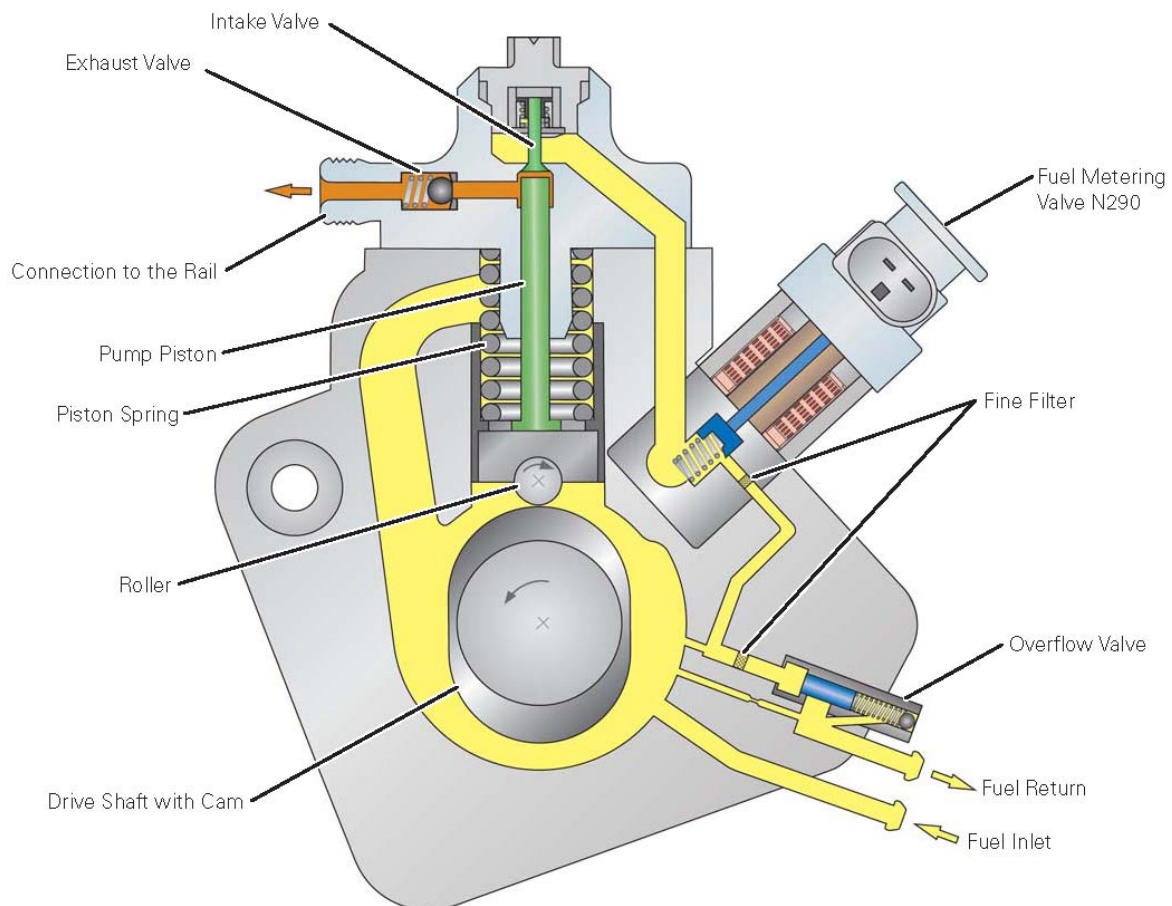

Figure 12. High-pressure fuel pump [17]

2.2 Experimental engine

The experimental engine, shown on Figure 13, is equipped with a direct and port fuel injection. Common rail direct injection system consists of an accumulator which is connected to the high pressure fuel pump. High pressure fuel lines also connect the accumulator to the injector of the first cylinder. Combustion takes place only in the first cylinder. Intake pipe, which is mounted on top of the intake channels of the first cylinder, is equipped with a port fuel injector that injects methane into the fill channel of the first cylinder. Other three cylinders have only an air filter on the intake channels.

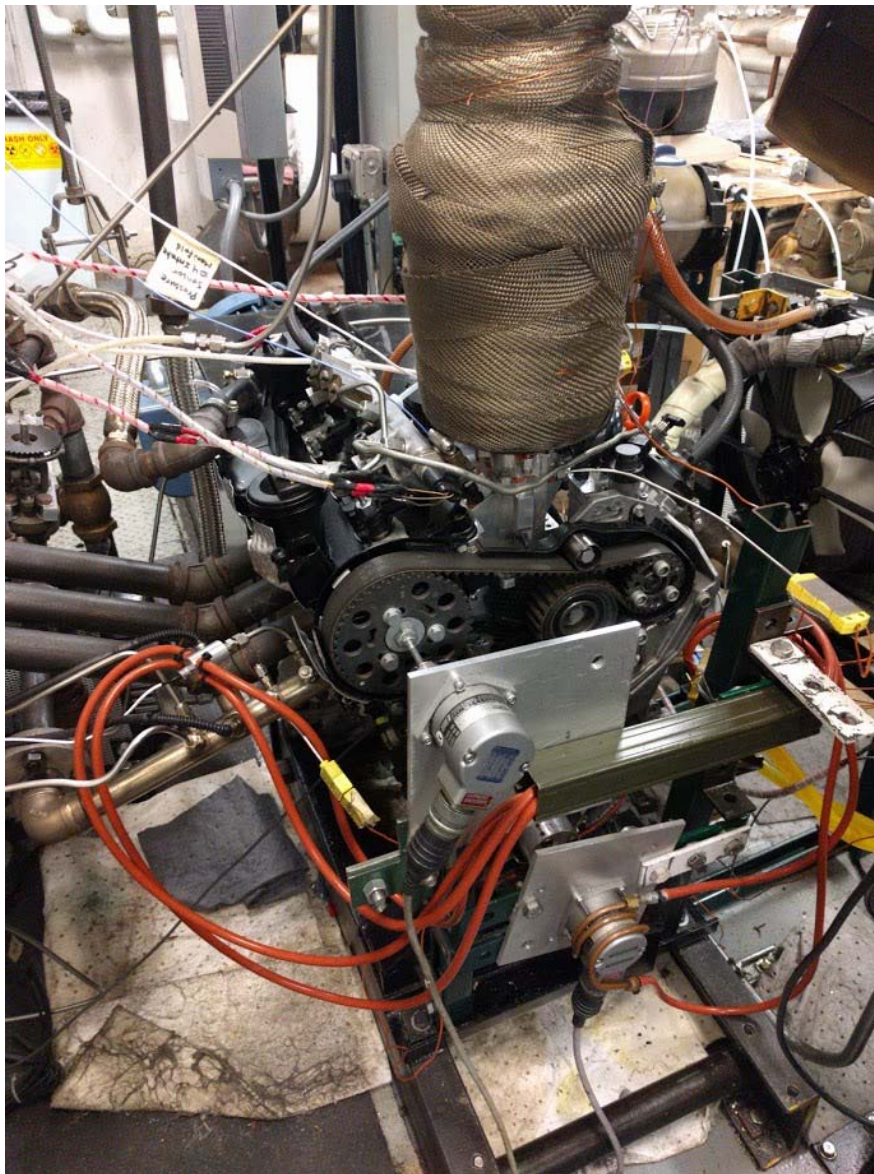

Figure 13. Experimental engine

Each cylinder has its own exhaust pipe. As the combustion only takes place in the first cylinder, its exhaust pipe is separated from the other exhaust pipes so that a sample of the exhaust gases can be sent to the exhaust gas analyzer and is not mixed by air passing through other non-firing cylinders.

Engine management is performed by National Instruments Direct Injector Driver which controls both direct and port fuel injection and by National Instruments LabVIEW code which is responsible for data acquisition and instrument control.

2.3 Modified direct fuel injection

As the high pressure fuel pump demands that the supplied fuel is at a pressure of 4 bar, auxiliary fuel pump is used on the original Diesel engine. However, due to the nature of this experimental engine, the auxiliary fuel pump is not mounted. Fuel tank is then filled with diesel fuel after which it is pressurized to the desired pressure using nitrogen gas from the nitrogen cylinder tank and the pressure is maintained by a pressure regulator. Fuel is then supplied under low pressure to the high pressure fuel pump. The majority of diesel fuel is pressurized in the high pressure fuel pump to high pressure and fed to the accumulator (common rail). A solenoid valve in the accumulator is responsible for maintaining the given pressure which varies from 250 bar to 1800 bar. When the injector, which is described in the previous chapter, receives the control signal, nozzles are opened and the fuel is supplied to the cylinder.

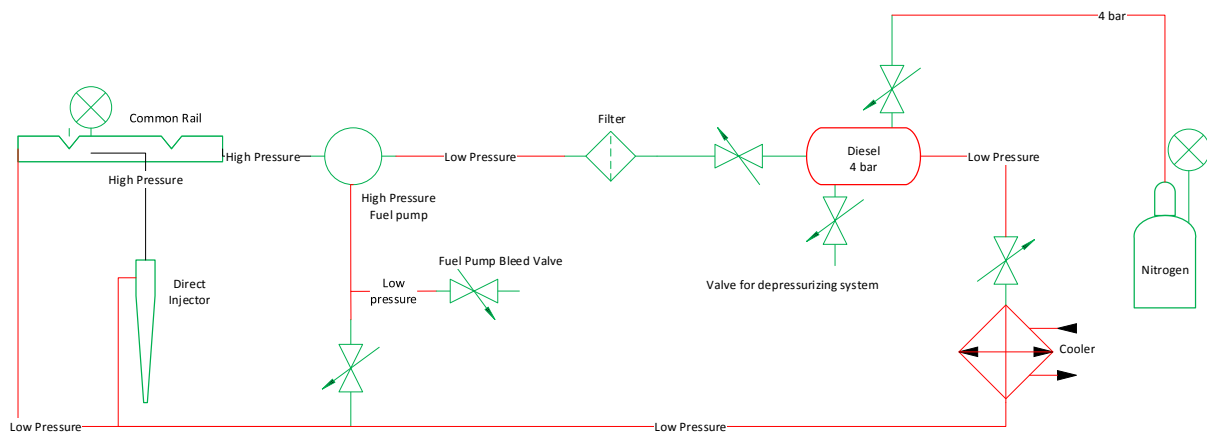

Figure 14. Direct fuel injection system

Return lines from the accumulator, injector and from the fuel pump are under low pressure of 4 bar and are mutually connected. The common return line then flows through the cooler so that normal diesel fuel operating temperature of around 30°C is maintained. Fuel is then returned to the tank.

Fuel pump bleed valve is used before operating the engine. By opening the bleed valve, diesel fuel is supplied to the fuel pump and excess air is blown out through the bleed valve. If that was not performed, the air bubbles could potentially cause major issues with the injector.

2.4 Modified port fuel injection

Port fuel injection system is shown of Figure 15. Methane is supplied from the methane cylinder tank which has a pressure regulator. Pressure under which methane is injected is 2.5 bar. Between the methane cylinder tank and the port fuel injector a Coriolis flow meter is connected and used for measurement of methane mass flow. The data from this flow meter is sent to the engine management.

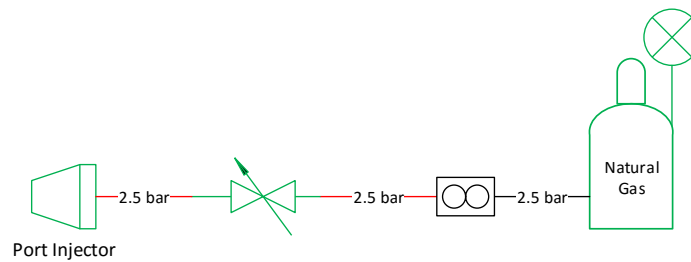

Figure 15. Port fuel injection system

The port fuel injector used is a gaseous injector called Peak & Hold Injector PQ2-3200, shown on Figure 16. With a maximum flow rate of 2 g/s at the pressure of 3 bar it is suitable for the required experiments.



Figure 16. Port fuel injector

2.5 Control system

2.5.1 National Instruments Direct Injector Driver

The NI Direct Injector Driver System, shown on Figure 17, features an NI CompactRIO controller, NI 9751 Direct Injector (DI) driver module and NI 9411 digital input module. The

system can synchronize injector channels with production crank/cam position sensors. The included DI driver module provides the power electronics necessary to drive high-power piezoelectric direct injectors.

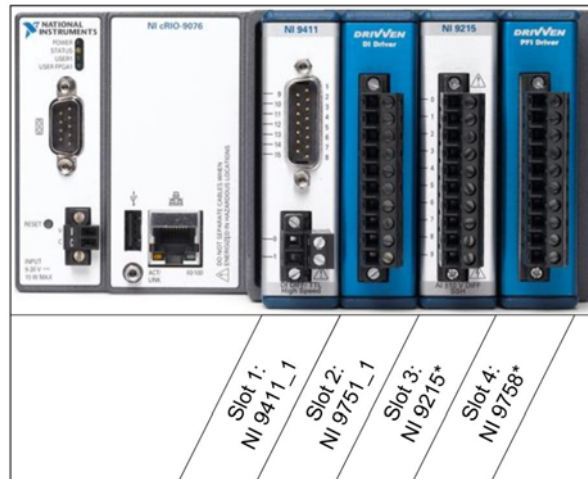

Figure 17. DI Driver System Configuration with optional NI 9215 and PFI driver [21]

Optional NI 9758 PFI driver module and NI 9215 analog input module, which the experimental setup is equipped with, are used to drive port fuel injectors and control common-rail fuel pressure, respectively. Modules used in the experimental setup are shown on Figure 18.

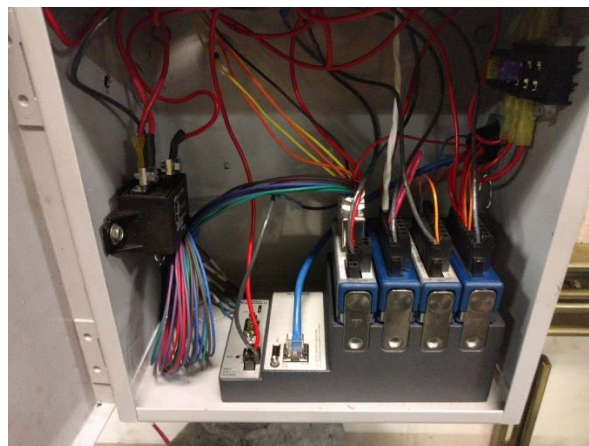

Figure 18. DI Driver System Configuration in the experimental setup

2.5.2 Direct fuel injection

Direct injectors have two pins or wire leads. Each DI Driver module has three channels and provides a positive and negative terminal for each channel. Piezoelectric injectors depend

on the correct polarity of connectors. Two injectors are supported, but only one is used in the experimental setup.

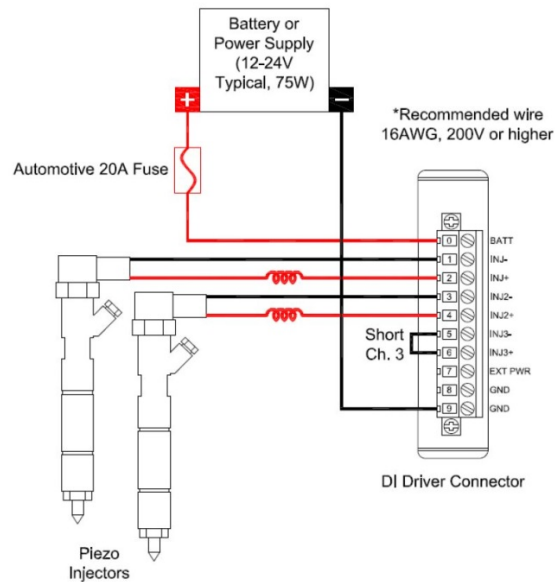

Figure 19. Diagram of typical wiring of piezo injectors to a DI Driver Module [21]

The possibilities of controlling the characteristics of direct injection can be seen on Figure 20. The injection can be defined by the start of injection or by the end of injection coupled with the duration of injection. For the purpose of this research, injection was defined by the start of injection (crank angle degrees before top dead center) coupled with different durations of injection. A total of 6 pulses per injection can be defined, but in this work only one injection pulse was used.

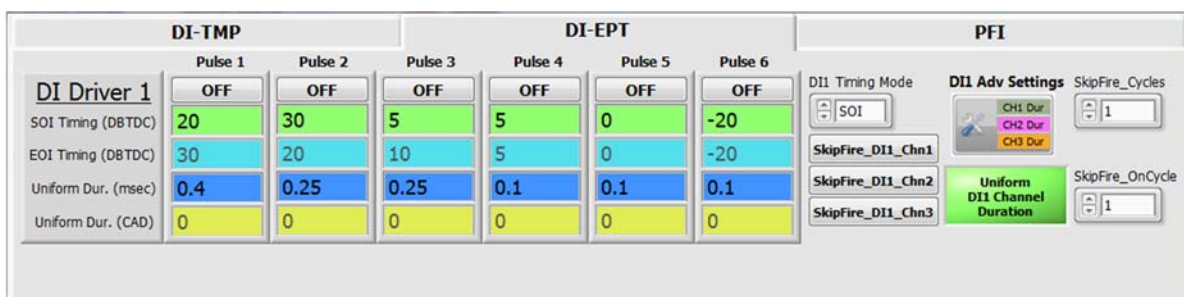

Figure 20. Direct injection control window

2.5.3 Port fuel injection

The PFI Driver module has four channels for driving port fuel injectors. Only one port fuel injector was used for the purpose of this experiment. Wiring diagram for up to four port fuel injectors to the PFI channels of the PFI Driver Module is shown in diagram on Figure 21.

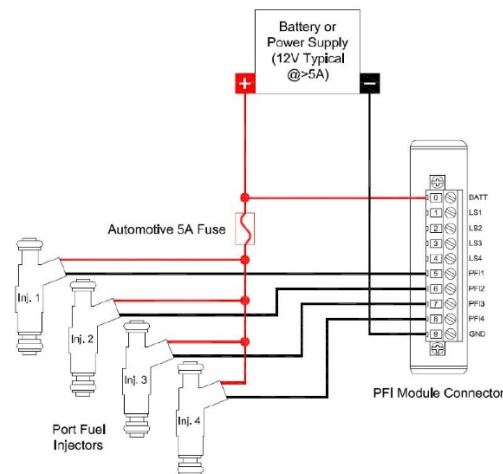

Figure 21. Diagram of typical wiring of port fuel injectors to a PFI Driver Module [21]

Control of port fuel injection can be seen on Figure 22. Injection timing must be defined in relation to the top dead center (TDC). In these experiments, injection timing was set to 400°CAD BTDC and the duration of injection varied from 0 ms to 19 ms.

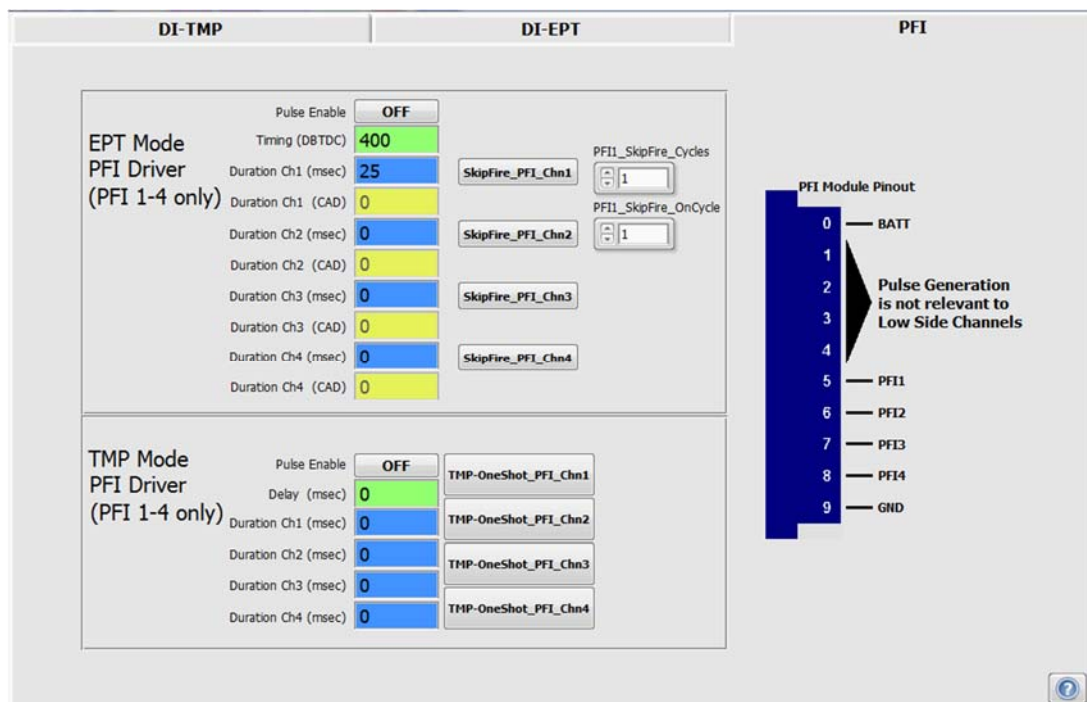

Figure 22. Port fuel injection control window

2.5.4 Common rail pressure

The DI Driver System supports a common rail pressure control feature. The high pressure fuel pump has an Inlet Metering Valve (IMV) which is a solenoid proportional valve that meters the fuel to the inlet of the pump. The IMV is controlled with a lowside driver channel via PWM operation. This common rail fuel system also has a High Pressure Valve (HPV) on the rail as a bleed valve to provide fuel flow through the system for stable pressure control. HPV is also a proportional solenoid valve controlled with a lowside driver channel via PWM operation.

The fuel rail has a pressure sensor connected to the end, providing analog pressure feedback to the NI 9215 analog input module for rail pressure PID control. The rail pressure PID control function generates a PWM duty cycle for the HPV to maintain a specified rail pressure setpoint.

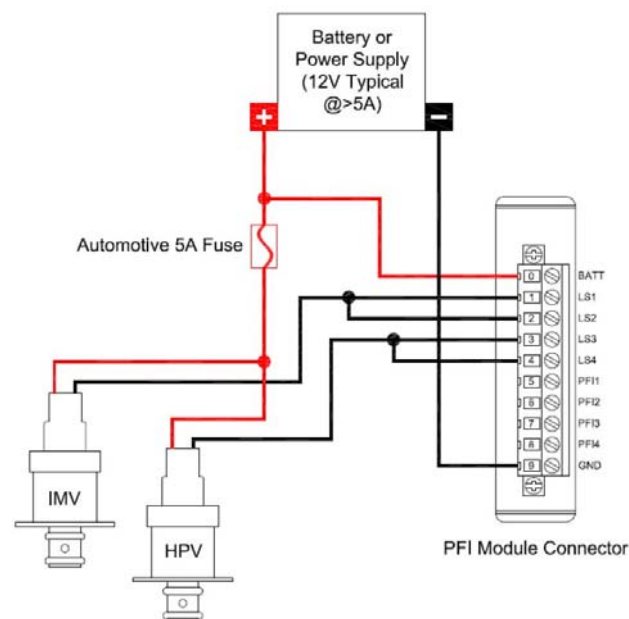

Figure 23. Diagram of typical wiring of an Inlet Metering Valve and a High Pressure Valve to a PFI Driver Module [21]

After the initial setup of the PID controllers, rail pressure is controlled with a single user-defined value. Rail pressure used in this research varied from 250 bar to 1000 bar.

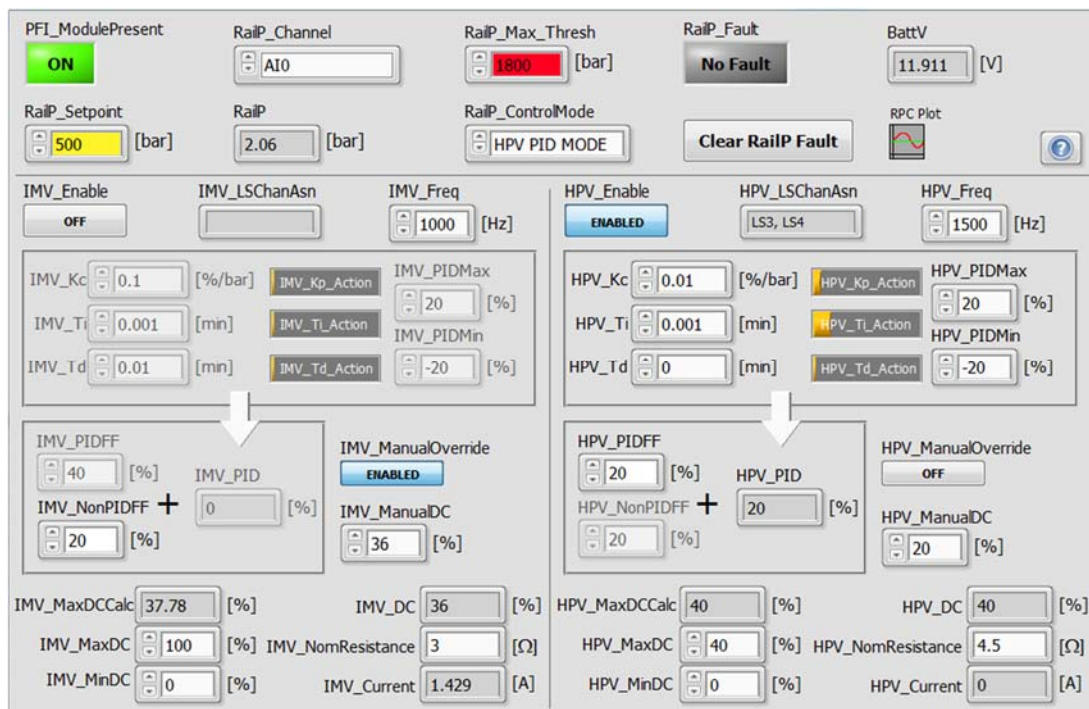

Figure 24. Rail Pressure Control Window

2.6 Data acquisition

2.6.1 Pressure sensor



Figure 25. Pressure sensor (left) with measurement cable (middle) a charge amplifier (right) [22]

Piezoelectric pressure sensor AVL GH14D operates on the principle of electrical charge output of certain crystals under mechanical load. In this case, the piezoelectric sensor measures the change in pressure so it is also known as a differential sensor. Output charge is proportional to the pressure applied. Due to the relatively low electrical charge output, the connection between the sensor and the charge amplifier is crucial. Therefore, high impedance measurement cable is used.

To allow effective signal processing the generated charge is converted to a voltage signal by means of a charge amplifier. The signal is then sent to the data acquisition unit. The previously described components are shown on Figure 24.

2.6.2 Mass flow meters

Air and methane flows are measured with the Micro Motion Coriolis flow meters, shown on Figure 26. Both of the Coriolis flow meters have current output, ranging from 4 mA to 20 mA. By connecting a resistor, voltage output is measured. Based on the existing calibration data, voltage is then recalculated in LabVIEW code to show actual air and methane flows.

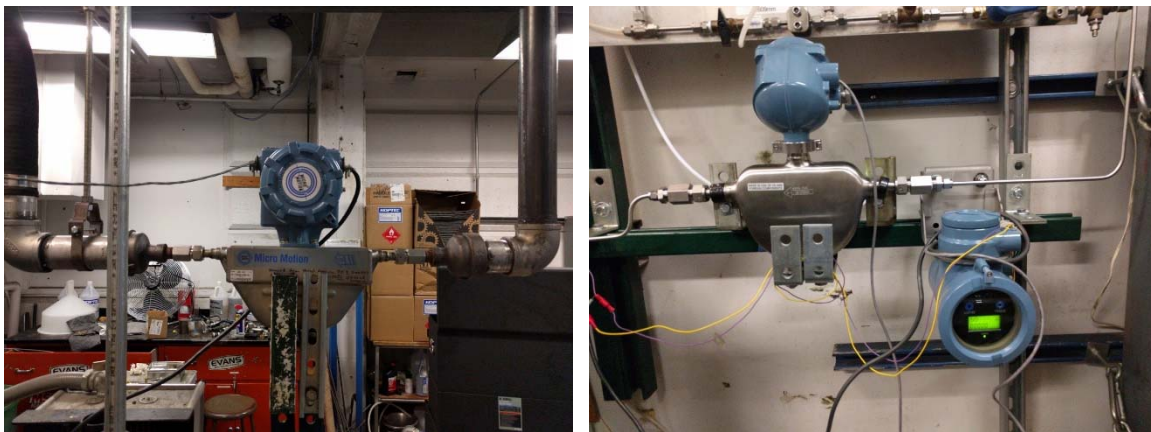

Figure 26. Air (left) and methane (right) flow meters

2.6.3 National Instruments LabVIEW

National instruments LabVIEW is a development environment designed with a graphical programming syntax that makes it simple to visualize, create and code engineering systems. In this work it is used to acquire and analyze measurement data and to control specific instruments.

LabVIEW is also used for data acquisition. For each operating point the in-cylinder pressure traces of 300 cycles are recorded with the resolution of 0.25°CA . Along with the pressure trace, a summary of engine parameters is recorded over the time frame of 60 s. Parameters which are included in the summary file are:

- engine speed,
- methane, air and diesel fuel mass flows,
- air-fuel equivalence ratios for diesel fuel, for gaseous fuel and combined

- diesel substitution ratio, energy based and mass based
- IMEP
- temperatures,
- etc.

On Figure 27, the control window used to monitor the experimental engine is shown. It can be used to show pressure trace (1), intake (2) and other (3) temperatures (such as oil, coolant, fuel, exhaust etc.), engine load in terms of IMEP (4), combustion phasing (CA50) (5), mass flows (6), air-fuel equivalence ratios (7), etc.

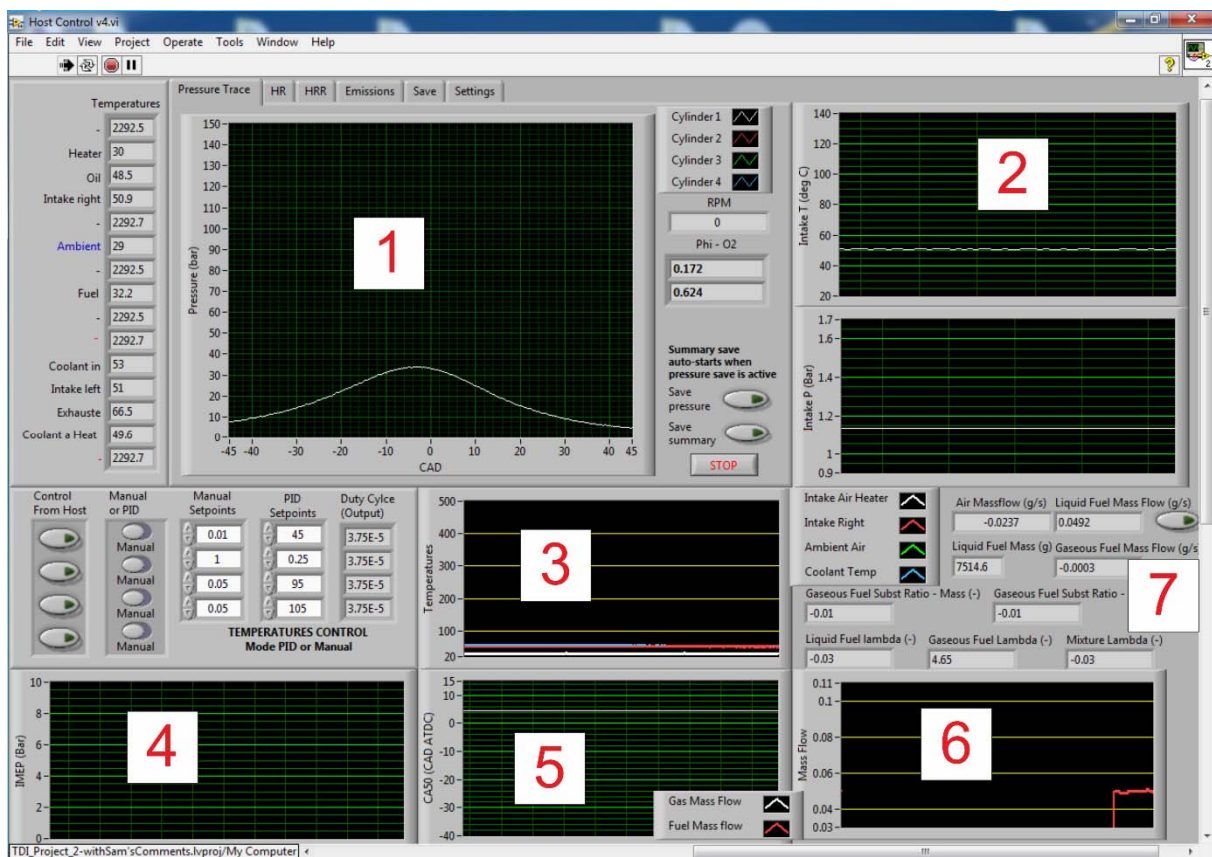

Figure 27. LabVIEW engine management window.

2.7 Exhaust gas analyzers

2.7.1 Measurement of HC

When a hydrocarbon is introduced into the hydrogen flame, the heat energy from combustion at the tip of the jet nozzle causes hydrocarbon to undergo ionization. If two electrodes are fitted on either side of the flame, and a DC voltage is applied between the two electrodes, this sets up a minute flow of ions which is proportional to the number of carbon atoms from the hydrocarbon. The current is converted to an electric voltage by a resistor and in this way the hydrocarbon is detected.

Measurements of hydrocarbon concentration taken using hydrogen flame ionization detector are not affected by the presence of inorganic gases such as CO, CO₂, H₂O, NO or NO₂ in the sample. However, changes in O₂ concentration do have an effect. The effect of this O₂ interference is very complex and varies according to many different factors.

Response to hydrocarbons is proportional to changes in concentration (number of carbon atoms) for a single hydrocarbon, but is not perfectly proportional to the number of carbon atoms in different hydrocarbons. This relative response of different hydrocarbons is called relative sensitivity.

The Horiba gas analyzer FIA-220, used in this work, is a flame ionization analyzer. It uses C₃H₈ (in air) as a reference for the relative sensitivity to different hydrocarbons. This allows accurate measurements to be made by keeping responses to within 5% for a range of hydrocarbons.

Measurements also change according to factors such as flow rate, fuel components, proportion of fuel component and detector structure (oxygen presence). [23]

2.7.2 Measurement of O₂

The Horiba gas analyzer MPA-220, used in this work, is a magneto-pneumatic analyzer used to measure the oxygen (O₂) concentration in a sample gas.

When an uneven magnetic field is applied to a paramagnetic gas, the gas is drawn towards the strongest part of the field, rising the pressure at that point. A gas which is not susceptible to magnetism (nitrogen) can be used to take the pressure rise out of the magnetic field.

If two electromagnets are excited alternately, the pressure changes can be converted into electrical signals by a condenser microphone. Output is linear in proportion to oxygen concentration. [23]

2.7.3 Measurement of CO and CO₂

The Horiba gas analyzer AIA-220, used in this work, is an infrared analyzer that uses non-dispersive infrared analysis to continuously measure the concentration of individual components of a sample gas.

A molecule consisting of different atoms absorbs infrared energy of specific wavelengths, and the degree of absorption is proportional to the concentration at constant pressure. The AIA-220 analyzer uses this phenomenon, and by measuring the infrared absorption of the component of the gas to be measured, can continuously detect concentration changes in that component.

If the sample gas contains components which absorb infrared wavelengths which partially overlap with those absorbed by the component to be measured, a solid state filter can be used to remove overlapping wavelengths in advance so that they do not affect the measurements. [24]

2.7.4 NO Determination

The Horiba gas analyzer CLA-220 is an atmospheric pressure type NO_x analyzer utilizing silicon photodiodes next to the reaction chamber to sense the chemiluminescent reaction.

The chemiluminescent method of detection of nitric oxide (NO) is based on the reaction of NO with ozone (O₃) to produce nitrogen dioxide (NO₂) and oxygen (O₂). About 10% of the NO₂ molecules produced are initially in an electronically excited state (NO₂⁺). These revert immediately to the non-excited state, accompanied by emission of photons. The reactions are:



where:

h = Planck's constant,

ν = Frequency, Hz.

When NO and O₃ mix in the reaction chamber, the chemiluminescent reaction produces light emission that is directly proportional to the concentration of NO. This emission is sensed by silicon photodiodes and amplified by the associated electronic circuitry. [25]

2.7.5 NO_x determination

The NO_x determination is identical to the NO determination except that, prior to entry into the reaction chamber, the sample is routed through a converter where the NO₂ component is dissociated to form NO. The reaction is:



Analyzer response is proportional to the total NO in the converted sample. Total NO is the sum of the NO originally present in the sample plus the NO resulting from dissociation of NO₂. The combination of NO and NO₂ is commonly designated NO_x. [25]

3 Research plan

3.1 Design of Experiments

As it was previously mentioned, for each operating point 300 cycles were recorded. The engine was run at the two different engine speeds, with the intake pressure set to atmospheric conditions of 1 bar.

Experimental plan was made to investigate the influences of the mass of injected diesel fuel, of injection timing and of injection pressure on engine performance at low, medium and high load. Engine performance was assessed through efficiency, emissions and combustion stability. Engine operating parameters are summarized below:

- Engine speed: 1000, 1800 rpm
- Intake pressure: 1 bar
- Injection pressure: 250, 500, 750, 1000 bar
- Injection timing: 40, 30, 20, 10° BTDC
- Diesel fuel mass flow: 0.015, 0.03, 0.047, 0.06, 0.075, 0.085 g/s.

Methane is injected at injection pressure of 2.5 bar and with the injection timing of 400° BTDC.

Each injection pressure is coupled with three different injection timings, each of which has three different injected diesel fuel mass flows. For every diesel fuel mass flow, diesel combustion is formed after which port injection of methane is established. Three dual fuel operating points are then recorded.

With all operating parameters set (injection pressure, diesel fuel mass, diesel fuel injection timing and engine speed), load was controlled by the methane mass (methane injection duration). Higher methane concentration implies lower fuel-air equivalence ratio, which means higher engine load. Three different loads were studied for each set of engine parameters, low load of 2 bar IMEP, mid load of 5 bar IMEPg and high load of maximum achievable IMEP which varied from 6 to 8 bar IMEP. Example of different pressure curves with different diesel substitution rates is show in Figure 28.

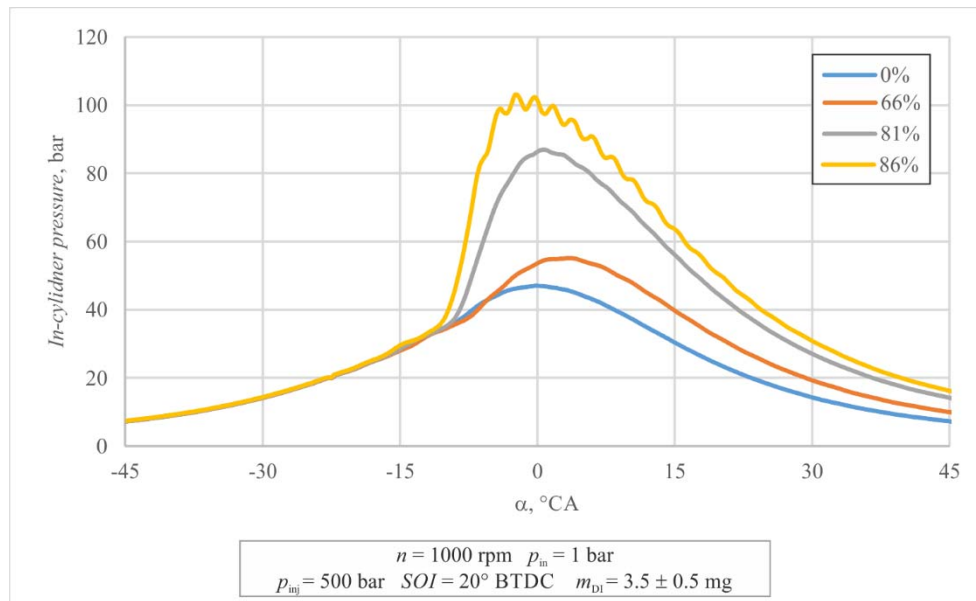

Figure 28. In-cylinder pressure for loads with different percentages of diesel substitution rate

3.2 Engine Performance Calculation

Pressure trace is obtained with the experiments, after which engine parameters can be calculated. Indicated engine efficiency is calculated from the pressure trace of each operating point. As it is known, indicated engine efficiency equals to the ratio of the indicated work output of the engine and the input of energy from fuel:

$$\eta_i = \frac{W_i}{Q_1} \quad (3.1)$$

where: η_i – indicated efficiency,
 W_i [J] – indicated work,
 Q_1 [J] – energy provided by the fuel.

Energy input is the sum of input energy of diesel fuel and methane which is calculated by dividing the product of mass flows and net calorific values of diesel and methane with the number of cycles per second:

$$Q_1 = \frac{\dot{m}_{\text{CH}_4} \cdot H_{\text{D,CH}_4} + \dot{m}_{\text{DI}} \cdot H_{\text{D,DI}}}{\frac{n}{2 \cdot 60}} \quad (3.2)$$

Indicated work, or the work done by the gas on the piston, is defined as:

$$W_i = \int p dV. \quad (3.3)$$

Indicated mean effective pressure (IMEP) is a measure of the indicated work output per unit of swept volume, a parameter independent of the size and number of cylinders in the engine and engine speed. IMEP is defined as:

$$IMEP = \frac{W_i}{V_s}. \quad (3.4)$$

where: V_s [m³] – cylinder volume.

Coefficient of variation (CoV) of IMEP has proven useful in evaluating combustion stability and is defined as:

$$CoV(IMEP) = \frac{\sqrt{\frac{\sum_1^N (IMEP - IMEP_m)^2}{N}}}{IMEP_m}. \quad (3.5)$$

where: $IMEP$ [bar] – indicated mean effective pressure,

$IMEP_m$ [bar] – mean IMEP of N cycles,

N – number of cycles.

To study only the combustion process without the gas exchange phase, gross indicated mean effective pressure (IMEPg) and gross indicated efficiency is calculated from the in-cylinder pressure over compression and expansion portion of the engine cycle, i.e. between the intake valve closure and the exhaust valve opening timings. Coefficient of variation of IMEPg is also calculated by using equation (4.6) and the appropriate mean effective pressures.

4 RESULTS

Operating points are summarized in Table 2:

Table 2. Operating points

No.	Target IMEP	Engine speed	Diesel mass	Intake pressure	Injection pressure	Injection timing
/	bar	rpm	g	bar	bar	°CA BTDC
Effect of diesel fuel mass						
1	2	1000	1.59	1	500	20
2	2	1000	3.05	1	500	20
3	2	1000	5.71	1	500	20
4	5	1000	1.69	1	500	20
5	5	1000	3.38	1	500	20
6	5	1000	6.39	1	500	20
7	max	1000	1.40	1	500	20
8	max	1000	3.22	1	500	20
9	max	1000	6.05	1	500	20
Effect of injection timing						
1	2	1000	3.27	1	500	30
2	2	1000	3.05	1	500	20
3	2	1000	3.94	1	500	10
4	5	1000	2.90	1	500	30
5	5	1000	3.38	1	500	20
6	5	1000	4.42	1	500	10
7	max	1000	3.23	1	500	30
8	max	1000	3.22	1	500	20
9	max	1000	4.08	1	500	10
Effect of injection pressure						
1	2	1000	3.51	1	250	20
2	2	1000	3.05	1	500	20
3	2	1000	2.12	1	750	20
4	5	1000	3.89	1	250	20
5	5	1000	3.38	1	500	20
6	5	1000	2.92	1	750	20
7	max	1000	4.18	1	250	20
8	max	1000	3.22	1	500	20
9	max	1000	3.09	1	750	20

Effect of engine speed						
1	2	1000	5.33	1	500	30
2	5	1000	5.76	1	500	30
3	max	1000	5.22	1	500	30
4	2	1000	5.71	1	500	20
5	5	1000	6.39	1	500	20
6	max	1000	6.05	1	500	20
7	2	1000	5.14	1	750	30
8	5	1000	5.01	1	750	30
9	max	1000	3.97	1	750	30
10	2	1800	5.48	1	500	30
11	5	1800	5.29	1	500	30
12	max	1800	5.22	1	500	30
13	2	1800	5.57	1	500	20
14	5	1800	5.47	1	500	20
15	max	1800	5.43	1	500	20
16	2	1800	5.00	1	750	30
17	5	1800	5.06	1	750	30
18	max	1800	4.88	1	750	30

4.1 Effect of diesel fuel mass

With all other engine parameters fixed, the effect of three different diesel fuel mass levels has been investigated. For each condition the amount of methane was changed and used to control the engine load. Equivalence ratios can be seen on Figure 29. In-cylinder pressure waves, which can be seen on Figures 30, 31 and 32, cause additional stress on the engine and therefore should be kept at minimum. This phenomenon occurs when the majority of heat released occurs in the initial phase of combustion. When the amount of diesel fuel increases, pressure rise rate increases, causing higher amplitudes of the in-cylinder pressure waves. Ultimately, this means that the maximum achievable IMEP_g decreases as the amount of diesel fuel increases, under the same start of injection conditions, which can be seen on Figure 33.

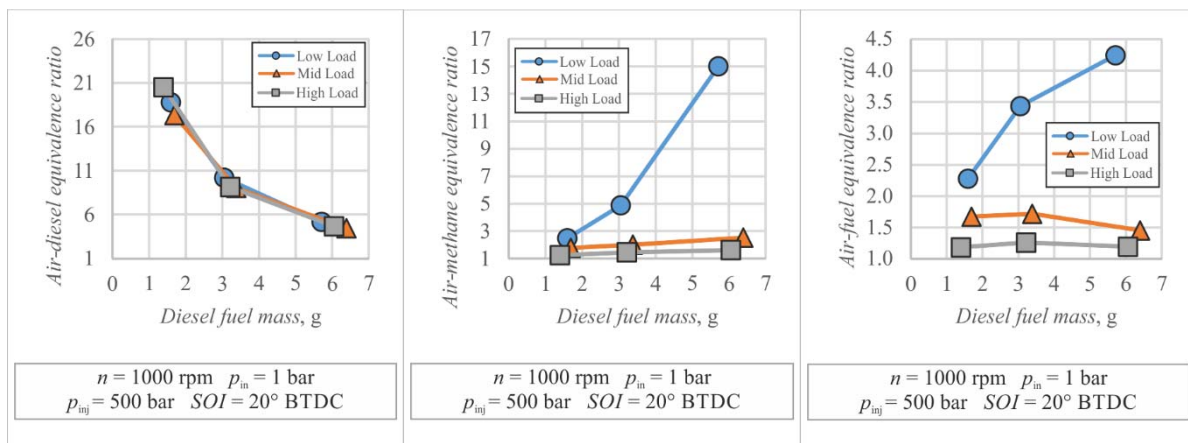

Figure 29. Change in equivalence ratios with the change of diesel fuel mass

As can be seen on Figures 30, 31 and 32, the increase of diesel fuel, implying the decrease of diesel substitution rate, causes faster reaction rate and by that a higher pressure rise rate. If the autoignition of diesel fuel occurs too soon, a significant part of combustion will occur before TDC. This means that the heat losses will be greater. This leads to lower indicated efficiency, which can be seen on Figure 34. Indicated efficiency at low load with low diesel fuel is very low due to misfiring and combustion instability, which can be seen by studying CoV at Figure 34. Increase of diesel fuel causes an increase in indicated efficiency at low load because the combustion improves. Low amount of diesel fuel is insufficient to ignite, so the increase of air-diesel equivalence ratio increases the reaction rate. Furthermore, indicated efficiency with high diesel fuel at low load is slightly higher than that of mid and high load due to the lower concentration of methane. Longer ignition delay and reduced flame speed compared to higher loads cause lower heat losses because the combustion occurs in the expansion stroke. Ultimately, this causes the previously mentioned increase.

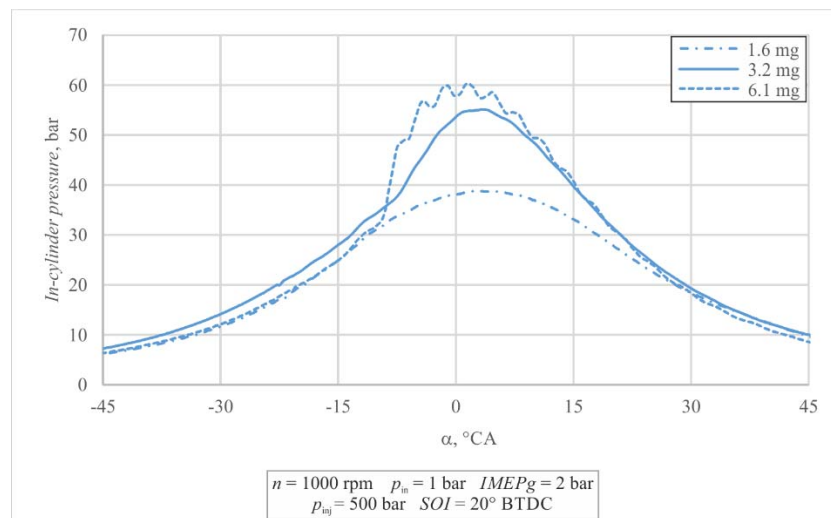

Figure 30. Effect of diesel fuel mass on in-cylinder pressure at low load

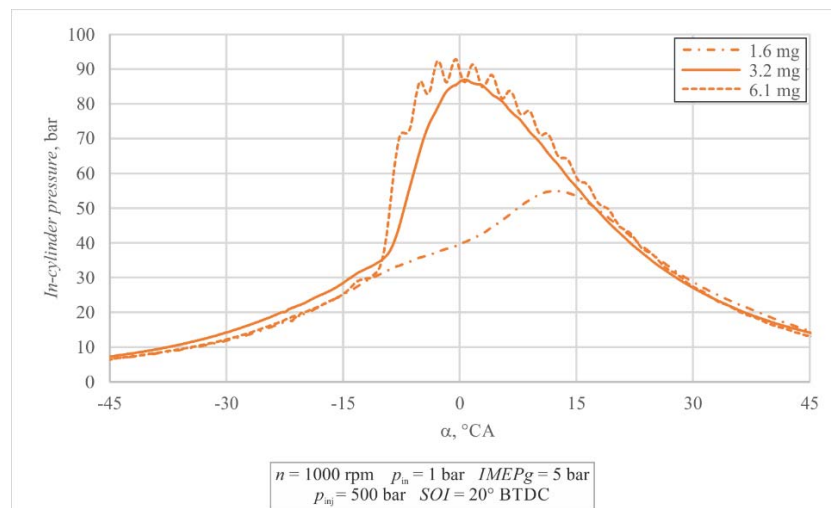

Figure 31. Effect of diesel fuel mass on in-cylinder pressure at mid load

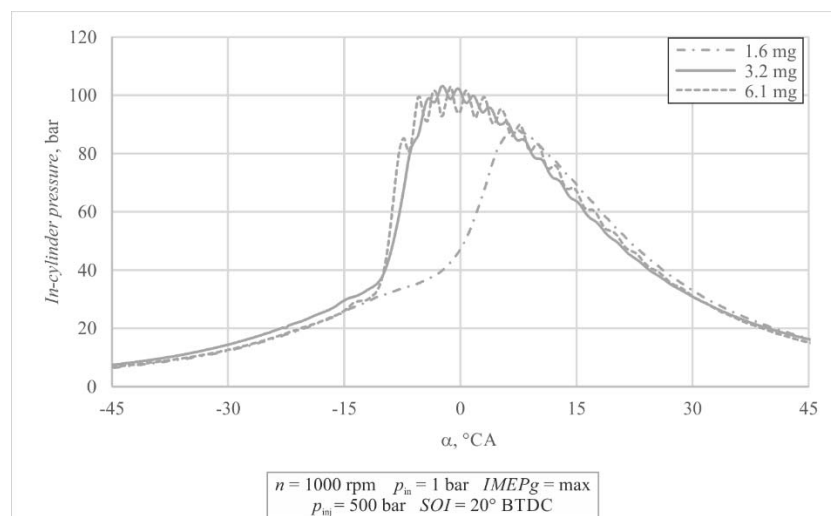

Figure 32. Effect of diesel fuel mass on in-cylinder pressure at high load

Only slight variations of CoV can be seen for mid and high load, but optimum diesel fuel quantity in terms of CoV can be determined. However, optimum operating point in terms of CoV doesn't imply the best overall efficiency, only the most stable combustion.

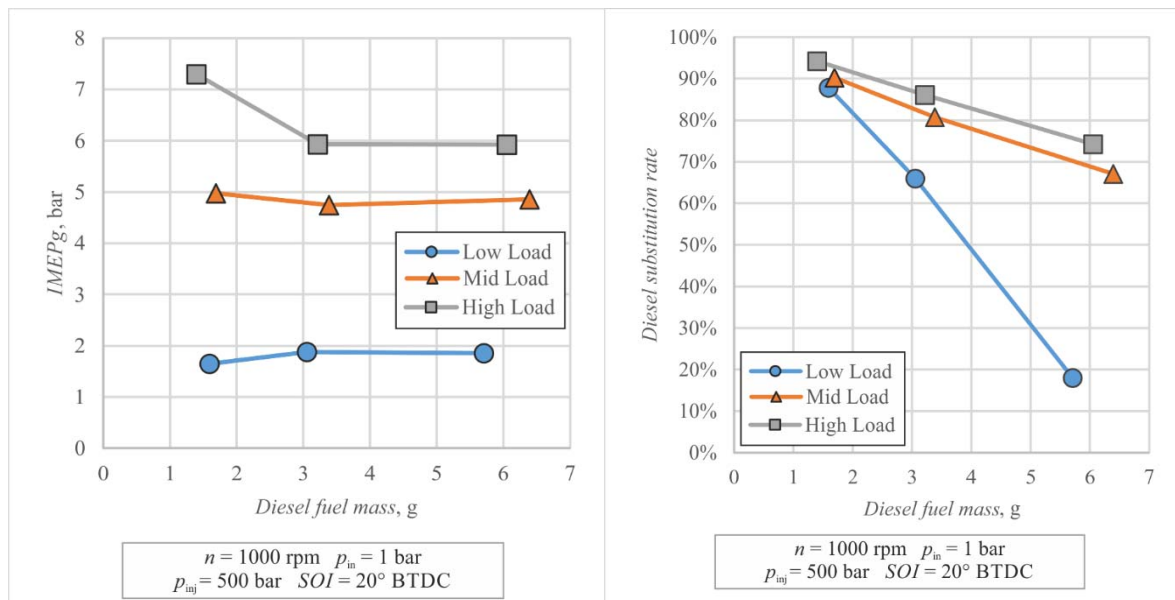

Figure 33. Effect of diesel fuel mass on IMEPg (left) and diesel substitution rate (right)

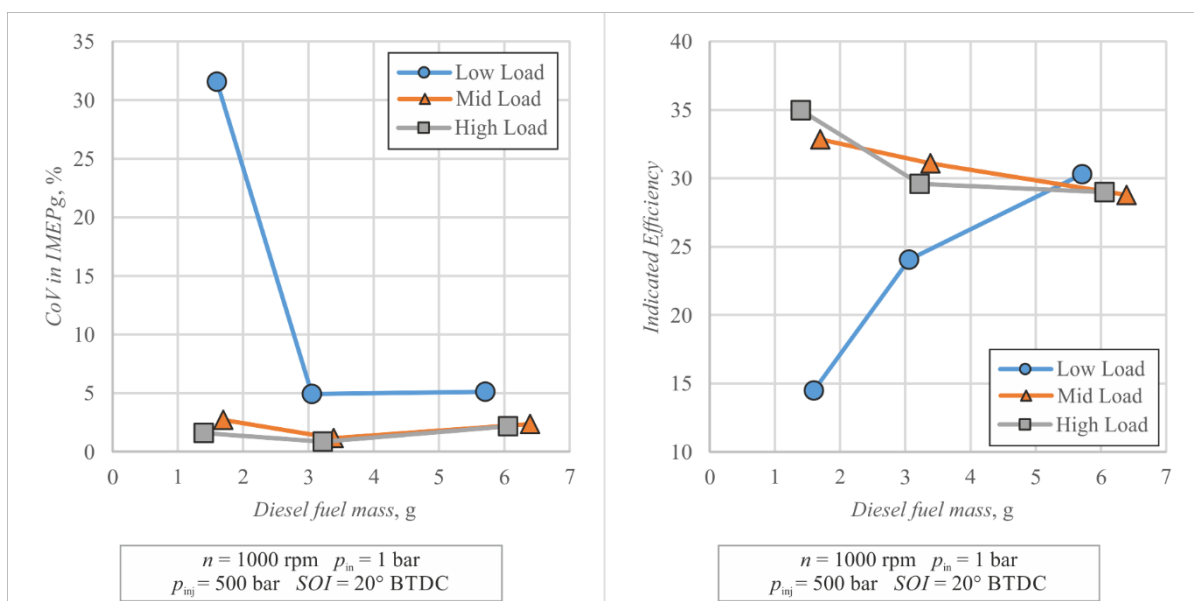

Figure 34. Effect of diesel fuel mass on CoV in IMEPg (left) and indicated efficiency (right)

At low load, due to the higher fraction of air inside the cylinder, the combustion temperature is low. This leads to incomplete combustion because of high equivalence ratios. Local quenching then becomes the main source of high HC emissions, especially at low diesel injection quantity because of the lower reaction rate. With low diesel injection quantity short

ignition delay cannot be achieved because the fuel zones are too lean. Diesel fuel is then leaned out and loses its purpose, so the methane doesn't ignite. With high diesel injection quantity ignition delay is considerably shorter. After the successful ignition of the diesel fuel, the flame propagation throughout the cylinder is better compared to low diesel fuel amount. This implies lower HC emissions.

If only high amount of diesel injection is studied, an increase of HC emission with the increase of engine load can be seen on Figure 35. At low load, diesel substitution rate is low which implies lower combustion rate. This means that the fuel has enough time to lean out and overly mix. Due to high diesel fuel fuel-air equivalence ratio, even the low methane concentration is enough to ensure proper combustion. As the engine load rises, due to the higher methane concentrations, methane gets trapped inside the crevices where it cannot burn. This leads to a rise in HC emissions. However, this is not the case on low and mid diesel fuel quantities because of the lower diesel fuel fuel-air equivalence ratio. Lower diesel substitution rate and leaning out of diesel fuel that occur with the decrease of engine load cause flame quenching and incomplete combustion. This leads to an increase of HC emissions.

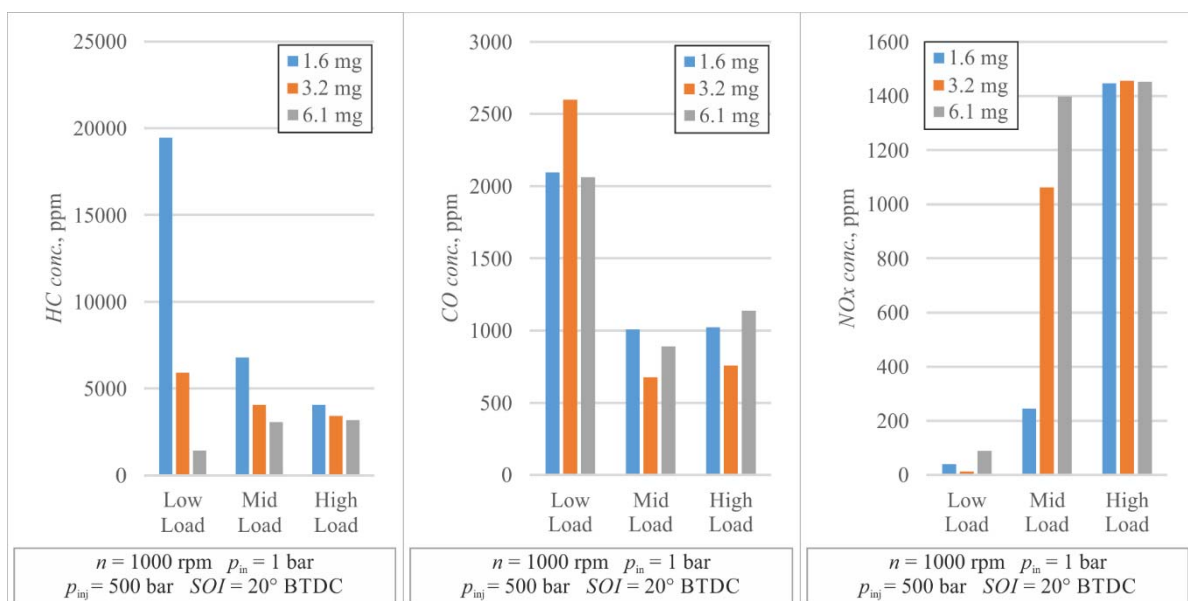

Figure 35. Effect of diesel fuel mass on HC (left), CO (middle) and NO_x (right) emissions

At low load, CO emissions are higher. The reason for that can be found in combustion instability and local quenching which cause only partial oxidation. As the gaseous fuel utilization improves on higher loads, CO emissions decrease. Figure 35 clearly shows that there is optimum diesel fuel quantity on mid and high load in terms of lowering CO emissions. Low

amount of diesel fuel causes implies low in-cylinder temperatures. Because of the low in-cylinder temperatures, only partial oxidation is achieved so the formation of CO₂ from CO doesn't occur. At high diesel fuel injection quantities, there is a localized lack of oxygen in the cylinder after combustion which causes the failure of oxidizing CO to CO₂.

At low loads, in-cylinder temperature is low so there are no conditions for NO_x to be formed. Increasing engine load causes the temperature to increase so the NO_x start to form. Similar effect can be seen at mid load, where the higher diesel fuel quantity increases the heat release rate and consequently the in-cylinder temperature. By that the NO_x emissions increase significantly. At high load, because the in-cylinder temperatures are already high, rise of diesel fuel quantity doesn't have an effect on HC emissions.

4.2 Effect of injection timing

An effort has been made to keep the mass of injected diesel fuel constant at 3.5 mg. For all operating points average mass of injected diesel fuel was 3.5 mg with a standard deviation of 0.5 mg. Three different injection timings have been studied. For each injection timing diesel substitution rate was gradually increased to achieve low load of 2 bar, mid load of 5 bar and high load of 6 bar. Equivalence ratios can be seen on Figure 36.

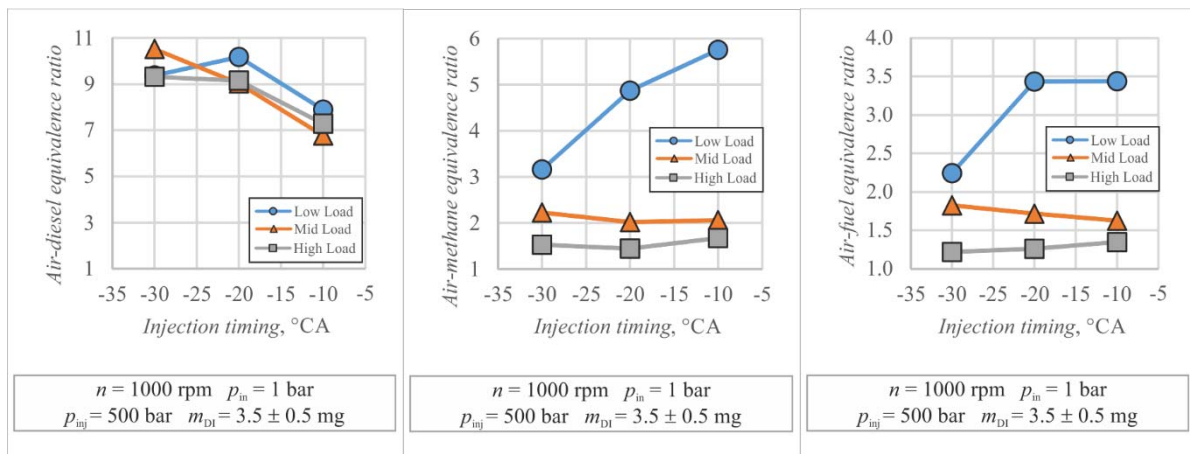

Figure 36. Change in equivalence ratios with the change of injection timing

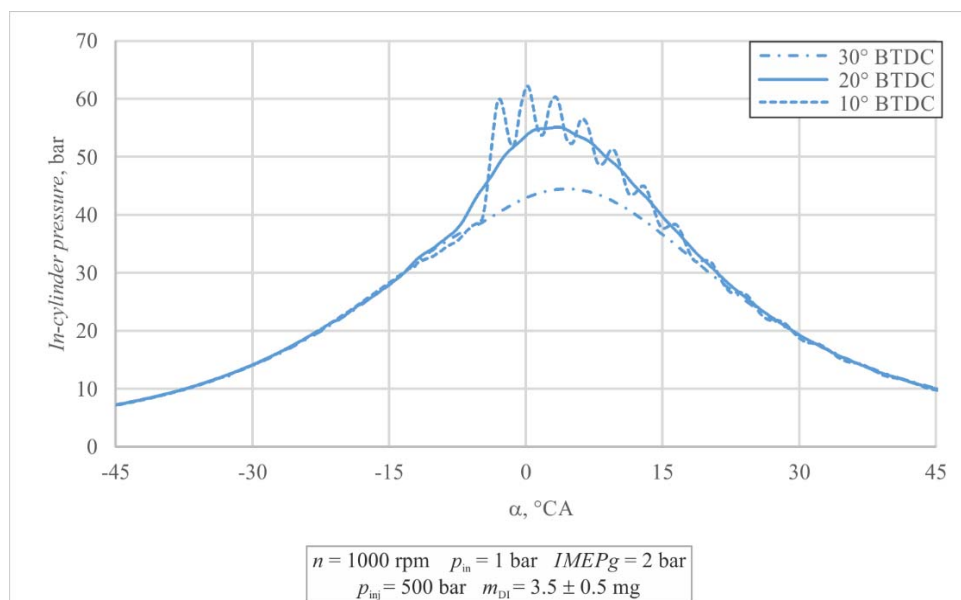

Figure 37. Effect of injection timing on in-cylinder pressure at low load

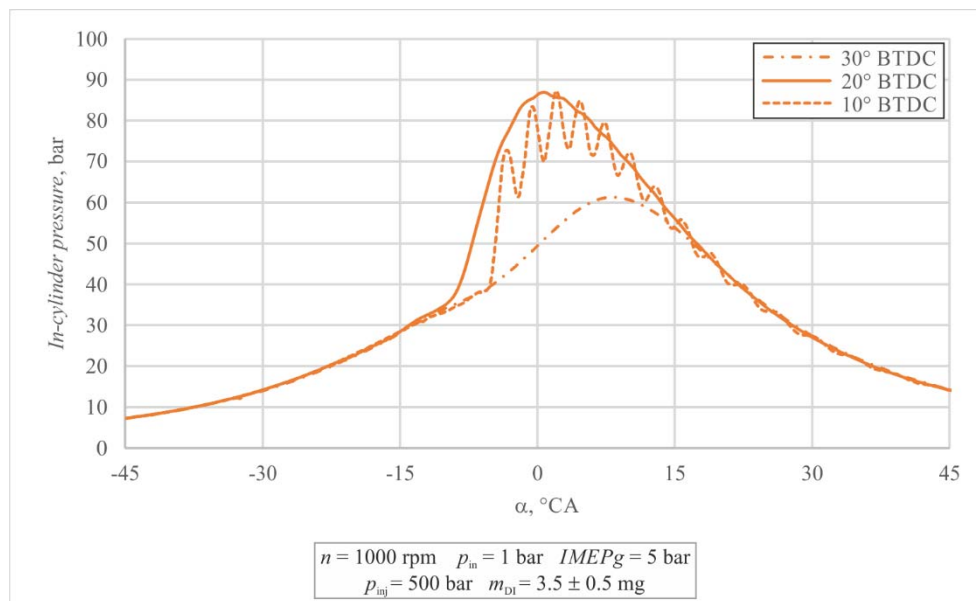

Figure 38. Effect of injection timing on in-cylinder pressure at mid load

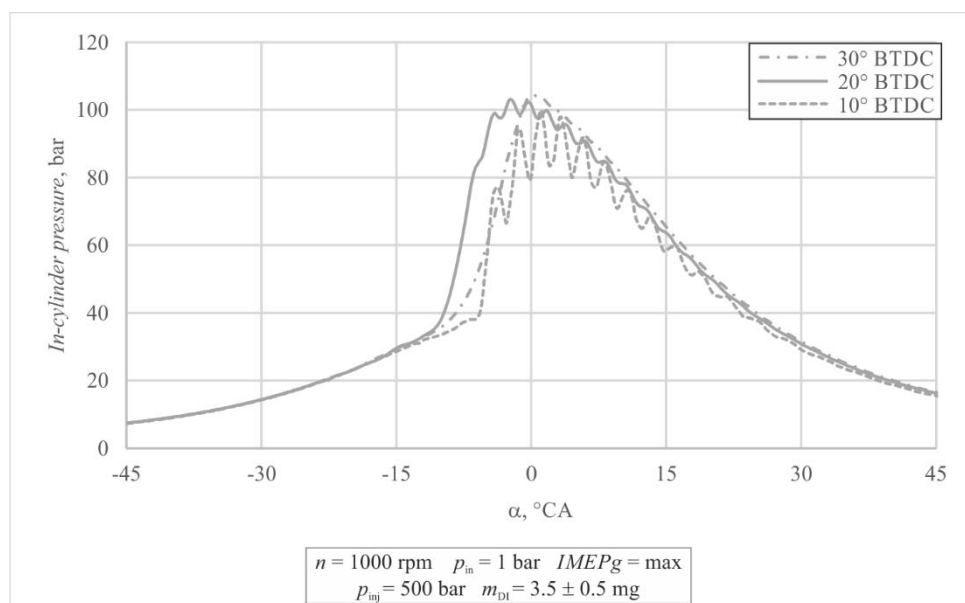

Figure 39. Effect of injection timing on in-cylinder pressure at high load

As can be seen at Figures 37, 38 and 39, injection timing of 10° BTDC causes high tendency to form in-cylinder pressure waves. Advancing injection timing to 20° BTDC causes lower reaction rate and by that lower pressure rise rate. This occurs because diesel fuel is injected at lower compression temperatures. Therefore, ignition delay of diesel fuel is longer. Further advance causes diesel fuel to overmix because it is injected at too low temperatures for auto-ignition. Proper combustion at 30° BTDC occurs only on high load.

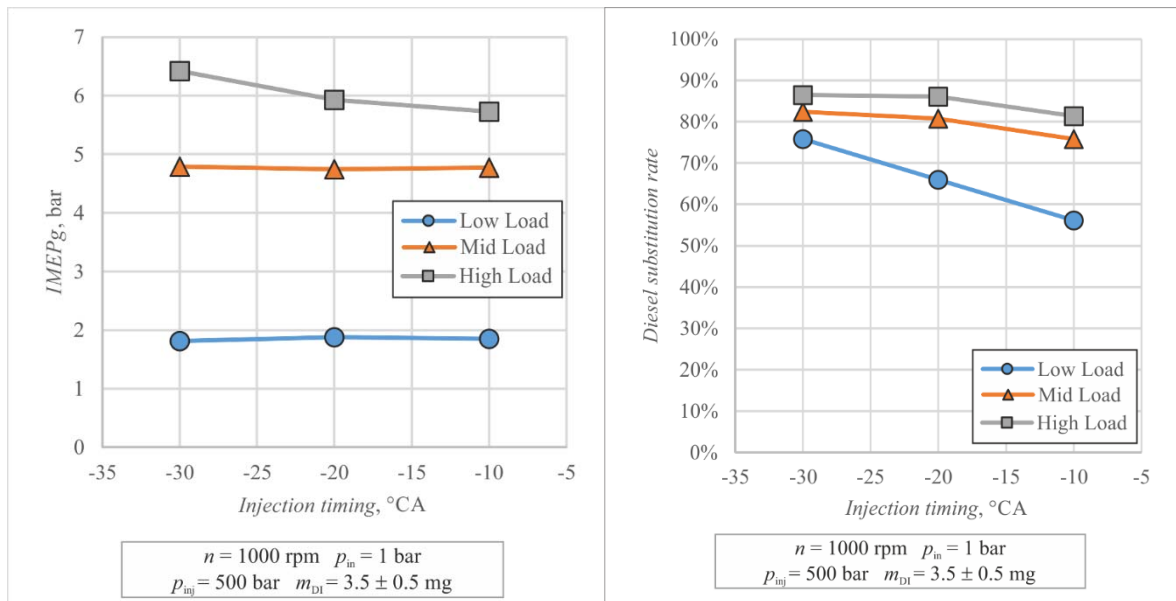

Figure 40. Effect of injection timing on IMEPg (left) and diesel substitution rate (right)

As diesel injection timing advances, tendency to form in-cylinder pressure waves decreases. This occurs because diesel fuel is injected into lower temperatures and by that, its reaction rate decreases. Because of that, closer to stoichiometric fuel-air equivalence ratio can be achieved by adding more methane. This leads to higher maximum achievable IMEPg, which can be seen on Figure 40.

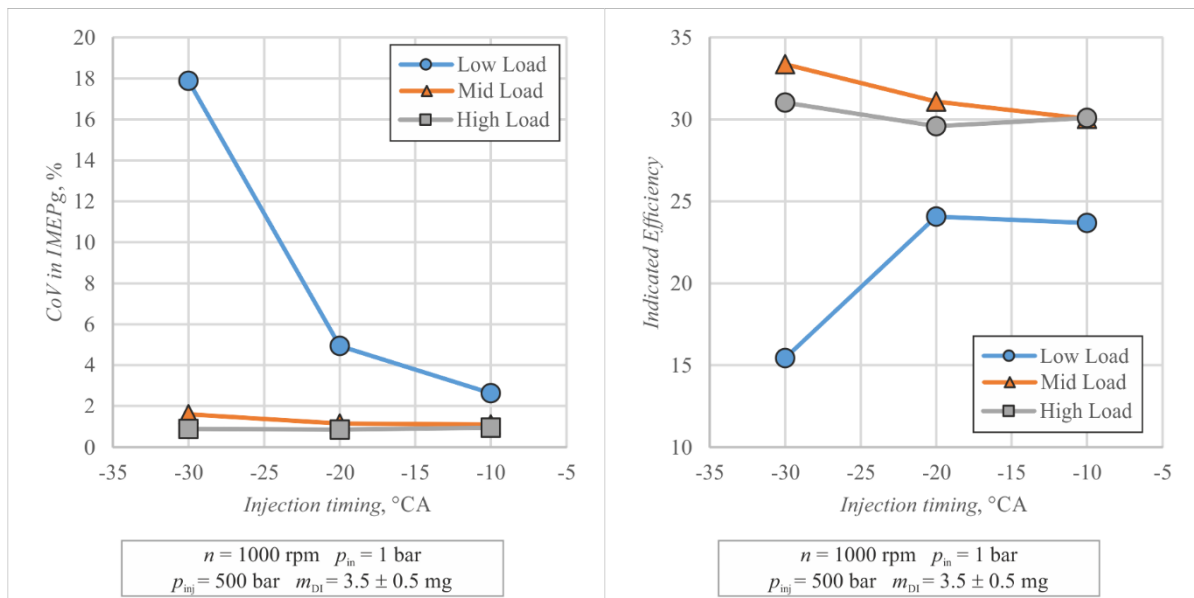

Figure 41. Effect of injection timing on CoV in IMEPg (left) and indicated efficiency (right)

At mid and high load, indicated efficiency is highest at 30° BTDC, where the heat losses are smaller. At low load, combustion does not occur, implying low indicated efficiency. This is

confirmed by studying CoV in IMEPg on Figure 41. Retardation of injection timing from 30° to 20° BTDC causes an increase in indicated efficiency. This happens because the temperatures inside the cylinder are greater so combustion starts to occur.

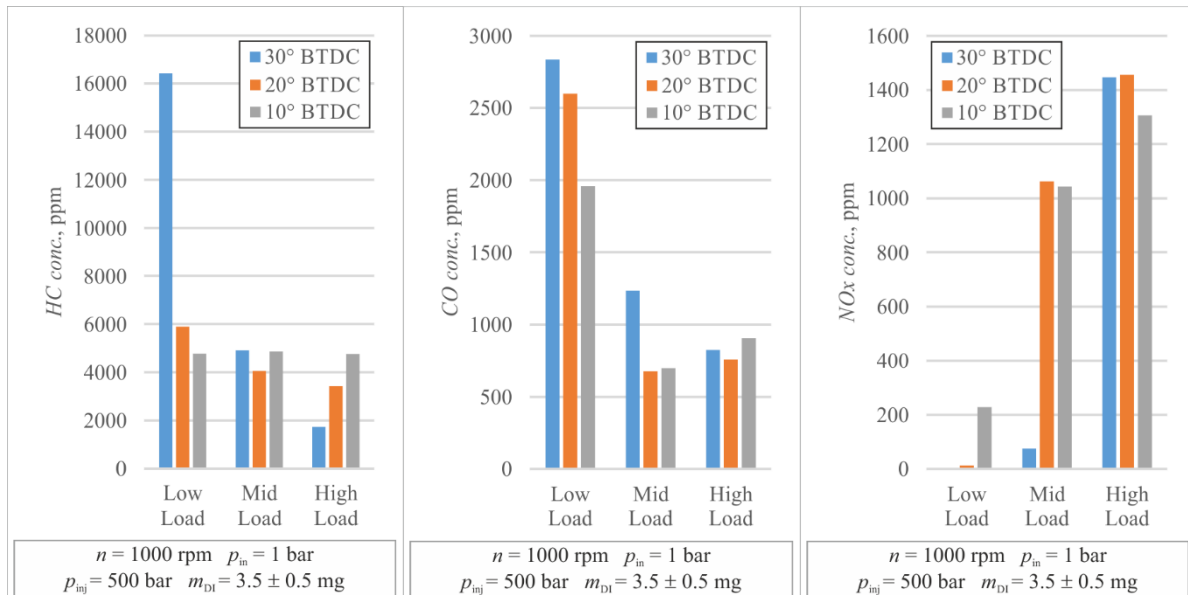

Figure 42. Effect of injection timing on HC (left), CO (middle) and NO_x (right) emissions

As aforementioned, advancing injection timing means the diesel fuel is injected into the cylinder at lower temperature. At lower temperature, combustion rate is lower. Due to longer ignition delay, better spray penetration and development occur so the larger amount of fuel-air mixture exists. As the fuel-air mixture extends, higher combustion rates occur. This leads to the increase of combustion temperatures and by that to the decrease of HC emissions. This effect can be seen on Figure 42 by studying high load.

On the other hand, at low loads, difference is that the concentration of methane is too low to compensate the reduction of reaction rate of diesel fuel. Because of that, advancing injection timing leads to local flame quenching. As an aftereffect, incomplete combustion occurs leading to a significant rise in HC emissions.

As previously described, retarding the injection timing from 20° to 10° BTDC at mid and high load causes shorter ignition delay and higher combustion rate. Because of the shorter period of spray penetration and development, locally closer to stoichiometric zones exist. Due to the local lack of oxygen in those regions, partial oxidation occurs leading to a slightly higher yield of CO. Furthermore, advancing the injection timing from 20° to 30° BTDC at mid load

also increases CO emissions slightly, as can be seen on Figure 42. As it is already known, this advance in injection timing retards the combustion phase towards expansion stroke. Therefore, cylinder temperature at the end of combustion is lower, so partial oxidation of CO to CO₂ occurs, causing an increase in CO emissions.

At low load, low in-cylinder temperatures occur. As the NO_x formation depends on temperatures higher than 1800 K, NO_x emissions are at minimum. When stable combustion occurs at mid load, in-cylinder temperatures increase causing the NO_x emissions to increase with the retardation of injection timing (from 30° to 20° BTDC). Further retardation of injection timing from 20° to 10° BTDC at mid load moves the combustion phase towards TDC causing lower combustion temperatures and by that, slightly lower NO_x emissions. At high load, due to high in-cylinder temperatures, high formation of NO_x occurs on all injection timings.

4.3 Effect of diesel fuel injection pressure

An effort has been made to keep the mass of injected diesel fuel constant at 3.3 mg. For all operating points the average mass of injected diesel fuel was 3.3 mg with a standard deviation of 0.6 mg. Three different direct injection pressures have been studied. At each injection pressure methane concentration was gradually increased to achieve low load of 2 bar, mid load of 5 bar and high load of 6 bar. Equivalence ratios are shown on Figure 43.

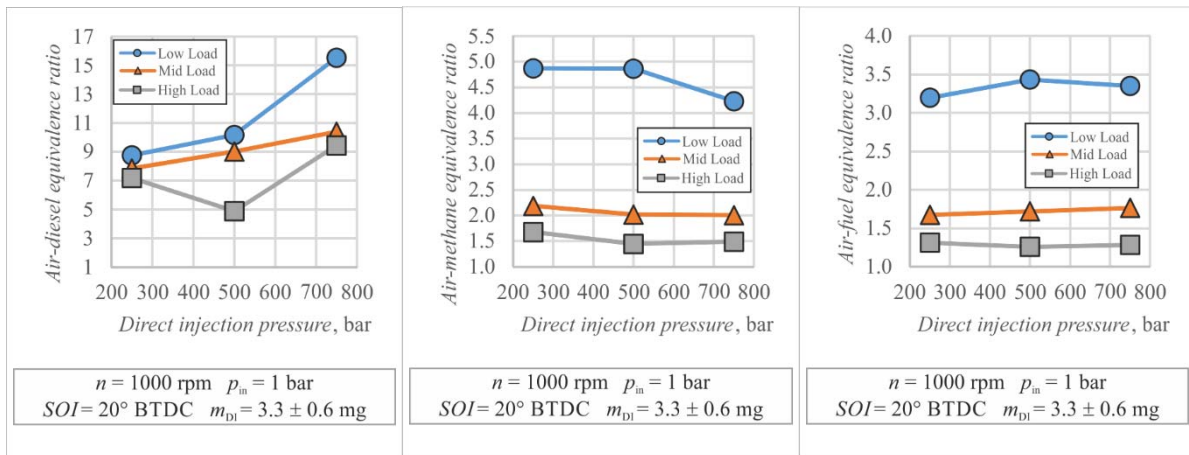

Figure 43. Change in equivalence ratios with the change of injection pressure

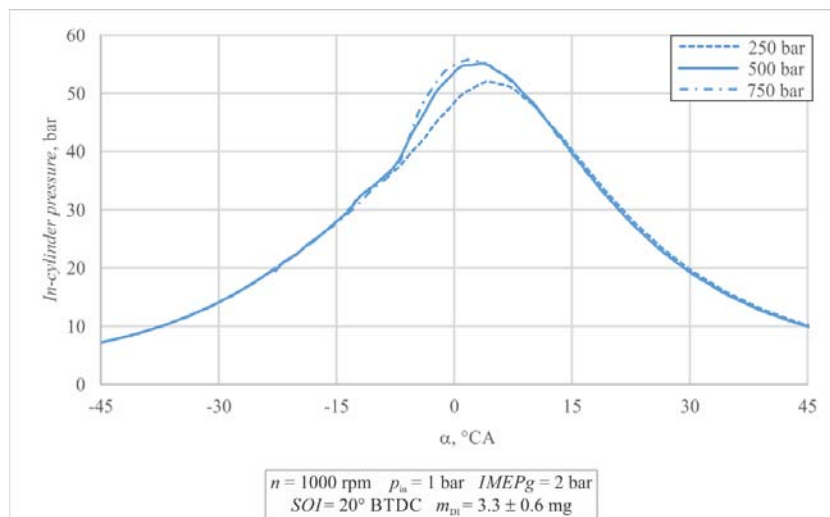

Figure 44. Effect of injection pressure on in-cylinder pressure at mid load

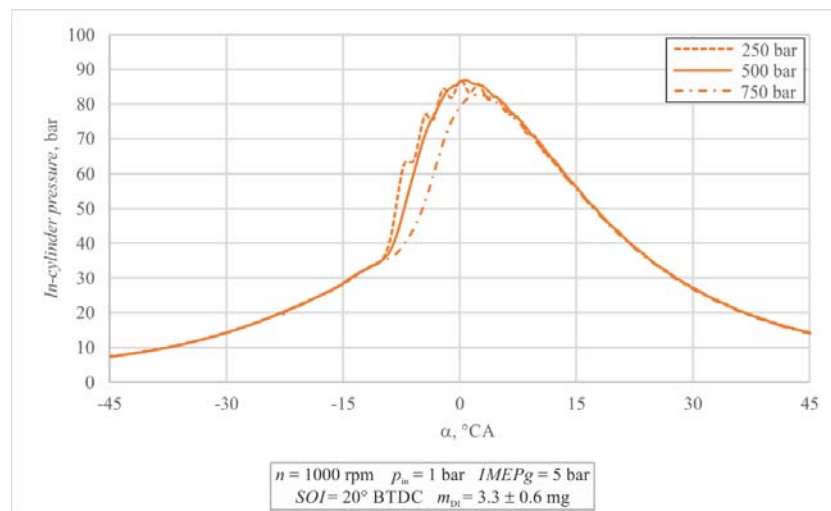

Figure 45. Effect of injection pressure on in-cylinder pressure at mid load

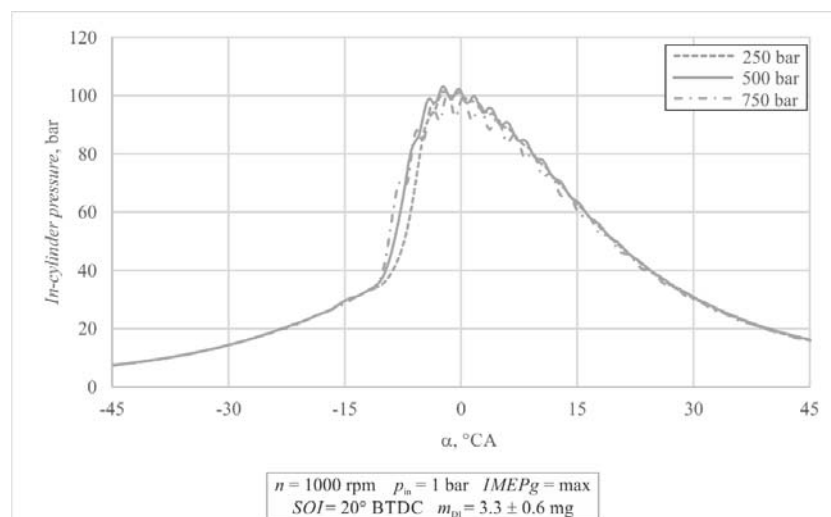

Figure 46. Effect of injection pressure on in-cylinder pressure at mid load

Lowering injection pressure causes poor atomization of diesel spray, along with lesser spray penetration and mixing. This occurs because the turbulence caused by the injection is lower. For the same diesel mass inside the cylinder, locally richer zones exist, causing higher combustion rate and pressure rise rate. This leads to in-cylinder pressure waves, seen on Figures 44, 45 and 46. However, too high injection pressure causes leaning out of the diesel fuel so the maximum cylinder pressure drops slightly. Nonetheless, despite the slight drop of maximum cylinder pressure, efficiency rises due to longer ignition delay and less work being done in the compression stroke.

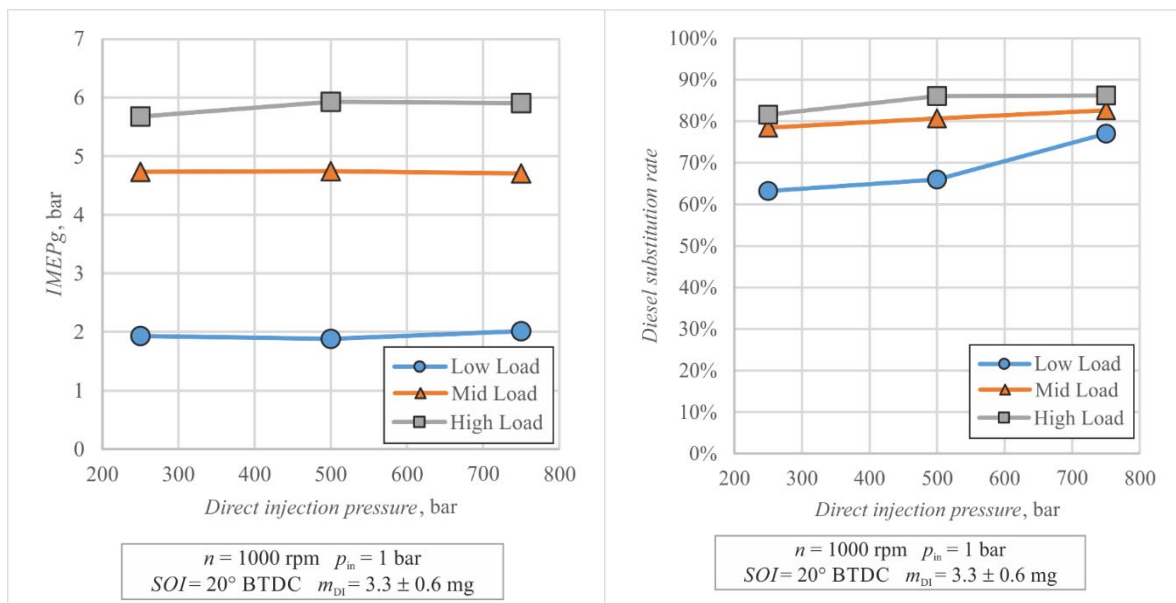

Figure 47. Effect of injection pressure on IMEPg (left) and diesel substitution rate (right)

Combustion stability, which is observed in terms of CoV on Figure 48, is very high for mid and high load. The change of injection pressure has no significant effect. CoV at low load is at optimum at the injection pressure of 500 bar, where the optimum diesel fuel atomization occurs.

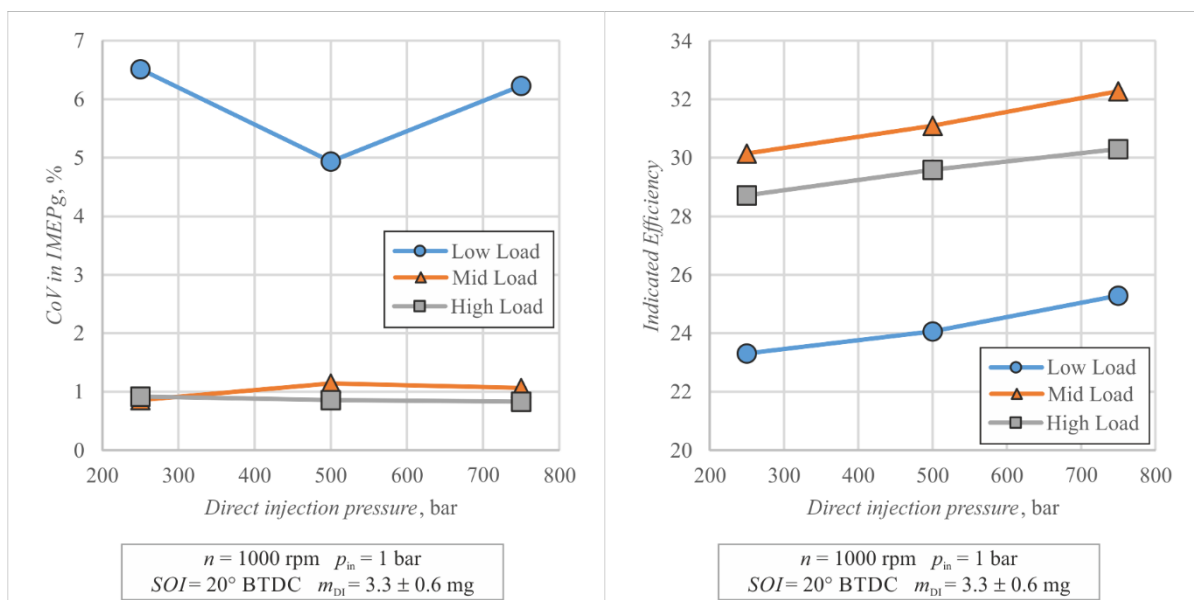

Figure 48. Effect of injection pressure on CoV in IMEPg (left) and indicated efficiency (right)

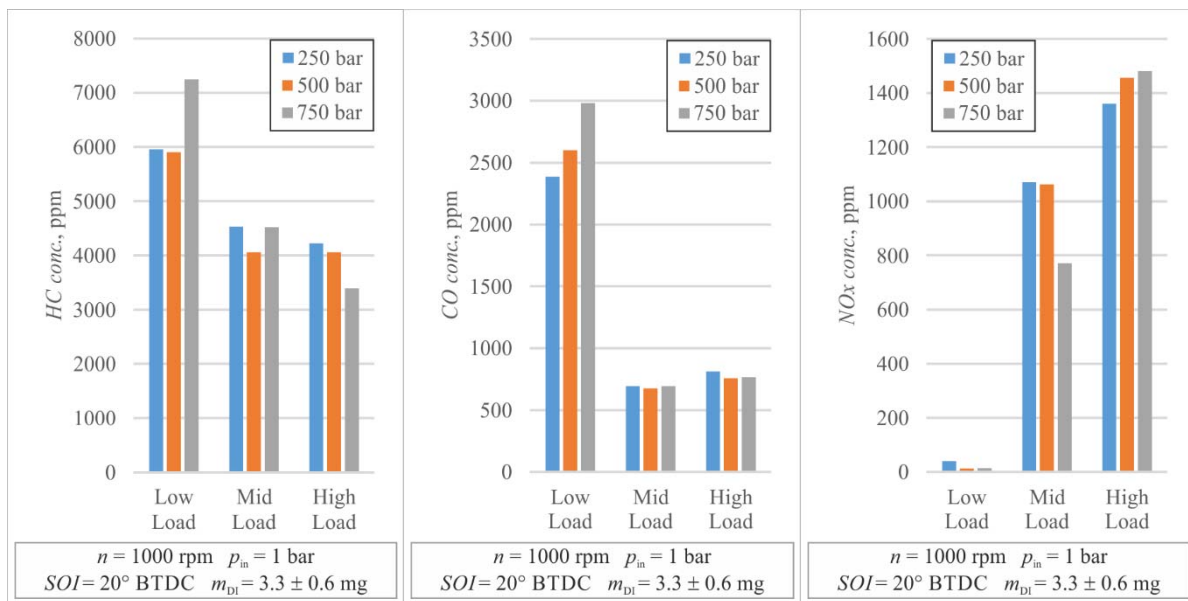

Figure 49. Effect of injection pressure on HC (left), CO (middle) and NO_x (right) emissions

As the injection pressure increases, better atomization of diesel fuel leads to higher combustion rate. Higher combustion rate implies that local quenching is reduced and by that HC emissions are brought down. However, a different effect can be seen at low and mid load when injection pressure rises above a certain point, specifically, from 500 bar to 750 bar. With better atomization of diesel fuel, locally leaner zones are formed, resulting in lower combustion rate. An additional flame speed decrease occurs due to the low concentration of methane inside the cylinder, causing local flame quenching. Ultimately, HC emissions increase. When the concentration of methane inside the cylinder rises, the effect diminishes at mid load and is completely reversed at high load due to the rise of methane fuel-air equivalence ratio.

As previously explained, decrease of injection pressure causes formation of locally closer to stoichiometric fuel zones. At mid and high load, this leads to a slight increase of CO emissions. At low load, an increase of CO emissions is caused by the increase of injection pressure. As injection pressure rises, better fuel atomization implies leaning out of diesel fuel. Therefore, lower flame speeds lead to local quenching and partial oxidation. Ultimately, an increase of CO emissions occurs.

NO_x emissions increase with the decrease of injection pressure, as can be seen for low and mid load on Figure 49. The effect is more noticeable at mid load due to significantly higher emissions than those at low load. Locally closer to stoichiometric fuel zones cause higher combustion rates and higher combustion temperature. More NO_x particles are then formed.

However, with the increase of injection pressure at high load, due to the high methane concentration, leaning out of diesel fuel establishes greater mixed region. Higher flame speed, caused by closer to stoichiometric gaseous fuel-air equivalence ratio, induces higher combustion rate and temperature. Conditions are then met for higher NO_x production.

4.4 Effect of engine speed

Two different engine speeds have been studied, low speed of 1000 rpm, upon which all previous results are based, and high speed of 1800 rpm. To study the effect of engine speed, three different sets of engine parameters were taken into account, both for the engine speed of 1000 rpm and for the engine speed of 1800 rpm. For each set of parameters, the effect of engine speed was studied separately and observed if it is in agreement with other sets.

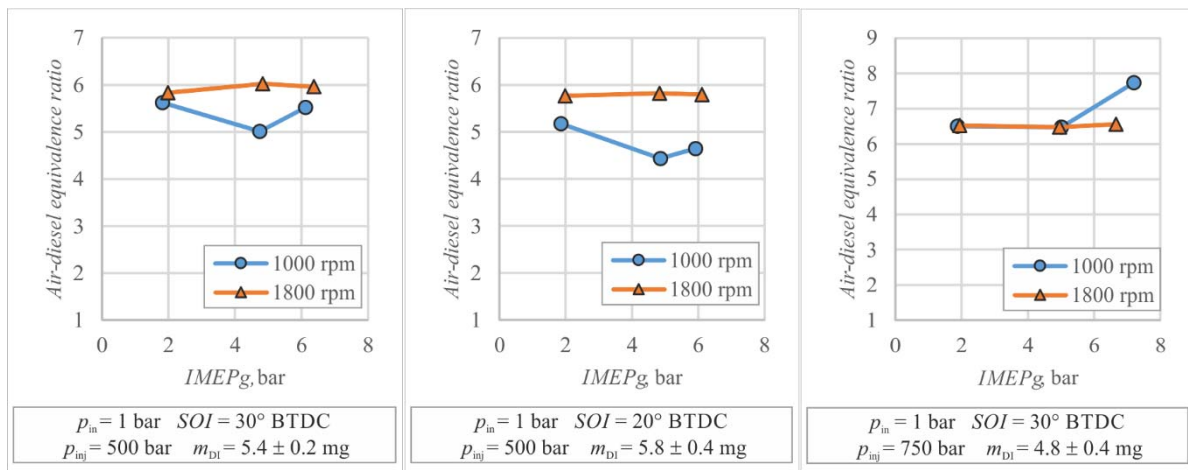

Figure 50. Air-diesel equivalence ratio for different sets of engine parameters

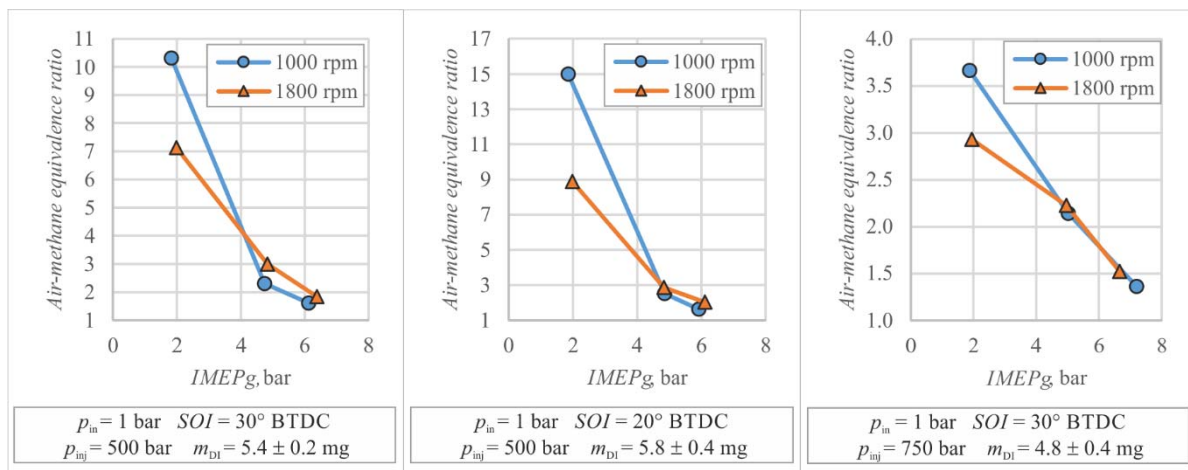

Figure 51. Air-methane equivalence ratio for different sets of engine parameters

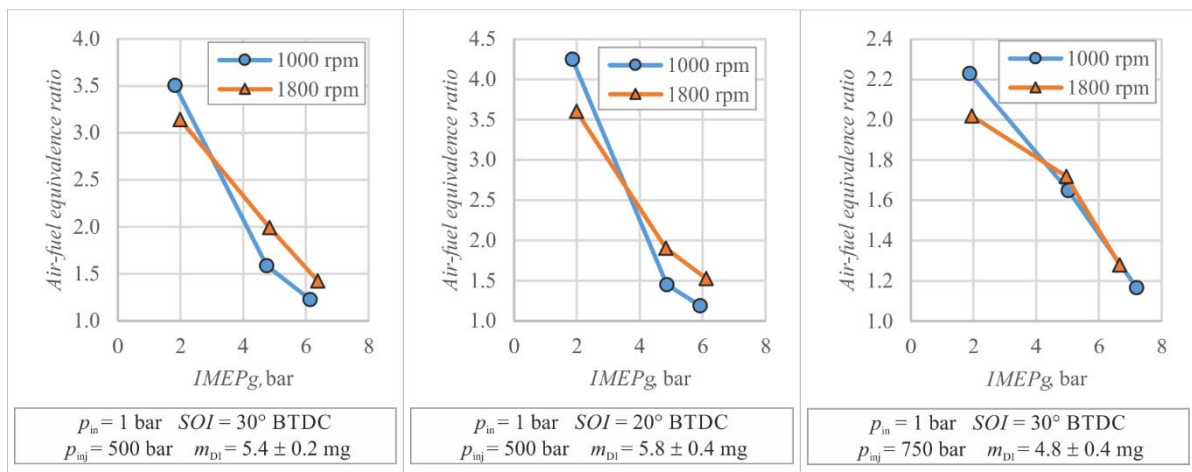

Figure 52. Air-fuel equivalence ratio for different sets of engine parameters

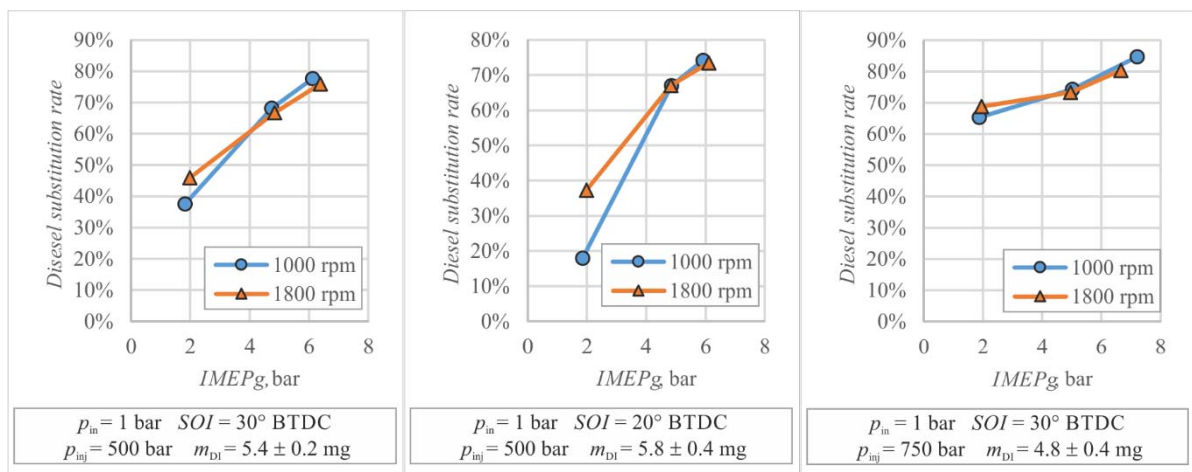

Figure 53. Diesel substitution rates for different sets of engine parameters

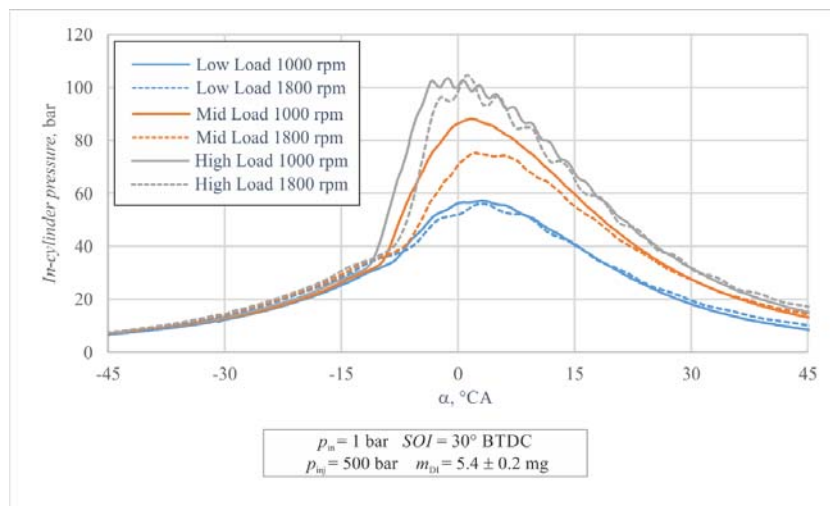

Figure 54. Effect of engine speed on in-cylinder pressure

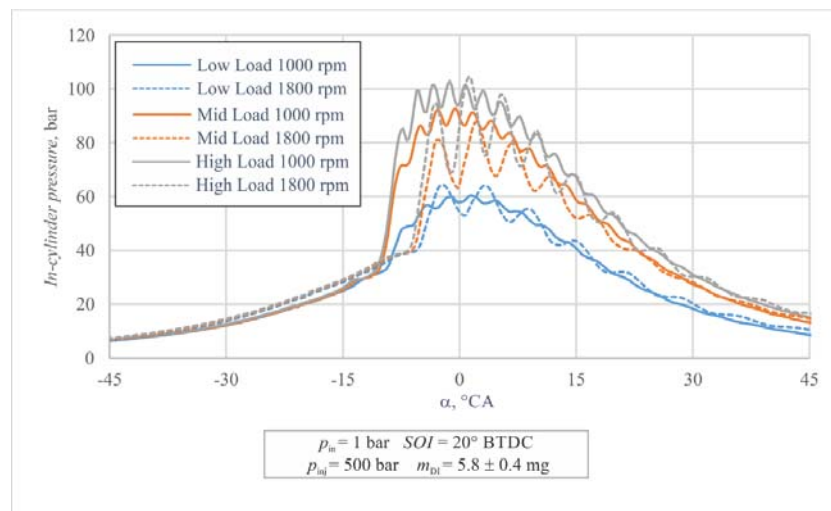

Figure 55. Effect of engine speed on in-cylinder pressure

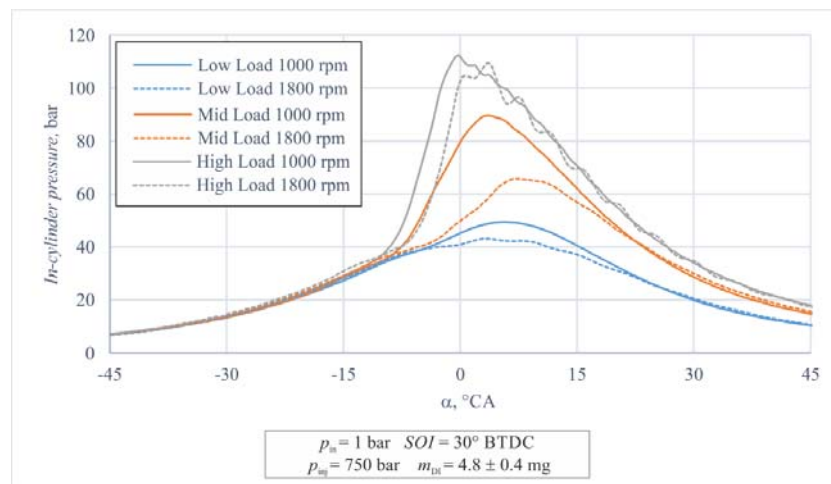

Figure 56. Effect of engine speed on in-cylinder pressure

At higher engine speed, for the same fuel-air equivalence ratio, pressure and temperature, ignition delay remains the same. However, due to the higher engine speed, same ignition delay implies the increase of the crank angle degrees needed for ignition delay. This leads to the retardation of the combustion phase, which can be seen at Figures 54, 55 and 56. At low load, premixing is too high for mixture to ignite. Ignition occurs when the mixture becomes less diluted with the increase of engine load, leading to seamless combustion at high load.

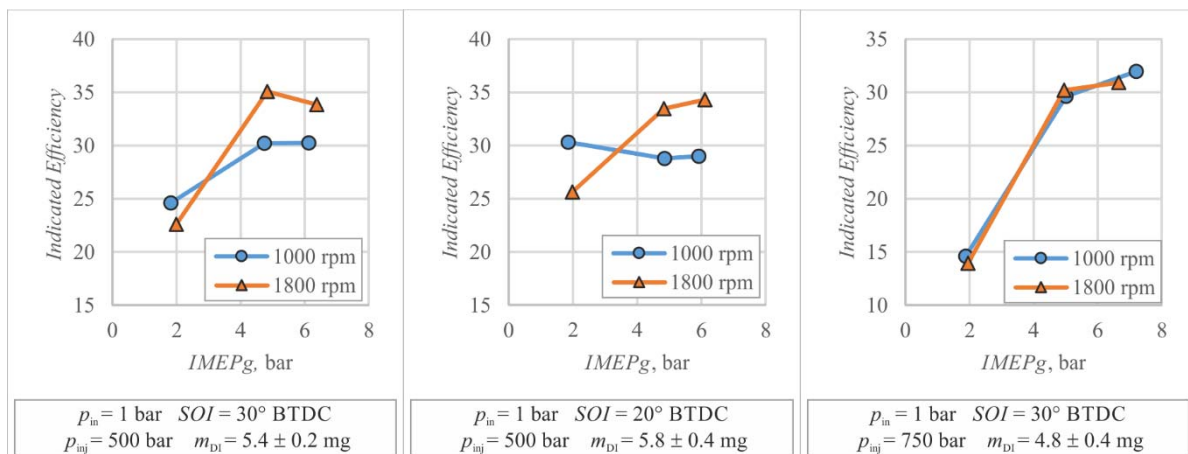

Figure 57. Effect of engine speed on indicated efficiency for different sets of engine parameters

As can be seen on Figure 57, at low engine load, indicated efficiency of operating points at the engine speed of 1800 rpm is lower compared to the engine speed of 1000 rpm. This is caused by the prolonged ignition delay which at low load causes diesel fuel to lean out and fail to ignite. Generally, at mid and high loads, as the combustion phase is retarded by increasing the engine speed, combustion process is shifted closer to the expansion stroke, causing lower heat losses and by that, the increase of the indicated efficiency.

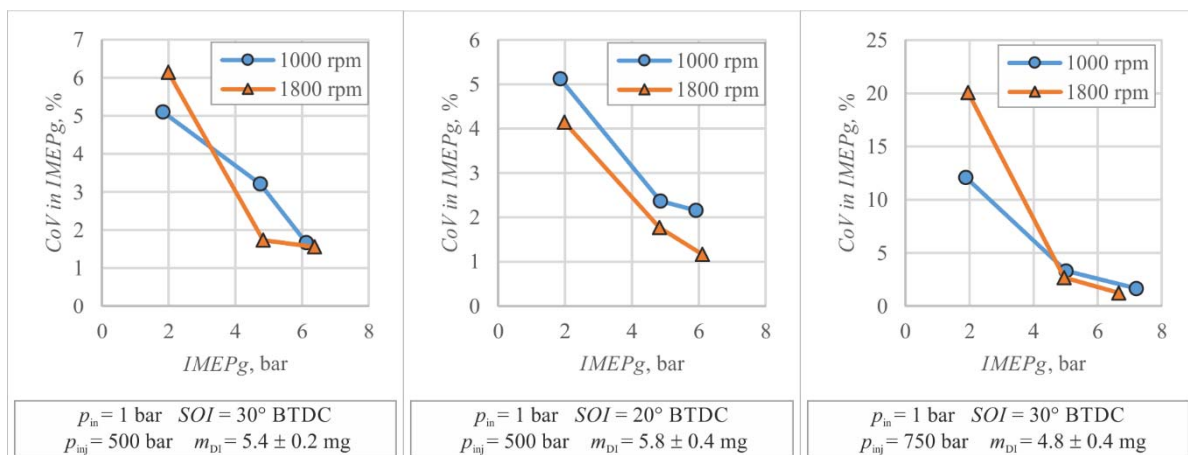

Figure 58. Effect of engine speed on CoV in IMEPg for different sets of engine parameters

CoV in IMEPg, shown on Figure 58, shows that generally combustion stability is greater at higher engine speed. Due to the longer ignition delay, premixing of air and diesel fuel inside the cylinder is better. This leads to better reaction rate and by that, greater stability in flame propagation. However, at low load, some operating points experience less stable combustion at higher engine speed. This occurs due to the combination of two phenomena. First, the highly diluted gaseous fuel at lower load causes low flame speed, and secondly, the high speed causes

leaner diesel fuel zones. If the diesel fuel leans out past a certain point, flame propagation is no longer properly achieved. Misfires then start to happen, causing an increase of combustion instability.

As is shown on Figure 59, an increase of engine speed leads to an increase of HC emissions. Due to delayed combustion at higher engine speeds, local flame quenching occurs. This means that less fuel is being burned, resulting in higher HC emissions.

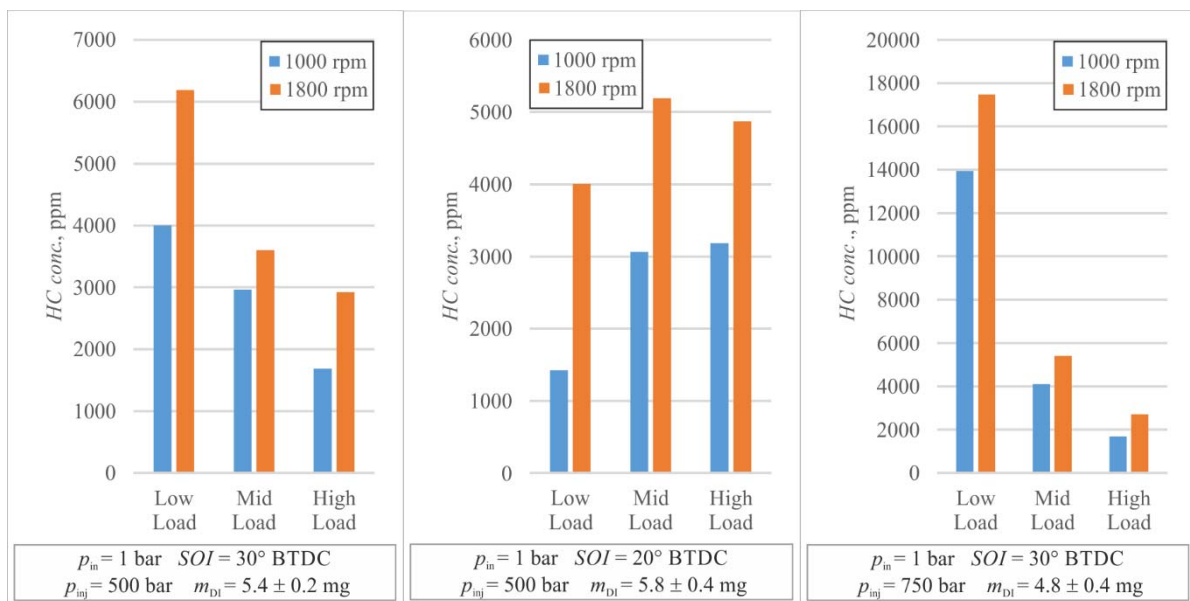

Figure 59. Effect of engine speed on HC emissions for different sets of engine parameters

Generally, at low and mid load, the increase of engine speed causes a rise in CO emissions. Lower temperatures, which occur due to the longer ignition delay, cause local flame quenching and by that, partial oxidation. Those conditions are suitable for production of CO, by not allowing complete oxidation from CO to CO₂, so CO emissions increase.

However, at high load, where the flame speeds are sufficient for very stable combustion, an increase of engine speed causes a reduction of CO emissions, due to the formation of leaner fuel zones.

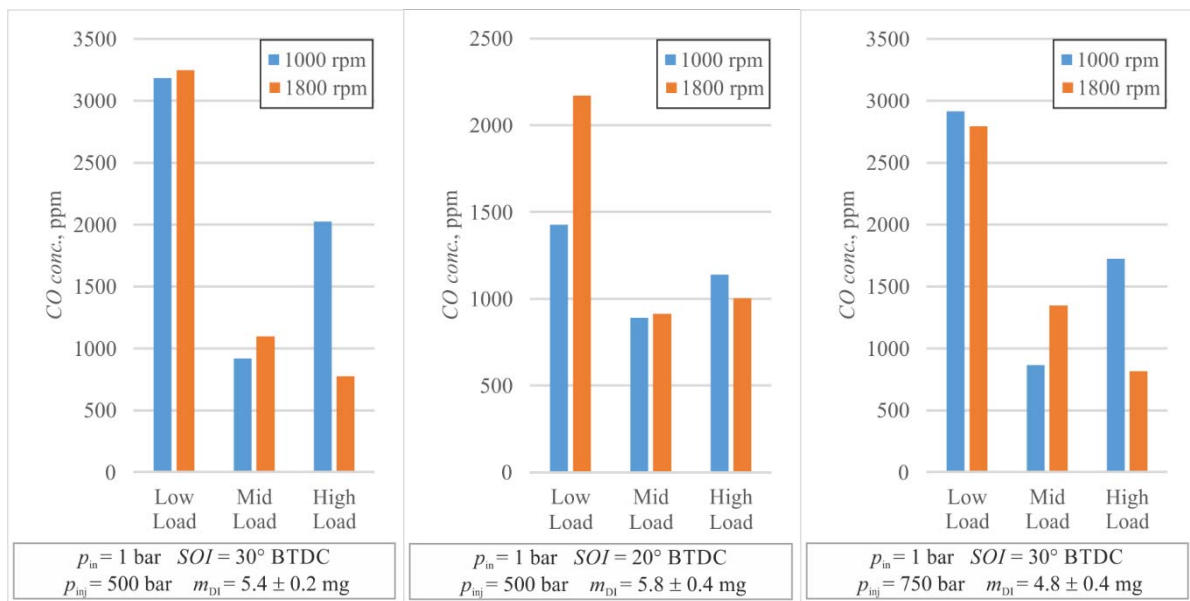

Figure 60. Effect of engine speed on CO emissions for different sets of engine parameters

Concerning NO_x emissions, Figure 61 clearly shows that the increase of engine speed causes a decrease of NO_x emissions. As was previously clarified, longer ignition delay implies leaning out of diesel fuel. This leads to lower in-cylinder pressure and temperature. As the NO_x formation process demands high temperatures, NO_x emissions decrease.

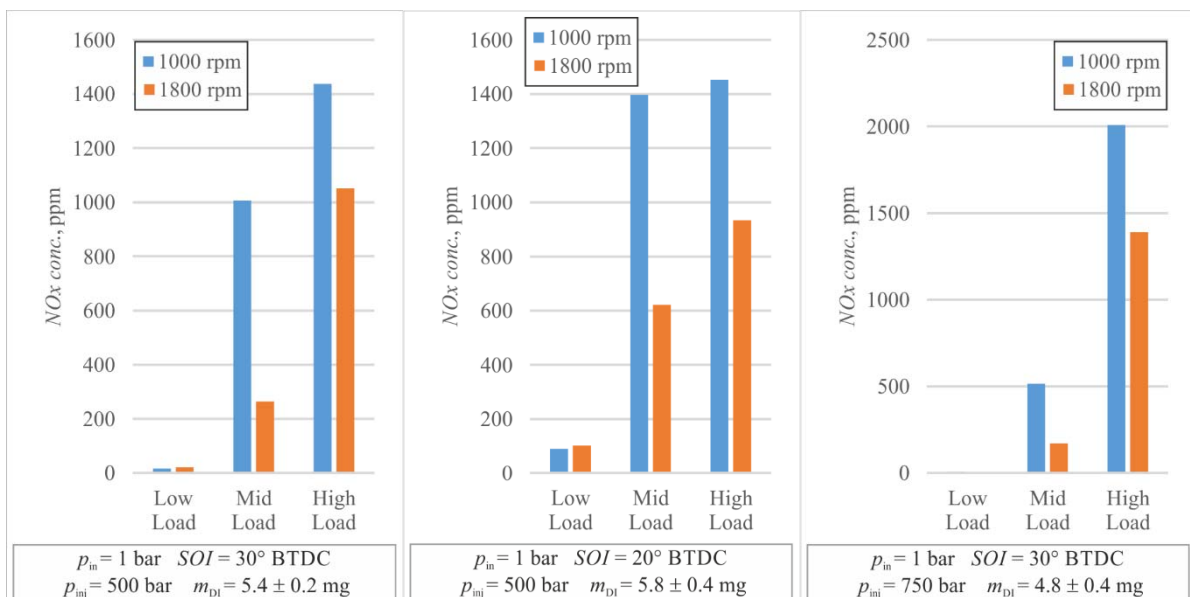

Figure 61. Effect of engine speed on NO_x emissions for different sets of engine parameters

5 GENERAL OVERVIEW AND CONCLUSIONS

The main objective of this thesis was to gain an improved understanding of the physical phenomena of dual-fuel combustion mechanisms occurring in a Diesel engine. The dual-fuel operation concept investigated here used methane as a premixed fuel to create a homogeneous mixture inside the cylinder with ignition achieved by direct injection of diesel fuel.

It has been found that under mid and high load stable operation can be achieved. Due to the high methane concentration, higher flame speeds imply stable combustion. HC and CO emissions are lowered, but under the cost of the significant rise of NO_x emissions compared to low load. Low load operation is characterized with low efficiency and high CoV in IMEP_g, implying high combustion instability. Due to local flame quenching the cylinder temperatures are low causing low NO_x emissions. However, under low load HC and CO emissions are extremely high.

A detailed analysis of the experimental results has shown that, in terms of combustion stability and emissions, engine parameters can be found so that the engine works efficiently while maintaining lower emissions. The following conclusions can be made:

- Too low amount of diesel fuel causes leaner fuel regions which have trouble igniting, but too high amount of diesel fuel causes higher pressure rise rates and by that the in-cylinder pressure waves.
- If the injection timing is more advanced than necessary, diesel fuel is injected into the cylinder at temperatures that are not sufficient for ignition. On the other hand, if the injection timing is excessively retarded, the temperatures are too high, again causing higher pressure rise rates and the in-cylinder pressure waves.
- Lower injection pressure implies poor atomization of diesel fuel, causing higher pressure rise rates, but too high injection pressure indicates leaner fuel zones and delayed ignition.

It is clear that more research is still required in order to evaluate the dual fuel operation mode. After the additional work, the widespread use of dual fuel engines in transportation may be possible, but firstly, problems such as low load operation must be addressed.

REFERENCES

- [1] Mahalec, I., Lulić, Z., Kozarac, D.: *Motori s unutaršnjim izgaranjem*; Interna skripta, FSB, 2012
- [2] Bell, S.: *Natural Gas as a Transportation Fuel*; SAE Technical Paper 931829, 1993, doi:10.4271/931829
- [3] Šagi, G., Tomić, R., Ilinčić, P.: *Razvoj propisa o dopuštenim emisijama štetnih tvari iz motora s unutaršnjim izgaranjem*; GOMABN 48, 2, 159-188
- [4] Weaver, C., Turner, S.: *Dual Fuel Natural Gas/Diesel Engines: Technology, Performance, and Emissions*; SAE Technical Paper 940548, 1994, doi:10.4271/940548
- [5] Korakianitis, T., Namasivayam, A. M., Crookes, R. J.: *Natural-gas fueled spark ignition (SI) and compression-ignition (CI) engine performance and emissions*; Progress in Energy and Combustion Science 37 (1), 2011, 89-112, doi: 10.1016/j.pecs.2010.04.002
- [6] Lounici, M.S., Loubar, K., Tarabet, L., Balistrrou, M., Niculescu, D., Tazerout, M.: *Towards improvement of natural gas-diesel dual fuel mode: An experimental investigation on performance and exhaust emissions*; Energy 64, 2014, 200-211, doi:10.1016/j.energy.2013.10.091
- [7] Wei, L., Geng, P.: *A review on natural gas/diesel dual fuel combustion, emissions and performance*; Fuel Processing Technology 142, 2016, 264-278, doi:10.116/j.fuproc.2015.09.018
- [8] Liu, S., Zhou, L., Wang, Z., Ren, J.: *Combustion characteristics of compressed natural gas/diesel dual fuel turbocharged compressed ignition engine*; Proceedings of the Institution of Mechanical Engineers, Part D: Journal of Automobile Engineering 217 (D9), 2003, 833-838, doi:10.1177/095440700321700909
- [9] Krishnan, S.R., Srinivasan, K.K., Singh, S., Willi, M.: *Strategies for Reduced NOx Emissions in Pilot-Ignited Natural Gas Engines*; Journal of Engineering for Gas Turbines and Power 126 (3), 2004, doi:10.1115/1.1760530
- [10] Nwafor, O.M.I.: *Effect of advanced injection timing on emission characteristics of diesel engine running on natural gas*; Renewable Energy 32 (14), 2007, 2361-2368, doi:10.1016/j.renene.2006.12.006

- [11] Abdelaal, M.M., Hegab, M.M.: *Combustion and emission characteristics of a natural gas-fueled diesel engine with EGR*; Energy Conversion and Management 64, 2012, 301-312, doi:10.1016/j.enconman.2012.05.021
- [12] Gatts, T., Liu, S., Liew, C., Ralston, B., Bell, C., Li, H.: *An experimental investigation of incomplete combustion of gaseous fuels of a heavy-duty diesel engine supplemented with hydrogen and natural gas*; International Journal of Hydrogen Energy 37 (9), 2012, 7848-7859, doi:10.1016/j.ijhydene.2012.01.088
- [13] Egusquiza, J.C., Braga, S.L., Braga, C.V.M.: *Performance and gaseous emissions characteristics of a natural gas/diesel dual fuel turbocharged and aftercooled engine*; Journal of the Brazilian Society of Mechanical Sciences and Engineering 31 (2), 2009, doi:10.1590/S1678-58782009000200007
- [14] Papagiannakis, R.G., Rakopoulos, C.D., Hountalas, D.T., Rakopoulos, D.C.: *Emission characteristics of high speed, dual fuel, compression ignition engine operating in a wide range of natural gas/diesel fuel proportions*; Fuel 89 (7), 2010, 1397-1406, doi:10.1016/j.fuel.209.11.011
- [15] Imran, S., Embersoon, D.R., Diez, A., Wen, D.S., Crookes, R.J., Korakianitis, T.: *Natural gas fueled compression ignition engine performance and emissions maps with diesel and RME pilot fuels*; Applied Energy 124, 2014, 354-365, doi:10.1016/j.apenergy.2014.02.067
- [16] Cheenkachom, K., Poompipatpong, C., Ho, C.G.: *Performance and emissions of a heavy-duty diesel engine fueled with diesel and LNG (liquid natural gas)*; Energy 53, 2013, 52-57, doi:10.1016/j.energy.2013.02.027
- [17] Volkswagen of America, Inc.: *Self study program: 2.0 Liter TDI Common Rail BIN5 ULEV Engine*; 2008, USA
- [18] Konigsson, F.: *Advancing the Limits of Dual Fuel Combustion*; Royal Institute of Technology, 2012, Stockholm
- [19] Papagiannakis, R.G., Hountalas, D.T., Rakopoulos, C.D.: *Theoretical study of the effects of pilot fuel quantity and its injection timing on the performance and emissions of a dual fuel diesel engine*; Energy Conversion and Management 48 (11), 2007, 2951-2961, doi:10.1016/j.enconman.2007.07.003

- [20] Sun, L., Liu, Y., Zeng, K., Yang, R., Hang, Z.: *Combustion performance and stability of a dual-fuel diesel-natural-gas engine*; Proceedings of the Institution of Mechanical Engineers, Part D: Journal of Automobile Engineering 229 (2), 2015, 235-246, doi:10.1177/0954407014537814
- [21] *NI Direct Injector Driver System User Guide*, National Instruments, 2014, USA
- [22] *Pressure sensors for combustion analysis: Product Catalog*; AVL Group, 2013, Austria
- [23] *Instruction manual: Flame ionization magneto-pneumatic analyzer FMA-220 (FIA-220/MPA-220)*; Horiba manual no 091217; Horiba instruments inc., 1989 USA
- [24] *Instruction manual: Infrared analyzer AIA-220*; Horiba manual no 091215; Horiba instruments inc., 1989, USA
- [25] *Instruction manual: Chemiluminescent analyzer CLA-220*; Horiba manual no 091216; Horiba instruments inc., 1995, USA
- [26] Ciezki, H.K., Adomeit, G.: *Shock-tube investigation of self-ignition of n-heptane-air mixtures under engine relevant conditions*; Combustion and Flame 93 (4), 1993, 421-433, doi:10.1016/0010-2180(93)90142-P
- [27] Warnatz, J.: *Resolution of gas phase and surface combustion chemistry into elementary reactions*; International Symposium on Combustion 24, 1992, 553-579, doi:10.1016/S0082-0784(06)80070-6