

Akumulacija rashladnog učinka bankom leda

Topić, Marko

Undergraduate thesis / Završni rad

2016

Degree Grantor / Ustanova koja je dodijelila akademski / stručni stupanj: **University of Zagreb, Faculty of Mechanical Engineering and Naval Architecture / Sveučilište u Zagrebu, Fakultet strojarstva i brodogradnje**

Permanent link / Trajna poveznica: <https://um.nsk.hr/um:nbn:hr:235:529948>

Rights / Prava: [In copyright](#)/[Zaštićeno autorskim pravom.](#)

Download date / Datum preuzimanja: **2024-09-22**

Repository / Repozitorij:

[Repository of Faculty of Mechanical Engineering and Naval Architecture University of Zagreb](#)



SVEUČILIŠTE U ZAGREBU
FAKULTET STROJARSTVA I BRODOGRADNJE

ZAVRŠNI RAD

Marko Topić

Zagreb, 2016.

SVEUČILIŠTE U ZAGREBU
FAKULTET STROJARSTVA I BRODOGRADNJE

ZAVRŠNI RAD

Mentor:

Doc. dr.sc. Marino Grozdek, dipl.ing.

Student:

Marko Topić

Zagreb, 2016.



SVEUČILIŠTE U ZAGREBU
FAKULTET STROJARSTVA I BRODOGRADNJE



Središnje povjerenstvo za završne i diplomske ispite
Povjerenstvo za završne ispite studija strojarstva za smjerove:
procesno-energetski, konstrukcijski, brodstrojarski i inženjersko modeliranje i računalne simulacije

Sveučilište u Zagrebu Fakultet strojarstva i brodogradnje	
Datum	Prilog
Klasa:	
Ur.broj:	

ZAVRŠNI ZADATAK

Student: **Marko Topić**

Mat. br.: **0035181969**

Naslov rada na hrvatskom jeziku: **Akumulacija rashladnog učinka bankom leda**

Naslov rada na engleskom jeziku: **Storage of cooling energy through ice bank**

Opis zadatka:

Na primjeru banki leda koje je tvrtka Frigoterm d.o.o. iz Sesvetskog Kraljevca ugradila u sklopu termotehničkih instalacija mljekara u Norveškoj i Njemačkoj te podataka prikupljenih s mjernih uređaja kojima su banke leda opremljene potrebno je istražiti utjecaj radnih parametara na radne karakteristike banke leda.

Potrebno je:

- Napraviti shematski prikaz promatrane banke leda i instalacije kojima se spaja s rashladnim postrojenjem s prikazom točaka gdje se vrše mjerenja.
- Napraviti nacrt silosa leda.
- Prikupiti i obraditi mjerene podatke.
- Istražiti utjecaj radnih parametara (protočna količina vode u optoku unutar silosa, maksimalna debljina leda, protočna masa glikola, temperatura glikola na ulazu u banku leda, temperatura tople vode od potrošača, protočna masa tople vode od potrošača) na sposobnost akumulacije i topljenja leda.

U radu je potrebno navesti korištenu literaturu i eventualno dobivenu pomoć.

Zadatak zadan:
25. studenog 2015.

Rok predaje rada:
1. rok: 25. veljače 2016
2. rok (izvanredni): 20. lipnja 2016.
3. rok: 17. rujna 2016.

Predviđeni datumi obrane:
1. rok: 29.2., 02. i 03.03. 2016.
2. rok (izvanredni): 30. 06. 2016.
3. rok: 19., 20. i 21. 09. 2016.

Zadatak zadao:

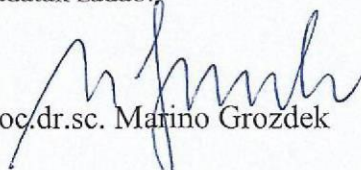
Doc.dr.sc. Matino Grozdek

Predsjednik Povjerenstva:

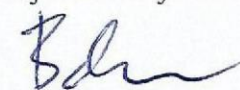
Prof. dr. sc. Igor Balen

Izjavljujem da sam ovaj rad izradio samostalno koristeći stečena znanja tijekom studija i navedenu literaturu.

Zahvaljujem se svome mentoru doc. dr. sc. Marinu Grozdeku na velikoj susretljivosti i pomoći prilikom izrade ovoga rada. Također bih zahvalio gospodinu Zlatku Vojvodi, direktoru tvrtke Frigoterm d.o.o. na pruženim materijalima na kojima se temelji moj rad.

Marko Topić

SADRŽAJ	
SADRŽAJ	5
POPIS SLIKA	7
POPIS TABLICA.....	9
POPIS TEHNIČKE DOKUMENTACIJE	10
POPIS OZNAKA	11
SAŽETAK.....	13
UVOD	14
1. PRINCIP RADA SILOSA	15
1.1. Radna tvar u cijevima silosa.....	18
1.2. Shema silosa leda	19
2. NAČINI MJERENJA AKUMULIRANE ENERGIJE	20
3. AKUMULACIJA LEDA (27.9.2013).....	21
3.1. Ovisnost akumulacije leda o protoku propilen glikola kroz cijevi.....	21
3.2. Ovisnost akumulacije leda o ulaznoj temperaturi propilen glikola u silos.....	22
3.3. Ovisnost akumulacije leda o protoku tople vode od potrošača	23
3.4. Ovisnost akumulacije leda o ulaznoj i izlaznoj temperaturi vode u silosu.....	24
3.5. Ovisnost akumulacije leda o kA produktu (koeficijent prolaza topline i površina prijenosa topline).....	25
3.5.1. Proračun kA produkta	26
3.6. Ovisnost akumulacije o ukupnom predanom toplinskom toku.....	27
4. TOPLJENJE LEDA (25.9.2013).....	28
4.1. Ovisnost topljenja leda o protoku propilen glikola kroz cijevi	29
4.2 Ovisnost topljenja leda o protoku tople vode od potrošača	30
4.3 Ovisnost topljenja leda o ulaznoj i izlaznoj temperaturi vode u silosu	31
4.4. Ovisnost topljenja leda o ukupnom predanom toplinskom toku.....	32
4.5. Toplinsko opterećenje silosa prilikom topljenja leda.....	33
4.6. Izlazna temperatura vode iz silosa	34
4.7. Ovisnost topljenja leda o αA produktu	35

5. AKUMULACIJA/TOPLJENJE LEDA (17.9.2013.).....	36
5.1. Ovisnost akumulacije leda o protoku propilen glikola kroz cijevi.....	36
5.2. Ovisnost akumulacije leda o ulaznoj temperaturi propilen glikola u silos.....	36
5.3. Ovisnost akumulacije leda o protoku tople vode od potrošača.....	37
5.4. Ovisnost akumulacije leda o ulaznoj i izlaznoj temperaturi vode u silosu	37
5.5. Ovisnost akumulacije o ukupnom predanom toplinskom toku.....	38
5.6. Ovisnost akumulacije leda o kA produktu	38
5.7. Toplinsko opterećenje silosa prilikom topljenja leda.....	39
5.8. Ovisnost topljenja leda o αA produktu	40
5.9. Izlazna temperatura vode iz silosa	40
6. ZAKLJUČAK	41
LITERATURA.....	42
TABLICE.....	43
PRILOG (nacrt silosa).....	52

POPIS SLIKA

- Slika 1. Prikaz silosa leda (Frigoterm d.o.o)
- Slika 2. Prikaz modularne konstrukcije silosa (Frigoterm d.o.o)
- Slika 3. Presjek akumulacijskog modula (Frigoterm d.o.o)
- Slika 4. Shema silosa leda i instalacije (Frigoterm d.o.o)
- Slika 5. Akumulirani led na cijevima u ovisnosti o protoku propilen glikola kroz cijevi
- Slika 6. Akumulirani led u ovisnosti o ulaznoj temperaturi propilen glikola u silos
- Slika 7. Akumulirani led u ovisnosti o protoku tople vode prema silosu
- Slika 8. Akumulirani led u ovisnosti o temperaturi vode na ulazu u silos
- Slika 9. Produkt koeficijenta prolaza topline i površine leda u ovisnosti o akumulaciji leda u silosu
- Slika 10. Kontrolni volumen prikazan kao segment promatrane cijevi (Marino Grozdek, 2009)
- Slika 11. Ovisnost akumulacije o ukupnom dovedenom toplinskom toku
- Slika 12. Topljenje leda u ovisnosti o protoku propilen glikola
- Slika 13. Topljenje leda u ovisnosti o protoku tople vode od potrošača
- Slika 14. Topljenje leda u ovisnosti o temperaturi vode na ulazu i izlazu iz silosa
- Slika 15. Topljenje leda u ovisnosti o ukupnom dovedenom toplinskom toku
- Slika 16. Toplinsko opterećenje u procesu topljenja leda
- Slika 17. Temperatura izlazne vode iz silosa kroz vrijeme
- Slika 18. αA produkt u ovisnosti o topljenju leda u vremenu
- Slika 19. Ovisnost akumulacije leda o protoku propilen glikola kroz cijevi
- Slika 20. Ovisnost akumulacije leda o ulaznoj temperaturi propilen glikola u silos

- Slika 21. Ovisnost akumulacije leda o protoku tople vode od potrošača
- Slika 22. Ovisnost akumulacije leda o ulaznoj i izlaznoj temperaturi vode u silosu
- Slika 23. Ovisnost akumulacije o ukupnom dovedenom toplinskom toku
- Slika 24. Ovisnost akumulacije leda o kA produktu
- Slika 25. Toplinsko opterećenje u procesu topljenja leda
- Slika 26. αA produkt u ovisnosti o topljenju leda u vremenu
- Slika 27. Temperatura izlazne vode iz silosa

POPIS TABLICA

Tablica 1. PODACI za proces akumulacije leda 27.9.2013.

Tablica 2. PODACI za proces topljenja leda 25.9.2013

Tablica 3. PODACI za proces akumulacije/topljenja leda 17.9.2013.

POPIS TEHNIČKE DOKUMENTACIJE

1. Schematic diagram – SILO IWA3760 (Frigoterm d.o.o)

POPIS OZNAKA

Oznaka	Jedinica	Opis
$\Delta\dot{m}_i^{cv}$	[kg]	-promjena mase leda kontrolnog volumena
Δt	[s]	-promjena vremena
$\dot{m}_{w,in}^{cv}$	[kg/s]	-ulazni maseni protok vode kontrolnog volumena
$\dot{m}_{w,out}^{cv}$	[kg/s]	-izlazni maseni protok vode kontrolnog volumena
\dot{m}_w^{cv}	[kg/s]	-maseni protok vode kontrolnog volumena
\dot{m}_b^{cv}	[kg/s]	-maseni protok propilen glikola kontrolnog volumena
c_{pw}	[kJ/kgK]	-specifični toplinski kapacitet vode
c_{pb}	[kJ/kgK]	-specifični toplinski kapacitet propilen glikola
$\Delta\vartheta_w$	[°C]	-promjena temperature vode
$\Delta\vartheta_b$	[°C]	-promjena temperature propilen glikola
$\vartheta_{w,m}$	[°C]	-srednja temperatura vode
$\vartheta_{b,m}$	[°C]	-srednja temperatura propilen glikola
$\vartheta_{w,silo\ down}$	[°C]	-temperatura vode na dnu silosa (mješavina tople ulazne vode i ohlađene vode u cirkulaciji kroz silos)
A_i^{cv}	[m ²]	-površina cijevi kontrolnog volumena
α_i	[W/m ² K]	-koeficijent prijelaza topline sa strane vode na led
k_i	[W/m ² K]	-koeficijent prolaza topline (sveden na vanjsku površinu leda)
ΔL^{cv}	[m]	-duljina kontrolnog volumena cijevi
r_i	[mm]	-polumjer leda na cijevima
r_1	[m]	-unutrašnji polumjer cijevi
r_2	[m]	-vanjski polumjer cijevi

λ_t	[W/mK]	-toplinska vodljivost cijevi
λ_i	[W/mK]	-toplinska vodljivost leda
Φ_{in}	[kW]	-toplinsko opterećenje silosa od potrošača
$\Phi_{w,\theta}$	[kW]	-osjetna toplina promjene temperature glavnine vode
$\Phi_{w,M}$	[kW]	-osjetna toplina kod promjene mase vode u silosu
$\Phi_{w,ice}$	[kW]	-toplina prenesena s vode na led
Φ_{uk}	[kW]	-ukupna dovedena toplina silosu
Φ_w	[kW]	-dovedena toplina vodom od potrošača
Φ_b	[kW]	-odvedena toplina propilen glikolom

SAŽETAK

U ovom završnom radu cilj je bio proučiti utjecaj radnih parametara na radne karakteristike banke leda, tj. sposobnost akumulacije i topljenja leda.

Moj zadatak je bio proučavanje akumulacije rashladnog učinka bankom leda na primjeru banke leda, izrađene od tvrtke Frigoterm d.o.o. iz Sesevskog Kraljevca u sklopu instalacije mljekare u Norveškoj.

Razlozi upotrebe banki leda su zbog uštede energije, a princip je prebacivanje vršnog opterećenja u noćne sate u kojima je električna energija jeftinija. Time se ujedno može koristiti i sustav manje snage budući da se koristi akumulacija leda tijekom vremena, što donosi dodatne uštede.

Način na koji se pristupilo radu je bio obradom mjerenih podataka iz silosa, čime se proučavao utjecaj pojedinog parametra na sposobnost akumulacije/topljenja leda i njihov krajnji utjecaj na kA i αA produkte.

Ti produkti će nam pokazati pravu sliku akumulacijskih karakteristika promatranog sustava.

UVOD

Promatrani sustav u ovome radu spada u sustave s topljenjem leda izvana prema unutra (eng. *external melt ice on coil system*).

Ova vrsta sustava akumulacije leda akumulira led na površini cijevi koje su potopljene u silosu vode. Kroz cijevi struji sekundarni fluid, gligol ili drugo rashladno sredstvo kojemu voda iz silosa predaje toplinu čime stvara led na površini cijevi.

Led se stvara u periodu akumulacije, a topi u periodu korištenja rashladne energije u dodiru s toplom vodom iz procesa. Voda ohlađena ledom se koristi kako bi preuzela toplinsko opterećenje postrojenja.

Led se najčešće stvara do debljine od 40-65 mm na cijevima ovisno o primjeni.

Veća debljina leda je poželjna kada želimo postići nižu temperaturu vode koja se njime hladi, a manja debljina leda kada su poželjne veće temperature vode i viša iskoristivost procesa.

U procesu se želi izbjeći prevelika debljina leda (koja je unaprijed zadana proračunom), kako bi se ostavio slobodan prolaz za cirkulaciju vode između cijevi.

1. PRINCIP RADA SILOSA

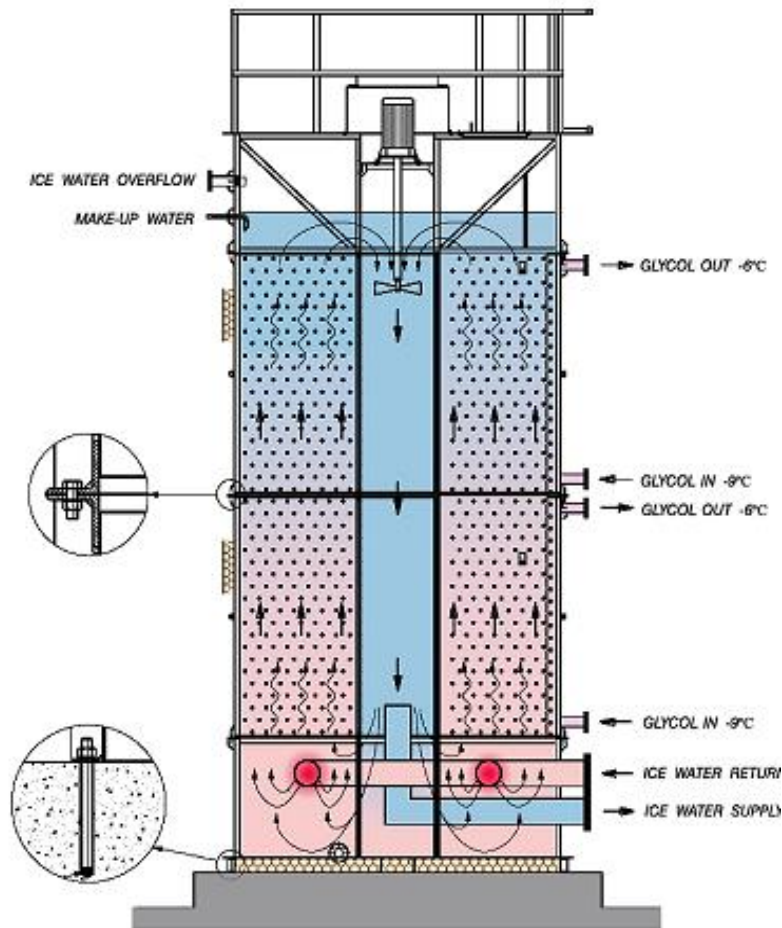

Slika 1. Prikaz silosa leda (Frigoterm d.o.o)

Ledena voda se dovodi u torusni prsten preko kojeg se ravnomjerno distribuira po presjeku baznog modula. U baznom modulu, topla povratna voda (+6°C) se miješa sa ohlađenom ledenom vodom (+0.2°C), koja cirkulira silosom i struji prema prvim cijevima. Kako je količina ohlađene ledene vode 1500 m³/h, a dolazne tople vode 250 m³/h, temperatura vode koja dolazi na prve cijevi s ledom u prvom akumulacijskom modulu je niža od 1.9 °C.

Na vrhu silosa je postavljen agitator koji povlači vodu u centralni kanal i šalje ju prema dnu silosa, gdje ohlađena voda odlazi prema postrojenju.

Broj okretaja agitatora se regulira frekventnim regulatorom koji je povezan s temperaturnom sondom koja mjeri temperaturu izmiješane vode. Ukoliko je ta temperatura previsoka, tj. viša od 1,9 °C povećava se broj okretaja.

Prvi modul ima na dnu postavljenu distribucijsku ploču kojom se ledena voda usmjerava točno između cijevi.

Maksimalna količina leda na cijevima je 63 113 kg

Maksimalna akumulirana energija silosa je 5800 kWh

Silos je sastavljen od:

- baznog modula
- 6 akumulacijskih modula
- završnog modula

MODULARNA KONSTRUKCIJA

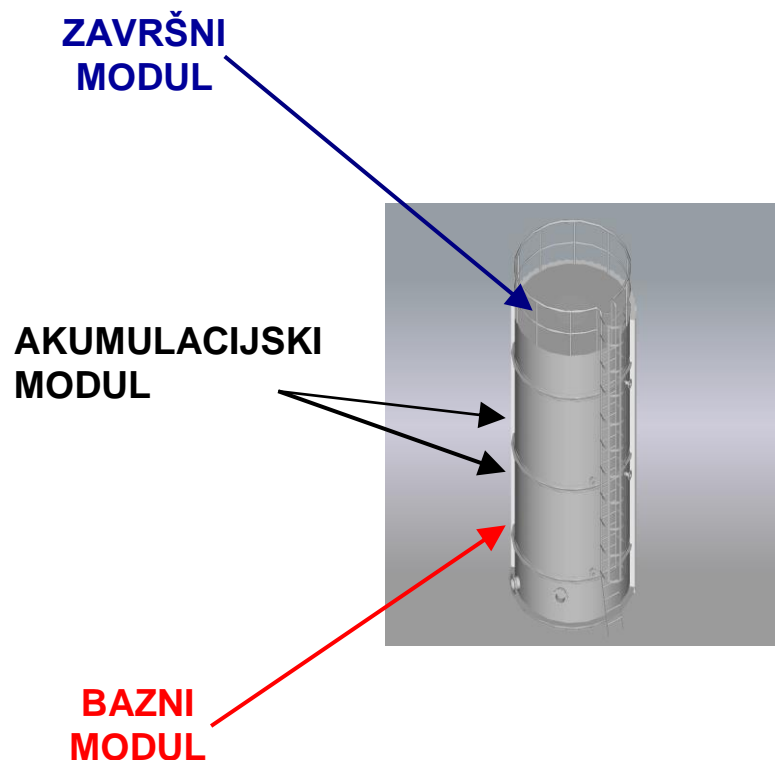

Slika 2. Prikaz modularne konstrukcije silosa (Frigoterm d.o.o)

Kroz cijevi cirkulira propilen glikol ohlađen na -7°C . Propilen glikol se prolaskom kroz cijevi grije na -4°C preuzimajući toplinu od vode, čime se na cijevima stvara led.

Cirkulacija propilen glikola kroz svaki modul se kontrolira ON/OFF funkcijom preko elektromagnetskog ventila.

Izuzetno je bitno da se prostor između cijevi ne zatvori u potpunosti s ledom, tj da se ostavi 13 mm slobodnog prostora kroz koji će voda strujati prema gore i hladiti se prenošenjem toplinske energije ledu. Isto tako je bitno da cijevi nijednog modula ne ostanu bez leda, jer se time izmjena topline smanjuje i silos gubi na kapacitetu.

Maksimalna i minimalna debljina stvorenog leda kontrolira se sensorima maksimalne i minimalne debljine leda. Ti senzori reguliraju otvaranje i zatvaranje elektromagnetskih ventila tj. protok propilen glikola. Svaki modul opremljen je sa 6 mjernih sonde koje prepoznaju minimalnu i maksimalnu debljinu leda.

Svaka mjerna sonda mjeri debljinu leda na 4 cijevi, te svaka sonda ima po dva senzora (senzor maksimalne i senzor minimalne debljine leda).

Mjerne sonde su raspoređene da se mjeri debljina leda na svakih cca. 9-10 metara cijevi.

Tako na jednom modulu imamo:

$$6 \text{ sonde} \times 4 \text{ cijevi} \times 2 \text{ senzora} = 48 \text{ senzora}$$

- 24 senzora maksimalne debljine leda po modulu i 24 senzora minimalne debljine leda po modulu.

Ti senzori mjere debljinu leda na temelju razlike u električnoj provodljivosti vode i leda.

Maksimalna debljina leda na cijevima je zadana tvornički i za ovaj silos iznosi 25 mm. Minimalna debljina leda je različita za svaki modul.

1.1. Radna tvar u cijevima silosa

Rashladno sredstvo koje cirkulira cijevima silosa je mješavina propilen glikola i vode (30% propilen glikola)

Materijal cijevi u silosu je PEHD 80, a promjer cijevi je $\Phi 32 \times 1.9$ mm.



Slika 3. Presjek akumulacijskog modula (Frigoterm d.o.o)

1.2. Shema silosa leda

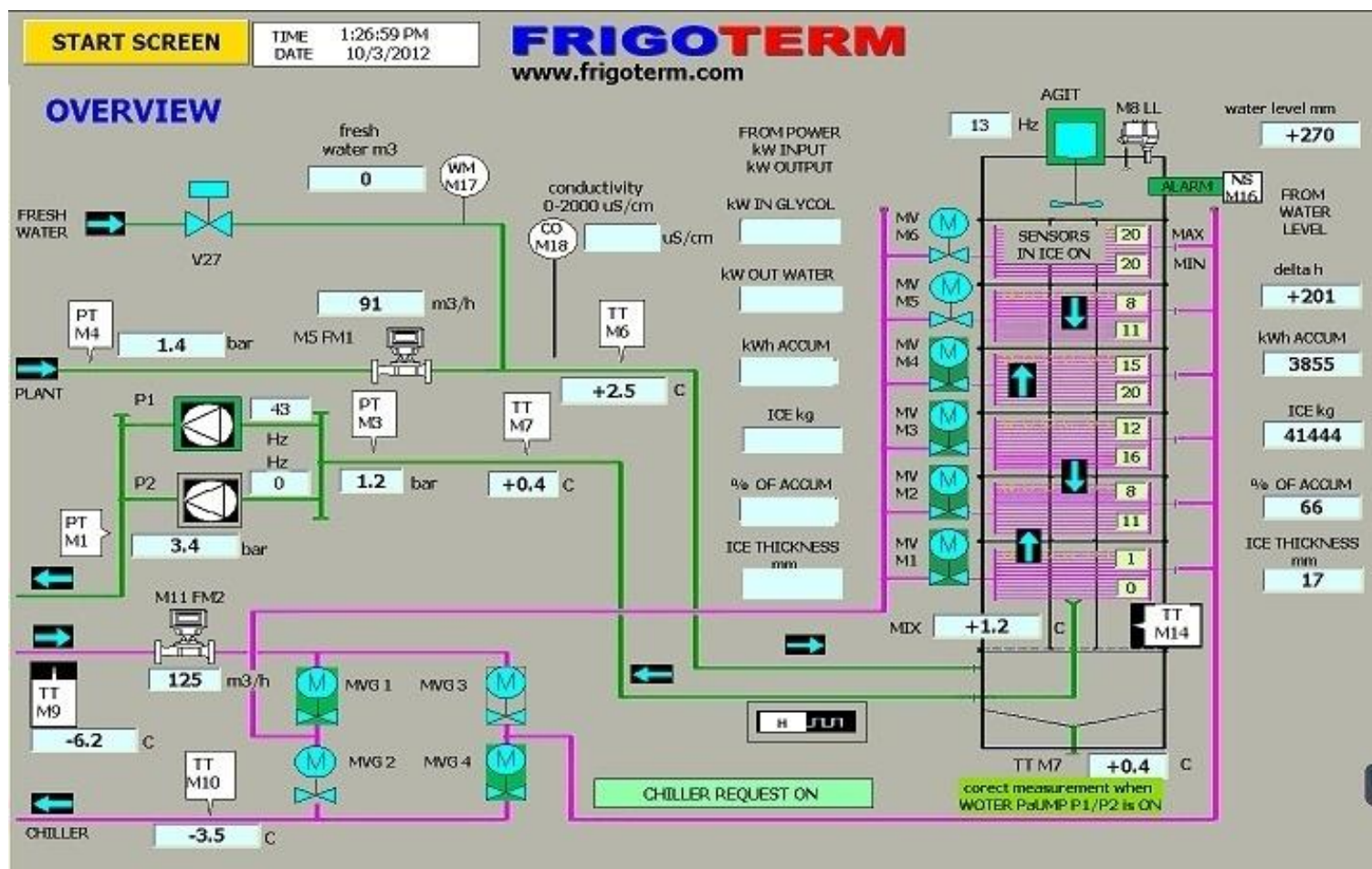

Slika 4. Shema silosa leda i instalacije (Frigoterm d.o.o)

2. NAČINI MJERENJA AKUMULIRANE ENERGIJE

- a) Mjerenjem visine vode u silosu
- b) Mjerenjem rashladne energije koja ulazi u silos cirkulacijom propilen glikola i rashladne energije koja izlazi iz silosa cirkulacijom ledene vode

a) Mjerenjem visine razine vode u silosu

Stvaranjem leda na cijevima, razina leda se povećava zbog razlike u gustoći između leda (916 kg/m^3) i vode (999 kg/m^3).

Stvaranjem leda razina vode raste, a topljenjem leda razina vode pada.

Mjerenje razine vode u silosu se vrši ultrazvučnim mjeračem razine vode, koji je postavljen na vrhu silosa. Iz mjerenih vrijednosti potom se izračunavaju vrijednosti: akumulirane energije u silosu, mase leda, postotka leda u silosu i debljine leda na cijevima.

Te vrijednosti su prikazane na desnoj strani silosa na slici 4.

b) Mjerenjem ulazne i izlazne rashladne energije silosa

Iz izmjerenog protoka propilen glikola te temperaturne razlike ulaza i izlaza propilen glikola u silos, računamo ukupnu toplinsku energiju odvedenu od vode iz silosa, tj. rashladnu energiju dovedenu silosu.

$$\Phi_b = c_{pb} \dot{m}_b \Delta \vartheta_b \quad (1)$$

Isto tako iz izmjerenog protoka vode te temperaturne razlike ulaza i izlaza vode u silos, izračunavamo ukupno toplinsko opterećenje od potrošača, tj. rashladnu energiju odvedenu od silosa.

$$\Phi_w = c_{pw} \dot{m}_w \Delta \vartheta_w \quad (2)$$

Integriranjem tih snaga u vremenu te oduzimanjem odvedene od dovedene snage dobivamo akumuliranu rashladnu energiju u silosu.

Vrijednosti dobivene ovim postupkom prikazane su na lijevoj strani silosa na slici 4.

Rezultati dobiveni iz ova dva postupka se međusobno uspoređuju i ukoliko je razlika veća od 10 % alarmom se upozorava na greške u mjerenju koje treba ispraviti kalibriranjem.

3. AKUMULACIJA LEDA- (27.9.2013.)

3.1. Ovisnost akumulacije leda o protoku propilen glikola kroz cijevi (27.9.2013.)

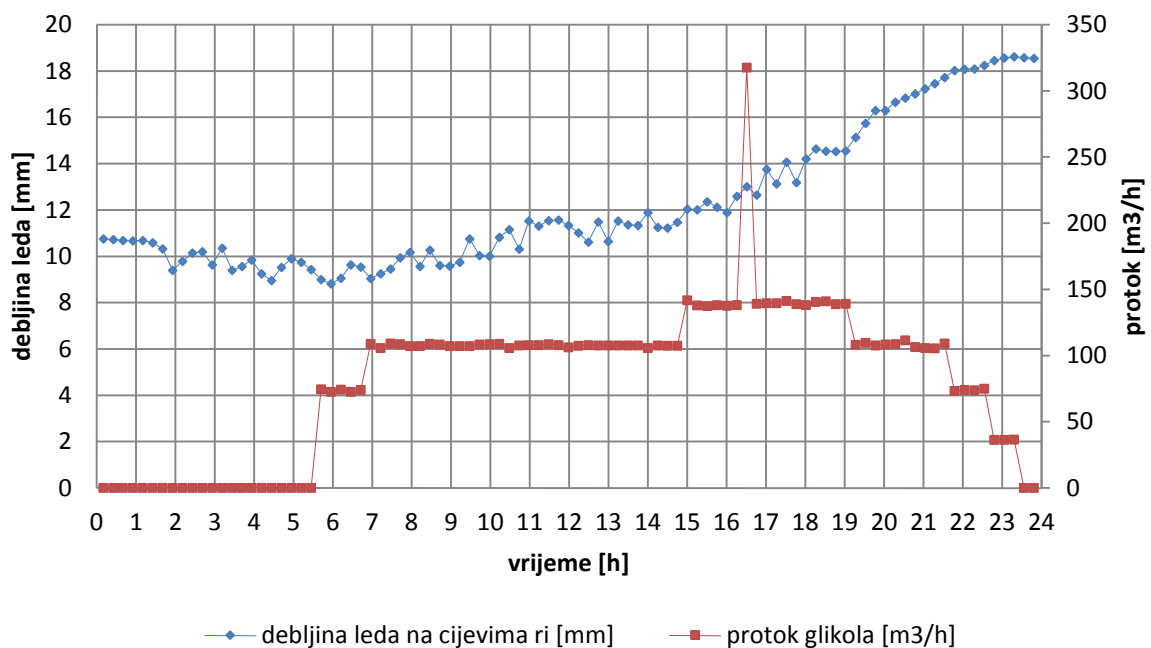

Slika 5. Akumulirani led na cijevima u ovisnosti o protoku propilen glikola kroz cijevi

Sa slike 5 vidimo da akumulacija leda u silosu počinje otvaranjem ventila i puštanjem propilen glikola u cirkulaciju kroz cijevi modula.

Protok propilen glikola se postepeno povećava u odnosu na dovedeno toplinsko opterećenje od potrošača kako bi se održala kontinuirana akumulacija leda. Pred kraj procesa akumulacije protok propilen glikola se smanjuje. Što je protok propilen glikola veći, to je stvaranje leda brže.

3.2. Ovisnost akumulacije leda o ulaznoj temperaturi propilen glikola u silos (27.9.2013.)

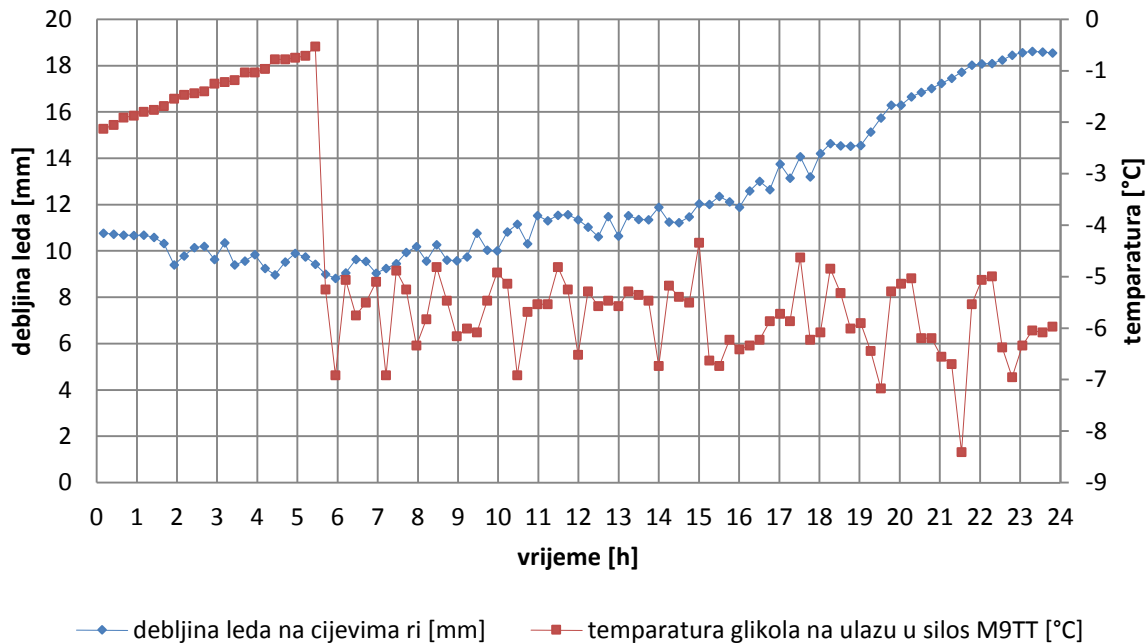

Slika 6. Akumulirani led u ovisnosti o ulaznoj temperaturi propilen glikola u silos

Temperatura propilen glikola se prilikom stvaranja leda drži u određenom rasponu bez prevelikih oscilacija.

Sa slike 6 vidimo kako prilikom akumulacije leda ulazna temperatura propilen glikola u modul oscilira između -7°C i -4°C .

Kada je ulazna temperatura propilen glikola niža akumulacija leda je brža, a kada je viša akumulacija leda je sporija. U razdoblju 6-18 sati imamo približno linearnu akumulaciju, nakon čega možemo vidjeti malo brže punjenje uzrokovano snižavanjem temperatura propilen glikola.

3.3. Ovisnost akumulacije leda o protoku tople vode od potrošača (27.9.2013.)

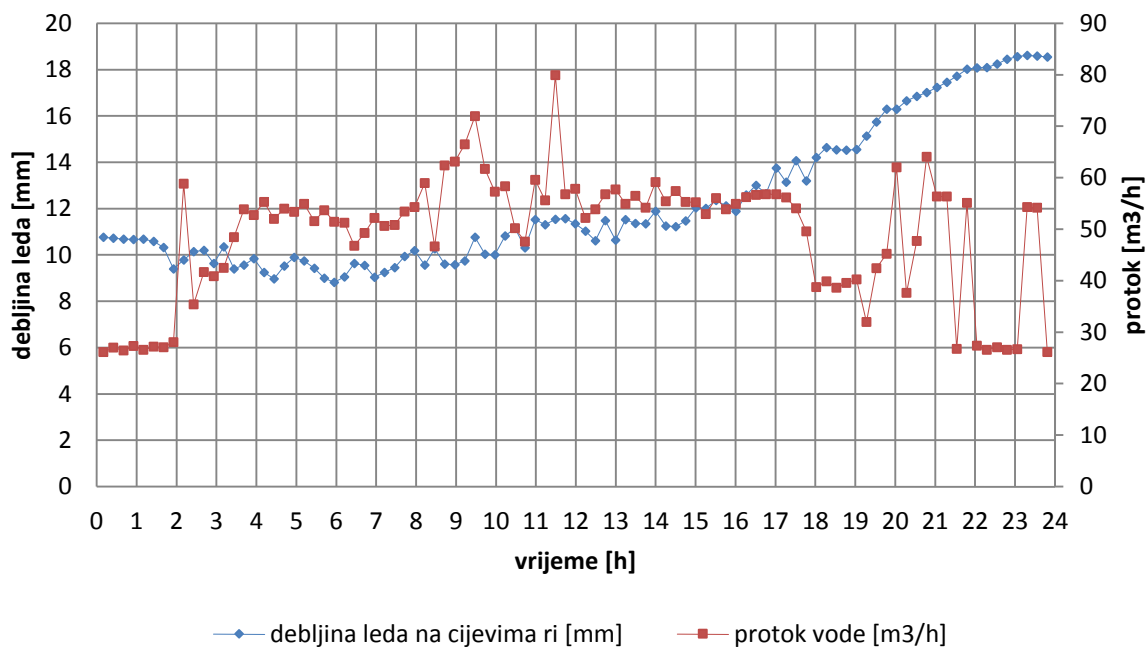

Slika 7. Akumulirani led u ovisnosti o protoku tople vode prema silosu

Led se akumulira u periodu kada je toplinsko opterećenje od potrošača najmanje. Stoga je logično da protok tople vode u tome periodu opada što se i vidi sa slike 7.

Što se protok tople vode brže smanjuje u vremenu to je i akumulacija leda brža.

3.4. Ovisnost akumulacije leda o ulaznoj i izlaznoj temperaturi vode u silosu (27.9.2013.)

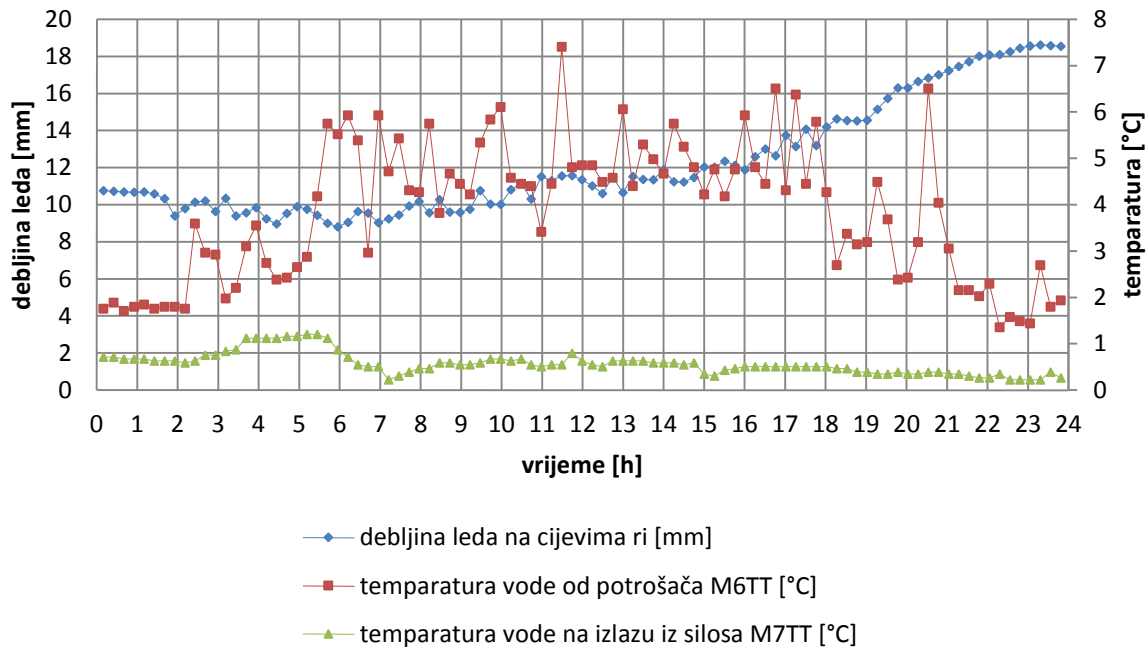

Slika 8. Akumulirani led u ovisnosti o temperaturi vode na ulazu u silos

Led se akumulira u periodu najmanjeg toplinskog opterećenja silosa. Iz tog razloga su u tom periodu protok i temperature vode u padu što se vidi sa slike 8. Tada se sav toplinski tok od vode predaje glikolu koji preuzima na sebe više topline nego što dobiva od vode što rezultira stvaranjem leda na stijenkama cijevi.

3.5 Ovisnost akumulacije leda o kA produktu (koeficijent prolaza topline i površina prijenosa topline) (27.9.2013.)

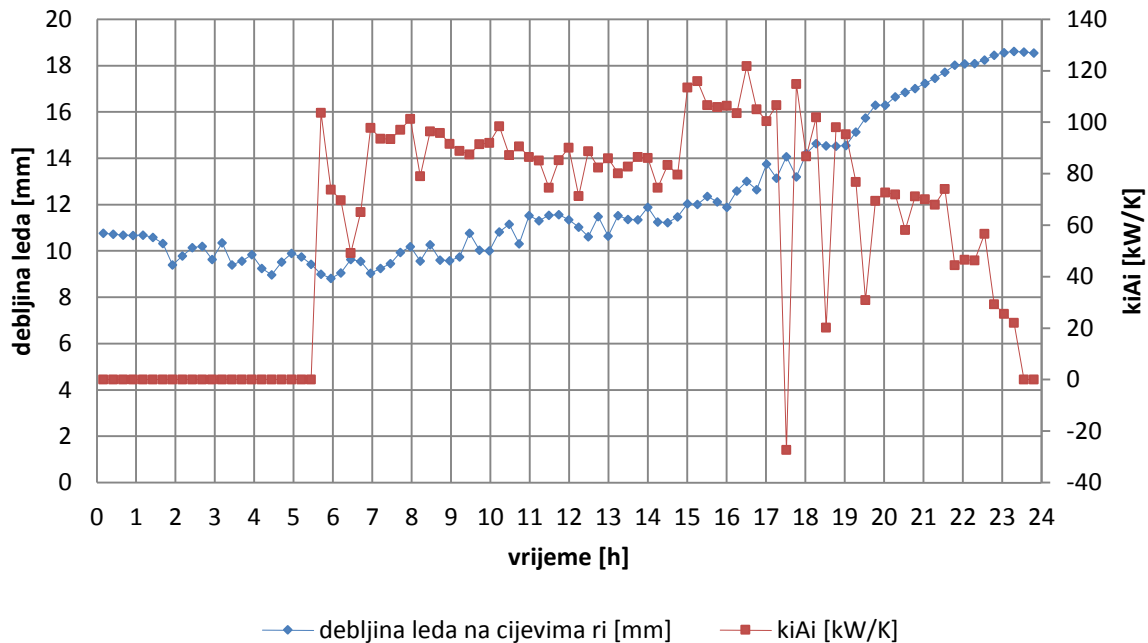

Slika 9. Produkt koeficijenta prolaza topline i površine leda u ovisnosti o akumulaciji leda u silosu

kA produkt prilikom akumulacije pada jer nam raste debljina stvorenoga leda na cijevima koji predstavlja toplinski otpor prolazu topline prema rashladnom mediju, uz to se prema kraju procesa akumulacije smanjuje i protok propilen glikola što također utječe na koeficijent prolaza topline. Na slici 10 u 15 h imamo skok kA produkta jer se u tom trenutku naglo poveća odvođenje topline propilen glikolom.

3.5.1. Proračun kA produkta

Slučaj leda na cijevima:

Bilanca mase vode (vremenska promjena mase leda u silosu jednaka je razlici ulaznog i izlaznog masenog protoka vode):

$$\frac{\Delta m_i^{cv}}{\Delta t} = \dot{m}_{w,in}^{cv} - \dot{m}_{w,out}^{cv} \quad (3)$$

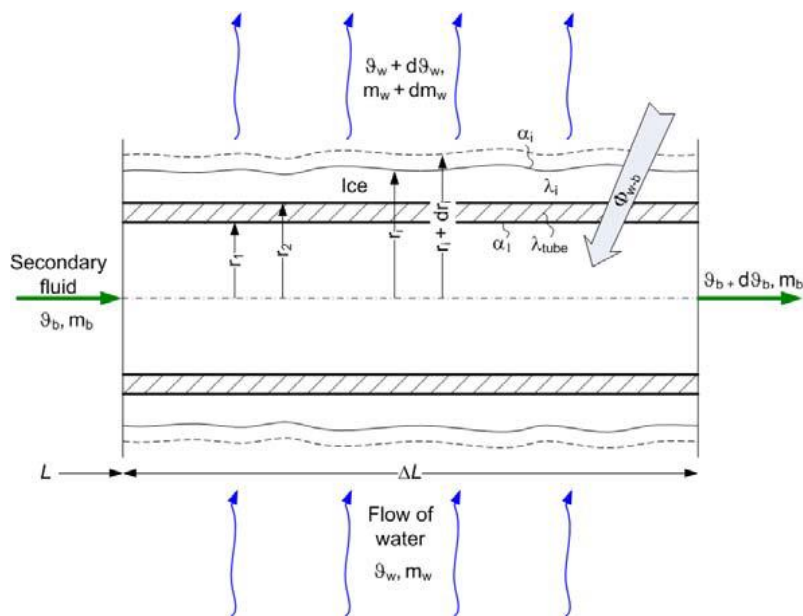

Slika 10. Kontrolni volumen prikazan kao segment promatrane cijevi (Marino Grozdek, 2009)

Prijenos topline sa vode na led i s leda na propilen glikol (prema Marino Grozdek, 2009):

$$c_{pw} \dot{m}_w^{cv} \Delta \vartheta_w = \alpha_i \Delta A_i^{cv} (\vartheta_{w,m} - 0) \quad (4)$$

$$c_{pb} \dot{m}_b^{cv} \Delta \vartheta_b = k_i A_i^{cv} (0 - \vartheta_{b,m}) \quad (5)$$

Koeficijent prolaza topline, sveden na vanjsku površinu leda $A_i^{cv} = 2r_i^{cv} \pi \Delta L^{cv}$ (sastoji se od konvekcije na strani propilen glikola, provođenja topline kroz cijev te provođenja topline kroz led)

$$\frac{1}{k_i} = \frac{r_i}{r_1 \alpha_1} + \frac{r_i}{\lambda_t} \ln \left(\frac{r_2}{r_1} \right) + \frac{r_i}{\lambda_i} \ln \left(\frac{r_i}{r_2} \right) \quad (6)$$

3.6. Ovisnost akumulacije o ukupnom predanom toplinskom toku (ukupna toplina dovedena silosu) (27.9.2013.)

Ukupni toplinski tok doveden silosu:

$$\Phi_{uk} = \Phi_w - \Phi_b \quad (7)$$

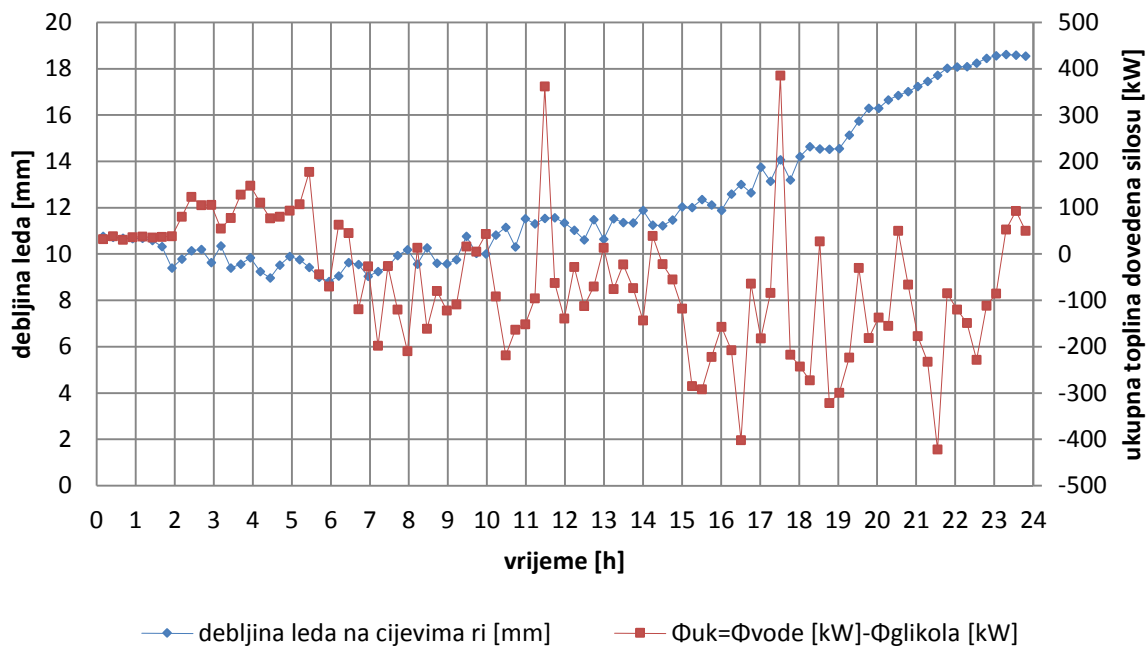

Slika 11. Ovisnost akumulacije o ukupnom dovedenom toplinskom toku

Sa slike 11 vidi se unos rashladne energije u silos.

Kada su vrijednosti ukupnog toplinskog toka veće od nule led se topi a kada su manje od nule led se akumulira. Rashladna energija koja se dovodi silosu je razlika dovedene toplinske energije toplom vodom i odvedene energije propilen glikolom.

Propilen glikol preuzima cjelokupno toplinsko opterećenje od potrošača i nastavlja dalje odvoditi toplinu što rezultira stvaranjem leda tj. akumulacijom na cijevima.

4. TOPLJENJE LEDA (25.9.2013.)

(Preuzeto iz Marino Grozdek, 2009):

Dovedena toplinska energija od potrošača:

$$\Phi_{in} = \dot{m}_w c_{pw} (\vartheta_{w,in} - \vartheta_{w,out}) \quad (8)$$

Osjetna toplinska energija zbog promjene temperature glavnine tople vode:

$$\Phi_{w,\vartheta} = M_w c_{pw} \frac{d\vartheta_w}{dt} = \dot{m}_w c_{pw} (\vartheta_{w,silo\ down} - \vartheta_{w,out}) \quad (9)$$

Osjetna toplinska energija zbog promjene mase vode u silosu:

$$\Phi_{w,M} = c_{pw} (\vartheta_w - \vartheta_{ice}) \frac{dM_w}{dt} = c_{pw} (\vartheta_{w,m} - \vartheta_{ice}) \frac{\Delta M_w}{\Delta t} \quad (10)$$

Toplinska energija prenesena s vode na led:

$$\Phi_{w,ice} = \alpha A_{ice} (\vartheta_w - \vartheta_{ice}) = \alpha A_{ice} (\vartheta_{w,m} - \vartheta_{ice}) \quad (11)$$

Dovedena toplinska energija od potrošača se može prikazati i drugim načinom:

$$\Phi_{in} = \Phi_{w,\vartheta} + \Phi_{w,M} + \Phi_{w,ice} \quad (12)$$

$\vartheta_{w,silo\ down}$ - temperatura vode na dnu silosa (pomiješana topla voda od potrošača i hladna voda u silosu)

$\vartheta_{w,m}$ - srednja temperatura vode u silosu- $(\vartheta_{w,in} + \vartheta_{w,out}) * 0.5$

ϑ_{ice} - temperatura leda- uzeta vrijednost 0 °C

$\frac{\Delta M_w}{\Delta t}$ - promjena mase vode je jednaka promjeni mase leda u vremenu

4.1. Ovisnost topljenja leda o protoku propilen glikola kroz cijevi (25.9.2013.)

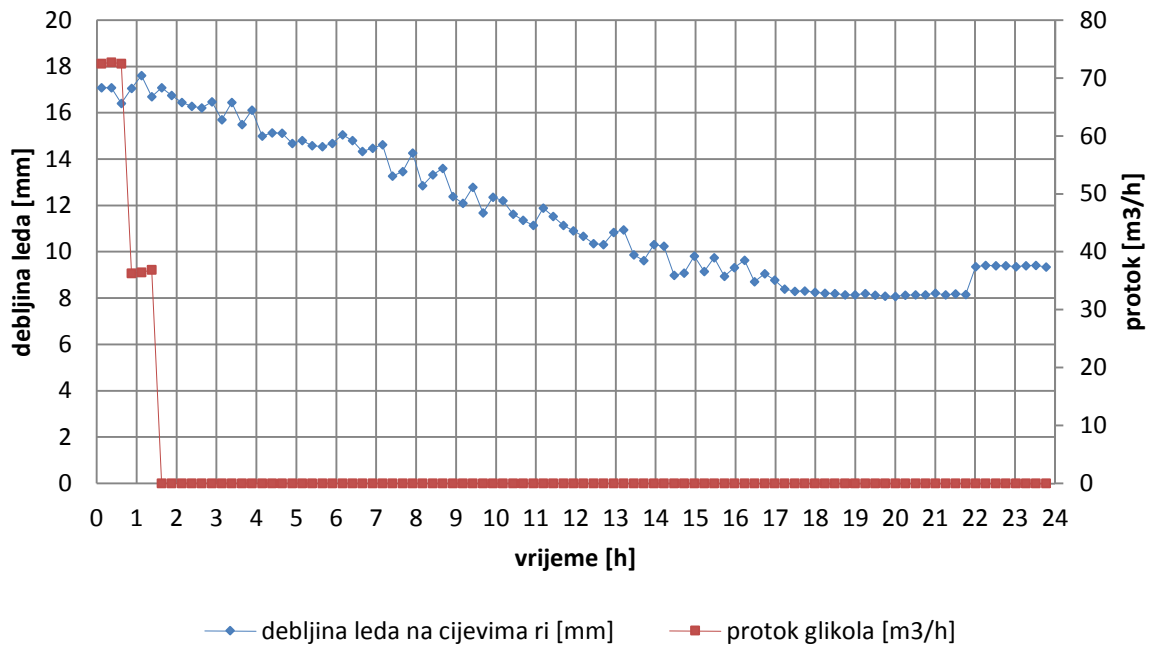

Slika 12. Topljenje leda u ovisnosti o protoku glikola

Topljenje leda kreće kada završi proces akumulacije tj. protok propilen glikola se spusti na nulu.

Vidimo na slici 12 da se to događa između 1-2 sata ujutro što će nam objasniti početne niske vrijednosti αA produkta za ovaj dan u istome vremenu.

4.2. Ovisnost topljenja leda o protoku tople vode od potrošača (25.9.2013.)

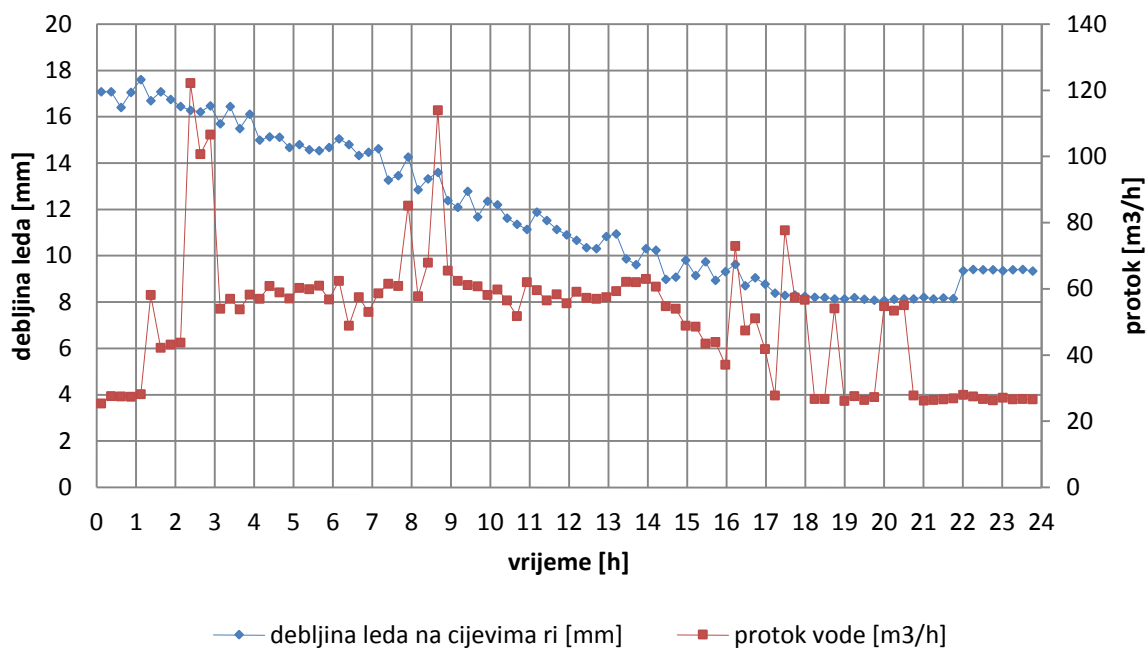

Slika 13. Topljenje leda u ovisnosti o protoku tople vode od potrošača

Protok tople vode od potrošača ima porast prilikom topljenja leda kao što se vidi na slici 13. Ima maksimume u periodima najvećeg toplinskog opterećenja silosa. Time se želi iskoristiti najviše akumulirane rashladne energije bez prevelikog porasta temperature vode.

4.3. Ovisnost topljenja leda o ulaznoj i izlaznoj temperaturi vode u silosu (25.9.2013.)

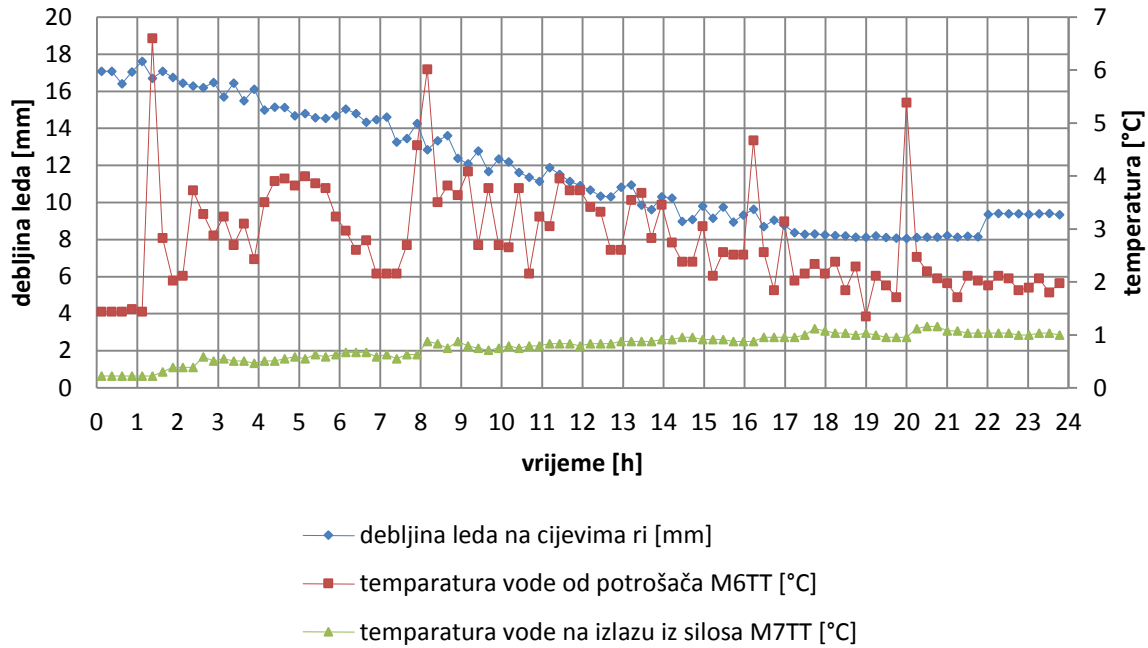

Slika 14. Topljenje leda u ovisnosti o temperaturi vode na ulazu i izlazu iz silosa

U procesu topljenja leda, prema slici 14, vidimo da temperature vode na ulazu i izlazu iz silosa rastu. Kako se troši rashladna energija akumulirana u silosu vodi pada koeficijent prijelaza topline i površina izmjene topline (tj. debljina leda na cijevima), te time voda ne može prenijeti sav toplinski tok ledu čime joj raste temperatura. Što je temperatura tople vode na ulazu u silos veća topljenje leda je brže.

4.4. Ovisnost topljenja leda o ukupnom predanom toplinskom toku (ukupna toplina dovedena silosu) (25.9.2013.)

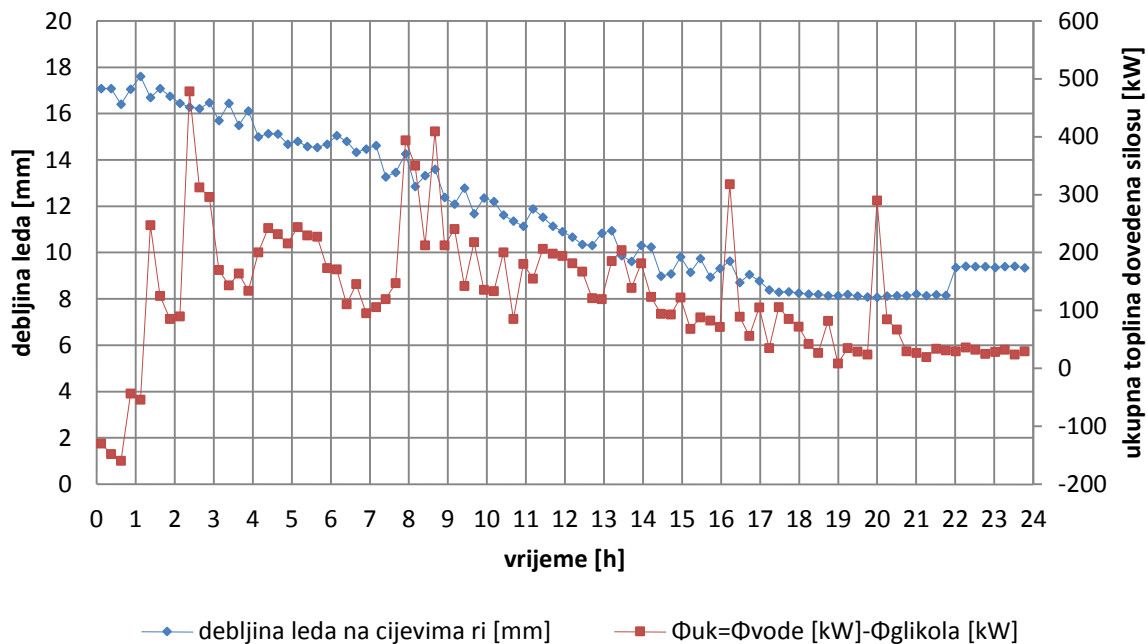

Slika 15. Topljenje leda u ovisnosti o ukupnom dovedenom toplinskom toku

Na slici 15 protok propilen glikola pada na nulu između 1 i 2 sata ujutro čime se prestaje odvoditi toplinski tok od silosa. Tada nam preostaje samo toplinsko opterećenje od potrošača kojime se tada troši led nastao u procesu akumulacije. Led se topi približno linearno kroz većinu procesa do negdje 16 sati kada se opterećenje smanjuje i led ostaje približno konstantan. Možemo zaključiti da što je temperaturno opterećenje više led se brže topi.

4.5. Toplinsko opterećenje silosa prilikom topljenja leda(25.9.2013.)

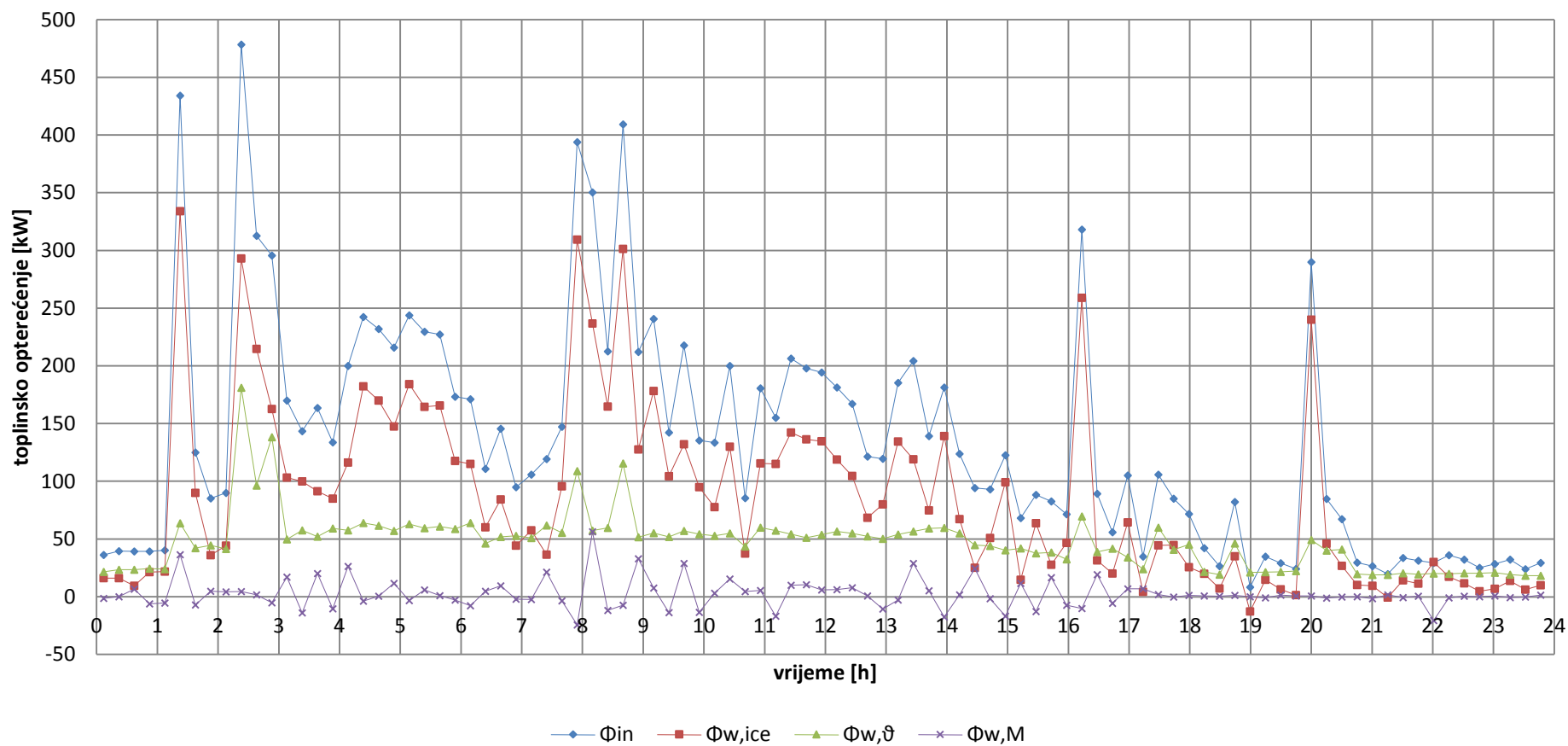

Slika 16. Toplinsko opterećenje u procesu topljenja leda

Maksimalna potreba za rashladnom energijom (480kW) je skoro tri puta veća od srednje vrijednosti (136kW), prema slici 16.

4.6. Izlazna temperatura vode iz silosa (25.9.2013.)

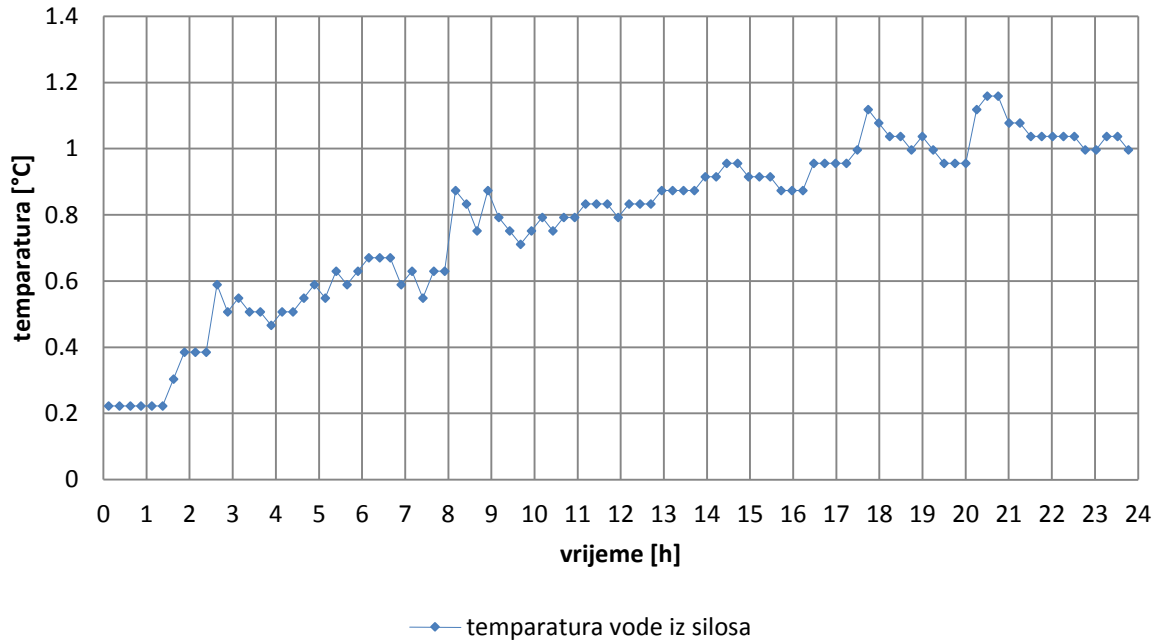

Slika 17. Temperatura izlazne vode iz silosa

Vidljivo sa slike 17, temperatura vode iz silosa tijekom cijelog postupka topljenja leda raste sa trošenjem akumulirane energije u ledu, αA umnožak nije dovoljno visok za prenošenje cjelokupnog toplinskog toka od potrošača pa se to odražava porastom temperature vode.

4.7. Ovisnost topljenja leda o αA produktu (25.9.2013.)

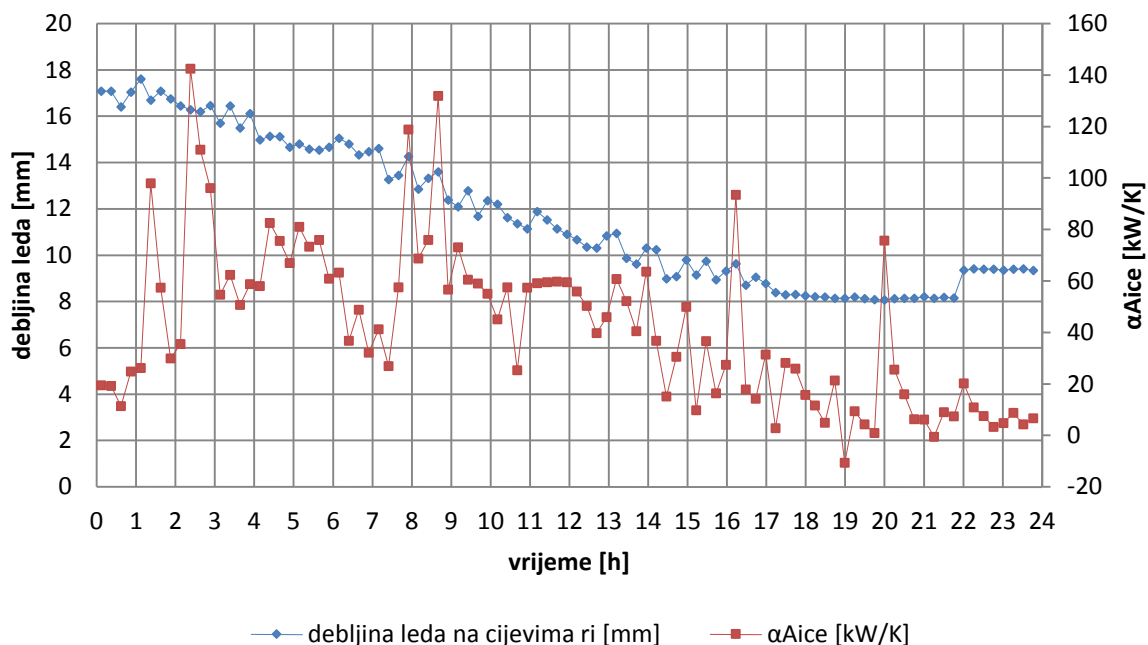

Slika 18. αA produkt u ovisnosti o topljenju leda u vremenu

αA produkt ima tendenciju pada s vremenom i smanjenjem postotka leda u silosu, kao što s vidi sa slike 18. αA se smanjuje sa smanjenjem postotka leda zbog toga što pada površina poprečnog presjeka leda na cijevima te se time otvara protok vodi oko cijevi koja zatim ima manje brzine (čime se smanjuje vrijednost koeficijenta prijelaza topline).

5. AKUMULACIJA/TOPLJENJE LEDA(17.9.2013.)

5.1. Ovisnost akumulacije leda o protoku propilen glikola kroz cijevi (17.9.2013.)

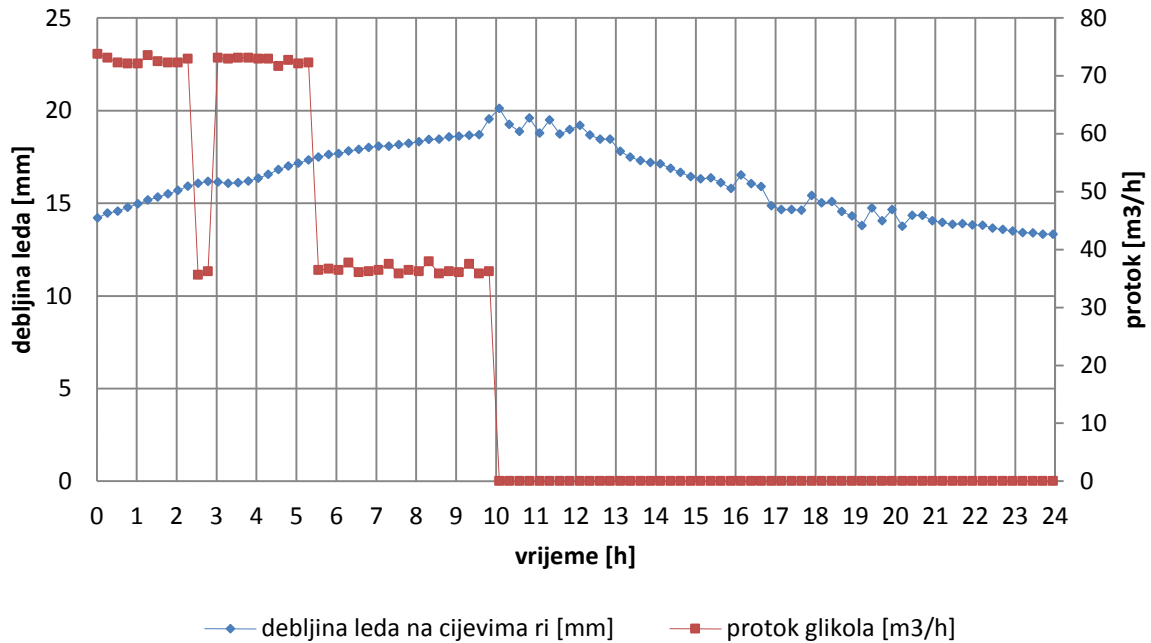

Slika 19. Ovisnost akumulacije leda o protoku propilen glikola kroz cijevi

5.2. Ovisnost akumulacije leda o ulaznoj temperaturi propilen glikola u silos (17.9.2013.)

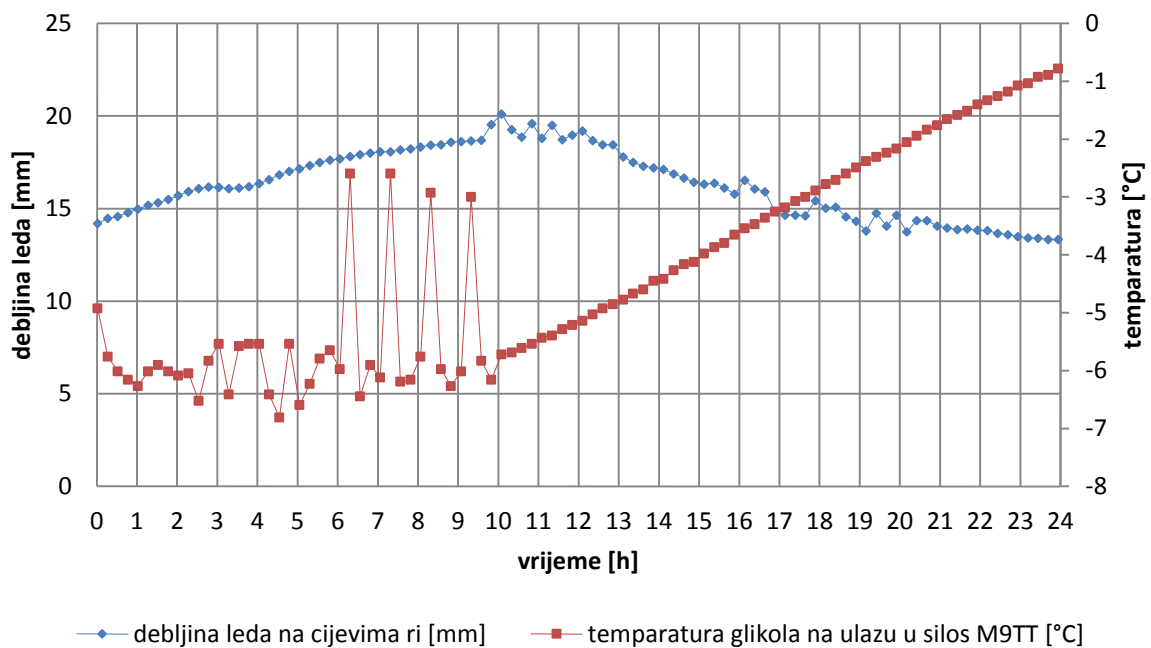

Slika 20. Ovisnost akumulacije leda o ulaznoj temperaturi propilen glikola u silos

5.3. Ovisnost akumulacije leda o protoku tople vode od potrošača (17.9.2013.)

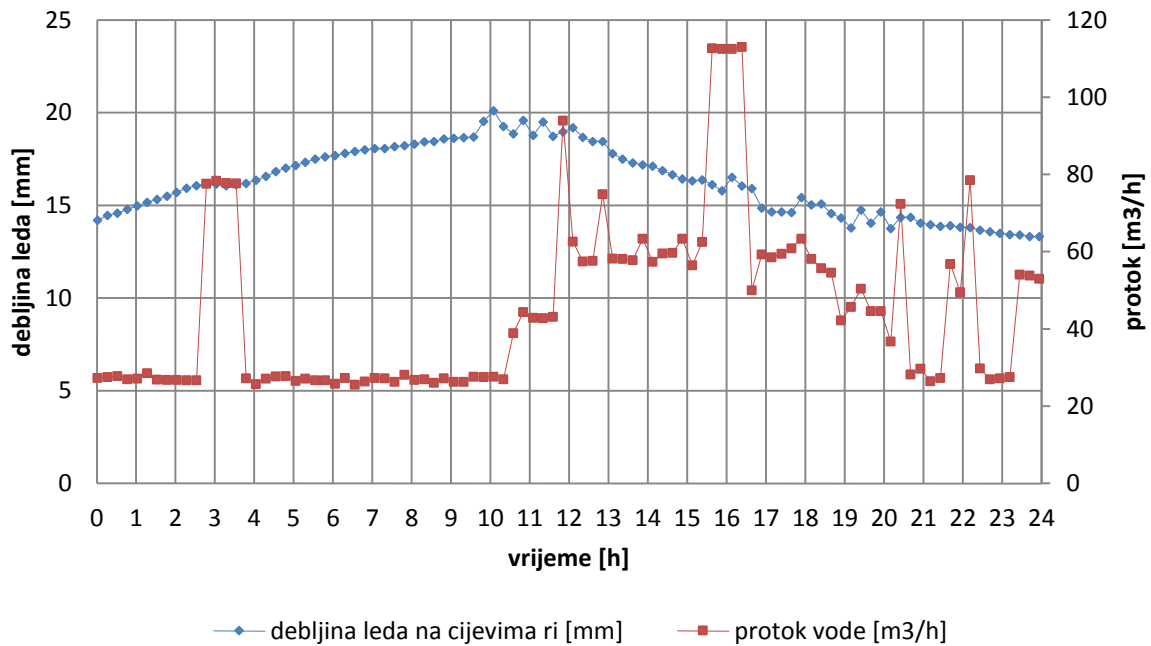

Slika 21. Ovisnost akumulacije leda o protoku tople vode od potrošača

5.4. Ovisnost akumulacije leda o ulaznoj i izlaznoj temperaturi vode u silosu (17.9.2013.)

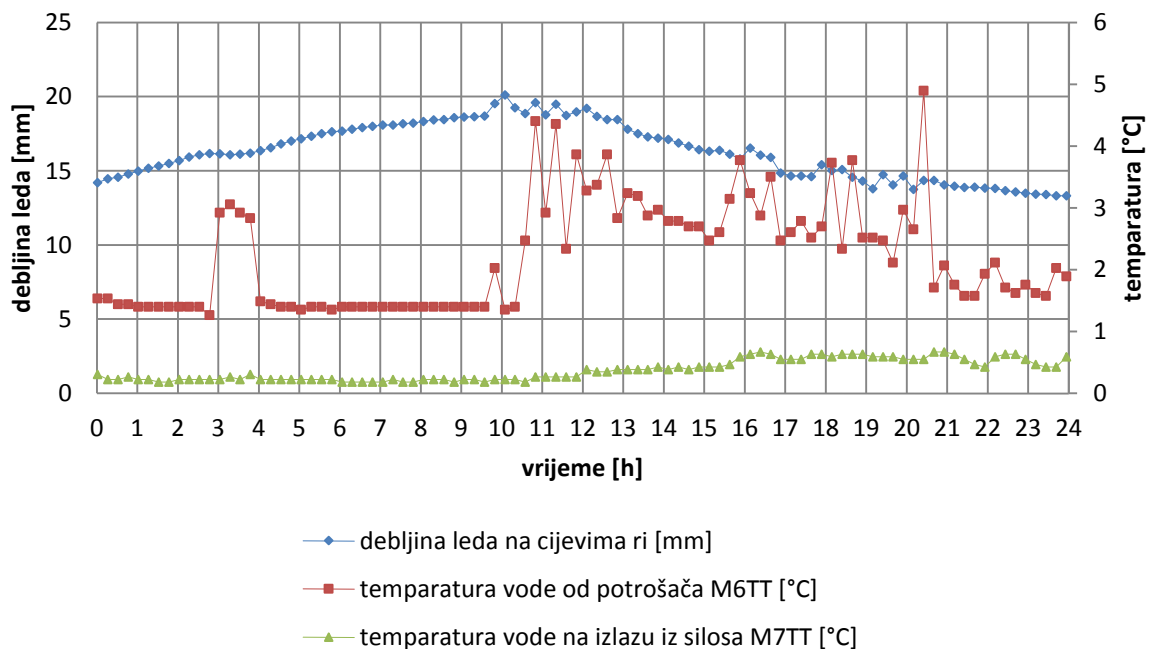

Slika 22. Ovisnost akumulacije leda o ulaznoj i izlaznoj temperaturi vode u silosu

5.5. Ovisnost akumulacije o ukupnom predanom toplinskom toku (ukupna toplina dovedena silosu) (17.9.2013.)

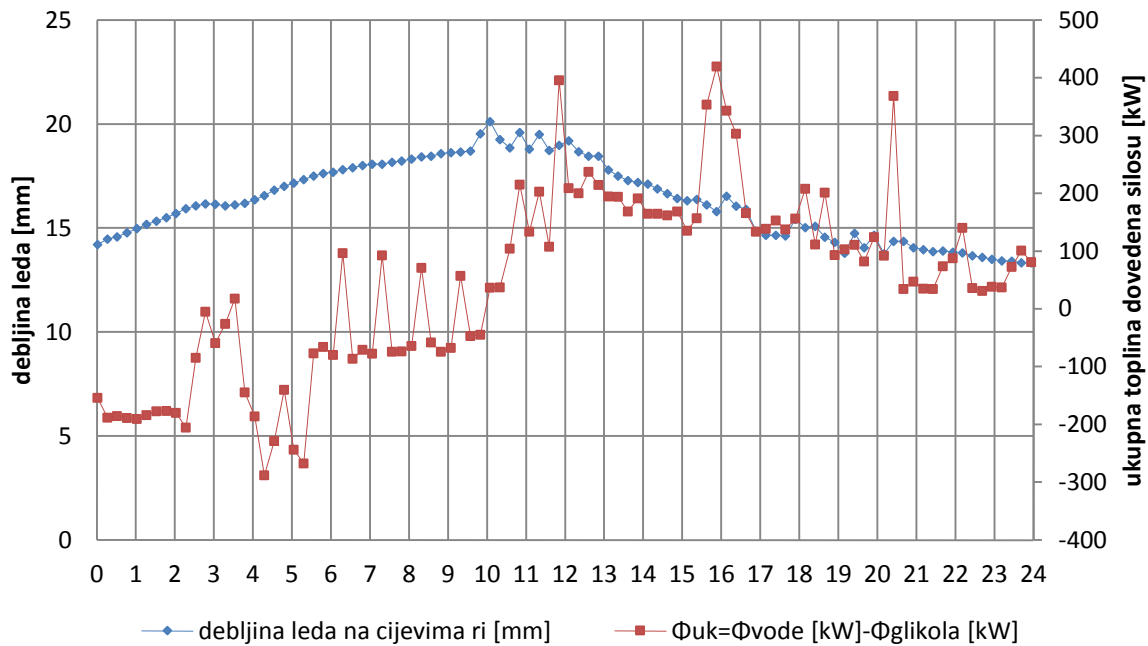

Slika 23. Ovisnost akumulacije o ukupnom dovedenom toplinskom toku

5.6. Ovisnost akumulacije leda o kA produktu (17.9.2013.)

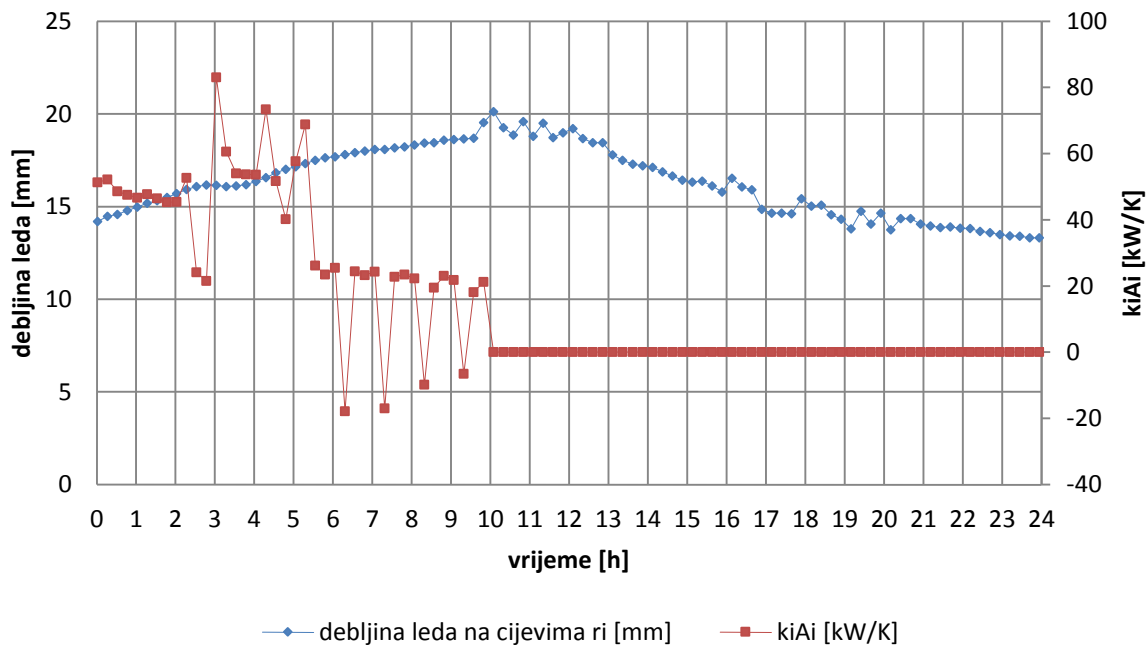

Slika 24. Ovisnost akumulacije leda o kA produktu

5.7. Toplinsko opterećenje silosa prilikom topljenja leda (17.9.2013.)

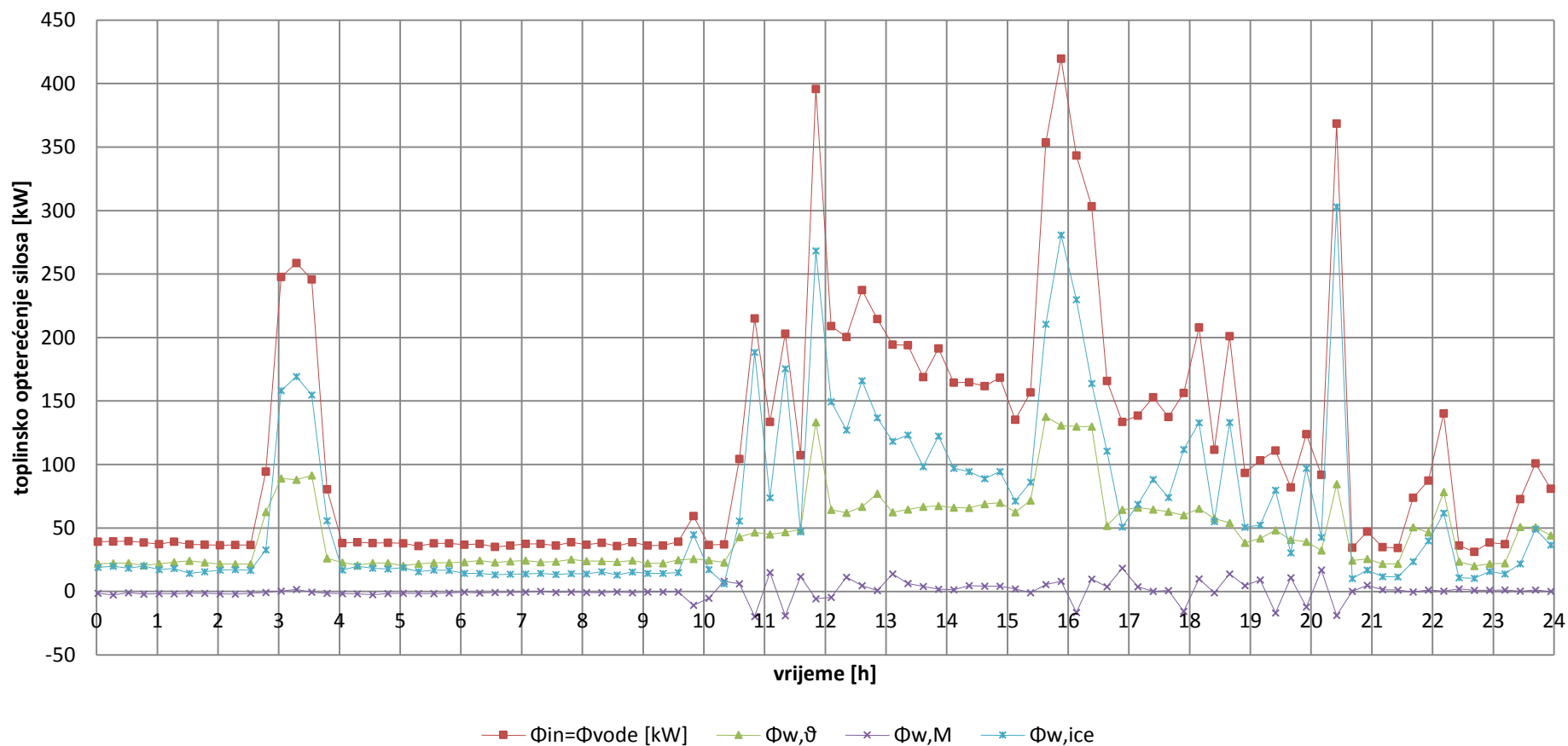

Slika 25. Toplinsko opterećenje u procesu topljenja leda

5.8. Ovisnost topljenja leda o αA produktu (17.9.2013.)

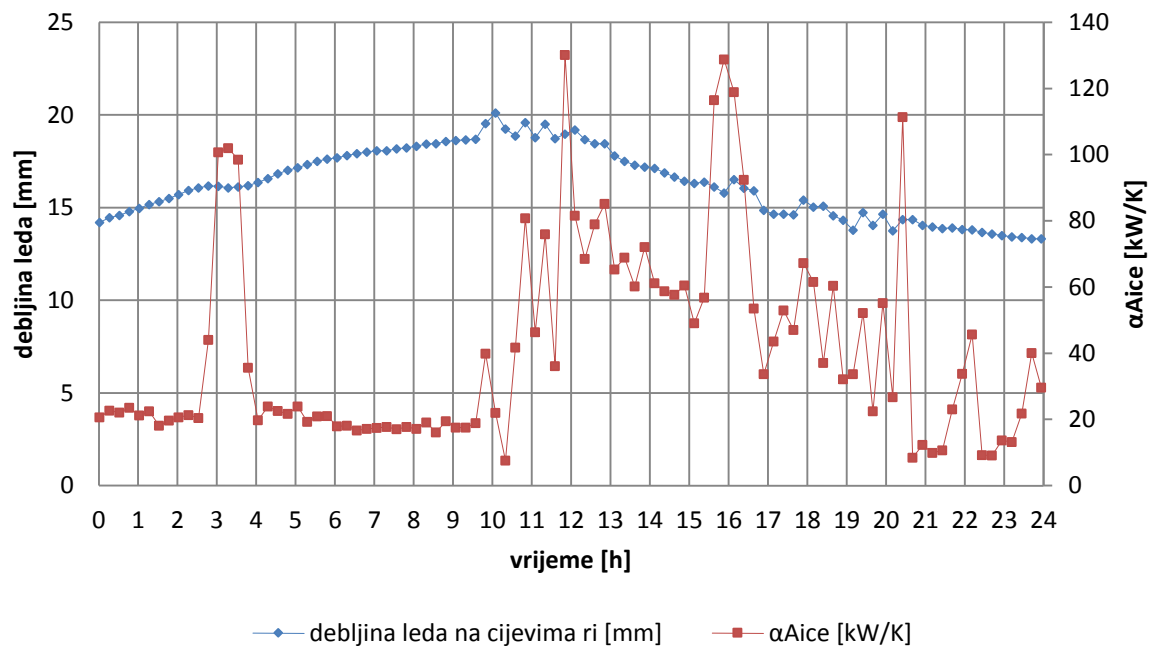

Slika 26. αA produkt u ovisnosti o topljenju leda u vremenu

5.9. Izlazna temperatura vode iz silosa (17.9.2013.)

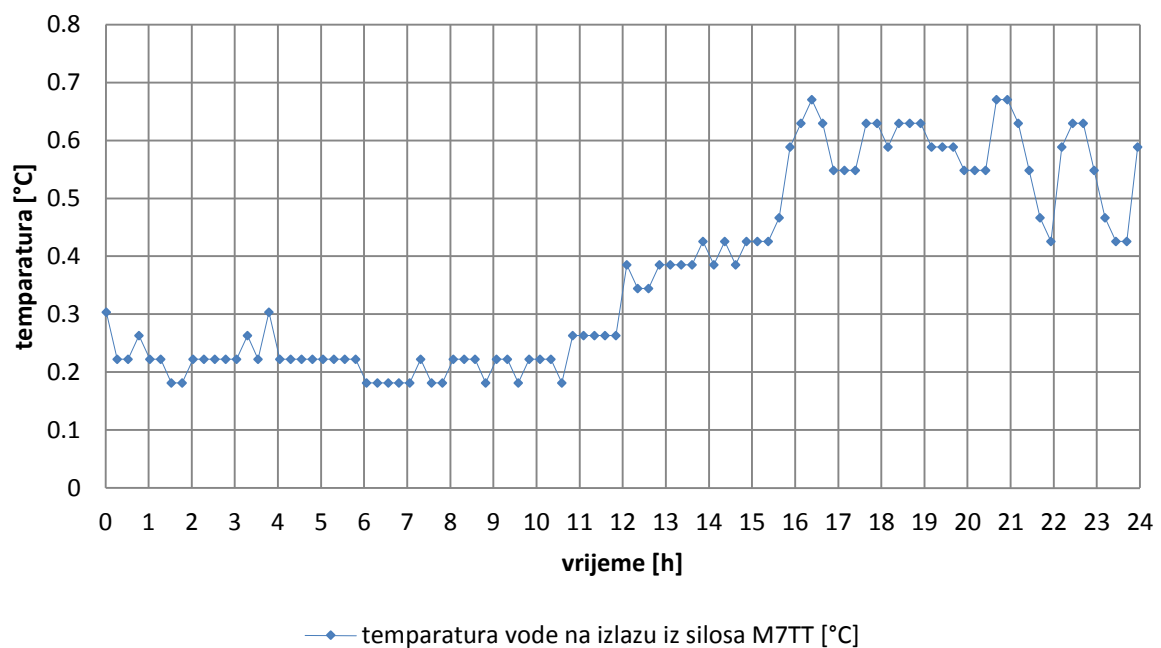

Slika 27. Temperatura izlazne vode iz silosa

6. ZAKLJUČAK

Proučavanjem eksperimentalnih podataka rada silosa tijekom vremena dobivena je predodžba o radu sustava u duljem vremenskom razdoblju. Podaci pokazuju promjenjivost učinka akumulacije i topljenja povezanu sa dosta parametara.

U procesu punjenja, na slikama u poglavlju 3 i 5, vidimo kako se led dosta linearno akumulira s laganim usporavanjem pred kraj akumulacije.

Temperatura propilen glikola se drži približno konstantnom bez prevelikih oscilacija, dok se tada učin akumulacije podešava promjenjivim protokom propilen glikola.

Kako se količina leda u silosu povećava vidimo da nam produkt kA pada što možemo zaključiti da se događa zbog povećanog otpora prolazu topline u obliku leda.

Prilikom pražnjenja silosa tj. topljenja leda, prema poglavlju 4 i 5, isto se vidi približno linearna karakteristika topljenja leda.

Brže topljenje je na početku procesa te se usporava pred kraj kako se gradijent temperature između vode i leda smanjuje.

Toplinsko opterećenje je dosta dinamično, ima maksimume preko 450 kW uz osrednjene vrijednosti od 100-150 kW. Što je veće toplinsko opterećenje silosa imamo brže topljenje leda.

α_{ice} produkt određuje topljenje leda u silosu, što je on viši to su konačne temperature vode na izlazu iz silosa niže.

LITERATURA

- [1] Marino Grozdek (2009): *Load shifting and Storage of Cooling Energy through Ice Bank or Ice Slurry Systems*
- [2] Charles E. Dorgan, James S. Ellesen (1993): *Design guide for Cool Thermal Storage.*
- [3] Frigoterm d.o.o: *Icebank silo Byrkjelo PLC manual*

TABLICA 1. PODACI za proces akumulacije leda 27.9.2013

Time String	Time String	debljina leda na cijevima r _i [mm]	protok vode [m ³ /h]	temparat			protok glikola [m ³ /h]	temparat		Φ _{in} =Φ _{vo} de [kW]	Φ _{out} =Φ _g ikola [kW]	Φ _{uk} =Φ _{vo} de [kW]- Φ _g likola [kW]	kiA _i [kW/K]	αA _{ice} [kW/K]	masa leda u silosu [kg]	vremenska promjena mase leda u silosu ΔM _w /Δt [kg/h]	Φ _{w,θ}	Φ _{w,M}	Φ _{w,ice}	
				temparat od potrošača M6TT [°C]	temparat ura vode na ulazu u silos M14TT [°C]	temparat ura vode na izlazu iz silosa M7TT [°C]		temparat ura glikola na ulazu u silos M9TT [°C]	temparat ura glikola iz silosa M10TT [°C]											
27.9.2013	0:10:00	0,17	10,76061	26,14583	1,754917	1,337383	0,711113	0	-2,12486	1,059723	31,96853	0	31,96853	0	9,998287	26836,97	373,36	19,10341	0,537085	12,32804
27.9.2013	0:25:05	0,42	10,72319	26,97917	1,889469	1,337383	0,711113	0	-2,05223	1,059723	38,52736	0	38,52736	0	14,03436	26743,64	373,32	19,71229	0,566329	18,24875
27.9.2013	0:40:11	0,67	10,68577	26,45833	1,710068	1,302082	0,670368	0	-1,90698	1,168922	30,9606	0	30,9606	0	9,193641	26650,31	373,32	19,49977	0,518388	10,94244
27.9.2013	0:55:16	0,92	10,66706	27,29167	1,79977	1,266781	0,670368	0	-1,87066	1,205326	36,10603	0	36,10603	0	13,6406	26603,64	186,68	18,98995	0,26899	16,84709
27.9.2013	1:10:21	1,17	10,68577	26,5625	1,84462	1,266781	0,670368	0	-1,79803	1,278126	37,80439	0	37,80439	0	15,58312	26650,31	-186,68	18,48258	-0,27387	19,59568
27.9.2013	1:25:26	1,42	10,59221	27,1875	1,754917	1,23148	0,629631	0	-1,76172	1,314526	35,83714	0	35,83714	0	12,95755	26416,97	933,36	19,0899	1,298291	15,44895
27.9.2013	1:40:32	1,68	10,33025	27,08333	1,79977	1,23148	0,629631	0	-1,68909	1,314526	37,12281	0	37,12281	0	11,85695	25763,65	2613,28	19,01675	3,703411	14,40264
27.9.2013	1:55:37	1,93	9,394683	28,02083	1,79977	1,23148	0,629631	0	-1,54384	1,350925	38,40783	0	38,40783	0	4,532967	23430,34	9333,24	19,67503	13,22661	5,506197
27.9.2013	2:10:42	2,18	9,787621	58,85416	1,754917	1,23148	0,58889	0	-1,47121	1,387329	80,3872	0	80,3872	0	35,51861	24410,33	-3919,96	44,12227	-5,35945	41,62438
27.9.2013	2:25:48	2,43	10,14314	35,41667	3,59375	1,266781	0,629631	0	-1,4349	1,423729	122,9715	0	122,9715	0	49,90426	25296,98	-3546,6	26,32669	-8,73754	105,3824
27.9.2013	2:40:53	2,68	10,19927	41,66666	2,965855	1,372684	0,751854	0	-1,39858	1,460129	105,3423	0	105,3423	0	41,08853	25436,99	-560,04	30,17924	-1,21454	76,3776
27.9.2013	2:55:58	2,93	9,637928	40,83333	2,921005	1,337383	0,751854	0	-1,25333	1,496529	105,7029	0	105,7029	0	35,83636	24036,99	5600	27,89395	11,99801	65,81094
27.9.2013	3:11:03	3,18	10,34896	42,5	1,979168	1,478588	0,833332	0	-1,21701	1,532928	54,81154	0	54,81154	0	24,50134	25810,31	-7093,28	31,99394	-11,6374	34,44501
27.9.2013	3:26:09	3,44	9,394683	48,4375	2,203415	1,549191	0,874073	0	-1,1807	1,532928	77,73734	0	77,73734	0	14,61974	23430,34	9519,88	38,1512	17,0901	22,49604
27.9.2013	3:41:14	3,69	9,563084	53,85416	3,100407	1,725693	1,118523	0	-1,03545	1,569332	127,8548	0	127,8548	0	44,48562	23850,33	-1679,96	38,1484	-4,13445	93,84085
27.9.2013	3:56:19	3,94	9,843756	52,70833	3,548901	1,690395	1,118523	0	-1,03545	1,642132	147,2872	0	147,2872	0	51,3107	24550,32	-2799,96	35,16615	-7,62335	119,7444
27.9.2013	4:11:24	4,19	9,244988	55,3125	2,741608	1,655094	1,118523	0	-0,96282	1,642132	110,7095	0	110,7095	0	32,45155	23057	5973,28	34,6256	13,45029	62,63361
27.9.2013	4:26:30	4,44	8,964318	51,97917	2,382813	1,655094	1,118523	0	-0,78125	1,678532	76,97985	0	76,97985	0	22,1185	22357,01	2799,96	32,53893	5,718767	38,72215
27.9.2013	4:41:35	4,69	9,525662	53,95833	2,427662	1,690395	1,15926	0	-0,78125	1,678532	80,17087	0	80,17087	0	31,93861	23617	-5039,96	33,43568	-10,5455	57,28065
27.9.2013	4:56:40	4,94	9,899891	53,33333	2,651909	1,690395	1,15926	0	-0,74494	1,751335	93,25187	0	93,25187	0	36,60205	24690,33	-4293,32	33,0484	-9,54483	69,7483
27.9.2013	5:11:46	5,20	9,750196	54,89583	2,876156	1,725693	1,200001	0	-0,70862	1,714931	107,5199	0	107,5199	0	34,49378	24316,99	1493,36	33,66802	3,550849	70,30104
27.9.2013	5:26:51	5,45	9,432104	51,5625	4,176792	1,725693	1,200001	0	-0,52705	1,751335	177,3367	0	177,3367	0	50,49857	23523,67	3173,28	31,62366	9,952874	135,7602
27.9.2013	5:41:56	5,70	9,00174	53,64583	5,746529	1,796295	1,118523	74,58333	-5,24783	-1,26991	293,6429	337,7903	-44,1474	103,6527	68,18018	22450,34	4293,32	42,41958	17,19309	234,0302
27.9.2013	5:57:01	5,95	8,814628	51,45833	5,522282	1,584492	0,874073	72,70834	-6,91826	-2,65312	282,8868	353,0743	-70,1875	73,77709	72,9391	21983,68	1866,64	42,6498	6,96482	233,2722
27.9.2013	6:12:07	6,20	9,057876	51,25	5,925926	1,443287	0,711113	74,16666	-5,06626	-2,10712	313,0644	249,8756	63,1888	69,66748	83,97766	22590,34	-2426,64	43,7779	-9,39499	278,6815
27.9.2013	6:27:12	6,45	9,637928	46,77083	5,38773	1,372684	0,548149	72,70834	-5,75622	-3,08993	262,9132	217,7065	45,2067	49,2206	80,17627	24036,99	-5786,6	44,99155	-20,0367	237,9583
27.9.2013	6:42:19	6,71	9,544374	49,27083	2,965855	1,302082	0,507412	73,95833	-5,50203	-2,43472	139,3013	258,2811	-118,98	65,08486	52,80209	23803,67	933,28	45,67973	1,890893	91,73068
27.9.2013	6:57:25	6,96	9,039165	52,1875	5,925926	1,407986	0,507412	108,9583	-5,10257	-2,21632	331,2438	358,0506	-26,8068	97,84288	80,05117	22543,68	5039,96	54,83182	18,91386	257,4981
27.9.2013	7:12:30	7,21	9,244988	50,625	4,714989	1,23148	0,222221	105,625	-6,91826	-3,01713	266,4281	464,7661	-198,338	93,55772	86,1751	23057	-2053,28	59,60934	-5,91353	212,7323
27.9.2013	7:27:36	7,46	9,450815	50,83333	5,432583	1,372684	0,303707	109,1667	-4,88469	-2,21632	305,402	331,6547	-26,2527	93,41058	86,77263	23570,33	-2053,32	63,39626	-6,87076	248,8765
27.9.2013	7:42:41	7,71	9,937313	53,4375	4,311344	1,443287	0,385185	108,5417	-5,24783	-2,28912	245,7622	365,635	-119,873	97,02467	82,22775	24783,66	-4853,32	65,96603	-13,2964	193,0925
27.9.2013	7:57:46	7,96	10,18056	54,27083	4,266495	1,407986	0,466667	107,0833	-6,33724	-2,61673	244,1536	453,6006	-209,447	101,3184	80,81408	25390,32	-2426,64	59,60051	-6,69998	191,2531
27.9.2013	8:12:51	8,21	9,563084	58,95834	5,746529	1,513889	0,466667	107,2917	-5,82885	-2,98073	361,5464	347,9153	13,6311	78,98569	86,00649	23850,33	6159,96	72,03287	22,32594	267,1876
27.9.2013	8:27:57	8,47	10,27412	46,66666	3,817997	1,478588	0,58889	108,9583	-4,81207	-2,14352	174,0668	335,5477	-161,481	96,48296	65,2897	25623,64	-7093,24	48,4391	-18,2345	143,8622

Time String	Time String	debljina leda na cijevima r _i [mm]	protok vode [m ³ /h]	temperat			protok glikola [m ³ /h]	temperat		Φ _{in} =Φ _{vo} de [kW]	Φ _{out} =Φ _{glikola} [kW]	Φ _{glikola} [kW]	kiAi [kW/K]	αAice [kW/K]	masa leda u silosu [kg]	vremenska promjena mase leda u silosu ΔM _w /Δt [kg/h]	Φ _{w,θ}	Φ _{w,M}	Φ _{w,ice}	
				temperat od potrošača M6TT [°C]	ura vode na ulazu u silos M14TT [°C]	temperat na izlazu iz silosa M7TT [°C]		temperat na ulazu u silos M9TT [°C]	temperat na izlazu iz silosa M10TT [°C]											
27.9.2013	17:31:08	17,52	14,07254	54,0625	4,445892	1,513889	0,507412	141,25	-4,6305	-5,52876	246,8371	-138,604	385,4409	-27,2862	84,92255	35096,91	-9333,32	63,48144	-26,9679	210,3236
27.9.2013	17:46:14	17,77	13,1931	49,58333	5,791378	1,478588	0,507412	138,75	-6,2283	-2,90793	306,9	524,5276	-217,628	114,8237	69,3735	32903,59	8773,28	56,17983	32,23561	218,4846
27.9.2013	18:01:19	18,02	14,20352	38,75	4,266495	1,443287	0,507412	138,125	-6,08304	-3,45393	170,6297	413,4564	-242,827	86,70597	65,51896	35423,57	-10079,92	42,30935	-28,0704	156,3907
27.9.2013	18:16:24	18,27	14,63388	39,89583	2,696758	1,302082	0,466667	140,625	-4,84838	-2,50752	102,3159	374,7888	-272,473	101,9015	45,11182	36496,89	-4293,28	38,88449	-7,92252	71,35393
27.9.2013	18:31:29	18,52	14,54032	38,64583	3,369503	1,302082	0,466667	141,0417	-5,32046	-4,69155	128,3329	100,9909	27,342	20,17396	46,18047	36263,55	933,36	37,66618	2,088641	88,57808
27.9.2013	18:46:35	18,78	14,52161	39,58333	3,145256	1,23148	0,385185	138,75	-6,01042	-3,16273	127,9775	449,8567	-321,879	98,08119	50,35922	36263,55	0	39,08236	0	88,89514
27.9.2013	19:01:40	19,03	14,55903	40,20833	3,190105	1,196182	0,385185	139,1667	-5,90147	-3,19913	134,0293	433,9324	-299,903	95,36342	53,91171	36310,22	-186,68	38,04363	-0,38934	96,37501
27.9.2013	19:16:45	19,28	15,13908	31,97916	4,490742	1,160881	0,344448	108,125	-6,44618	-3,38113	153,6402	377,3222	-223,682	76,79049	57,70249	37756,88	-5786,64	30,46031	-16,3214	139,5013
27.9.2013	19:31:51	19,53	15,73785	42,39583	3,683449	1,443287	0,344448	109,5833	-7,17246	-5,52876	165,8215	196,0036	-30,1821	30,86375	62,31828	39250,2	-5973,28	54,35055	-14,0349	125,5058
27.9.2013	19:46:56	19,78	16,29919	45,20833	2,382813	1,12558	0,385185	107,7083	-5,28415	-2,98073	105,7874	286,922	-181,135	69,43168	54,75344	40650,18	-5599,92	39,05068	-9,042	75,77872
27.9.2013	20:02:01	20,03	16,29919	61,97916	2,427662	1,12558	0,344448	108,3333	-5,13889	-2,79873	151,2449	288,6406	-137,396	72,7273	68,58594	40696,85	-186,68	56,48288	-0,30187	95,06389
27.9.2013	20:17:06	20,29	16,65471	37,60416	3,190105	1,12558	0,344448	108,5417	-5,02995	-2,76233	125,3486	280,2312	-154,883	71,9254	55,4564	41536,84	-3359,96	34,26944	-6,92764	98,0068
27.9.2013	20:32:12	20,54	16,84182	47,70833	6,508968	1,23148	0,385185	111,4583	-6,19199	-3,85434	342,2277	292,0388	50,1889	58,13843	87,79324	42003,5	-1866,64	47,10453	-7,50686	302,63
27.9.2013	20:47:17	20,79	17,01023	64,0625	4,042244	1,372684	0,385185	106,4583	-6,19199	-3,38113	274,4333	340,6956	-66,2623	71,17755	92,58964	42423,51	-1680,04	73,80525	-4,33898	204,967
27.9.2013	21:02:22	21,04	17,23476	56,35417	3,055557	1,054977	0,344448	105,8333	-6,55512	-3,59954	178,9675	356,1352	-177,168	70,14223	80,40887	42983,5	-2239,96	46,71481	-4,44259	136,6953
27.9.2013	21:17:27	21,29	17,4593	56,35417	2,158566	1,054977	0,344448	105,4167	-6,70038	-3,74514	122,4441	354,6914	-232,247	67,91269	63,12376	43543,49	-2239,96	46,71481	-3,27055	78,99984
27.9.2013	21:32:33	21,54	17,72126	26,77083	2,158566	0,949074	0,303707	109,1667	-8,40712	-4,54595	58,16661	479,9079	-421,741	74,09951	33,92287	44196,82	-2613,32	20,1565	-3,75358	41,76369
27.9.2013	21:47:38	21,79	18,02064	55,10416	2,024017	0,949074	0,262962	73,33334	-5,53834	-3,23553	110,7783	195,3005	-84,5222	44,51867	61,7879	44943,48	-2986,64	44,10886	-3,98439	70,65383
27.9.2013	22:02:43	22,05	18,07678	27,39583	2,293114	1,019676	0,262962	73,95833	-5,06626	-2,87153	65,14994	184,8067	-119,657	46,56377	32,70559	45083,48	-560	24,18593	-0,83498	41,79899
27.9.2013	22:17:49	22,30	18,09549	26,5625	1,351273	0,949074	0,344448	73,75	-4,99363	-2,83513	32,59502	181,2444	-148,649	46,30221	16,56237	45130,15	-186,68	18,7371	-0,18466	14,04258
27.9.2013	22:32:54	22,55	18,24518	27,08333	1,57552	0,913773	0,222221	75	-6,37355	-3,19913	42,93354	271,066	-228,132	56,63322	25,19658	45503,48	-1493,32	21,85109	-1,56602	22,64846
27.9.2013	22:47:59	22,80	18,451	26,5625	1,485821	0,878471	0,222221	36,25	-6,95457	-3,30833	39,00855	150,4881	-111,48	29,32662	24,25869	46016,8	-2053,28	20,33691	-2,0458	20,71744
27.9.2013	23:03:04	23,05	18,56327	26,66667	1,440971	0,84317	0,222221	36,25	-6,33724	-3,34473	38,07014	123,507	-85,4369	25,51278	23,85575	46296,8	-1120	19,31841	-1,08662	19,83835
27.9.2013	23:18:10	23,30	18,61941	54,27083	2,696758	1,12558	0,222221	36,45833	-6,04673	-3,45393	157,3119	104,607	52,7049	22,02099	69,24919	46436,81	-560,04	57,19702	-0,9536	101,0685
27.9.2013	23:33:15	23,55	18,58199	54,16666	1,79977	1,019676	0,385185	0	-6,08304	-4,98275	92,60146	0	92,60146	0	47,62505	46343,47	373,36	40,09629	0,475869	52,0293
27.9.2013	23:48:20	23,81	18,54456	26,14583	1,934319	0,984375	0,262962	0	-5,9741	-4,61875	49,94064	0	49,94064	0	24,99138	46250,14	373,32	22,00559	0,478502	27,45655

TABLICA 2. PODACI za proces topljenja leda 25.9.2013.

Time String	Time String	debljina leda na cijevima r_i [mm]	protok vode [m ³ /h]	temparat			protok glikola [m ³ /h]	temparat		$\Phi_{in}=\Phi_{vo}$ de [kW]	$\Phi_{out}=\Phi_{gl}$ ikola [kW]	$\Phi_{glikola}$ [kW]	α_{Ai} [kW/K]	α_{Aice} [kW/K]	masa leda u silosu [kg]	vremenska promjena mase leda u silosu $\Delta M_w/\Delta t$ [kg/h]	$\Phi_{w,\theta}$	$\Phi_{w,M}$	$\Phi_{w,ice}$	
				temparat od potrošača M6TT [°C]	ura vode na ulazu u silos M14TT [°C]	temparat na izlazu iz silosa M7TT [°C]		temparat na ulazu u silos M9TT [°C]	temparat na ulazu u iz silosa M10TT [°C]											
25.9.2013	0:07:01	0,12	17,08507	25,3125	1,440971	0,949074	0,222221	72,5	-5,1752	-3,19913	36,13689	166,111	129,9741	39,67146	18,91983	42610,16	-1493,28	14,52634	-1,44877	15,73366
25.9.2013	0:22:07	0,37	17,08507	27,60417	1,440971	0,949074	0,222221	72,70834	-5,68359	-3,45393	39,40854	187,5805	148,172	41,05717	19,24054	42610,16	0	15,84148	0	16,00036
25.9.2013	0:37:12	0,62	16,41146	27,5	1,440971	0,949074	0,222221	72,5	-5,86516	-3,45393	39,25983	199,0331	159,7733	42,71511	13,42303	40930,18	6719,92	15,7817	6,519637	11,16254
25.9.2013	0:52:17	0,87	17,04765	27,39583	1,485821	0,984375	0,222221	36,25	-5,53834	-3,59954	39,24296	83,01958	43,77662	18,17043	22,90489	42516,84	-6346,64	16,02712	-6,32353	19,56126
25.9.2013	1:07:23	1,12	17,60899	28,125	1,440971	0,949074	0,222221	36,45833	-5,86516	-3,59954	40,1521	94,04458	53,89248	19,8727	24,39098	43916,82	-5599,92	16,14038	-5,43302	20,28345
25.9.2013	1:22:28	1,37	16,69213	58,125	6,598667	1,160881	0,222221	36,875	-6,30093	-1,85231	434,1529	186,7693	-247,384	45,81474	98,66121	41630,18	9146,56	368,7499	36,3928	336,4786
25.9.2013	1:37:33	1,63	17,08507	42,1875	2,831306	1,160881	0,303707	0	-6,19199	-4,18194	124,9088	0	-124,909	0	56,45873	42610,16	-3919,92	82,21623	-7,16858	88,49943
25.9.2013	1:52:38	1,88	16,74827	43,125	2,024017	1,266781	0,385185	0	-6,11936	-3,41753	85,0531	0	-85,0531	0	31,11883	41770,18	3359,92	38,09844	4,721924	37,48578
25.9.2013	2:07:44	2,13	16,44888	43,75	2,113716	1,196182	0,385185	0	-6,01042	-3,01713	89,80072	0	-89,8007	0	36,48233	41070,19	2799,96	46,83246	4,08148	45,58287
25.9.2013	2:22:49	2,38	16,28048	122,1875	3,728298	1,655094	0,385185	0	-5,90147	-2,43472	478,4966	0	-478,497	0	142,861	40603,52	1866,68	295,5395	4,479158	293,8282
25.9.2013	2:37:54	2,63	16,20564	100,7292	3,279804	1,407986	0,588889	0	-5,82885	-2,03432	312,7019	0	-312,702	0	111,2891	40416,85	746,68	219,9712	1,685061	215,2718
25.9.2013	2:53:00	2,88	16,4676	106,5625	2,876156	1,619793	0,507412	0	-5,71991	-1,96152	295,6811	0	-295,681	0	95,16446	41070,19	-2613,36	156,1947	-5,15811	160,9977
25.9.2013	3:08:05	3,13	15,70043	53,95833	3,234955	1,337383	0,548149	0	-5,64728	-1,77951	169,8228	0	-169,823	0	57,17232	39156,87	7653,28	119,4548	16,88934	108,1444
25.9.2013	3:23:10	3,39	16,44888	56,97916	2,696758	1,372684	0,507412	0	-5,50203	-1,63391	143,4084	0	-143,408	0	59,56275	41023,52	-7466,6	88,01873	-13,9558	95,42458
25.9.2013	3:38:15	3,64	15,4946	53,75	3,100407	1,337383	0,507412	0	-5,35677	-1,48831	163,5194	0	-163,519	0	53,81293	38643,54	9519,92	110,5563	20,03525	97,07366
25.9.2013	3:53:21	3,89	16,11208	58,22916	2,427662	1,337383	0,466667	0	-5,24783	-1,30631	133,7575	0	-133,758	0	56,42253	40183,52	-6159,92	74,06704	-10,4002	81,65269
25.9.2013	4:08:26	4,14	14,98939	56,97916	3,504051	1,372684	0,507412	0	-5,13889	-1,19711	200,01	0	-200,01	0	61,28069	37383,55	11199,88	141,6841	26,20794	122,9126
25.9.2013	4:23:31	4,39	15,13908	60,83333	3,907696	1,407986	0,507412	0	-5,02995	-1,1243	242,3025	0	-242,303	0	82,14919	37756,88	-1493,32	177,41	-3,84602	181,3488
25.9.2013	4:38:36	4,64	15,12037	58,95834	3,952545	1,443287	0,548149	0	-4,92101	-0,9787	232,0208	0	-232,021	0	75,57868	37710,21	186,68	172,5986	0,490111	170,0783
25.9.2013	4:53:42	4,90	14,6713	57,08333	3,817997	1,443287	0,588889	0	-4,81207	-0,9423	215,92	0	-215,92	0	68,33889	36590,22	4479,96	158,1491	11,51656	150,5809
25.9.2013	5:08:47	5,15	14,80228	60,3125	3,997395	1,443287	0,548149	0	-4,70313	-0,8331	243,6871	0	-243,687	0	80,66367	36916,88	-1306,64	179,7187	-3,46464	183,3301
25.9.2013	5:23:52	5,40	14,57774	59,89583	3,862846	1,478588	0,629631	0	-4,59419	-0,7603	229,7051	0	-229,705	0	73,97105	36356,89	2239,96	166,6083	5,870065	166,1566
25.9.2013	5:38:58	5,65	14,54032	60,9375	3,773148	1,443287	0,588889	0	-4,48525	-0,6875	227,2971	0	-227,297	0	76,04762	36263,55	373,36	165,6386	0,950023	165,8613
25.9.2013	5:54:03	5,90	14,6713	56,77083	3,234955	1,513889	0,629631	0	-4,41262	-0,6511	173,2559	0	-173,256	0	60,38164	36590,22	-1306,68	113,9907	-2,9457	116,675
25.9.2013	6:09:08	6,15	15,04553	62,39583	2,965855	1,549191	0,670368	0	-4,26736	-0,5419	171,0549	0	-171,055	0	61,64631	37523,54	-3733,28	103,1262	-7,91877	112,0799
25.9.2013	6:24:13	6,40	14,80228	48,85416	2,607059	1,478588	0,670368	0	-4,19473	-0,39629	110,8315	0	-110,832	0	37,8494	36916,88	2426,64	64,31892	4,639329	62,02432
25.9.2013	6:39:19	6,66	14,3345	57,5	2,786457	1,443287	0,670368	0	-4,08579	-0,28709	145,5497	0	-145,55	0	50,87868	35750,23	4666,6	90,10432	9,410112	87,93935
25.9.2013	6:54:24	6,91	14,46548	53,02083	2,158566	1,443287	0,588889	0	-3,97685	-0,25069	94,95908	0	-94,9591	0	31,52336	36076,89	-1306,64	44,24547	-2,09413	43,30453
25.9.2013	7:09:29	7,16	14,61517	58,64584	2,158566	1,372684	0,629631	0	-3,8316	-0,21429	105,7796	0	-105,78	0	40,36422	36450,23	-1493,36	53,77016	-2,42887	56,2717
25.9.2013	7:24:34	7,41	13,26794	61,5625	2,158566	1,407986	0,548149	0	-3,79528	-0,17789	119,3672	0	-119,367	0	33,24001	33090,25	13439,92	53,90884	21,22052	44,98561
25.9.2013	7:39:40	7,66	13,45506	60,83333	2,696758	1,407986	0,629631	0	-3,68634	-0,10509	147,3024	0	-147,302	0	56,70513	33556,91	-1866,64	91,46701	-3,62202	94,31166
25.9.2013	7:54:45	7,91	14,25965	85,10416	4,580441	1,725693	0,629631	0	-3,61372	-6,87E-02	393,8565	0	-393,857	0	116,5162	35563,57	-8026,64	283,4428	-24,3946	303,529
25.9.2013	8:09:50	8,16	12,85629	57,70833	6,015625	1,725693	0,874073	0	-3,50478	-0,10509	350,3173	0	-350,317	0	72,86	32063,59	13999,92	288,8256	56,26555	250,9917
25.9.2013	8:24:56	8,42	13,32408	67,91666	3,504051	1,584492	0,833332	0	-3,39583	0,258911	212,4739	0	-212,474	0	73,88103	33230,25	-4666,64	152,0984	-11,8073	160,2252

Time String	Time String	debljina leda na cijevima r_f [mm]	protok vode [m ³ /h]	temperat			protok glikola [m ³ /h]	temperat		$\Phi_{in}=\Phi_{vo}$ de [kW]	$\Phi_{out}=\Phi_{gl}$ ikola [kW]	$\Phi_{uk}=\Phi_{vo}$ de [kW]- $\Phi_{glikola}$ [kW]	α_{AI} [kW/K]	α_{Aice} [kW/K]	masa leda u silosu [kg]	vremenska promjena mase leda u silosu $\Delta M_w/\Delta t$ [kg/h]	$\Phi_{w,\theta}$	$\Phi_{w,M}$	$\Phi_{w,ice}$	
				temperat od potrošača M6TT [°C]	ura vode na ulazu u silos M14TT [°C]	temperat na izlazu na silosa M7TT [°C]		temperat ura glikola na ulazu u silos M9TT [°C]	temperat ura glikola iz silosa M10TT [°C]											
25.9.2013	8:40:01	8,67	13,60475	113,9583	3,817997	1,619793	0,751854	0	-3,32321	0,295315	409,298	0	-409,298	0	130,8193	33930,25	-2800	292,2542	-7,46409	298,9124
25.9.2013	8:55:06	8,92	12,38851	65,52083	3,638599	1,549191	0,874073	0	-3,25058	0,331715	212,1785	0	-212,179	0	62,22621	30803,61	12506,56	159,7164	32,92217	140,4032
25.9.2013	9:10:11	9,17	12,08912	62,39583	4,087093	1,549191	0,792595	0	-3,14164	0,368115	240,7942	0	-240,794	0	74,06024	30150,28	2613,32	184,7469	7,438775	180,6954
25.9.2013	9:25:17	9,42	12,78145	61,14583	2,696758	1,478588	0,751854	0	-3,06901	0,404514	142,2229	0	-142,223	0	56,95958	31876,93	-6906,6	86,90035	-13,8939	98,21574
25.9.2013	9:40:22	9,67	11,67747	60,72916	3,773148	1,513889	0,711113	0	-2,96007	0,440914	217,8254	0	-217,825	0	63,00992	29123,62	11013,24	160,0701	28,80864	141,2765
25.9.2013	9:55:27	9,92	12,35108	58,125	2,696758	1,549191	0,751854	0	-2,88744	0,477318	135,4763	0	-135,476	0	51,63287	30803,61	-6719,96	77,81939	-13,5185	89,03086
25.9.2013	10:10:33	10,18	12,20139	59,79167	2,651909	1,549191	0,792595	0	-2,74219	0,513718	133,3663	0	-133,366	0	45,85207	30430,28	1493,32	76,92224	3,000519	78,96881
25.9.2013	10:25:38	10,43	11,62134	56,45833	3,773148	1,584492	0,751854	0	-2,66956	0,550118	200,0839	0	-200,084	0	59,68667	28983,62	5786,64	144,1625	15,27432	135,0412
25.9.2013	10:40:43	10,68	11,35938	51,77083	2,158566	1,513889	0,792595	0	-2,59693	0,586517	85,3083	0	-85,3083	0	26,87776	28330,29	2613,32	38,93804	4,498858	39,6603
25.9.2013	10:55:48	10,93	11,13484	61,97916	3,234955	1,619793	0,792595	0	-2,48799	0,586517	180,5756	0	-180,576	0	58,38307	27770,29	2240	116,7908	5,262665	117,5704
25.9.2013	11:10:54	11,18	11,8833	59,58333	3,055557	1,655094	0,833332	0	-2,41536	0,695721	155,1008	0	-155,101	0	55,3659	29636,95	-7466,64	97,35162	-16,9382	107,6559
25.9.2013	11:25:59	11,43	11,52778	56,45833	3,952545	1,655094	0,833332	0	-2,30642	0,76852	206,2881	0	-206,288	0	60,8904	28750,29	3546,64	151,3286	9,901374	145,707
25.9.2013	11:41:04	11,68	11,13484	58,33333	3,728298	1,584492	0,833332	0	-2,2338	0,76852	197,816	0	-197,816	0	61,4147	27770,29	3920	145,8979	10,43093	140,0756
25.9.2013	11:56:09	11,94	10,91031	55,625	3,728298	1,619793	0,792595	0	-2,16117	0,841324	194,2084	0	-194,208	0	60,47073	27210,31	2239,92	136,8332	5,907089	136,6908
25.9.2013	12:11:17	12,19	10,66706	59,0625	3,414352	1,655094	0,833332	0	-2,05223	0,87772	181,3867	0	-181,387	0	57,02334	26603,64	2426,68	121,2239	6,012866	121,1086
25.9.2013	12:26:25	12,44	10,34896	57,29166	3,324654	1,655094	0,833332	0	-1,9796	0,87772	167,1946	0	-167,195	0	51,78282	25810,31	3173,32	111,5938	7,696862	107,6561
25.9.2013	12:41:33	12,69	10,31154	56,97916	2,607059	1,619793	0,833332	0	-1,87066	0,95052	121,3805	0	-121,381	0	39,94529	25716,98	373,32	65,62919	0,749214	68,71371
25.9.2013	12:56:41	12,94	10,83546	57,5	2,607059	1,619793	0,874073	0	-1,79803	0,986919	119,4692	0	-119,469	0	42,93286	27023,64	-5226,64	66,22909	-10,6135	74,72747
25.9.2013	13:11:51	13,20	10,94773	59,27083	3,548901	1,655094	0,874073	0	-1,68909	1,023323	185,4259	0	-185,426	0	60,21574	27303,63	-1119,96	130,9554	-2,88957	133,1663
25.9.2013	13:26:59	13,45	9,862466	62,08333	3,683449	1,655094	0,874073	0	-1,61646	1,096123	204,3083	0	-204,308	0	57,04676	24596,99	10826,56	146,9149	28,783	129,9959
25.9.2013	13:42:07	13,70	9,619216	61,97916	2,831306	1,690395	0,874073	0	-1,54384	1,059723	139,1404	0	-139,14	0	41,746	23990,32	2426,68	82,49816	5,245199	77,34237
25.9.2013	13:57:15	13,95	10,31154	63,02083	3,459202	1,725693	0,914818	0	-1,47121	1,168922	181,2095	0	-181,21	0	60,28389	25716,98	-6906,64	127,455	-17,6224	131,8415
25.9.2013	14:12:24	14,21	10,23669	60,625	2,741608	1,690395	0,914818	0	-1,39858	1,205326	123,6521	0	-123,652	0	37,19508	25530,32	746,64	74,35142	1,59252	68,00053
25.9.2013	14:27:32	14,46	8,983029	54,79167	2,382813	1,655094	0,955559	0	-1,32595	1,132523	94,21935	0	-94,2194	0	23,41861	22403,68	12506,56	46,51843	24,35507	39,09001
25.9.2013	14:42:40	14,71	9,076588	53,95833	2,382813	1,655094	0,955559	0	-1,25333	1,278126	93,04603	0	-93,046	0	29,82674	22637,01	-933,32	45,81092	-1,81753	49,78637
25.9.2013	14:57:47	14,96	9,806334	48,85416	3,055557	1,619793	0,914818	0	-1,14439	1,314526	122,5086	0	-122,509	0	46,05027	24457	-7279,96	81,83355	-16,8608	91,41842
25.9.2013	15:12:55	15,22	9,151435	48,54166	2,113716	1,655094	0,914818	0	-1,10807	1,350925	68,17076	0	-68,1708	0	14,31609	22823,68	6533,28	25,97265	11,54198	21,67839
25.9.2013	15:28:01	15,47	9,750196	43,4375	2,56221	1,655094	0,914818	0	-0,99913	1,350925	88,17817	0	-88,1782	0	32,64977	24410,33	-6346,6	45,96999	-12,8726	56,76208
25.9.2013	15:43:08	15,72	8,945607	43,95833	2,517361	1,619793	0,874073	0	-0,96282	1,350925	82,51863	0	-82,5186	0	21,36118	22310,34	8399,96	46,03152	16,61795	36,22252
25.9.2013	15:58:15	15,97	9,319836	37,08333	2,517361	1,619793	0,874073	0	-0,85388	1,460129	71,38278	0	-71,3828	0	25,18034	23243,67	-3733,32	38,83228	-7,38576	42,69874
25.9.2013	16:13:21	16,22	9,637928	72,91666	4,670139	1,690395	0,874073	0	-0,78125	1,496529	318,117	0	-318,117	0	92,24026	24036,99	-3173,28	253,4851	-10,2628	255,6998
25.9.2013	16:28:27	16,47	8,702359	47,39583	2,56221	1,655094	0,955559	0	-0,67231	1,532928	89,19959	0	-89,1996	0	23,74884	21703,68	9333,24	50,1591	19,15211	41,77146
25.9.2013	16:43:33	16,73	9,057876	51,04166	1,84462	1,655094	0,955559	0	-0,63599	1,569332	55,83817	0	-55,8382	0	11,44297	22590,34	-3546,64	11,28601	-5,79322	16,02118
25.9.2013	16:58:40	16,98	8,777205	41,77083	3,145256	1,655094	0,955559	0	-0,52705	1,496529	105,1484	0	-105,148	0	32,91139	21890,35	2799,96	72,61952	6,697902	67,48175

Time String	Time String	debljina leda na cijevima r _i [mm]	protok vode [m ³ /h]	temperat			protok glikola [m ³ /h]	temperat		Φ _{in} =Φ _{vo} de [kW]	Φ _{out} =Φ _{gl} ikola [kW]	Φ _{uk} =Φ _{vo} de [kW]- Φ _{glikola} [kW]	kiAi [kW/K]	αAice [kW/K]	masa leda u silosu [kg]	vremenska promjena mase leda u silosu ΔM _w /Δt [kg/h]	Φ _{w,θ}	Φ _{w,M}	Φ _{w,ice}	
				temperat od potrošača M6TT [°C]	ura vode na ulazu u silos M14TT [°C]	temperat na izlazu iz silosa M7TT [°C]		temperat ura glikola na ulazu u silos M9TT [°C]	temperat ura glikola iz silosa M10TT [°C]											
25.9.2013	17:13:49	17,23	8,384267	27,8125	2,024017	1,690395	0,955559	0	-0,49074	1,642132	34,80958	0	-34,8096	0	5,720609	20910,36	3919,96	10,82534	6,813227	8,522493
25.9.2013	17:28:55	17,48	8,290709	77,70833	2,158566	1,655094	0,996296	0	-0,3818	1,678532	105,7975	0	-105,798	0	28,80523	20677,03	933,32	45,64463	1,717622	45,43827
25.9.2013	17:44:01	17,73	8,30942	57,39583	2,337963	1,725693	1,118523	0	-0,30917	1,678532	85,00181	0	-85,0018	0	25,7356	20723,69	-186,64	40,9987	-0,37632	44,47738
25.9.2013	17:59:08	17,99	8,253284	56,66666	2,158566	1,760994	1,077778	0	-0,23655	1,714931	71,74128	0	-71,7413	0	16,20351	20583,69	560	26,28392	1,057206	26,22006
25.9.2013	18:14:13	18,24	8,215861	26,66667	2,382813	1,725693	1,037037	0	-0,16392	1,751335	42,03804	0	-42,038	0	11,88363	20490,36	373,32	20,44374	0,744741	20,32011
25.9.2013	18:29:20	18,49	8,19715	26,66667	1,84462	1,655094	1,037037	0	-9,13E-02	1,824131	26,49912	0	-26,4991	0	4,985142	20443,69	186,68	5,896365	0,313803	7,182734
25.9.2013	18:44:26	18,74	8,141016	54,0625	2,293114	1,725693	0,996296	0	-5,50E-02	1,824131	82,12514	0	-82,1251	0	21,7038	20303,7	559,96	35,7889	1,074464	35,69634
25.9.2013	18:59:32	18,99	8,141016	26,14583	1,351273	1,725693	1,037037	0	0,017651	1,860531	8,250478	0	-8,25048	0	-10,682	20303,7	0	-11,4211	0	-12,7559
25.9.2013	19:14:38	19,24	8,19715	27,60417	2,113716	1,655094	0,996296	0	9,03E-02	1,896931	34,81465	0	-34,8147	0	8,979479	20443,69	-559,96	14,76986	-1,01586	13,96314
25.9.2013	19:29:45	19,50	8,122304	26,45833	1,934319	1,655094	0,955559	0	0,162907	1,896931	29,07213	0	-29,0721	0	4,880865	20257,03	746,64	8,619132	1,258657	7,052552
25.9.2013	19:44:51	19,75	8,084882	27,29167	1,710068	1,655094	0,955559	0	0,235531	1,969734	24,12101	0	-24,121	0	1,26297	20163,7	373,32	1,750388	0,580494	1,683303
25.9.2013	19:59:57	20,00	8,066171	54,79167	5,38773	1,725693	0,955559	0	0,308159	2,006134	289,9608	0	-289,961	0	75,74884	20117,03	186,68	234,0906	0,690763	240,2484
25.9.2013	20:15:03	20,25	8,122304	53,4375	2,472511	1,760994	1,118523	0	0,344475	2,006134	84,7544	0	-84,7544	0	25,14187	20257,03	-560	44,35864	-1,17307	45,14265
25.9.2013	20:30:09	20,50	8,141016	55	2,203415	1,796295	1,15926	0	0,417099	2,078934	67,27114	0	-67,2711	0	15,76628	20303,7	-186,68	26,12353	-0,36618	26,50843
25.9.2013	20:45:15	20,75	8,141016	27,8125	2,068867	1,760994	1,15926	0	0,489727	2,078934	29,63432	0	-29,6343	0	6,263264	20303,7	0	9,989837	0	10,10931
25.9.2013	21:00:23	21,01	8,215861	26,25	1,979168	1,690395	1,077778	0	0,562355	2,115337	26,46395	0	-26,464	0	5,360451	20537,03	-933,32	8,843673	-1,66431	8,193304
25.9.2013	21:15:28	21,26	8,141016	26,45833	1,710068	1,690395	1,077778	0	0,598667	2,188137	19,59656	0	-19,5966	0	0,245369	20303,7	933,32	0,607267	1,517806	0,342025
25.9.2013	21:30:34	21,51	8,178439	26,5625	2,113716	1,690395	1,037037	0	0,671295	2,188137	33,63227	0	-33,6323	0	8,645201	20397,03	-373,32	13,11854	-0,68614	13,61945
25.9.2013	21:45:41	21,76	8,159728	26,875	2,024017	1,655094	1,037037	0	0,743923	2,115337	31,07121	0	-31,0712	0	7,569333	20350,36	186,68	11,56727	0,333339	11,58507
25.9.2013	22:00:47	22,01	9,357259	27,91667	1,934319	1,655094	1,037037	0	0,816551	2,224537	29,34225	0	-29,3423	0	10,40971	23337	-11946,56	9,094204	-20,7069	15,46548
25.9.2013	22:15:53	22,26	9,413393	27,5	2,113716	1,655094	1,037037	0	0,852863	2,29734	35,99567	0	-35,9957	0	10,48515	23477	-560	14,71412	-1,02925	16,51806
25.9.2013	22:31:01	22,52	9,394683	26,66667	2,068867	1,690395	1,037037	0	0,925491	2,33374	32,23131	0	-32,2313	0	7,593458	23430,34	186,64	11,77469	0,33815	11,79228
25.9.2013	22:46:07	22,77	9,394683	26,35417	1,84462	1,655094	0,996296	0	0,998119	2,37014	24,93087	0	-24,9309	0	3,291272	23430,34	0	5,827267	0	4,675113
25.9.2013	23:01:12	23,02	9,357259	27,08333	1,889469	1,655094	0,996296	0	1,034431	2,37014	28,33602	0	-28,336	0	5,076855	23337	373,36	7,405598	0,6285	7,325305
25.9.2013	23:16:17	23,27	9,394683	26,5625	2,068867	1,655094	1,037037	0	1,070747	2,40654	32,1054	0	-32,1054	0	8,484999	23430,34	-373,36	12,82265	-0,67645	13,1768
25.9.2013	23:31:23	23,52	9,413393	26,66667	1,79977	1,619793	1,037037	0	1,107059	2,44294	23,82553	0	-23,8255	0	4,073864	23477	-186,64	5,599285	-0,30885	5,778382
25.9.2013	23:46:28	23,77	9,338548	26,5625	1,979168	1,584492	0,996296	0	1,252316	2,44294	29,31443	0	-29,3144	0	7,164192	23290,34	746,64	12,23084	1,295934	10,6584

TABLICA 3. PODACI za proces akumulacije/topljenja leda 17.9.2013.

Time	Time String	debljina leda na cijevima r _i [mm]	protok vode [m ³ /h]	temperatur a vode od potrošača M6TT [°C]	temperatura vode na ulazu u silos M14TT [°C]	temperatura vode na izlazu iz silosa M7TT [°C]	protok glikola [m ³ /h]	temperatura glikola na ulazu u silos M9TT [°C]	temperatura glikola iz silosa M10TT [°C]	Φ _{in} =Φ _{vode} [kW]	Φ _{out} =Φ _{glikola} [kW]	Φ _{uk} =Φ _{vode} de [kW]- Φ _{glikola} [kW]	κ _i A _i [kW/K]	α _{Aice} [kW/K]	masa leda u silosu [kg]	vremenska promjena mase leda u silosu ΔM _w /Δt [kg/h]	Φ _{w,φ}	Φ _{w,M}	Φ _{w,ice}	
17.9.2013	0:01:14	0,02	14,20352	27,29167	1,53067	0,984375	0,3037071	73,75	-4,921005	-2,616726	39,22497	193,4845	-154,26	51,3376	20,6615	35423,57	-1306,64	21,67265766	-1,39817	18,95049
17.9.2013	0:16:19	0,27	14,46548	27,5	1,53067	0,9137726	0,2222214	73,125	-5,756222	-2,980728	39,39218	228,0456	-188,653	52,20256	22,67915	36076,89	-2613,28	22,18726767	-2,67213	19,87704
17.9.2013	0:31:25	0,52	14,57774	27,8125	1,440971	0,9137726	0,2222214	72,29166	-6,010418	-3,271931	39,70596	225,3969	-185,691	48,56463	22,06983	36356,89	-1120	22,43939571	-1,08662	18,35318
17.9.2013	0:46:30	0,78	14,78357	26,97917	1,440971	0,9137726	0,2629623	72,08333	-6,15567	-3,417534	38,51628	227,7058	-189,19	47,57149	23,56014	36870,21	-2053,28	20,48470868	-2,04088	20,07245
17.9.2013	1:01:35	1,03	14,97068	27,08333	1,396122	0,9137726	0,2222214	72,08333	-6,264614	-3,490334	37,24213	227,6849	-190,443	46,6809	21,19852	37336,88	-1866,68	21,85109426	-1,76221	17,15324
17.9.2013	1:16:40	1,28	15,17651	28,54167	1,396122	0,9137726	0,2222214	73,54166	-6,010418	-3,344734	39,24748	223,1984	-183,951	47,71668	22,44046	37850,21	-2053,32	23,02769716	-1,9384	18,15819
17.9.2013	1:31:46	1,53	15,3262	26,875	1,396122	0,9490738	0,1814842	72,5	-5,901474	-3,308331	36,95565	214,0491	-177,093	46,48287	18,08154	38223,54	-1493,32	24,06713225	-1,37426	14,26278
17.9.2013	1:46:51	1,78	15,4946	26,77083	1,396122	0,9137726	0,1814842	72,29166	-6,010418	-3,417534	36,81242	213,4127	-176,6	45,27233	19,63377	38643,54	-1680	22,87129631	-1,54605	15,48718
17.9.2013	2:01:56	2,03	15,70043	26,77083	1,396122	0,9137726	0,2222214	72,29166	-6,083042	-3,453934	36,38269	216,3942	-180,012	45,38004	20,66573	39156,87	-2053,32	21,59896621	-1,9384	16,72213
17.9.2013	2:17:01	2,28	15,92496	26,66667	1,396122	0,9137726	0,2222214	72,91666	-6,04673	-3,162731	36,66917	242,4403	-205,771	52,65027	21,34138	39716,86	-2239,96	21,51492891	-2,1146	17,26884
17.9.2013	2:32:07	2,54	16,07466	26,66667	1,396122	0,9137726	0,2222214	35,625	-6,518806	-3,526737	36,66917	121,36	-84,6908	24,16196	20,4703	40090,19	-1493,32	21,51492891	-1,40974	16,56399
17.9.2013	2:47:12	2,79	16,16821	77,60416	1,261574	0,9137726	0,2222214	36,25	-5,82885	-3,417534	94,48198	99,52016	-5,03818	21,52629	44,04653	40323,52	-933,32	62,61179164	-0,80783	32,67802
17.9.2013	3:02:17	3,04	16,1495	78,33334	2,921005	1,196182	0,2222214	73,125	-5,538338	-1,852314	247,6372	306,8831	-59,2459	83,04629	100,7155	40276,86	186,64	89,00918463	0,342214	158,2858
17.9.2013	3:17:23	3,29	16,07466	77,8125	3,055557	1,23148	0,2629623	72,91666	-6,409866	-2,980728	258,6294	284,6825	-26,0531	60,63141	102,0098	40090,19	746,68	87,92324745	1,445425	169,2607
17.9.2013	3:32:28	3,54	16,11208	77,70833	2,921005	1,23148	0,2222214	73,125	-5,574654	-2,871529	245,6613	228,0818	17,5795	54,00825	98,52723	40183,52	-373,32	91,4991004	-0,6845	154,8467
17.9.2013	3:47:33	3,79	16,18692	27,1875	2,831306	1,12558	0,3037071	73,125	-5,538338	-2,835125	80,4968	225,0583	-144,562	53,75513	35,5938	40370,19	-746,68	26,06878105	-1,3655	55,79352
17.9.2013	4:02:38	4,04	16,35533	25,72917	1,485821	0,984375	0,2222214	72,91666	-5,538338	-2,835125	38,08345	224,4098	-186,326	53,60024	19,76472	40790,19	-1680	22,8778428	-1,67388	16,87949
17.9.2013	4:17:44	4,30	16,56115	27,08333	1,440971	0,8784714	0,2222214	72,91666	-6,409866	-2,507523	38,66499	326,9822	-288,317	73,33586	23,95562	41303,51	-2053,28	20,73567453	-1,99208	19,9214
17.9.2013	4:32:49	4,55	16,82311	27,70833	1,396122	0,9137726	0,2222214	71,66666	-6,809319	-3,526737	38,10157	267,0652	-228,964	51,67642	22,50855	41956,84	-2613,32	22,35535034	-2,46706	18,21328
17.9.2013	4:47:54	4,80	17,01023	27,8125	1,396122	0,9137726	0,2222214	72,70834	-5,538338	-3,344734	38,2448	178,5765	-140,332	40,20602	21,71061	42423,51	-1866,68	22,43939571	-1,76221	17,56761
17.9.2013	5:02:59	5,05	17,15992	26,5625	1,351273	0,8784714	0,2222214	72,08333	-6,591434	-3,162731	37,79347	281,3933	-243,6	57,69706	23,93047	42796,84	-1493,32	20,33691406	-1,37068	18,82723
17.9.2013	5:18:05	5,30	17,32832	27,08333	1,396122	0,9137726	0,2222214	72,29166	-6,228298	-2,580322	35,81928	303,2502	-267,431	68,85306	19,22228	43216,83	-1679,96	21,85109426	-1,58594	15,55412
17.9.2013	5:33:10	5,55	17,49672	26,66667	1,396122	0,9490738	0,2222214	36,45833	-5,792534	-3,017128	37,94168	115,2052	-77,2635	26,15428	20,90343	43636,83	-1680	22,6131886	-1,58598	16,91447
17.9.2013	5:48:15	5,80	17,6277	26,66667	1,351273	0,9490738	0,2222214	36,66667	-5,647282	-3,199131	37,94168	103,7177	-65,776	23,44853	21,00779	43963,49	-1306,64	22,6131886	-1,19933	16,52782
17.9.2013	6:03:21	6,06	17,68384	25,83333	1,396122	0,9490738	0,1814842	36,45833	-5,974102	-3,199131	36,756	116,6946	-79,9386	25,44241	17,92216	44103,49	-560	23,13429468	-0,51535	14,13706
17.9.2013	6:18:26	6,31	17,81482	27,29167	1,396122	0,9490738	0,1814842	37,70833	-2,596931	-3,963543	37,52861	-58,6721	96,20066	-17,8865	18,11707	44430,15	-1306,64	24,44026907	-1,20246	14,2908
17.9.2013	6:33:31	6,56	17,90837	25,52083	1,396122	0,9490738	0,1814842	36,04166	-6,446182	-3,490334	35,09355	121,2931	-86,1996	24,41361	16,60497	44663,49	-933,36	22,85444431	-0,85894	13,09805
17.9.2013	6:48:36	6,81	18,00193	26,35417	1,396122	0,9490738	0,1814842	36,25	-5,901474	-3,308331	36,23946	107,0246	-70,7851	23,24145	17,11156	44896,82	-933,32	23,60071794	-0,85891	13,49765
17.9.2013	7:03:42	7,06	18,07678	27,29167	1,396122	0,9490738	0,1814842	36,45833	-6,119358	-3,344734	37,52861	115,1728	-77,6442	24,3389	17,46374	45083,48	-746,64	24,44026907	-0,68711	13,77545
17.9.2013	7:18:47	7,31	18,07678	27,1875	1,396122	0,9490738	0,2222214	37,5	-2,596931	-3,890739	37,38537	-55,2395	92,62491	-17,0291	17,71011	45083,48	0	23,05484956	0	14,33052
17.9.2013	7:33:52	7,56	18,17033	26,25	1,396122	0,9490738	0,1814842	35,83333	-6,191986	-3,490334	36,09622	110,2213	-74,1251	22,76754	17,04823	45316,81	-933,32	23,5074315	-0,85891	13,4477
17.9.2013	7:48:57	7,82	18,22647	28,125	1,396122	0,9490738	0,1814842	36,45833	-6,15567	-3,417534	38,67452	112,1509	-73,4764	23,43017	17,75264	45456,81	-560	25,18653375	-0,51535	14,00334
17.9.2013	8:04:03	8,07	18,32002	26,77083	1,396122	0,984375	0,2222214	36,25	-5,756222	-3,308331	36,81242	101,0297	-64,2173	22,29116	17,16501	45690,14	-933,32	23,8040652	-0,88109	13,88944
17.9.2013	8:19:08	8,32	18,43229	26,97917	1,396122	0,984375	0,2222214	37,91667	-2,923756	-3,672337	38,38632	-32,316	70,70234	-9,79853	19,09894	45970,14	-1120	23,9893168	-1,05732	15,45432

Time	String	Time String	debljina leda na cijevima r _i [mm]	protok vode [m ³ /h]	temperatur a vode od potrošača M6TT [°C]	temperatura vode na ulazu u silos M14TT [°C]	temperatura vode na izlazu iz silosa M7TT [°C]	protok glikola [m ³ /h]	temperatura glikola na ulazu u silos M9TT [°C]	temperatura glikola iz silosa M10TT [°C]	Φ _{in} =Φ _{vode} [kW]	Φ _{out} =Φ _{glikola} [kW]	Φ _{uk=Φ_{vo}} de [kW]- Φ _{glikola} [kW]	kiAi [kW/K]	αAice [kW/K]	masa leda u silosu [kg]	vremenska promjena mase leda u silosu ΔM _w /Δt [kg/h]	Φ _{w,θ}	Φ _{w,M}	Φ _{w,ice}	
17.9.2013		8:34:13	8,57	18,451	26,04167	1,396122	0,984375	0,2222214	35,83333	-5,974102	-3,672337	35,80974	93,9034	-58,0937	19,46903	16,07379	46063,47	-373,32	23,1557113	-0,35243	13,00646
17.9.2013		8:49:19	8,82	18,58199	27,1875	1,396122	0,9490738	0,1814842	36,25	-6,264614	-3,526737	38,68274	112,998	-74,3153	23,08119	19,48073	46343,47	-1120	24,34698263	-1,0307	15,36646
17.9.2013		9:04:24	9,07	18,61941	26,25	1,396122	0,9490738	0,2222214	36,04166	-6,010418	-3,490334	36,09622	103,4115	-67,3153	21,76912	17,535	46436,81	-373,36	22,25985475	-0,35246	14,18883
17.9.2013		9:19:29	9,32	18,65683	26,25	1,396122	0,9490738	0,2222214	37,5	-2,996384	-3,490334	36,09622	-21,0894	57,18557	-6,50232	17,53496	46530,14	-373,32	22,25985475	-0,35243	14,18879
17.9.2013		9:34:35	9,58	18,69425	27,60417	1,396122	0,9490738	0,1814842	35,83333	-5,82885	-3,708736	39,27557	86,49584	-47,2203	18,13789	18,88812	46623,47	-373,32	24,72011944	-0,34356	14,89901
17.9.2013		9:49:41	9,83	19,53627	27,5	2,024017	1,019676	0,2222214	36,25	-6,15567	-3,635937	59,35387	103,9948	-44,6409	21,24162	39,86695	48723,45	-8399,92	25,58500175	-11,0065	44,77533
17.9.2013		10:04:48	10,08	20,11632	27,60417	1,351273	0,984375	0,2222214	0	-5,719906	-3,708736	36,50811	0	36,50811	0	21,95675	50170,1	-5786,6	24,5450538	-5,31136	17,27441
17.9.2013		10:19:54	10,33	19,2556	26,97917	1,396122	0,9490738	0,2222214	0	-5,683594	-3,526737	37,0989	0	37,0989	0	7,556754	48023,46	8586,56	22,87818688	8,106002	6,114712
17.9.2013		10:35:02	10,58	18,86265	38,85416	2,472511	1,12558	0,1814842	0	-5,610966	-2,980728	104,2723	0	104,2723	0	41,75424	47043,46	3920	42,79572415	6,068802	55,40777
17.9.2013		10:50:11	10,84	19,5924	44,375	4,401043	1,160881	0,2629623	0	-5,538338	-2,398319	215,099	0	215,099	0	80,79724	48863,45	-7279,96	46,48599936	-19,8064	188,4194
17.9.2013		11:05:18	11,09	18,78781	42,91666	2,921005	1,160881	0,2629623	0	-5,429398	-1,997917	133,6254	0	133,6254	0	46,33163	46856,8	8026,6	44,95828348	14,90792	73,7592
17.9.2013		11:20:26	11,34	19,49885	42,8125	4,356194	1,196182	0,2629623	0	-5,393085	-1,743114	203,0267	0	203,0267	0	75,99973	48630,13	-7093,32	46,61237981	-19,113	175,5273
17.9.2013		11:35:34	11,59	18,73168	43,125	2,337963	1,23148	0,2629623	0	-5,284145	-1,415508	107,3453	0	107,3453	0	36,1449	46716,8	7653,32	48,72854678	11,61167	47,00509
17.9.2013		11:50:42	11,85	18,97493	93,95833	3,862846	1,478588	0,2629623	0	-5,211517	-1,160702	395,7703	0	395,7703	0	130,0865	47323,46	-2426,64	133,2545208	-5,84025	268,356
17.9.2013		12:05:52	12,10	19,19946	62,60417	3,279804	1,266781	0,3851852	0	-5,138889	-0,9423027	208,9845	0	208,9845	0	81,51907	47883,46	-2240	64,39016889	-4,78892	149,3833
17.9.2013		12:21:00	12,35	18,67554	57,5	3,369503	1,266781	0,3444481	0	-5,029949	-0,6511002	200,3677	0	200,3677	0	68,48295	46576,8	5226,64	61,87316538	11,32337	127,1712
17.9.2013		12:36:09	12,60	18,451	57,60417	3,862846	1,337383	0,3444481	0	-4,921005	-0,6146965	237,4106	0	237,4106	0	78,9578	46110,14	1866,64	66,73005591	4,58121	166,0993
17.9.2013		12:51:17	12,85	18,451	74,89583	2,831306	1,266781	0,3851852	0	-4,848381	-0,6146965	214,6035	0	214,6035	0	85,10546	46016,8	373,36	77,03249069	0,70053	136,8705
17.9.2013		13:06:26	13,11	17,7961	58,22916	3,234955	1,302082	0,3851852	0	-4,775753	-0,5418968	194,3799	0	194,3799	0	65,3537	44383,48	6533,28	62,28848555	13,79664	118,2948
17.9.2013		13:21:34	13,36	17,49672	58,125	3,190105	1,337383	0,3851852	0	-4,666813	-0,505497	194,0322	0	194,0322	0	68,93565	43636,83	2986,6	64,57091331	6,228811	123,2325
17.9.2013		13:36:44	13,61	17,2909	57,8125	2,876156	1,372684	0,3851852	0	-4,594185	-0,4326935	168,6908	0	168,6908	0	60,20819	43123,5	2053,32	66,60473677	3,906337	98,17973
17.9.2013		13:51:51	13,86	17,19734	63,33333	2,965855	1,337383	0,4259262	0	-4,448929	-0,3962936	191,4546	0	191,4546	0	72,09273	42890,16	933,36	67,34652668	1,846689	122,2614
17.9.2013		14:07:00	14,12	17,1225	57,39583	2,786457	1,372684	0,3851852	0	-4,412617	-0,323494	164,4597	0	164,4597	0	61,13781	42703,5	746,64	66,12469879	1,381377	96,95362
17.9.2013		14:22:08	14,37	16,87925	59,58333	2,786457	1,372684	0,4259262	0	-4,267361	-0,2506905	164,7539	0	164,7539	0	58,76872	42096,84	2426,64	65,81281283	4,547257	94,39383
17.9.2013		14:37:17	14,62	16,65471	59,6875	2,696758	1,372684	0,3851852	0	-4,158421	-0,2142906	161,6189	0	161,6189	0	57,64346	41536,84	2240	68,7648904	4,027072	88,82694
17.9.2013		14:52:25	14,87	16,43017	63,33333	2,696758	1,372684	0,4259262	0	-4,122105	-0,1414948	168,4684	0	168,4684	0	60,48212	40976,85	2239,96	69,95487821	4,080234	94,43329
17.9.2013		15:07:35	15,13	16,3179	56,45833	2,472511	1,372684	0,4259262	0	-3,976852	-0,1050949	135,3502	0	135,3502	0	49,05779	40696,85	1120	62,36109169	1,893646	71,09546
17.9.2013		15:22:42	15,38	16,37404	62,5	2,607059	1,407986	0,4259262	0	-3,867912	-3,23E-02	156,702	0	156,702	0	56,76536	40836,85	-560	71,60852708	-0,99078	86,08425
17.9.2013		15:37:51	15,63	16,11208	112,7083	3,145256	1,513889	0,4666672	0	-3,795284	4,05E-02	353,6415	0	353,6415	0	116,5213	40183,52	2613,32	137,7023536	5,506148	210,433
17.9.2013		15:52:59	15,88	15,79398	112,5	3,773148	1,584492	0,5888901	0	-3,650028	7,69E-02	419,6254	0	419,6254	0	128,783	39390,2	3173,28	130,6727494	8,074481	280,8782
17.9.2013		16:08:08	16,14	16,52373	112,5	3,234955	1,619793	0,629631	0	-3,541088	0,1133118	343,3328	0	343,3328	0	118,9185	41210,18	-7279,92	129,9587625	-16,4114	229,7855
17.9.2013		16:23:16	16,39	16,05594	113,0208	2,876156	1,655094	0,6703682	0	-3,46846	0,1861115	303,3581	0	303,3581	0	92,40605	40043,52	4666,64	129,8435806	9,654372	163,8601
17.9.2013		16:38:24	16,64	15,90625	50	3,504051	1,513889	0,629631	0	-3,35952	0,2225113	165,7264	0	165,7264	0	53,48448	39670,2	1493,28	51,58171667	3,600768	110,5439
17.9.2013		16:53:31	16,89	14,85841	59,27083	2,472511	1,478588	0,5481491	0	-3,25058	0,3317146	133,6069	0	133,6069	0	33,66713	37056,88	10453,28	64,33920018	18,41922	50,84848

Time		debljina leda na cijevima r_i [mm]	protok vode m^3/h	temperatur a vode od potrošača M6TT [°C]	temperatura vode na ulazu u silos M14TT [°C]	temperatura vode na izlazu iz silosa M7TT [°C]	protok glikola m^3/h	temperatura glikola na ulazu u silos M9TT [°C]	temperatura glikola iz silosa M10TT [°C]	$\dot{m}_{in}=\Phi_{vode}$ [kg/h]	$\Phi_{out}=\Phi_{glikola}$ [kW]	$\Phi_{glikola}$ [kW]	$k_i A_i$ [kW/K]	αA_{ice} [kW/K]	masa leda u silosu [kg]	vremenska promjena mase leda u silosu $\Delta M_w/\Delta t$ [kg/h]	$\Phi_{w,\theta}$	$\Phi_{w,M}$	$\Phi_{w,ice}$	
17.9.2013	17:08:40	17,14	14,65259	58,54166	2,607059	1,513889	0,5481491	0	-3,177952	0,4045143	138,3961	0	138,3961	0	43,52055	36543,55	2053,32	65,95868635	3,779214	68,6582
17.9.2013	17:23:50	17,40	14,65259	59,47916	2,786457	1,478588	0,5481491	0	-3,069012	0,4409142	152,8253	0	152,8253	0	52,93576	36543,55	0	64,5653449	0	88,25996
17.9.2013	17:38:58	17,65	14,61517	60,83333	2,517361	1,513889	0,629631	0	-2,996384	0,5137177	137,4218	0	137,4218	0	47,01556	36450,23	373,28	62,75775184	0,685247	73,9788
17.9.2013	17:54:06	17,90	15,41976	63,33333	2,696758	1,443287	0,629631	0	-2,887444	0,5501175	156,3784	0	156,3784	0	67,23985	38456,87	-8026,56	60,12013461	-15,5747	111,833
17.9.2013	18:09:17	18,15	15,02682	58,125	3,728298	1,549191	0,5888901	0	-2,7785	0,5865173	207,9252	0	207,9252	0	61,58311	37476,88	3919,96	65,12040478	9,871869	132,9329
17.9.2013	18:24:24	18,41	15,08295	55,72916	2,337963	1,513889	0,629631	0	-2,705875	0,6593208	111,5208	0	111,5208	0	37,06578	37616,88	-560	57,49211482	-0,96941	54,9981
17.9.2013	18:39:33	18,66	14,55903	54,58333	3,773148	1,478588	0,629631	0	-2,596931	0,7321205	200,9911	0	200,9911	0	60,42824	36263,55	5413,32	54,0620501	13,90296	133,0261
17.9.2013	18:54:41	18,91	14,31578	42,1875	2,517361	1,407986	0,629631	0	-2,487991	0,8049164	93,28777	0	93,28777	0	32,10902	35656,89	2426,64	38,30966016	4,454693	50,52342
17.9.2013	19:09:48	19,16	13,79186	45,72916	2,517361	1,372684	0,5888901	0	-2,379051	0,8413239	103,3017	0	103,3017	0	33,70849	34396,91	5039,92	41,81594277	9,132233	52,35352
17.9.2013	19:24:55	19,42	14,74615	50,41667	2,472511	1,407986	0,5888901	0	-2,306423	0,9141197	110,9994	0	110,9994	0	52,14702	36776,89	-9519,92	48,17876897	-17,0008	79,82147
17.9.2013	19:40:02	19,67	14,05382	44,58333	2,113716	1,372684	0,5888901	0	-2,233795	0,9869194	81,97539	0	81,97539	0	22,43669	35050,23	6906,64	40,76816578	10,88846	30,31877
17.9.2013	19:55:09	19,92	14,65259	44,58333	2,965855	1,302082	0,5481491	0	-2,161167	1,023323	123,921	0	123,921	0	55,17937	36543,55	-5973,28	39,21497916	-12,2442	96,95026
17.9.2013	20:10:15	20,17	13,75444	36,77083	2,651909	1,302082	0,5481491	0	-2,052227	1,096123	91,76041	0	91,76041	0	26,68185	34303,57	8959,92	32,34319491	16,72549	42,69173
17.9.2013	20:25:22	20,42	14,35321	72,39583	4,894386	1,549191	0,5481491	0	-1,943287	1,168922	368,5769	0	368,5769	0	111,342	35796,9	-5973,32	84,54980242	-18,9642	302,9913
17.9.2013	20:40:30	20,68	14,35321	28,22917	1,710068	1,407986	0,6703682	0	-1,834347	1,205326	34,38009	0	34,38009	0	8,475221	35796,9	0	24,29272798	0	10,08736
17.9.2013	20:55:35	20,93	14,05382	29,6875	2,068867	1,407986	0,6703682	0	-1,761719	1,241726	47,21671	0	47,21671	0	12,33675	35050,23	2986,68	25,54769984	4,772378	16,89663
17.9.2013	21:10:41	21,18	13,96027	26,45833	1,754917	1,337383	0,629631	0	-1,652779	1,278126	34,87599	0	34,87599	0	9,839038	34816,9	933,32	21,8469253	1,298235	11,73083
17.9.2013	21:25:47	21,43	13,86671	27,29167	1,57552	1,23148	0,5481491	0	-1,580151	1,314526	34,27796	0	34,27796	0	10,70252	34583,57	933,32	21,75744833	1,156203	11,36431
17.9.2013	21:40:53	21,68	13,90413	56,77083	1,57552	1,23148	0,4666672	0	-1,507523	1,387329	73,73949	0	73,73949	0	23,0426	34676,9	-373,32	50,65556703	-0,44473	23,52865
17.9.2013	21:55:59	21,93	13,82929	49,47916	1,934319	1,23148	0,4259262	0	-1,398582	1,423729	87,42544	0	87,42544	0	33,80692	34490,24	746,64	46,50114625	1,027981	39,89631
17.9.2013	22:11:06	22,19	13,81057	78,54166	2,113716	1,443287	0,5888901	0	-1,325954	1,460129	140,2883	0	140,2883	0	45,66256	34443,57	186,68	78,29004263	0,294305	61,70395
17.9.2013	22:26:12	22,44	13,66088	29,79167	1,710068	1,302082	0,629631	0	-1,253326	1,496529	36,13954	0	36,13954	0	9,17133	34070,24	1493,32	23,37234466	2,03812	10,72908
17.9.2013	22:41:18	22,69	13,58604	26,97917	1,620369	1,266781	0,629631	0	-1,180698	1,532928	31,31038	0	31,31038	0	9,133932	33883,58	746,64	20,05474119	0,979965	10,27567
17.9.2013	22:56:23	22,94	13,49248	27,1875	1,754917	1,23148	0,5481491	0	-1,071758	1,605732	38,43211	0	38,43211	0	13,68139	33696,91	746,68	21,67440198	1,003131	15,75458
17.9.2013	23:11:29	23,19	13,41763	27,5	1,620369	1,160881	0,4666672	0	-1,035446	1,605732	37,16442	0	37,16442	0	13,18182	33463,58	933,32	22,27269275	1,136259	13,75547
17.9.2013	23:26:35	23,44	13,39892	54,0625	1,57552	1,23148	0,4259262	0	-0,926506	1,642132	72,8017	0	72,8017	0	21,75939	33416,91	186,68	50,8086277	0,217951	21,77512
17.9.2013	23:41:41	23,69	13,32408	53,85416	2,024017	1,23148	0,4259262	0	-0,8901901	1,678532	100,8143	0	100,8143	0	40,11066	33230,25	746,64	50,61282711	1,067048	49,13442
17.9.2013	23:56:47	23,95	13,32408	53,02083	1,889469	1,302082	0,5888901	0	-0,78125	1,714931	80,77638	0	80,77638	0	29,5841	33230,25	0	44,11636424	0	36,66002

PRILOG (nacrt silosa)

Pos. no.	Description	Connections
V1	Butterfly valve "LU0" type, valve disk AISI304, seal EPDM	NO250
V2	Butterfly valve "LU0" type, valve disk AISI304, seal EPDM	NO250
V3	Butterfly valve "LU0" type, valve disk AISI304, seal EPDM	NO300
V4	Butterfly valve "LU0" type, valve disk AISI304, seal EPDM	NO300
V5	Butterfly valve "LU0" type, valve disk AISI304, seal EPDM	NO300
V6	Butterfly valve "LU0" type, valve disk AISI304, seal EPDM	NO300
V7	Ball valve	NO15
V8	Butterfly valve "LU0" type, valve disk AISI304, seal EPDM	NO200
V9	Non-return valve	NO200
V10	Butterfly valve "LU0" type, valve disk AISI304, seal EPDM	NO200
V11	Butterfly valve "LU0" type, valve disk AISI304, seal EPDM	NO200
V12	Non-return valve	NO200
V13	Butterfly valve "LU0" type, valve disk AISI304, seal EPDM	NO200
V14	Butterfly valve "LU0" type, valve disk AISI304, seal EPDM	NO200
V15	Butterfly valve "LU0" type, valve disk AISI304, seal EPDM	NO200
V16	Ball valve	NO15
V17	Ball valve	NO15
V18	Butterfly valve "LU0" type, valve disk AISI304, seal EPDM	NO200
V19	Ball valve	NO15
V20	Butterfly valve "LU0" type, valve disk AISI304, seal EPDM	NO200
V21	Butterfly valve "LU0" type, valve disk AISI304, seal EPDM	NO200
V22	Butterfly valve "LU0" type, valve disk AISI304, seal EPDM	NO200
V23	Butterfly valve "LU0" type, valve disk AISI304, seal EPDM	NO200
V24	Butterfly valve "LU0" type, valve disk AISI304, seal EPDM	NO200
V25	Ball valve	NO25
V26	Ball valve	NO25
V27	Strainer	NO25
V28	Strainer	NO25
V29	Ball valve	NO25
V30	Ball valve	NO25
V31	Butterfly valve "LU0" type, valve disk AISI304, seal EPDM	NO200
V32	Ball valve	NO8
V33	Butterfly valve "LU0" type, valve disk AISI304, seal EPDM	NO10
V34	Butterfly valve "LU0" type, valve disk AISI304, seal EPDM	NO8
V35	Ball valve	NO8
V36	Ball valve	NO10
V37	Butterfly valve "LU0" type, valve disk AISI304, seal EPDM	NO8
V38	Ball valve	NO8
V39	Butterfly valve "LU0" type, valve disk AISI304, seal EPDM	NO10
V40	Ball valve	NO8
V41	Butterfly valve "LU0" type, valve disk AISI304, seal EPDM	NO8
V42	Ball valve	NO10
V43	Butterfly valve "LU0" type, valve disk AISI304, seal EPDM	NO8
V44	Ball valve	NO8
V45	Butterfly valve "LU0" type, valve disk AISI304, seal EPDM	NO10
V46	Ball valve	NO8
V47	Butterfly valve "LU0" type, valve disk AISI304, seal EPDM	NO8
V48	Ball valve	NO8
V49	Butterfly valve "LU0" type, valve disk AISI304, seal EPDM	NO8
V50	Ball valve	NO8
V51	Butterfly valve "LU0" type, valve disk AISI304, seal EPDM	NO8
V52	Ball valve	NO8
V53	Butterfly valve "LU0" type, valve disk AISI304, seal EPDM	NO8
V54	Ball valve	NO8
V55	Butterfly valve "LU0" type, valve disk AISI304, seal EPDM	NO8
V56	Ball valve	NO8
V57	Butterfly valve "LU0" type, valve disk AISI304, seal EPDM	NO8
V58	Ball valve	NO8
V59	Butterfly valve "LU0" type, valve disk AISI304, seal EPDM	NO8
V60	Ball valve	NO8
V61	Butterfly valve "LU0" type, valve disk AISI304, seal EPDM	NO200
V62	Ball valve	NO200
V63	Butterfly valve "LU0" type, valve disk AISI304, seal EPDM	NO200
V64	Ball valve	NO200
V65	Butterfly valve "LU0" type, valve disk AISI304, seal EPDM	NO200
V66	Ball valve	NO200
V67	Butterfly valve "LU0" type, valve disk AISI304, seal EPDM	NO200
V68	Ball valve	NO200
V69	Butterfly valve "LU0" type, valve disk AISI304, seal EPDM	NO200
V70	Ball valve	NO15
V71	Ball valve	NO15
V72	Ball valve	NO200
V73	Ball valve	NO200
V74	Ball valve	NO200
V75	Ball valve	NO200
V76	Butterfly valve "LU0" type, valve disk AISI304, seal EPDM	NO200
V77	Butterfly valve "LU0" type, valve disk AISI304, seal EPDM	NO200
V78	Ball valve	NO15
V79	Non-return valve	NO25
V80	Ball valve	NO25

Pos. no.	Description
M1	Pressure transmitter Danfos MBS3000 1811-1 AB04, 0-6 bar, output 4-20mA, connection G1/4
M2	Pressure pump, 0.6 bar, stainless steel, duplex, Ø100mm, connection G1/2
M3	Pressure transmitter Danfos MBS3000 1811-1 AB04, 0-6 bar, output 4-20mA, connection G1/4
M4	Pressure transmitter Danfos MBS3000 1811-1 AB04, 0-6 bar, output 4-20mA, connection G1/4
M5	Flow meter, Siemens Sitrans F M MAGFLD MAG 5100V, N200
M6	Temperature sensor Danfos MTB5252, Pt100, 0-100°C, output 4-20mA, connection G1/2A
M7	Temperature sensor Danfos MTB5252, Pt100, 0-100°C, output 4-20mA, connection G1/2A
M8	Level transmitter Endress+Hauser FMU40-ARB1A2, Ptasonic, M FMU40
M9	Temperature sensor Danfos MTB5252, Pt100, 0-100°C, output 4-20mA, connection G1/2A
M10	Temperature sensor Danfos MTB5252, Pt100, 0-100°C, output 4-20mA, connection G1/2A
M11	Flow meter, Siemens Sitrans F M MAGFLD MAG 5100V, N200
M12	Differential pressure transmitter Regn DTR1000, 0-10 bar, output 0-10 V DC
M13	Differential pressure transmitter Regn DTR1000, 0-10 bar, output 0-10 V DC
M14	Temperature sensor Danfos MTB5252, Pt100, 0-100°C, output 4-20mA, connection G1/2A
M15	Level limit switch Endress+Hauser Lqipant t FTL20-D10
M16	Temperature sensor Danfos MTB5252, Pt100, 0-100°C, output 4-20mA, connection G1/2A
M17	Watermeter Eder context Arist MWA10W
M18	Conductivity cell, type 5592 Hoch-Lange, with Pt1000
M19	Measuring range: 0.5-80000 µS/cm
M20	Connection: R 1/2"

Pos. no.	Description
1	Frequency converter Danfos VLT AQUA Drive FC202, 22 kW
2	Frequency converter Danfos VLT AQUA Drive FC202, 22 kW
3	Deceleration device
4	Deceleration device
5	Frequency converter Danfos VLT AQUA Drive FC202, 5.5 kW
6	Impeller agitator, 5.5 kW, 1000 1/min, 3x400V
7	Centrifugal pump GRUNDFOS TP150-280/4
8	Centrifugal pump GRUNDFOS TP150-280/4
9	Self-regulating heating cable
10	Self-regulating heating cable
11	Self-regulating heating cable
12	Pump, inox
13	Qmax=3.8 m³/hr
14	Pmax=5 bar
15	Nem=1.2 kW, 230V

Pos. no.	Description	Connections
MV1	Butterfly valve, "LU0" type, with actuator, end position switch and tracer in valve body, Valve disk AISI304, seal EPDM	NO200
MV2	Butterfly valve, "LU0" type, with actuator, end position switch and tracer in valve body, Valve disk AISI304, seal EPDM	NO200
MV3	Butterfly valve, "LU0" type, with actuator, end position switch and tracer in valve body, Valve disk AISI304, seal EPDM	NO200
MV4	Butterfly valve, "LU0" type, with actuator, end position switch and tracer in valve body, Valve disk AISI304, seal EPDM	NO200
MV5	Butterfly valve, "LU0" type, with actuator, end position switch and tracer in valve body, Valve disk AISI304, seal EPDM	NO200
MV6	Butterfly valve, "LU0" type, with actuator, end position switch and tracer in valve body, Valve disk AISI304, seal EPDM	NO200
MV7	Butterfly valve, "LU0" type, with actuator, end position switch and tracer in valve body, Valve disk AISI304, seal EPDM	NO200
MV8	Butterfly valve, "LU0" type, with actuator, end position switch and tracer in valve body, Valve disk AISI304, seal EPDM	NO200
MV9	Butterfly valve, "LU0" type, with actuator, end position switch and tracer in valve body, Valve disk AISI304, seal EPDM	NO200
MV10	Butterfly valve, "LU0" type, with actuator, end position switch and tracer in valve body, Valve disk AISI304, seal EPDM	NO200

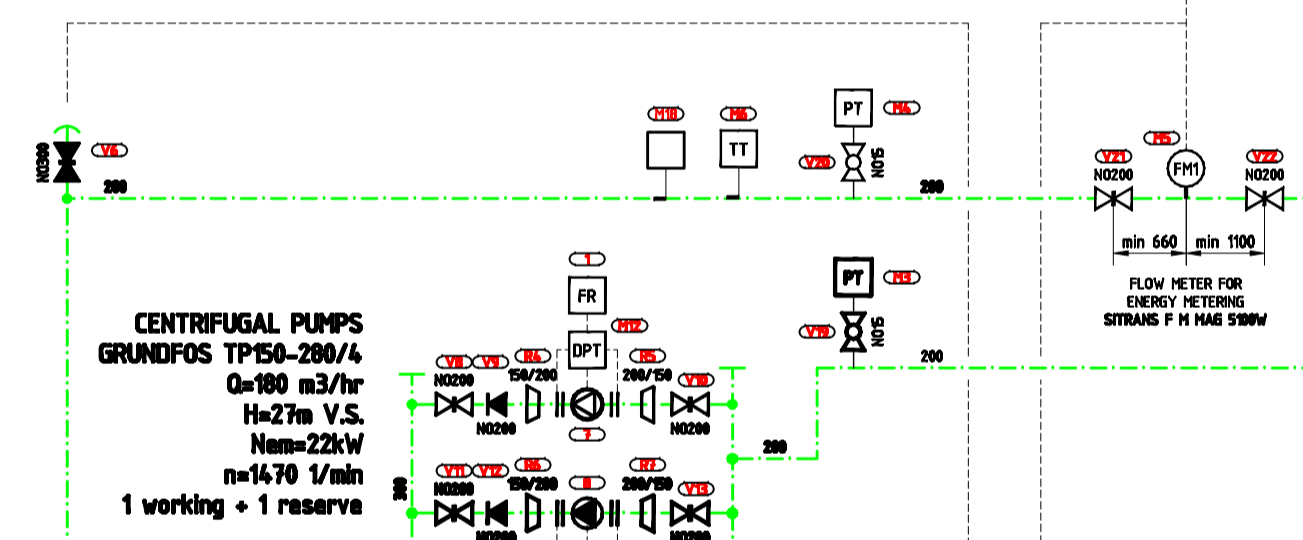
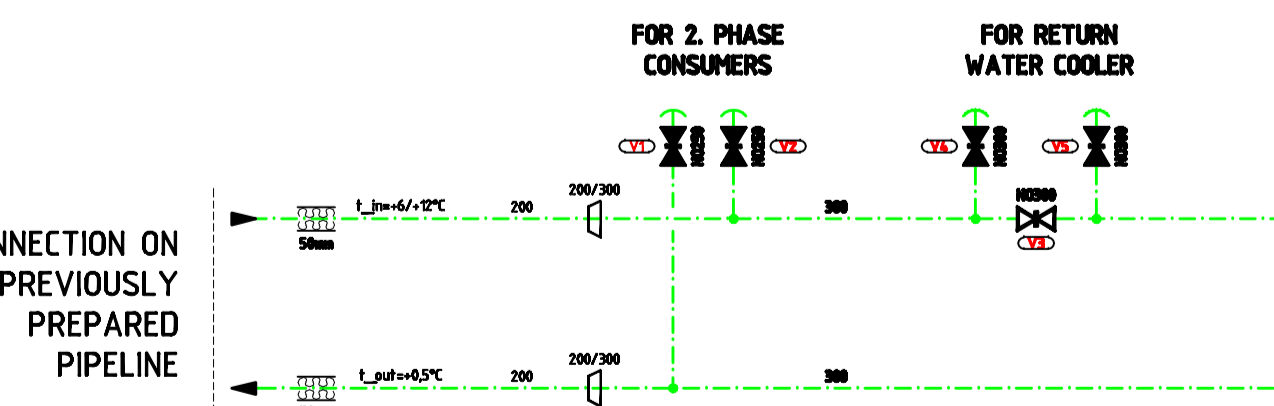

FROM/TO COOLING AGGREGATE FOR PROPYLENE GLYCOL - PROVIDED BY CUSTOMER

ICE BANK SILO IWA3760
Capacity: 5460 kWh
Max. ice thickness: 25mm
Swing time charging time: 10-10h

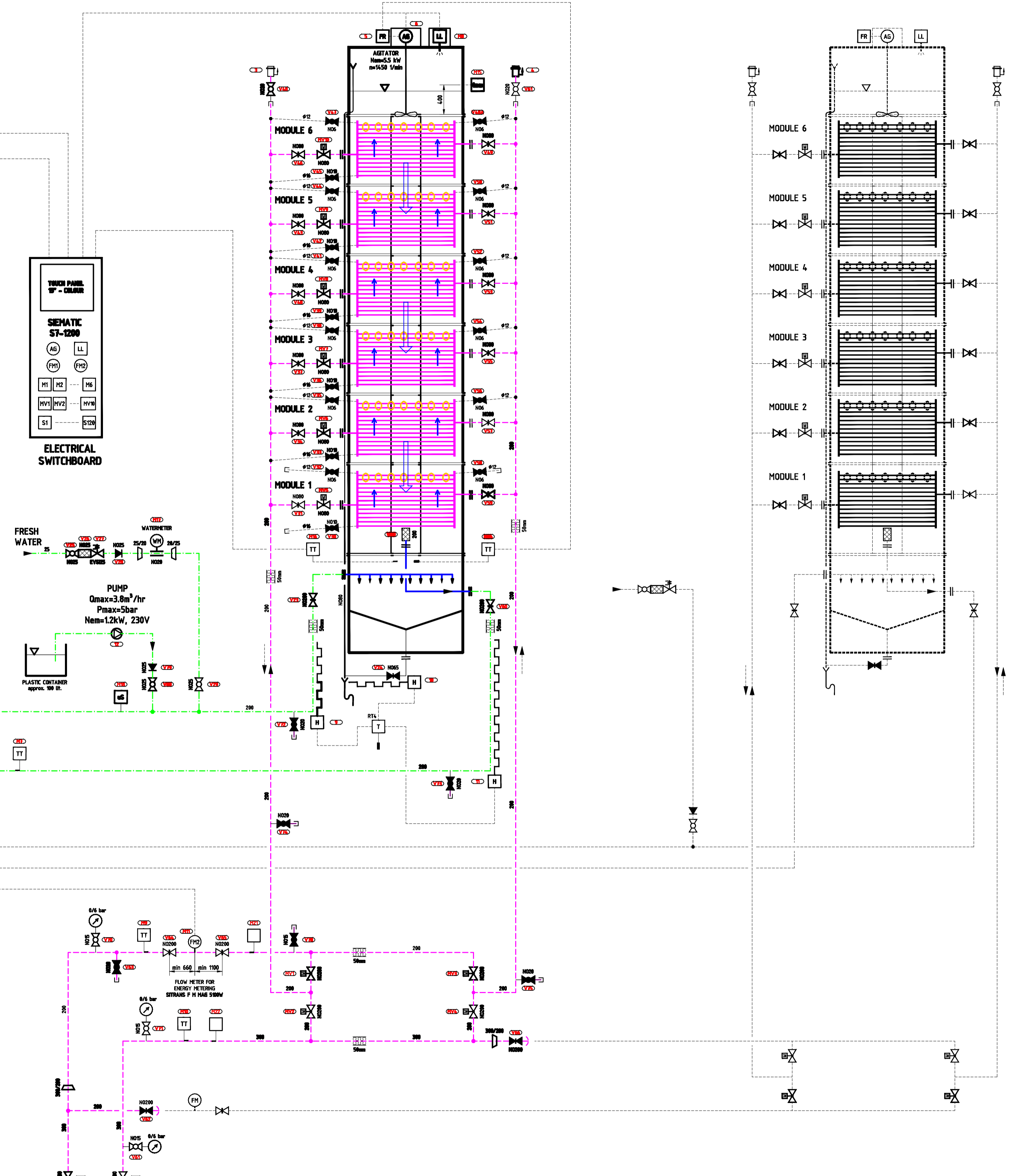

		INŽENJERING • CONSULTING • PROJEKTIranJE • PROJEKCIJA • MONTAŽA I SERVIS RASHLADNIH TOPLJENSKI I TEHNOLOŠKI POSTROJEKCIJA	www.frigoterm.com frigoterm@frigoterm.com
Glavni projektant:	Z. VOJVODA, dipl.ing.	Vrsta projekta:	
Suradnik:	D. SEKIŠAK, dipl.ing.	Investitor:	TNE SA, BYRKJELO DIARY
Crtao:	M. NEŠIĆ, dipl.ing.	Naziv i mjesto:	BYRKJELO, NORWAY
Odobrio:	Z. VOJVODA, dipl.ing.	Mjerilo:	
Datum:	13.11.2012.	Specifikacija:	
Naziv nacrt:	Schematic Diagram - SILO IWA3760		Nacrt broj: 40824-9

REMARK:
ALL RIGHTS ARE RESERVED.
IT IS FORBIDDEN TO USE OR COPY THIS DRAWING WITHOUT
WRITTEN PERMISSION OF COMPANY FRIGOTERM d.o.o.