

# The impact of district heating and cooling on the penetration of intermittent renewable energy sources in moderate and Mediterranean climates

---

**Novosel, Tomislav**

**Doctoral thesis / Disertacija**

**2023**

*Degree Grantor / Ustanova koja je dodijelila akademski / stručni stupanj:* **University of Zagreb, Faculty of Mechanical Engineering and Naval Architecture / Sveučilište u Zagrebu, Fakultet strojarstva i brodogradnje**

*Permanent link / Trajna poveznica:* <https://urn.nsk.hr/urn:nbn:hr:235:013828>

*Rights / Prava:* [In copyright](#) / [Zaštićeno autorskim pravom.](#)

*Download date / Datum preuzimanja:* **2024-09-15**

*Repository / Repozitorij:*

[Repository of Faculty of Mechanical Engineering and Naval Architecture University of Zagreb](#)





Sveučilište u Zagrebu

FACULTY OF MECHANICAL ENGINEERING AND NAVAL  
ARCHITECTURE

TOMISLAV NOVOSEL

**THE IMPACT OF DISTRICT HEATING AND  
COOLING ON THE PENETRATION OF  
INTERMITTENT RENEWABLE ENERGY  
SOURCES IN MODERATE AND  
MEDITERRANEAN CLIMATES**

DOCTORAL THESIS

Zagreb, 2023



Sveučilište u Zagrebu

FAKULTET STROJARSTVA I BRODOGRADNJE

TOMISLAV NOVOSEL

**UTJECAJ SUSTAVA CENTRALIZIRANOGA  
GRIJANJA I HLAĐENJA NA PENETRACIJU  
OBNOVLJIVIH INTERMITENTNIH  
IZVORA ENERGIJE U UMJERENIM I  
MEDITERANSKIM KLIMAMA**

DOKTORSKI RAD

Zagreb, 2023



Sveučilište u Zagrebu

FACULTY OF MECHANICAL ENGINEERING AND NAVAL  
ARCHITECTURE

TOMISLAV NOVOSEL

**THE IMPACT OF DISTRICT HEATING AND  
COOLING ON THE PENETRATION OF  
INTERMITTENT RENEWABLE ENERGY  
SOURCES IN MODERATE AND  
MEDITERRANEAN CLIMATES**

DOCTORAL THESIS

SUPERVISOR:

Prof.dr.sc. NEVEN DUIĆ

Zagreb, 2023



Sveučilište u Zagrebu

FAKULTET STROJARSTVA I BRODOGRADNJE

TOMISLAV NOVOSEL

**UTJECAJ SUSTAVA CENTRALIZIRANOGA  
GRIJANJA I HLAĐENJA NA PENETRACIJU  
OBNOVLJIVIH INTERMITENTNIH  
IZVORA ENERGIJE U UMJERENIM I  
MEDITERANSKIM KLIMAMA**

DOKTORSKI RAD

Mentor:

Prof.dr.sc. Neven Duić

Zagreb, 2023

## **BIBLIOGRAPHY DATA**

UDC: **620**

**621**

*Keywords: district heating, district cooling, energy planning, GIS, power to heat, power to cold*

*Scientific area:* TECHNICAL SCIENCES

*Scientific field:* Mechanical engineering

*Institution:* Faculty of Mechanical Engineering and Naval Architecture

*Thesis supervisor:* Prof. Neven Duić, PhD

*Number of pages:* 197

*Number of figures:* 28

*Number of tables:* 16

*Number of references:* 72

*Date of examination:* 26.06.2023

*Thesis defence commission:*

Asst. prof. Tomislav Pukšec, PhD – Chairman of defence commission

Julije Domac, PhD – member

Prof. Kristina Lygnerud, PhD – external member

*Archive:* Faculty of Mechanical Engineering and Naval Architecture

## **MENTOR**

Prof. dr. sc. (PhD) Neven Duić (6,000+ citations, 40+ H-Index) is a full professor at the Power Engineering and Energy Management Chair at the Department of Energy, Power and Environmental Engineering, Faculty of Mechanical Engineering and Naval Architecture, University of Zagreb, Croatia. He is Chair of the Energy Department of the Croatian Academy of Technical Sciences and president of the International Centre for Sustainable Development of Energy, Water and Environment Systems (SDEWES). He is an editor of the Q1 “Energy Conversion Management” journal, subject editor for the Q1 journal “Energy”, a member of the editorial board of the following journals: Q1 journal “Applied Energy”, Q3 journal “Thermal Science” and since 2013 he is Editor-in-Chief of the Journal of Sustainable Development of Energy, Water and Environment Systems (JSDEWES). He has organised the series of conferences on Sustainable Development of Energy, Water and Environment Systems and was a member of the organising, scientific and programming committees of more than 40 research conferences. He is the coordinator of the Croatian participation in two projects of the Croatian Science Foundation and over 25 international scientific research projects. Prof. Duić has received awards from the University of Zagreb for the improvement of international relations achieved under an international scientific project, the National Award for significant scientific achievement in 2016 in the field of technical sciences, the Great Medal from the Faculty of Mechanical Engineering and Naval Architecture, and the Medal Atanasije Stojković from the Society of Thermal Engineers of Serbia.

## **ACKNOWLEDGEMENT**

Thank you to everyone that has supported me throughout this process! This would not be possible without the support of my family, friends and colleagues. Thank you Mia and thank you mom for always being by my side. I love you all.



## PREFACE

*“Hell, it's about time”*

Tychus Findlay

## SUMMARY

The European Union has set an ambitious goal of a total or at least near-total decarbonisation until 2050. Buildings represent the single largest contributor of greenhouse gases and are the largest single energy consumer across the continent. As more and more people move into densely populated urban areas, the sustainable supply of energy for space heating, cooling and the production of domestic hot water will become an ever-increasing issue. District heating and cooling systems present themselves as an ideal solution in this process as they enable the production and utilization of renewable and waste energy at locations where they are available as well as their distribution to the locations where they are need at high energy densities. They also allow for increased flexibility in terms of production technologies and energy sources as the majority of the system and the associated costs are linked to the distribution side which consists of hot water pipes and systems of distributing the water. Finally, the utilization of district heating and cooling systems in a combination with power to heat and heat storage technologies can lock the potential to increase the overall energy systems flexibility and in turn, increase its capacity to utilize intermittent renewable electricity sources.

The main objective of this doctoral thesis is the assessment and quantification of the impact of district heating and district heating and cooling on the potential for the utilization of intermittent renewables in moderate and Mediterranean climates. The hypothesis of the thesis is that a high share of district heating and district heating and cooling in a combination with power to heat and heat storage can have a significant and positive impact on the potential of the energy system as a whole to integrate more intermittent renewables into its electricity generation without generating excessive critical excess of electricity in Europe's continental and Mediterranean climates. The doctoral thesis is based on six papers, four of which have been published in high impact factor CC journals, one in a Q2 journal and one conference paper.

The presented results have confirmed the proposed hypothesis. As seen in the results of the thesis, systems with a high share of district heating and cooling could easily absorb 4.000 MW of wind and 4.000 MW of PV which would produce upwards of 17,13 TWh of electricity, or roughly 73% of the total electricity demand (including the additional demand from heat generation through heat pumps and electric boilers), with roughly 5% critical excess of electricity production. The results also demonstrate that district cooling, even though it represents a much smaller demand than district heating and is integrated into the scenarios with much smaller shares, still decreases critical excess of electricity production by up to an additional 12% when comparing scenarios with and without cooling.

Demand side management and flexibility of energy systems is an increasingly important element as the share of intermittent renewable energy sources such as wind and solar power increase. District heating and cooling can enable this flexibility while also providing an adaptable and sustainable source of heating and cooling energy for Europe's densely populated cities. It is a key technology which needs wider adoption in Europe's mild and Mediterranean climates where it can bring all the benefits it is already providing to other territories across the continent.

## SAŽETAK

Europska unija je postavila ambiciozan cilj potpune ili barem gotovo potpune dekarbonizacije do 2050. Sektor zgradarstva predstavlja najveći izvor stakleničkih plinova i najveći potrošač energije na kontinentu. Pošto sve više ljudi živi u gusto naseljenim urbanim područjima, održiva opskrba energijom za grijanje prostora, hlađenje i proizvodnju tople vode postat će sve veći izazov. Centralizirani sustavi grijanja i hlađenja predstavljaju idealno rješenje u ovom procesu, budući da omogućuju proizvodnju i korištenje obnovljive i otpadne energije na mjestima gdje su dostupne, te njihovu distribuciju do mjesta na kojima su potrebne s visokim gustoćama energije. Također omogućuju povećanu fleksibilnost u smislu korištenja tehnologija proizvodnje energije pošto je većina sustava te troškova vezana uz distribucijsku stranu koja se u suštini sastoji od cijevi za toplu vodu i sustava za distribuciju te vode. Korištenje centraliziranih sustava za grijanje i hlađenje u kombinaciji s tehnologijama pretvorbe električne u toplinsku energije te sustava pohrane topline može osigurati povećanje fleksibilnosti cjelokupnog energetskeg sustava i time povećati njegovu sposobnost korištenja intermitentnih izvora obnovljive električne energije.

Glavni cilj ovog doktorskog rada je procjena i kvantifikacija utjecaja centraliziranih sustava grijanja i hlađenja na potencijal za korištenje intermitentnih obnovljivih izvora energije u umjerenim i mediteranskim klimama. Hipoteza rada je da visok udio centraliziranih sustava grijanja i hlađenja u kombinaciji s tehnologijama pretvorbe električne u toplinsku energiju i sustava pohrane toplinske energije može imati značajan i pozitivan utjecaj na potencijal energetskeg sustava za korištenje viših udjela intermitentnih obnovljivih izvora za proizvodnju električne energije bez stvaranja kritičnih viškova električne energije u kontinentalnim i mediteranskim klimama u Europi. Doktorski rad temelji se na šest radova, od čega četiri objavljena u CC časopisima visokog faktora odjeka, jednom u časopisu kategorije Q2 i jednom konferencijskom radu.

Prikazani rezultati su potvrdili predloženu hipotezu. Kako je vidljivo u rezultatima rada, sustavi s visokim udjelom centraliziranih sustava grijanja i hlađenja lako bi mogli prihvatiti 4.000 MW vjetra i 4.000 MW solarnih elektrana što bi proizvelo više od 17,13 TWh električne energije ili oko 73% ukupne potražnje za električnom energijom (uključujući dodatnu potražnju za proizvodnju topline putem dizalica topline i električnih bojlera), s oko 5% kritičnog viška proizvodnje električne energije. Rezultati također pokazuju da centralizirani sustavi hlađenja, iako predstavljaju znatno manju potražnju od grijanja te se u scenarije uključuju sa znatno manjim udjelima, još uvijek smanjuje kritični višak proizvodnje električne energije za dodatnih 12% kada se uspoređuju scenariji s i bez hlađenja.

Potreba za upravljanjem potražnjom i fleksibilnošću energetskeg sustava sve je važnija kako raste udio intermitentnih izvora obnovljive energije poput vjetra i solarne energije. Širokom primjenom sustava centraliziranog grijanja i hlađenja omogućuje se ta fleksibilnost, uz istovremeno pružanje prilagodljivog i održivog izvora energije za grijanje i hlađenje gusto naseljenih europskih gradova. To je iznimno bitna tehnologija koja zahtijeva šire prihvaćanje u umjerenim i mediteranskim klimama u Europi, gdje može donijeti sve prednosti koje već pruža drugim dijelovima europskog kontinenta.

## PROŠIRENI SAŽETAK

### *Ključne riječi:*

centralizirani toplinski sustavi, centralizirani sustavi hlađenja, energetska planiranja, GIS, pretvorba električne energije u toplinsku, pretvorba električne energije u hlađenje

Kako bi se ostvarili ambiciozni ciljevi koje je Europska Unija postavila za svoje članice, nužno je riješiti izazov dekarbonizacije gusto naseljenih gradova. Jedan od ključnih problema tog postupka upravo je održiva opskrba energije za grijanje i hlađenje. Centralizirani sustavi grijanja i hlađenja predstavljaju idealno rješenje ovog izazova pošto omogućuju proizvodnju i korištenje obnovljive i otpadne energije na lokacijama gdje je ona dostupna te njezinu distribuciju na mjesta gdje je potrebna uz dovoljno visoku gustoću energije. Dodatno, ovakvi sustavi omogućuju fleksibilnost u pogledu tehnologija proizvodnje odnosno izvora energije pošto je većina sustava te troškova vezanih uz te sustave sadržana u distribucijskoj mreži koja se u svojoj suštini sastoji od cijevi i sustava za distribuciju vode. Uporaba sustava centraliziranog grijanja i hlađenja u kombinaciji s tehnologijama pretvorbe električne u toplinsku energiju te sustavima pohrane topline, također može značajno povećati ukupnu fleksibilnost energetskih sustava i time povećati njihovu sposobnost korištenja intermitentnih obnovljivih izvora energije. S obzirom na to da takvi sustavi iziskuju značajna ulaganja i radove kako bi se mogli implementirati, njihova izvedivost uvelike ovisi o dostupnosti visokih gustoća potražnje za grijanjem i hlađenjem, kao i mogućnostima za korištenje jeftinih i održivih izvora energije.

Glavni cilj ovog doktorskog rada je analiza i kvantificiranje utjecaja centraliziranih toplinskih sustava te centraliziranih sustava grijanja i hlađenja na potencijal za korištenje intermitentnih obnovljivih izvora energije u umjerenim i mediteranskim klimama. Predložena hipoteza tvrdi kako visok udio takvih sustava koji koriste tehnologije za pretvorbu električne u toplinsku energiju te sustave za pohranu toplinske energije mogu imati značajan i pozitivan utjecaj na potencijal cjelokupnog energetskog sustava za integraciju viših udjela intermitentnih obnovljivih izvora za proizvodnju električne energije bez stvaranje prekomjernih viškova električne energije u europskim kontinentalnim i mediteranskim klimama. U tu svrhu, istraživanje provedeno u okviru ovog rada usredotočilo se na tri ključna elementa odnosno istraživačka pitanja, i to: 1) procjenu ukupne i prostorno raspodijeljene potražnje za grijanjem i hlađenjem; 2) procjenu potencijala za korištenje centraliziranih sustava grijanja i hlađenja

sustava; i 3) procjenu utjecaja tih sustava na potencijal za integraciju intermitentnih obnovljivih izvora energije za proizvodnju električne energije. U tu je svrhu razvijena metoda za prostornu analizu potražnje za grijanjem i hlađenjem s naglaskom na korištenje javno dostupnih podataka te je ista primijenjena na slučajevima Republike Hrvatske i Grada Zagreba. Zatim je razvijena metoda za procjenu izvedivosti sustava centraliziranog grijanja i hlađenja te je ona primijenjena na istom skupu primjera. Na posljertku je model H2RES nadograđen potrebnim funkcionalnostima te primijenjen za procjenu utjecaja tih sustava na potencijal za integraciju fotonapona i energije vjetrova za proizvodnju električne energije u sustavima s različitim razinama korištenja centraliziranog grijanja i/ili hlađenja.

Ovaj se doktorski rad temelji na šest radova, od kojih su četiri objavljena u časopisima visokog faktora utjecaja, jedan u Q2 časopisu te jednom konferencijskom radu. Rad 1 predstavlja početne korake razvoja metode za prostornu procjenu potražnje za energijom za grijanje na primjeru srednje velikog grada. Rad 2 prikazuje daljnji razvoj predložene metode, koji uključuje element procjene isplativosti sustava centraliziranog grijanja te dalje unaprjeđuje prostornu procjenu potražnje za energijom za grijanje. Rad 3 prikazuje rezultate analize procjene utjecaja elektrifikacije sektora prijevoza na povećanje fleksibilnosti energetske sustava i njihove sposobnosti za integraciju velikih udjela intermitentnih obnovljivih izvora energije. Rezultati ovog rada služe kao referentna točka za sposobnost centraliziranih toplinskih sustava da učine isto i omogućuje dodatne usporedbe utjecaja i potencijala. Konačna metoda za prostornu procjenu potražnje za toplinom i procjenu isplativosti centraliziranih toplinskih sustava, koristeći uglavnom javne podatke, razrađena je i prikazana u Radu 4, dok Rad 5 prikazuje isto za centralizirane sustave hlađenja. Naposljetku, Rad 6 predstavlja nadogradnju implementiranu u modelu H2RES te rezultate procjene utjecaja visokih udjela centraliziranih sustava grijanja i hlađenja na povećanje potencijala integracije intermitentnih obnovljivih izvora energije u energetske sustave. Republika Hrvatska, odnosno 9 gradova u kontinentalnim i mediteranskim klimama, korištena je kao studija slučaja za ovu analizu.

Rezultati prikazani kroz šest navedenih radova kao i sam doktorski rad uspješno su potvrdili predloženu hipotezu. Radovi 4 i 5 prikazuju visok potencijal za korištenje centraliziranih sustava grijanja odnosno hlađenja u promatranim područjima, dok rad 6 pokazuje značajan i pozitivan utjecaj tih sustava na fleksibilnost cjelokupnog energetske sustava te tim i povećanje potencijala za integraciju intermitentnih obnovljivih izvora energije na kontinentalnom i mediteranskom klimatskom području. Kao što se vidi iz rezultata rada 6, energetske sustavi s

visokim udjelom centraliziranih sustava grijanja i hlađenja lako bi mogli apsorbirati 4.000 MW energije vjetra i 4.000 MW fotonaponskih elektrana, što bi proizvelo više od 17,13 TWh električne energije, ili otprilike 73% ukupne potražnje za električnom energijom u tom slučaju (uključujući dodatnu potražnju za proizvodnju toplinske energije putem dizalica topline i električnih kotlova) s otprilike 5% CEEP-a. U usporedbi, ukupna potražnja za električnom energijom za cijelu Republiku Hrvatsku iznosi 18,32 TWh u referentnom slučaju. Rezultati također pokazuju da centralizirani sustavi hlađenja, iako predstavlja mnogo manju potražnju od sustava grijanja i integrirani su u scenarije s mnogo manjim udjelima, još uvijek smanjuje proizvodnju viška električne energije za do dodatnih 12% u usporedbi sa scenarijima bez hlađenja.

Upravljanje potražnjom i fleksibilnost energetske sustava postaju sve važnije teme kako se povećava udio obnovljivih izvora energije, a posebno intermitentnih izvora poput vjetra i sunca. Centralizirani sustavi grijanja i hlađenja se pokazuje kao ključni element u ovom procesu i resurs s iznimno visokim potencijalom pružanja usluga fleksibilnosti elektroenergetskoj mreži. To je dodatna korist već dokazanom potencijalu takvih sustava za održivu opskrbu energije za grijanje i hlađenje iz različitih izvora. Centralizirani sustavi grijanja i hlađenja ključne su tehnologije koja će biti nužno šire primjenjivati u kontinentalnim i mediteranskim klimama Europe, gdje mogu donijeti sve prednosti koje već pružaju na drugim teritorijima diljem kontinenta.

### **CILJ I HIPOTEZA**

Hipoteza ovog istraživanja je da široka primjena sustava centraliziranog grijanja i hlađenja u umjerenim i mediteranskim klimama može postići visoku razinu integracije intermitentnih obnovljivih izvora energije, poput vjetra i sunca, te smanjiti emisije stakleničkih plinova, u skladu s prethodnim istraživanjima na tu temu u sjevernim dijelovima Europe.

Cilj ovog istraživanja je ispitati utjecaj sustava centraliziranog grijanja i hlađenja na integraciju obnovljivih izvora energije u energetske sustave u umjerenim i mediteranskim klimama s aspekta energetske planiranja.

### **ZNANSTVENI DOPRINOS**

Znanstveni doprinos ovog doktorskog rada temelji se na popunjavanju tri ključna identificirana istraživačka jaza: ovisnost prostornih procjena potražnje za energijom za grijanje i hlađenje o velikoj količini detaljnih podataka, nedostatak alata za procjenu izvedivosti centraliziranih

sustava grijanja i hlađenja za široka područja primjene te nedostatak istraživanja o kvantificiranim utjecajima primjene centraliziranih sustava grijanja i hlađenja na potencijal primjene intermitentnih obnovljivih izvora energije.

Procjena potražnje za energijom za grijanjem i hlađenjem često se oslanja na velike količine podataka visoke razlučivosti koji često nisu dostupni ili barem nisu javni. Istraživanje predstavljeno u ovom doktoratu te priloženim radovima prikazuje metodu koja se fokusira na upotrebu javnih podataka, što ju čini fleksibilnom i široko primjenjivom. Predstavljena metoda demonstrirana je na području Grada Zagreba te Republici Hrvatskoj.

Predstavljena metoda za procjenu izvedivosti centraliziranih sustava grijanja i hlađenja predstavlja manje zahtjevnju alternativu po pitanju potrebe za podacima, no ipak uzima u obzir lokalne uvjete, poput potencijala za korištenje lokalno dostupnih izvora energije.

Na posljertku, predstavljeno istraživanje prikazuje utjecaj centraliziranih sustava grijanja i hlađenja na povećanje fleksibilnosti energetskog sustava te omogućavanje veće stope primijene intermitentnih obnovljivih izvora energije u blagim i mediteranskim klimama. Ovi rezultati pružaju dodanu znanstvenu vrijednost, budući da istraživanje utjecaja istovremene primjene centraliziranih sustava grijanja i sustava hlađenja nije široko rasprostranjeno, za razliku od istraživanja na bazi samo sustava grijanja, te utjecaj obje konfiguracije sustava nije jasno definiran u geografskim i klimatskim područjima obuhvaćenim ovim istraživanjem.

### **METODE I POSTUPCI**

Provedeno istraživanje bazira se na tri metode: metoda prostorne procjene potražnje za energijom za grijanje i hlađenje, metodom procjene izvedljivosti centraliziranih sustava grijanja i hlađenja te metodi analize utjecaja tih sustava na potencijal primjene intermitentnih obnovljivih izvora energije.

Prostorna procjena potražnje za energijom za grijanje i hlađenje te procjena izvedljivosti centraliziranih sustava za grijanje i hlađenje provedeni su korištenjem alata qGIS za upravljanje georeferenciranim podacima. Objie su metode bazirane na primjeni većinski javno dostupnih podataka. Rezultati provedenih procjena predstavljaju bazu za daljnje analize u trećem koraku cjelokupne metode.

Analiza utjecaja sustava centraliziranog grijanja i hlađenja na potencijal primjene intermitentnih obnovljivih izvora provedena je pomoću energetskog modela H2RES koji

omogućava optimizaciju energetske sustava te modeliranje njihova vođenja. Provedena analiza pokazala je iznimno snažan i pozitivan utjecaj primjene centraliziranih sustava grijanja i hlađenja na povećanje fleksibilnosti cjelokupnog energetske sustava odnosno mogućnosti primjene intermitentnih obnovljivih izvora energije.



## **KEYWORDS**

*District heating*

*District cooling*

*Energy planning*

*GIS*

*Power to heat*

*Power to cold*

## **KLJUČNE RIJEČI**

*Centralizirani toplinski sustavi*

*Centralizirani sustavi hlađenja*

*Energetsko planiranje*

*GIS*

*Pretvorba električne energije u toplinsku*

*Pretvorba električne energije u hlađenje*

## TABLE OF CONTENTS

BIBLIOGRAPHY DATA .....	I
MENTOR .....	II
ACKNOWLEDGEMENT .....	III
PREFACE .....	IV
Summary .....	V
Sažetak .....	VI
Prošireni sažetak.....	VII
Keywords .....	XII
Ključne riječi.....	XII
List of abbreviations.....	XVI
Nomenclature .....	XVII
List of Figures .....	XIX
List of Tables.....	XXI
1 Introduction .....	1
1.1 Background and motivation .....	1
1.2 Knowledge gap analysis and scientific contribution.....	3
1.2.1 Literature review .....	3
1.2.2 Knowledge gap.....	5
1.2.3 Scientific contribution .....	6
1.3 Objective and hypotheses of research .....	7
2 Methods.....	8

2.1	Spatial heating and cooling demand assessment.....	8
2.1.1	Heat demand mapping.....	8
2.1.2	Cooling demand mapping .....	12
2.1.3	Implementation of the heating and cooling demand mapping methods.....	15
2.2	Assessment of the potential for the utilization of DH and DC.....	20
2.3	Assessment of the impact of DH and DC on the potential for the utilization of intermittent renewable electricity generation.....	21
2.3.1	The H2RES model .....	22
2.3.2	Scenario creation and implementation of the H2RES model.....	27
3	Selected results and discussion .....	31
3.1	Bottom-up and top-down heating and cooling demand .....	31
3.2	District heating and cooling potential .....	35
3.3	Impact of district heating and cooling on the potential for the utilization of variable electricity generation .....	45
3.4	Discussion .....	58
4	Conclusions and future work.....	61
5	Literature .....	64
6	Curriculum vitae.....	72
7	Summary of papers.....	73
	Paper 1 .....	79
	Paper 2.....	87
	Paper 3.....	94
	Paper 4.....	112

Paper 5.....	136
Paper 6.....	176

## LIST OF ABBREVIATIONS

Abbreviation	Meaning
CEEP	Critical excess of electricity
COP	Coefficient of performance
DHP	Combined heat and power
DC	District heating
DHC	District heating and cooling
DH	District cooling
DHW	Domestic hot water
EU	European Union
GIS	Geographic information System
LCOC	Levelized cost of cooling
LCOH	Levelized cost of heating
PV	Photovoltaics

## NOMENCLATURE

### *Chemical formulas*

CO<sub>2</sub>     carbon dioxide

### *Variables and parameters*

*(CP-LCOC)*     Difference between the price and the levelized cost of cooling [EUR/MWh]

*(HP-LCOH)*     Difference between the price and the levelized cost of heat [EUR/MWh]

*A*                Gross building footprint area [m<sup>2</sup>]

*AC<sub>n</sub>*            Area of the modified CORINE land cover category n within grid tile i [m<sup>2</sup>]

*A<sub>g</sub>*                Gross building footprint area [m<sup>2</sup>]

*CC<sub>g</sub>*            Specific cost of the cooling grid [EUR/year/m]

*CD*                Total cooling demand [MWh/year]

*CD<sub>1km</sub>*        Cooling demand in a 1km radius [MWh/year]

*CDS*                Specific cooling demand [kWh/m<sup>2</sup>/year]

*C<sub>g</sub>*                Average cost of grid per observed square [EUR]

*FH*                Floor height [m]

*H*                 Building height [m]

*H*                 Total height of the building [m]

<i>HD</i>	Heat demand [MWh/year]
<i>HD<sub>i</sub></i>	Heating demand of grid tile <i>i</i> [MWh]
<i>HD<sub>mx</sub></i>	Aggregate heating demand for municipality <i>x</i> [MWh]
<i>HD<sub>nBU</sub></i>	Heat demand of cell <i>n</i> calculated using the bottom-up method [MWh]
<i>HD<sub>nTD</sub></i>	Heat demand of cell <i>n</i> calculated using the top-down method [MWh]
<i>HDS</i>	Specific heat demand per building type [MWh/m <sup>2</sup> /year]
<i>HF</i>	Floor height [m]
<i>Lg1km</i>	Length of the cooling grid in a 1km radius [m]
<i>m</i>	Grid tile within municipality <i>x</i> [-]
<i>n</i>	CORINE land cover categories [-]
<i>NG</i>	Net to gross area ratio per building type [-]
<i>NGR</i>	Net area to gross surface area ratio [-]
<i>P</i>	Modified population density in one grid tile [-]
<i>WfC<sub>n</sub></i>	Weight factor for the CORINE land cover category <i>n</i> [1/m <sup>2</sup> ]
<i>Wfp</i>	Weight factor for the population density [-]

## LIST OF FIGURES

<i>Figure 1 Spatial distribution of roads, bodies of water and natural areas .....</i>	<i>16</i>
<i>Figure 2 CORINE land cover map; original data (up) and modified data (down) .....</i>	<i>17</i>
<i>Figure 3 population density map; original data (up) and modified data (down) .....</i>	<i>18</i>
<i>Figure 4: Representation of the H2RES model .....</i>	<i>23</i>
<i>Figure 5: Representation of the Heating sector in H2RES .....</i>	<i>25</i>
<i>Figure 6 Final Top-down heating demand map (Top left: Zagreb, Top right: Osijek, Bottom left: Split, Bottom right: Rijeka) .....</i>	<i>31</i>
<i>Figure 7 Comparison of the top-down (top) and bottom-up (bottom) heating demand maps for the City of Zagreb .....</i>	<i>32</i>
<i>Figure 8 Final Top-down cooling demand map (Top left: Zagreb, Top right: Osijek, Bottom left: Split, Bottom right: Rijeka) .....</i>	<i>33</i>
<i>Figure 9 Comparison of the top-down (top) and bottom-up (bottom) cooling demand maps for the City of Zagreb .....</i>	<i>34</i>
<i>Figure 10 District heating potential with grid cost of 5.000 EUR/ha (Top left: Zagreb, Top right: Osijek, Bottom left: Split, Bottom right: Rijeka) .....</i>	<i>35</i>
<i>Figure 11 District heating potential with grid cost of 10.000 EUR/ha (Top left: Zagreb, Top right: Osijek, Bottom left: Split, Bottom right: Rijeka) .....</i>	<i>36</i>
<i>Figure 12 District heating potential with grid cost of 15.000 EUR/ha (Top left: Zagreb, Top right: Osijek, Bottom left: Rijeka, Bottom right: Split) .....</i>	<i>36</i>
<i>Figure 13 Comparison of the viability of district cooling for the City of Zagreb (Top: Top-down, Bottom: Bottom-up) .....</i>	<i>40</i>
<i>Figure 14 Viability of district cooling at a grid price of 250 EUR/m (Top left: Zagreb, Top right: Osijek, Bottom left: Split, Bottom right: Rijeka) .....</i>	<i>42</i>
<i>Figure 15 Viability of district cooling at a grid price of 500 EUR/m (Top left: Zagreb, Top right: Osijek, Bottom left: Split, Bottom right: Rijeka) .....</i>	<i>43</i>



<i>Figure 16 Viability of district cooling at a grid price of 750 EUR/m (Top left: Zagreb, Top right: Osijek, Bottom left: Split, Bottom right: Rijeka)</i> .....	43
<i>Figure 17 Viability of district cooling at a grid price of 1000 EUR/m (Top left: Zagreb, Top right: Osijek, Bottom left: Split, Bottom right: Rijeka)</i> .....	44
<i>Figure 18 CEEP for all scenarios with electrical boiler limit of 600 MW</i> .....	46
<i>Figure 19 CEEP for all scenarios with electrical boiler limit of 2.500 MW</i> .....	46
<i>Figure 20 Installed capacity of Heat pumps [MW] for all scenarios with a 600 MW limit on electric boilers</i> .....	50
<i>Figure 21 Installed capacity of Heat pumps [MW] for all scenarios with a 2.500 MW limit on electric boilers</i> .....	51
<i>Figure 22 Installed capacity of Electric boilers [MW] for all scenarios with a 600 MW limit on electric boilers</i> .....	52
<i>Figure 23 Installed capacity of Electric boilers [MW] for all scenarios with a 2.500 MW limit on electric boilers</i> .....	53
<i>Figure 24 Installed capacity of Heat storage [MWh] for all scenarios with a 600 MW limit on electric boilers</i> .....	55
<i>Figure 25 Installed capacity of Heat storage [MWh] for all scenarios with a 2.500 MW limit on electric boilers</i> .....	56
<i>Figure 26 Export of electricity for scenarios with wind (top) and PV (bottom)</i> .....	57
<i>Figure 27 CEEP for the comparison scenarios with wind generation</i> .....	59
<i>Figure 28 CEEP for the comparison scenarios with PV generation</i> .....	60

## LIST OF TABLES

<i>Table 1 Reference aggregate and calculated bottom-up data for the city of Zagreb .....</i>	<i>16</i>
<i>Table 2: Main input data files in H2RES .....</i>	<i>26</i>
<i>Table 3 Scope of the case study.....</i>	<i>27</i>
<i>Table 4 List of the developed scenarios .....</i>	<i>30</i>
<i>Table 5 District heating potential for the City of Zagreb at a resolution of 1ha.....</i>	<i>37</i>
<i>Table 6 District heating potential for Croatia at a resolution of 1ha.....</i>	<i>38</i>
<i>Table 7 Sensitivity assessment off the viability of district cooling to the cost of the cooling network – Bottom-up and Top-down results for the City of Zagreb .....</i>	<i>41</i>
<i>Table 8 Results of the assessment of the viability of district cooling – Top-down results for Croatia .....</i>	<i>45</i>
<i>Table 9 CEEP for all scenarios.....</i>	<i>47</i>
<i>Table 10 Installed capacity of Heat pumps [MW] for all scenarios with a 600 MW limit on electric boilers.....</i>	<i>49</i>
<i>Table 11 Installed capacity of Heat pumps [MW] for all scenarios with a 2.500 MW limit on electric boilers.....</i>	<i>50</i>
<i>Table 12 Installed capacity of Electric boilers [MW] for all scenarios with a 600 MW limit on electric boilers.....</i>	<i>51</i>
<i>Table 13 Installed capacity of Electric boilers [MW] for all scenarios with a 2.500 MW limit on electric boilers.....</i>	<i>52</i>
<i>Table 14 Installed capacity of Heat storage [MWh] for all scenarios with a 600 MW limit on electric boilers.....</i>	<i>54</i>
<i>Table 15 Installed capacity of Heat storage [MWh] for all scenarios with a 2.500 MW limit on electric boilers.....</i>	<i>55</i>
<i>Table 16 results of the comparison scenarios .....</i>	<i>58</i>

# 1 INTRODUCTION

## 1.1 Background and motivation

The European Union (EU) has set a goal of a total or at least near-total decarbonisation until 2050 [1]. The timeline to achieve these targets as well as their intensity has been growing ever more ambitious over the past years as evident in the evolution from the initial plans to the most recent ones outlined within REPowerEU [2]. Most of the overall greenhouse gas emissions are a direct result of fuel combustion and fugitive emissions from fuels (without transport) with 2420 million tonnes of CO<sub>2</sub> equivalent or 54% in 2017 [3]. Buildings represent the single largest contributor being the largest single energy consumer, 40%, and greenhouse gas emitter, 36%, across the EU [4]. These figures are bound to increase since, according to the 2018 Revision of World Urbanization Prospects, 55% of the total World population is currently living in urban areas and this will most likely increase to 68% by 2050 [5]. As more and more people move into densely populated urban areas the sustainable provision of energy for space heating, cooling and production of domestic hot water will become an ever-increasing issue. Heating represents the largest demand both in terms of total annual and peak loads in 25 EU countries among heating cooling and electricity demand, although that could change in the future due to ever increasing electrification [6]. Energy efficiency increases can help alleviate the issue, but it becomes uneconomical after a point and energy production from renewable sources becomes cheaper than further efficiency increases. Additionally, no matter the level of energy efficiency, energy will be required for the generation of domestic hot water (DHW).

Due to the inefficiency of the transport of heating and cooling energy at long distances, the options for sustainable provision of energy for heating and cooling is limited, especially in the cases of densely populated urban areas. The use of fossil fuels in individual boilers is not compatible with the vision of a decarbonised Europe by 2050, individual biomass fired boilers will pose significant logistical problems related to the supply of fuel and management of ash alongside potential environmental issues linked to particulate emissions, individual resistive electric heating will be sensitive to increases in electricity prices and can have negative effects on peak electricity demand while individual heat pumps can face issues due to space constraints and price.

District heating (DH) presents itself as a key solution due to its ability to utilize waste and renewable energy and distribute it from its source to its consumers. Waste heat is an especially important factor since it is clean, cheap and abundant as shown in [7] for an example of 33 countries and [8] for northern China. Additionally, DH can enable the utilization of sources such as solar [9] and geothermal [10] energy as well as heat pumps [11] where they are available or feasible and transport the energy to where it is needed. Since it is essentially a distribution technology, DH provides great flexibility with regards to the use of energy sources and transformation technology and enables the utilization of several energy vectors at once. It is also a crucial component of future smart energy systems and a key driver for a higher level of integration of renewable energy sources (RES) since it can provide flexibility to the electrical grid if power to heat technologies are used [12][13][14].

DH is however not always economically feasible due to its high initial investment costs, so a detailed investigation is needed to determine if and in which areas it should be utilized. Its feasibility depends on three key factors:

1. Heat demand density;
2. Required supply temperature;
3. Availability of waste energy and RES.

Spatial analyses are vital in these assessments and can help tackle these questions as well as provide, depending on the scope of the investigation, an initial or a detailed analysis of the areas suitable for the utilization of DH. Geographic information system (GIS) based tools such as qGIS [15] and ArcGIS [16] enable such operations.

The results of these assessments rely heavily on the availability and quality of data, both aggregated and spatially distributed. This data is often not available or at least not public which can result in the inability to perform spatial assessments of the energy demand or hinder the ability to validate the outcomes.

All of the positive impacts, as well as the limitations and potential barriers, mentioned for DH are also true for district cooling (DC) as well as district heating and cooling (DHC). The integration of heating and cooling into one coherent system can enhance the decarbonisation potential and the overall increase in flexibility of the system as a whole, through the exploitation of the potential synergies. Naturally, the overall complexity and the initial costs increase as well making quality planning even more essential.

## **1.2 Knowledge gap analysis and scientific contribution**

### **1.2.1 Literature review**

Unlike electricity which can be transported long distances with relatively low losses, heat and cooling needs to be produced and consumed in a restricted geographic area. Linear thermal and pressure losses represent technical, while the cost of the needed infrastructure impose economic limitations for viable distances of heating and cooling energy distribution. Due to these reasons, spatial assessments of heat demand and supply are a crucial tool for DH, DC and DHC planning.

GIS is a powerful and often used tool in the spatial assessment of energy supply and demand potentials. Examples include assessments of wind [17], geothermal [18], solar [19], photovoltaics (PV) [20], wind and solar [21], tidal [22] biomass [23] and biogas from manure [24] as well as manure and agricultural waste [25]. It has also been used in the assessment of specific sectors relevant to highly populated urban areas such as the prediction of urban heat islands [26], energy demand of cultural buildings [27], algae production [28] and the viability of hydrogen for road transport [29].

Several examples of the utilization of GIS for heat mapping and DH assessments can be found in literature. [30] for example presents a methodology utilizing land use and population density data alongside national averages for heating demand to produce a heat map for the city of Sheffield. The authors expect an error in the range of 20-25% based on the limitation of the utilized data. Similarly to that approach, the authors of [31] used national statistics for the US, divided into 11 census regions in order to calculate per capita heat demand and develop a heat atlas for the continental US. The calculation has taken average heating degree days for every state as well as land use and population density data. An assessment of the potential for the utilisation of DH has been conducted based on a minimum demand threshold. Degree day and highly detailed population data have been used to develop a top-down heat demand map of Switzerland in [32]. On the other hand, the authors of [33] utilized detailed georeferenced building stock data including information on the type, use and age of buildings as well as the accounts of Danish energy producers to develop a heat atlas as well as an assessment of the potential for the utilization of DH in comparison to heat pumps. Utilizing even more data including the Danish Buildings and Dwellings registry, energy audits and detailed energy databases in [34], the authors have created a heat atlas with a resolution of a single building. When compared to measured consumption data the mean error ranged from 1% for industry

and private sector service buildings, 15% for multi-story dwellings to 50% for public research and education buildings. The potential for the utilization of DH has been assessed using cost-supply curves. The same database has been used in [35] for the development of a heat atlas in one Danish municipality and assess the costs of energy savings measures. The authors of [36] utilized the atlas developed in [34] in order to assess the viability of using low temperature heat sources, such as low temperature industry excess heat, supermarkets, wastewater, drinking and sewage water, ground water, rivers, lakes and sea water in DH via heat pumps. The authors of [37] used similarly detailed data, including measured energy consumption, census and detailed building data to develop an energy atlas for a limited area including 3600 buildings. The authors of [38] used a multilinear regression model to disaggregate the cities energy consumption data to a single dwelling level, based on building and household data for the city of Rotterdam for gas and electricity. Detailed bottom-up heat demand assessment has been conducted using a 3D model of the city and building stock data. The results were then aggregated to comply with data privacy regulations. Multilinear regression has also been utilized in [39] to develop a top-down heat demand map for 14 of the EUs largest countries. The model has been calibrated using Denmark as a reference due to its detailed building registry. A fixed minimum supply density of 20 TJ/km<sup>2</sup> has been used to assess the viability of DH utilization. The viability of the utilization of sewage heat in DH in Tokyo has been assessed in [40]. A bottom-up method utilizing building polygons, heights and type of buildings has been used to generate the heat map while spatial correlations of demand and potential supply have been utilized to assess the feasibility.

On the other hand, the spatial assessment of cooling demand and the viability of district cooling is still under-explored. Some research into the topic does exist, for example the Pan-European Thermal Atlas developed under the Heatroadmap Europe project, does include cooling demand assessments [41], [6], however the focus is firmly placed on the aspect of heat supply and demand. The authors of [42] have proposed a method to use electricity consumption data to assess actual cooling needs with high accuracy while the authors of [43] have correlated cooling demand with local climate data and real estate prices for the case of Seoul. Both methods require detailed data which is often not available, such as remote metering data in the case of the former and microclimate data in the case of the later work. The lack of research into the use of DC when compared to heating is likely linked to its lower rate of utilisation. Most of the benefits and the limitations of DH are valid for DC as well. It enables the utilization of otherwise unusable cooling sources such as free and waste cooling [44], [45], as well as the diversification

of supply options [46]. As with heating, DC is most suited for high-density urban areas [47], [48] where it can lead to significant efficiency gains [49]. DC provides the potential to supply renewable cooling at higher energy densities, lower costs and with lower land use, compared to individual systems thus making them a vital component in the decarbonisation of the building sector and the overall sustainability of the energy supply in densely populated urban areas. The high investment costs in such systems as well as the reliance of its economic feasibility on the spatial conditions and the location of the potential supply and demand make GIS based tools ideal for the assessment of its potential. The quality of these assessments is, similarly to assessments of DH, reliant on the quality and availability of data which is often not accessible.

A key benefit of DH systems is their potential to provide flexibility to the overall energy system if correctly configured [50]. The use of power-to-heat technologies such as heat pumps, heat storage and combined heat and power (CHP) units can enable systems to interact with the power system and provide additional potential for the integration of variable RES such as wind and solar [51][14]. For instance, in systems with a high share of such variable sources a critical excess of electricity production (CEEP) can become an issue and cause curtailment of production. Heat pumps and electric heaters can transform this excess electricity into heat and either distribute it via a DH network or store it for later use. At instances when a lack of electricity occurs, these systems can be switched off and stored heat can be used while CHP units can be engaged to produce additional power and heat which can be either stored or supplied [13]. Such a configurations can provide benefits on both the heat and power markets and enable additional revenues and market opportunities to DH operators. This potential can be additionally exploited if DC is integrated into the overall system as well, as they introduce an additional demand further prolonging the overall hours of operation and opening new potentials for operations on the energy markets.

### **1.2.2 Knowledge gap**

The importance of DH as an option for the sustainable supply of heat and the utilization of various RES such as geothermal [10] and solar [9] as well as waste heat [52] is very well researched as is its potential to act as mechanism to link the power and heating sectors [13]. This is also true for the use of Geographic information system (GIS) based tools such as qGIS [15] and ArcGIS [16] in the assessments of their potential and viability [53]. One common thread between all of them is the need for quality data. This makes the development of high-resolution heat maps and assessments of DH potentials in data-poor areas difficult. The

assessment of the viability of DH in these cases is usually handled through fixed minimum heat demand densities or through the development of heat cost curves. The former gives a quick and broad overview of the available potential but does not take the impact of potentially cheap sources of heat into account while the latter relies on the availability of detailed technical and economic data. On the other hand, research into the assessment of cooling demand and the viability of DC is far less common as is the impact DC and DHC can have on the increase of flexibility of energy systems and the increase of the potential for the utilization of intermittent renewables for power generation. Additionally, the research which exists on the topic is, similarly to the research on DH, reliant on the availability of large quantities of high-resolution data.

In terms of the existing research on the impacts of DH, DC and DHC on the flexibility of the overall energy system, meaning the potential increase for the integration of intermittent RES, studies are mostly focused on the use of DH and its impact in central and northern Europe, although some wider studies do exist. DC and DHC are far less researched and their impacts on the potential for the increase of the overall energy systems flexibility is still underexplored.

### **1.2.3 Scientific contribution**

The research presented in this work aims to close the identified knowledge gap in terms of both the methods for the assessment of the viability of DH, DC and DHC and their impact on the potential for the utilization of intermittent RES in mild and Mediterranean climates.

As stated, quality assessment of heating and cooling demand is often reliant on large quantities of high-resolution data which is lacking for most areas. The research presented in the papers attached to this thesis demonstrate a method focused on the use of public data and data available to most, if not all, local and regional governments in Europe, thus resulting in a flexible and widely applicable method. Additionally, the method developed for the assessment of DH and DC viability also presents a less data intensive alternative while still taking local conditions, such as the potential to utilise cheap waste heat, into account.

Finally, the presented research demonstrates the impact DH and DHC can have on the increase of the flexibility of the energy system as a whole and enabling a higher share of intermittent RES in mild and Mediterranean climates. These results provide added scientific value as the impact of DHC is not widespread, unlike DH, and the impact of DH and DHC were not clearly defined in the geographic and climatic areas covered by this research.



### **1.3 Objective and hypotheses of research**

The hypothesis of this research is that a widespread utilization of DHC in moderate and Mediterranean climates can accomplish an economically feasible level of intermittent RES, for example wind and solar, penetration and reduce the greenhouse gas emission, in line with the previous research done with regards to DH in northern climates.

The goal of this research is to examine the impact of DHC on the integration of RES in future energy systems in moderate and Mediterranean climates from the perspective of energy planning. Because of their interdependence, the interaction between DHC as well as the impact of their integration with the power system on the energy sector as a whole will also be analysed within this work. The Republic of Croatia will be used as a case study for this analysis.

# 2 METHODS

The following chapter will cover the three key elements of the conducted research:

1. Spatial assessment of heating and cooling demand
2. Assessment of the viability for the utilization of DH and DC
3. Assessment of the impact of DH and DC on the potential to utilize intermittent RES

## 2.1 Spatial heating and cooling demand assessment

### 2.1.1 Heat demand mapping

A wide variety of methods for the assessment of heat demand, both aggregated and spatially distributed, already exist. They are however often very dependent on the availability of large quantities of high-resolution data. As such data, for instance building censuses, existing energy demand and supply maps, are often not available or public, the proposed method utilized in this research relies on public databases as much as possible. Since this will inevitably require some assumptions, a three-step approach has been proposed to calibrate and validate the results as well as assess potential errors. These steps are:

1. Calculation of aggregate heat demand;
2. Bottom-up heat demand mapping;
3. Top-down heat demand mapping.

#### 2.1.1.1 Assessment of aggregated heat demand

The first step in the process is the calculation of the aggregated heat demand of the lowest resolution level for which the data exist. Depending on the case, this could be done on the level of a country, region, municipality or lower. In the case of this research, the level of municipality has been selected as publicly available statistics exist at this resolution. Once the selection has been made, the individual heat demand of each element of the observed area can then be calculated utilizing national data and data on the selected level of resolution. In the case of this research, the following information has been collected and utilized:

- Climate zones

- Surface area of existing buildings per municipality type and climate zone;
- Share of individual building types per municipality type and climate zone;
- Specific heat demand per building category and climate zone;
- Population per climate zone;
- Population per municipality.

The total surface areas of existing buildings, categorised in four key categories: single family houses, multiapartment, private commercial and public buildings; have been collected per climate zone. Additionally, the share of each building type based on their construction period and the associated specific heat demand has also been gathered. These data have been used to calculate the total heat demand of each climate zone. Using the population data per climate zone, the specific per capita heat demand of each zone has been calculated. This, together with the population of each individual municipality, has been used to calculate the heat demand on a municipal level. This heat demand can then be disaggregated spatially using a method suitable to the location and the availability of data or used for the calibration of bottom-up calculations.

#### **2.1.1.2 Bottom-up head demand calculation and mapping**

Bottom-up energy demand calculation and mapping, in this case heat, implies the use of detailed data on a very fine resolution. In the case of this research, the selected resolution has been individual buildings. Once calculated, the building level heat demand can then be aggregated into an appropriate grid, in the case of this research a 1 ha (100 m by 100 m square) grid.

As demonstrated in [54] and [55], the bottom-up heat demand assessments can be implemented using only public data. In these cases, the public census information has been utilized to identify the locations, shapes and gross rooftop areas of buildings within the case study zones (the cities of Osijek and Velika Gorica respectively). The building types and heights (in terms of number of floors) have been determined manually for the observed area. This information, together with the publicly available data on specific heat consumptions of individual building types has then been used to calculate the per building heat demand of the observed area. This process is overall very time consuming and only viable in locations of limited area and very limited data availability.

The approach presented in [56] follows a similar logic as the one described above; however it takes into account some additional data which is available to most larger cities and which can

then be used as a reference and calibration point for the assessments conducted on a wider area. In this case, the building level heat demand calculation has been based on the following parameters:

- Building location and footprint area;
- Building height;
- Land use;
- Specific heat demand per building use category;
- Average floor height per building category;
- Net to gross surface area ratio per building category.

For this calculation, building heights and types have not been determined manually but rather using existing datasets which are either public or available to local or regional governments.

The heat demand has been calculated using Equation (1).

$$HD = A_g \cdot NG \cdot (H/FH) \cdot HD_s \quad (1)$$

HD – Heat demand [MWh/year]

$A_g$  – Gross building footprint area [m<sup>2</sup>]

NG – net to gross area ratio per building type [-]

H – Building height [m]

FH – Floor height [m]

$HD_s$  – Specific heat demand per building type [MWh/m<sup>2</sup>/year]

Once the heat demand has been calculated it can be calibrated based on the municipal level data through the modification of the floor height and net to gross surface area ratios per building category. Aside from the aggregate heat demand, the total heated surface area per building type has been compared and used for the calibration and validation of the results.

### **2.1.1.3 Top-down heat demand mapping**

Top-down heat demand mapping involves the spatial disaggregation of a heat demand for a selected area. In the case of this research, the heat demand calculated at a municipal level has

been disaggregated over the area of said municipality. Depending on their availability, building census data, detailed population densities or building distribution databases can be used. Since detailed data on a national level are often not available, or not public, other sources can be utilised. This includes public pan-European or World-wide databases. Three main sources which have been utilized in the case of this research include:

- CORINE land cover maps [57];
- Population density map [58];
- Open street maps [59].

The CORINE land cover map provides information on the dominant type of land cover within the given grid. This includes both man-made structures and nature. Since only buildings have been of interest for this research, only these layers of the CORINE land cover map have been utilized. Additionally, roads and areas covered by nature, such as parks for example, have been cut from the initial map to show a more realistic depiction of the actual situation. This map has then been intersected by a layer depicting the distribution of the municipalities and a 1ha grid. Finally, the data has been aggregated into the 1ha grid to obtain the areas per type of cover alongside the designation to which municipality each grid segment belongs. Weight factors have been applied to each of the land cover types considered and the final aggregate land cover area has been calculated.

A similar approach has been applied to the population density map. First, the specific population density per square meter has been calculated for each segment and the roads, bodies of water and natural coverage have been removed. The resulting grid has been intersected with a vector layer representing the distribution of the municipalities and the 1 ha grid. Finally, the population density of each resulting square has been recalculated. The resulting map has then been correlated with the modified CORINE land cover map and a relation between the area and population has been determined. This needs to be done since the CORINE land cover map does not recognize sparsely built areas resulting in a significant error. This is due to the fact that the CORINE map only displays the dominant cover in each grid element.

A combination of the modified CORINE land cover and population density maps have used to distribute the heat demands on a municipal level across the entire observed area into a 1 ha grid. The results of the top-down and bottom-up maps have been compared and the weight factors calibrated with a goal of minimizing the error between the two mapping methods.

Following the previous steps, the heating demand of each individual grid tile has been calculated using Equation (2).

$$HD_i = \left( \sum_{n=1}^n AC_n \cdot Wf_{Cn} + P_i \cdot Wf_P \right) * \frac{HD_{mx}}{\sum_{m=1}^m (\sum_{n=1}^n AC_n \cdot Wf_{Cn} + P_m \cdot Wf_P)} \quad (2)$$

$HD_i$  – Heating demand of grid tile i [MWh]

n – CORINE land cover categories [-]

$AC_n$  – Area of the modified CORINE land cover category n within grid tile i [ $m^2$ ]

$Wf_{Cn}$  – Weight factor for the CORINE land cover category n [ $1/m^2$ ]

P – Modified population density in one grid tile [-]

$Wf_P$  – Weight factor for the population density [-]

$HD_{mx}$  – Aggregate heating demand for municipality x [MWh]

m – grid tile within municipality x [-]

### 2.1.2 Cooling demand mapping

The overall approach with regards to the calculation and mapping of cooling demand is very similar to heating. The major difference in the two approaches is a direct result of data availability. While there is ample reference data on the actual heat consumption and calculated heat demands of certain areas do exist, such data is usually not available for cooling since it is mostly conducted via air-to-air heat pumps and is therefore aggregated in the electricity demand. With regards to calculated cooling demand, it is often not assessed in building design and therefore reference data is also lacking. Therefore, certain approximations are needed. The method proposed in this research again relies mostly on publicly available data and data available to cities and municipalities. It consists of the following 3 steps:

1. Calculation of the specific cooling demand for the selected building types;
2. Bottom-up cooling demand mapping for the reference location;
3. Top-down cooling demand mapping and calibration via the reference location.

### **2.1.2.1 Assessment of aggregated cooling demand**

The specific cooling demand of buildings depends on a variety of factors such as the buildings use category, its physical characteristics and the local climate conditions. Due to this variety, it is impossible to utilize the same sets of parameters across multiple countries, or even across multiple regions. In the case of this research, the national technical regulations and algorithms for the calculation of the heating and cooling demands of reference buildings has been utilized. This involves the Technical Regulation on the rational use of energy and thermal protection in buildings [60] and the Algorithm for the calculation of necessary energy for heating and cooling according to HRN EN ISO 13790 [61].

The required inputs for the calculation of the cooling demand such as the geometry of the building envelope, reference physical characteristics, infiltration and temperature setpoints for the given climate zone, building use category and so on, have been taken from the relevant reference datasets which are available for most European countries and usually published by the relevant ministry. In the case of this research, the data has been taken from surveys conducted by the Ministry of Physical Planning, Constriction and State Assets with the aim to make a comprehensive inventory of the existing national building stock [62]. These data and methods have been used to calculate the specific cooling demands based on building type and climate zone.

### **2.1.2.2 Bottom-up cooling demand mapping**

Bottom-up cooling demand mapping involves a similar process to that of heating demand. It involves a detailed calculation of cooling demand at a very fine resolution and its subsequent aggregation into a predetermined grid. In the case of this research, the cooling demand has initially been calculated on the level of individual buildings and then aggregated to a resolution of 1ha (square grid with 100m sides). The initial building level cooling demand for each individual building has been calculated using the same basic inputs as in the case of heating with the specific heating demand being replaced with the specific cooling demand.

The cooling demand has been calculated using Equation (3). In essence, the equation represents a multiplication of the specific cooling demand of an individual building based on its type in kWh/m<sup>2</sup> and its net cooled area in m<sup>2</sup>.

$$CD = A \cdot NGR \cdot (H/H_F) \cdot CD_S/1000 \quad (3)$$

CD – Total cooling demand [MWh/year]

A – Gross building footprint area [m<sup>2</sup>]

NGR – Net area to gross surface area ratio [-]

H – Total height of the building [m]

H<sub>F</sub> – Floor height [m]

CD<sub>S</sub> – Specific cooling demand [kWh/m<sup>2</sup>/year]

Due to the lack of quality reliable data on cooling demand, the parameters involved in the bottom-up calculation have been calibrated and validated using national statistics on real estate areas and verifiable heat demand. This process includes the calibration of NGR and H<sub>F</sub> to the available data on surface areas of the specific building categories in the observed area as well as the calculated heating demand with the available aggregated heat demand data. As cooling is mostly provided through individual air-to-air heat pumps and cooling demand is rarely fully satisfied, there is no data available which the results of the calculations can be compared to. The cooling demand has thus been calculated for two climate conditions in the same area, an area with a high quantity of quality data, and the obtained results have been used to calculate a specific cooling demand per capita and per climate zone. This information has then been utilized to calculate the aggregated cooling demand for each individual municipality taking its climate zone into account.

### **2.1.2.3 Top-down cooling demand mapping**

The top-down cooling demand follows the same logic as the top-down heating demand mapping. The same publicly available data sources, namely the CORINE land cover maps [57], global population density map [58] and the Open Street maps service [59] have been utilized in the process in the same fashion as in the case of heat demand mapping. The combination of the modified CORINE land cover and population density maps have been used to distribute the calculated aggregated cooling demand on a municipal level onto a 1ha grid, taking the climate categories of each municipality into account, together with a set of weight factors. The result of this process is a cooling demand map with a resolution of 1 ha covering the entire observed



area. The weight factors used in the top-down method have been calibrated using the detailed bottom-up calculation for the reference location to minimize the overall error.

### **2.1.3 Implementation of the heating and cooling demand mapping methods**

The above-mentioned method has been applied on the cases of Croatia (aggregate heat demand calculation and top-down heating and cooling demand mapping) and the City of Zagreb (bottom-up heating and cooling demand mapping and reference cooling demand calculation). The City of Zagreb has been selected for the bottom-up mapping and as a reference for calibration and validation for two reasons: it holds close to 20% of Croatia's total population as well as roughly 23% of the total heat demand and the data for the implementation of these steps have been made available.

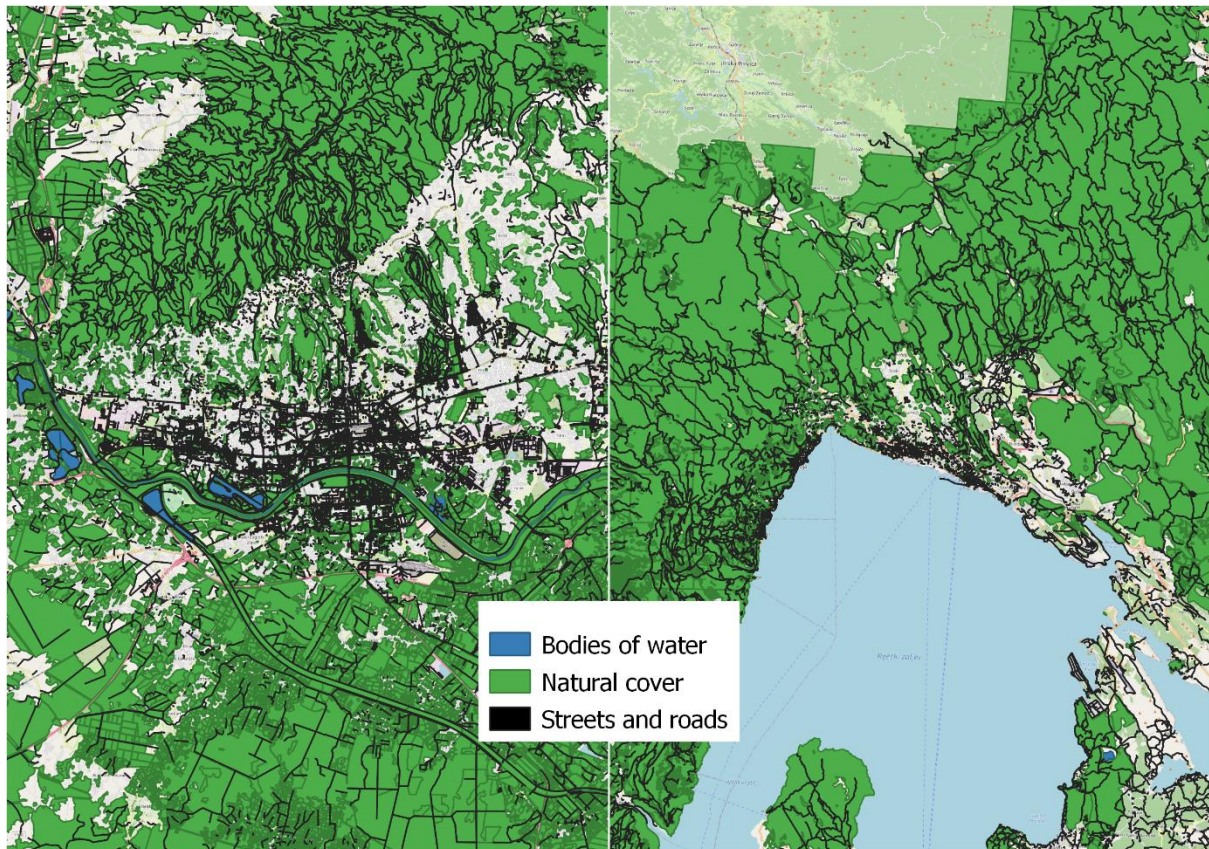
The aggregate heat demand of each municipality has been calculated using the Croatian census, official climate zone classification and the Long term strategy for the refurbishment of the building sector of Croatia [63]. Using these datasets, the surface areas per building type and climate zone as well as the aggregate heat demand per climate zone have been calculated. This data and the information on the population per climate zone as well as for each municipality, have been used to calculate the aggregate heat demand for each municipality.

The bottom-up map has been created using the cadastre of the City of Zagreb, its land use maps and LIDAR recordings, all provided by the Office for Spatial Planning of the City of Zagreb, City Office for the Strategic Planning and Development of the City of Zagreb, City Office for Cadastre and Geodetic activities of the City of Zagreb as well as the City of Zagreb itself. The cadastre maps were used to define the location and footprint areas of each building, the land use map data was added to this dataset to determine the use of each building and finally, the LIDAR was used to calculate each buildings height. An estimated average floor height and a gross to net surface area conversion factor have been used to calculate the net heated surface area of each building. These assumptions have been calibrated against the reference building shares of the residential, commercial and public categories for urban areas in Croatia [63]. The results of the calibration are presented in Table 1. As no information on the age of the buildings or their condition is available, such data could not be used in this research. Therefore, average specific heat demand data have been used for the 13 individual building categories.

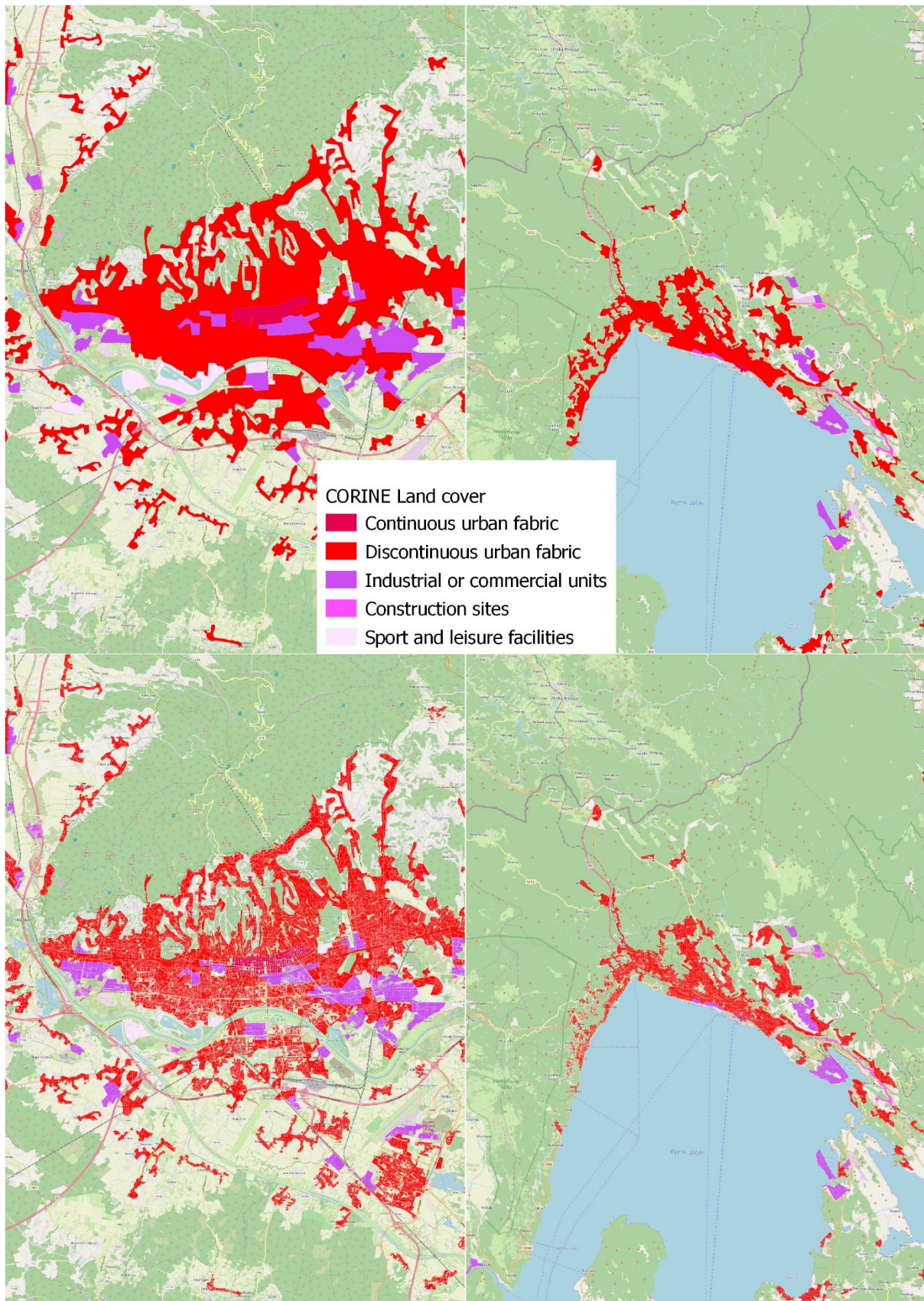
**Table 1 Reference aggregate and calculated bottom-up data for the city of Zagreb**

	Residential	Commercial	Public
Reference data [63]	67,14%	23,85%	9,01%
Bottom-up mapping	67,06%	23,77%	9,17%

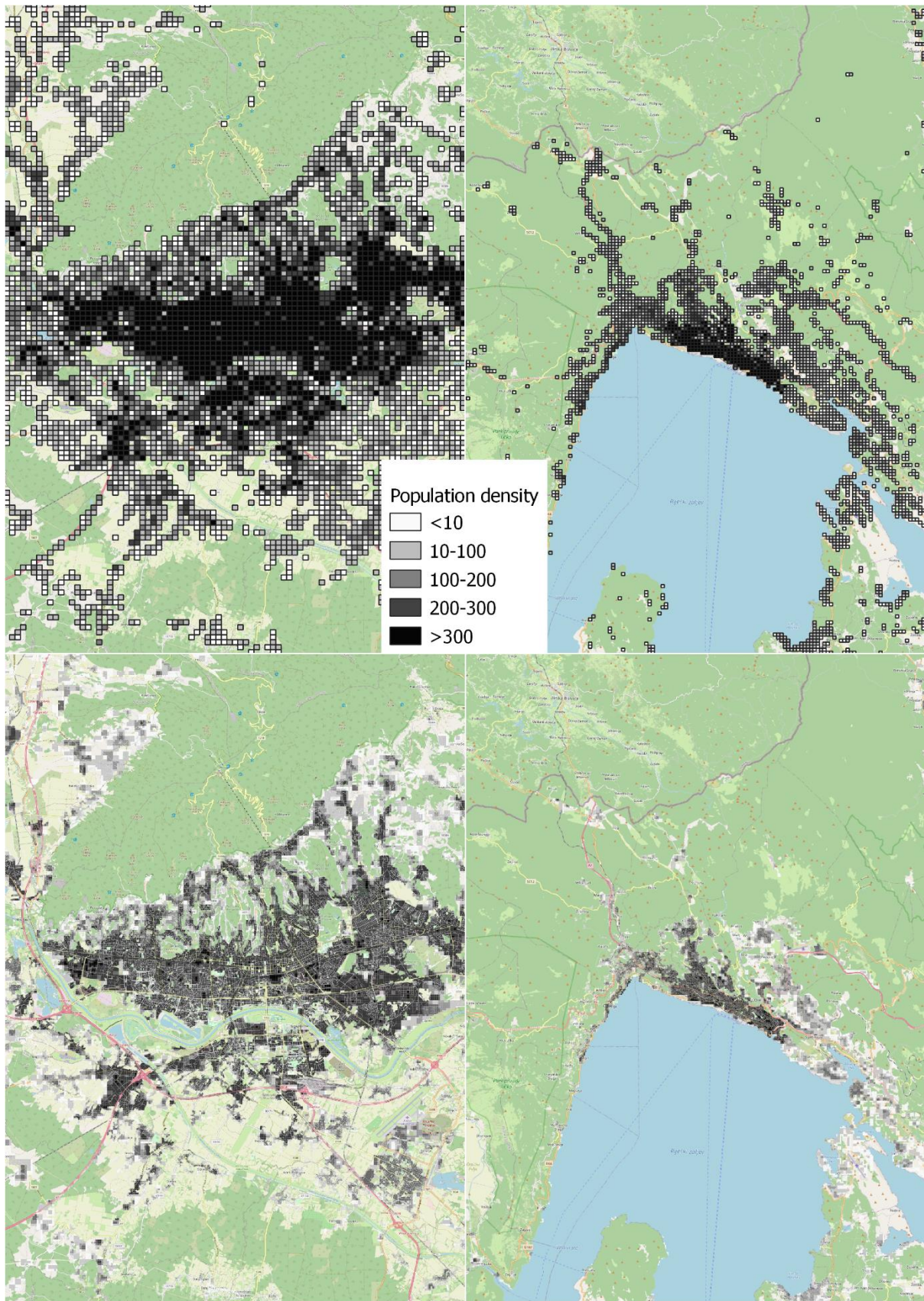
In order to move onto the top-down calculation, the data sets used for the spatial distributions of the aggregate values need to be prepared. Figure 1 presents the spatial distribution of roads [59], bodies of water [57] and natural areas [57], [59] used to modify the population distribution [58] and the CORINE land cover maps [57].



**Figure 1 Spatial distribution of roads, bodies of water and natural areas**



**Figure 2 CORINE land cover map; original data (up) and modified data (down)**



**Figure 3 population density map; original data (up) and modified data (down)**

Figure 2 and Figure 3 present the result of the modification of the CORINE land cover and population density maps. As it can be seen, the resulting maps have a much more varied distribution and a more realistic representation of the real-World situation. These modified maps and the determined weight factors have been used to distribute the aggregate heat demand of each municipality on a 1 ha grid. The weight factors were obtained through an iterative process where the absolute sum of all differences between the top-down and bottom-up heat demand maps was minimised using Equation (4).

$$\sum_{n=1}^{n=X} |HD_{nTD} - HD_{nBU}| = \min \quad (4)$$

n – number of compared cells [-]

HD<sub>nTD</sub> – heat demand of cell n calculated using the top-down method [MWh]

HD<sub>nBU</sub> – heat demand of cell n calculated using the bottom-up method [MWh]

The cooling demand mapping followed a similar logic, but the overall method had to be significantly adapted to the lack of data on actual energy consumption for cooling or cooling demand. As in the case of the heat demand mapping, the City of Zagreb has been used as a reference point and the area for bottom-up mapping while the top-down mapping has been implemented on the entire surface of Croatia.

The net cooled surface areas for the bottom-up mapping have been calculated using the exact same approach as in the case of the calculation of the net heated areas. Following that, the specific cooling demands of the individual building categories have been calculated both for Croatia's continental and coastal climates. The specific cooling demands and net cooled areas per building have then been used to calculate the final cooling demand for the City of Zagreb. Since Croatia has two distinct climate zones, both sets of specific cooling demands have been used thus creating a real (continental) and virtual (costal) cooling demand map for Zagreb. These data have then been used to calculate the specific cooling demands per population and climate zone. With this and the total population of each municipality, the total cooling demand has been calculated for each one.

Once the bottom-up cooling demand for the City of Zagreb and the aggregated cooling demands per municipality have been calculated, the top-down cooling demand maps have been created using the same approach as the one for the top-down heating demand.

All assumptions, weight factors and data used can be found in the attached papers [56] for heating and [64] for cooling.

## 2.2 Assessment of the potential for the utilization of DH and DC

The potential for the utilization of DH and DC depends on several technical and non-technical factors including but not limited to the existence of DH or DC grids and its operational parameters, availability of renewable or waste heat and free cooling sources, local prices of labour and equipment and so on. In order to provide a general assessment of the potential, this research has focused on the assessment of the needed margins between the price the heating or cooling energy can be sold for, and the cost incurred for its generation. The overall logic behind both the assessment of DH and DC is similar and can be used interchangeably. The potential for the utilization of DH as presented in [56] is calculated using Equation (5) while the potential for the utilization of DC as presented in [64] is calculated using Equation (6).

$$(HP - LCOH) \cdot HD - C_g = 0 \quad (5)$$

(HP-LCOH) – Difference between the average heat price and the levelized cost of heat [EUR/MWh]

$C_g$  – Average cost of grid per observed square [EUR]

HD – Heat demand [MWh/year]

$$(CP - LCOC) \cdot CD_{1km} - L_{g1km} \cdot C_{Cg} = 0 \quad (6)$$

(CP-LCOC) – Difference between the price and the levelized cost of cooling [EUR/MWh]

$CD_{1km}$  – Cooling demand in a 1km radius [MWh/year]

$L_{g1km}$  – Length of the cooling grid in a 1km radius [m]

$C_{Cg}$  – Specific cost of the cooling grid [EUR/year/m]

The HP-LCOH and CP-LCOC values are determined for each observed grid segment for which the result of the above presented equations equal 0. This provides the minimum difference between the average price at which the heating or cooling energy is sold at and the levelized cost of production for which the implementation of DH or DC is economically justified.

In the case of the DH assessment, the grid cost,  $C_g$  represents the annual cost of the grid's installation (annual depreciation with a time frame of either its lifetime or the project funding duration) and its operation and maintenance. This way, it can be assumed that no grid exists. Since the specific grid cost depends greatly on the type of terrain, heat demand and available as well as necessary routes the grid can or must take, it is difficult or in some cases impossible to determine an accurate figure. For this purpose, several cost levels can be chosen, and results can be presented for each, demonstrating the sensitivity of the assessments as well as presenting different results for different segments of the assessed areas. In cases where a specific cost can be determined with a high degree of accuracy, it can and should be used.

In the case of the DC assessment, the length of the roads and streets in the individual grid squares, taken from the Open Street maps service, have been used as a proxy for the length of the necessary cooling grid. The lengths have been aggregated from a distance of 1 km from the centre point of the individual grid square. Finally, in order to determine the cost of the grid per each observed square, the aggregated length has been multiplied by an annual grid cost which includes maintenance and the depreciation of the investment cost.

As stated above, both approaches can be utilized in both cases, depending on the availability of data and the assumptions being used.

### **2.3 Assessment of the impact of DH and DC on the potential for the utilization of intermittent renewable electricity generation**

As the need for clean, renewable energy rises, solar and wind play increasingly important roles in Europe's energy systems. Their utilization in turn requires increasing energy storage and flexibility options to cope with their inherent intermittency. DHC systems, alongside the potential for the decarbonization of the heating and cooling sectors, can provide flexibility services using power to heat technologies and heat storage systems. In practice, this means that when excess electricity is generated by intermittent sources, it can be transformed into heat via electric boilers or heat pumps and either used or stored. These systems can also be turned off when a lack of electricity occurs, and stored heat can be used to satisfy the heating demand.

Finally, if CHP plants are used, they can be turned on to generate electricity even when no heat is needed as it can again be stored easier and cheaper than electricity. The utilization of DC together to generate and even store cooling energy can further enhance these capacities due to the introduction of a higher energy demand overall and especially in warmer periods of the year when DH operates at lower capacities. This added flexibility allows for more intermittent energy sources to be added into an energy system while keeping CEEP at an acceptable level.

For the purpose of this research, the H2RES model has been used to assess the potentials of DH and DHC to reduce CEEP in systems with a high share of wind and solar energy.

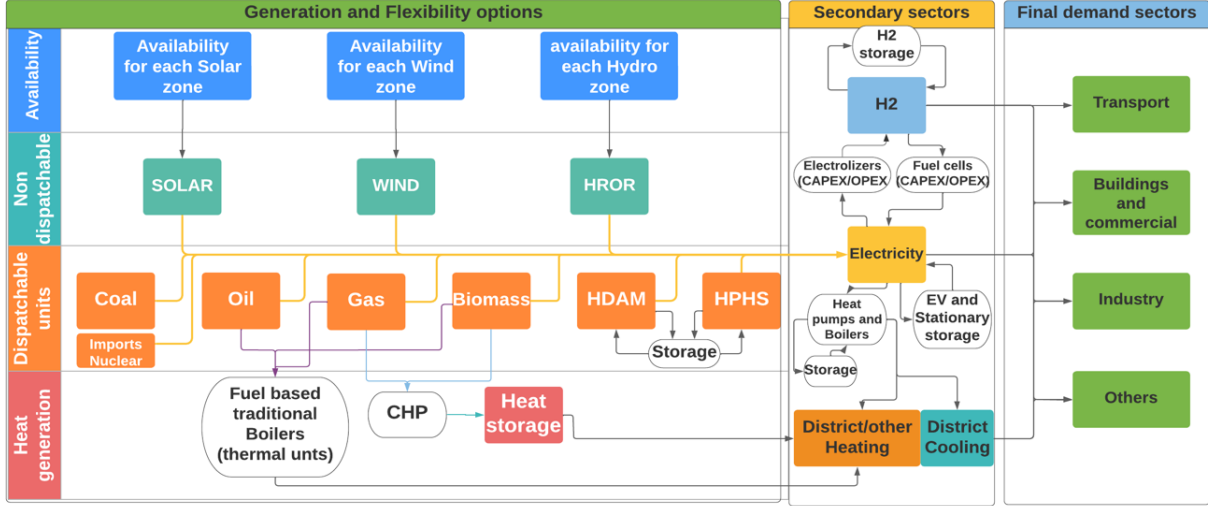
### **2.3.1 The H2RES model**

The H2RES model [65] is a  $\phi$  with an hourly resolution scale. H2RES is particularly developed to model and analyse the penetration of variable RES in an energy system as well as sectoral coupling via Power-to-X technologies. Hence, H2RES enables the analysis of decarbonization strategies among the power, heating and cooling, transport, and industry sectors using Power-to-Heat, Power-to-EV, Power-to-Power, and Power-to-hydrogen technologies. The optimization performed minimizes the total cost incurred in supplying all energy demands, including variable, capital, and policy costs. Figure 4 presents a general representation of the H2RES model. H2RES is built in Python and is solved using the GUROBI solver for linear optimization models.

H2RES considers three main sets of decisions. First, it models the yearly capacity of investments for all technologies (e.g., power plant or H2 storage capacity). It then considers that when a capacity addition is made for a given technology, this addition becomes available at the beginning of each modelled year. Also, H2RES follows this capacity over the planning years and performs a decommission (percentage of the capacity added) based on decommission curves predefined by the users. Secondly, given the capacity investment plans, it models the dispatch for all technologies. Dispatch of the technologies is considered at an hourly resolution for every year of the planning horizon. The hourly resolution allows the user to better represent the relation between variable RES and Power-to-X technologies. The dispatch of each technology is also subject to the initial capacity, capacity investments, availability factors (for variable sources) and decommission of each individual technology. The third set of decisions for H2RES corresponds to storage levels (hydro-dam, heat, H2, EV, and stationary batteries). Storage levels for each unit or technology, when available, are also represented with an hourly



resolution for every year considered in the planning horizon and are subject to maximum storage levels, defined by initial capacities, future investment, and decommission curves.



**Figure 4: Representation of the H2RES model**

Investments, dispatch, and storage level decisions in H2RES are made with the main objective of minimizing total annual discounted cost over the planning horizon (see Equation (7)) subject to a set of constraints. The cost minimization components are variable dispatch cost, capital investment, ramp up and down costs, energy import costs, emissions costs, energy transformation cost (e.g., cost of electrolysers) and the cost associated to CEEP. Additional constraints such as maximum emission levels can also be introduced. Note that H2RES allows the setting of limits on both CO<sub>2</sub> emissions and CEEP levels, while it also allows the user to assign costs to these parameters. Therefore, H2RES is designed to assess scenarios in which both CO<sub>2</sub> and CEEP levels are either penalized or limited by the users.

$$\sum_y \sum_p \sum_t df_y [C_{t,p,y} D_{t,p,y} + TC_{t,y} K_t Inv_{t,y} + R_{t,p,y} Ramp_{t,p,y} + I_{p,y} Imp_{p,y} + CO_2 Price_y CO_2 Levels_{t,p,y} + CEEP\_cost CEEP_{t,p,y} + HSk_t Hsto_{t,y}] \quad (7)$$

The component  $C_{t,p,y} D_{t,p,y}$  in the objective function (Equation (7)) represents the variable cost ( $C_{t,p,y}$ ) incurred by dispatching ( $D_{t,p,y}$ ) a given technology (t), in a period or hour (p), and in year (y). The variable cost,  $C_{t,p,y}$  (see Equation (8)), considers the fuel cost and non-fuel cost,

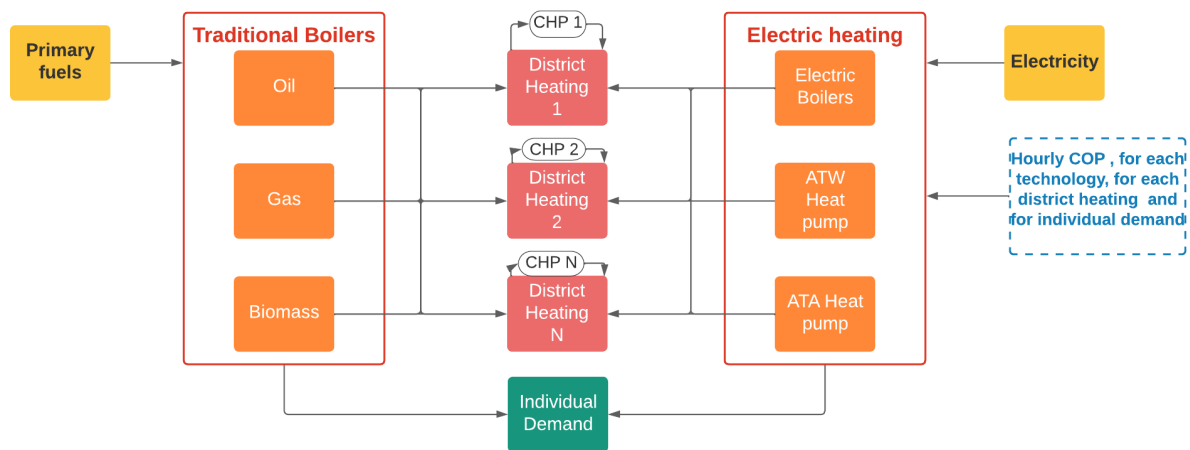
allowing the model to account for different cost structures for distinct types of technologies. This component is general across all technologies in H2RES, including the dispatch cost of power and DHC technologies (e.g., electric boilers or heat-pumps). Similarly, the component  $TC_{t,y}K_tInv_{t,y}$  represents the cost (K and TC) incurred by commissioning a given technology (power, heating or cooling). The unit costs are separated into a fixed value across the duration of the entire scenario (K) and a variable section dependent on annual cost curves (TC). The last term  $HSk_tHsto_{t,y}$  represents the capital investment cost (Hsk) for heat storage (Hsto) in district heating networks.

$$C_{t,p,y} = \left[ \frac{FuelCost_{t,p,y}}{eff_{t,p,y}} + NonFuelCost_{t,p,y} \right] \quad (8)$$

Although the version of H2RES used in this research does not consider network flows (trade) among different regions (rather, it considers a national system), the model considers different heat and cooling demand curves for different zones within the system (see Table 2 for further details on input data and curves). Similarly, H2RES has the possibility to including the necessary number of wind and solar production zones within the national planning system. In this way, H2RES provides the option to assess the role of areas or regions with high or low capacity factors (assuming that transmission infrastructure is always available) with different availability profiles. Similarly, adding different demand zones (heat and cooling), each represented by an individual hourly profile (demand curves are exogenous and defined in the input data) allows the user to assess the electrification or decarbonization of heating and cooling systems with different characteristics (availability of DH, DC and DHC, availability of power-to-heat technologies, and integration of RES with different demand profiles). Also, the introduction of different zones allows the consideration of different COP (coefficient of performance) as well as other efficiencies and losses associated to heat-pump technologies, influencing their ability to provide heat and cooling energy over seasons and day-night periods. Further details of the heat and cooling sectors in H2RES are described below.

H2RES differentiates between DH and individual heating demands. Both demand types can be supplied by a set of technologies, including traditional fuel boilers (coal, gas, biomass boilers), electric boilers, and different heat-pump technologies. Each of these technologies is defined by a set of technical characteristics, including variable costs, efficiencies, COP, and lifetimes, among others. In the case of DH demand, CHP plants are available. H2RES assumes that each

CHP plant is supplied with heat storage that can be optimized (size and usage of heat storage). It also models losses in heat storage, input, output and losses among the time periods of the scenario, and in energy transformation processes. Additionally, H2RES allows the use of power to heat technologies through the introduction of Electric Boilers and Heat-pumps as well as heat storage. Additionally, there is no limit in terms of how many DH systems can be modelled with H2RES. Note that DH system are by default connected to CHP plants, however, if no CHP plant is to be considered, the capacity of such can be set to zero, removing this option from the system. A depiction of the heat sector in H2RES is shown in Figure 5.



**Figure 5: Representation of the Heating sector in H2RES**

For the purpose of this research, individual cooling demand and DC systems were developed and incorporated into the base module of H2RES. DC follows a similar modelling paradigm as DH. H2RES considers different cooling demand profiles for different systems (representing different regions, cities, or areas with independent cooling demands). It is assumed that heat-pump technologies are available to meet cooling demand. Note that such heat-pump technologies, if installed, also provide heat when heat demand in a connected DH systems is present. Therefore, H2RES optimizes the size (capacity) and usage of heat-pumps during both heating and cooling seasons with the goal of minimizing total costs while considering the technical characteristics of the different technologies (variable cost, losses, efficiencies, COPs, others). Finally, as any technology in H2RES, heat pumps are also subject to decommission. Therefore, if a long-term planning scenario is analysed, heat-pump for cooling systems can be replaced for cheaper and more efficient technologies in future periods. It is important to note that H2RES can model any technology for which the user can supply the needed inputs which

include the investment and other costs, efficiencies, ramp-up and down speeds and limits to the installed capacities.

**Table 2: Main input data files in H2RES**

<b>Demand file</b>	<b>Definition/Parameter</b>	<b>Notes</b>
<b>Demand data</b>	Electricity demand per demand sector	Hourly electricity demand profile for each year in MWh
<b>Heat demand data</b>	General demand	Hourly individual heat demand profile for each year in MWh
	Industry demand	Hourly industry heat demand profile for each year in MWh
	DH demand	Hourly DH demand profile per DH network for each year in MWh
<b>Cooling demand data</b>	DC zones	Hourly DC demand profile per DC network for each year in MWh
	General demand	Hourly individual cooling demand for each year in MWh
<b>H2 demand data</b>	Hydrogen demand per demand sector	Hydrogen demand for each period and year in MWh
<b>Fuel price data</b>	Fuel price	Variable (fuel) price of fuel for each of the fuels considered in H2RES.
<b>Availability factors</b>	availability factor	Availability factor for all non-dispatchable zones, including wind, solar and HROR zones
<b>Inflow data</b>	Water inflows	Water inflows (scaled to capacity) for each of the HDAM and HPHS units defined in the power generator data files.

<b>Import-export</b>	Import and export net transfer capacity	Imports net transfer capacity (MWh) are always required.
----------------------	---	--

The full details of the H2RES model and the approach used for this research can be found in [66].

### 2.3.2 Scenario creation and implementation of the H2RES model

As with the heating and cooling demand mapping, the Republic of Croatia has been used as a case study for this research. Even though H2RES supports multi-year scenarios, this research focuses on single-year scenarios meaning that some aspects of its functionalities, for instance decommission, are not utilized.

#### 2.3.2.1 Scope of the case study

The case study has considered the total electricity demand of the Republic of Croatia as stated in [67]. The heating and cooling demands of 9 cities have been considered for the modelling of DH and DC demands, out of the 556 cities and municipalities in Croatia. The cities have been selected based on their location and size (6 largest continental/mild and 3 largest costal/Mediterranean climate cities) and the consideration if they already have a DH system (8 of the 9 cities have a DH system of some scale). There are currently no DC systems present in Croatia which also means that there are none in the 9 selected cities. Table 3 presents the scope of the case study. The 9 selected cities represent 37% of the total Croatian heating and 34% of the total Croatian cooling demand. The heating demands have been taken from [56] and cooling demands have been taken from [64].

**Table 3 Scope of the case study**

<b>City</b>	<b>Heating demand MWh</b>	<b>Cooling demand MWh</b>	<b>Location</b>	<b>DH</b>
<b>Zagreb</b>	8.257.006,82	2.121.063,25	Continental	Yes
<b>Osijek</b>	1.091.397,66	290.098,76	Continental	Yes
<b>Split</b>	928.099,75	606.437,04	Costal	Yes
<b>Velika Gorica</b>	655.852,50	170.538,14	Continental	Yes

<b>Rijeka</b>	653.951,94	437.963,20	Costal	Yes
<b>Slavonski Brod</b>	584.941,17	158.793,92	Continental	Yes
<b>Karlovac</b>	547.486,55	149.557,51	Continental	Yes
<b>Sisak</b>	464.509,38	128.251,98	Continental	Yes
<b>Zadar</b>	403.957,07	255.586,36	Costal	No
<b>Total</b>	13.587.202,83	4.318.290,16		
<b>Croatia</b>	36.288.855,02	12.521.269,96		
<b>Coverage</b>	37%	34%		

### 2.3.2.2 Demand and supply distributions

The hourly electricity demand for Croatia has been taken from [67]. The hourly space heating demand has been modelled for two climate zones, Continental based on the City of Zagreb and Coastal based on the City of Split using a degree hour analysis which resulted in two unit curves. The hourly domestic hot water demand has been taken from [68]. The final unit heating demands have been calculated using an 18% share of hot water demand against space heating demand for the Continental and 30% for the Coastal climates. The Continental share has been taken from real data available in the City of Zagreb while the Coastal share has been assumed considering the difference in overall heating degree days between Zagreb and Split. The hourly cooling demand distributions have been created as a combination of space cooling and baseline cooling demands and again for the same two climate zones based on Zagreb and Split. The baseline cooling demand has been created using the first week of the Gothenburg hourly DC demand distribution available in the EnergyPLAN model [69]. The space cooling demand has again been calculated as a degree hour analysis for two climate tones again represented by the City of Zagreb (continental) and City of Split (Costal). The final distribution has been created with an assumed share of the baseline demand of 60% in the Continental and 40% in the Coastal climates as no data is available for Croatia.

The hourly supply distributions include the hourly electricity production from wind and solar and they have been taken from [70].

### **2.3.2.3 Technical and economic parameters**

The following technical parameters have been used as inputs for the model:

1. Photovoltaics
  - a. Hourly availability factor (0 – 1)
2. Wind powerplants
  - a. Hourly availability factor (0 – 1)
3. CHP
  - a. Electrical efficiency: 0,306
  - b. Thermal efficiency: 0,647
  - c. Power loss factor: 0,18
4. Heat pumps
  - a. Heating COP: hourly model from [67]
  - b. Cooling COP: hourly model from [67]
5. Heat storage:
  - a. Storage self-discharge rate: 0,04

The investment costs for the technologies have been taken from [71]. Additionally, the system cost of CEEP has been set to 4.000 EUR/MWh

### **2.3.2.4 Scenario creation**

To isolate and highlight the impact DH and the combination of DHC has on the potential for the utilization of intermittent RES, two lines of scenarios have been developed:

1. DH with renewable electricity generation;
2. DHC with renewable electricity generation.

Renewable electricity generation in all scenarios means a combination of wind and PV in four intervals, namely steps of 2.000, 4.000, 6.000 and 8.000 MW of both wind and PV (for example in the 2.000 MW scenario this means 2.000 MW of wind and 2.000 MW of PV power simultaneously). These installed capacities and with that the hourly production of electricity from intermittent renewable sources have been used consistently across all scenarios. No additional electricity sources outside of the ones connected to the DHC systems have been permitted.

The energy systems in the scenarios with DH were permitted to utilize CHP, heat pumps, electric boilers and heat storage in order to satisfy the heating demand. In the scenarios with cooling, heat pumps were the only allowed source of cooling.

This has resulted in the development of the following 7 scenarios presented in Table 4.

**Table 4 List of the developed scenarios**

<b>Scenario</b>	<b>Description</b>
<b>REF</b>	Reference scenario with no DH or DC
<b>H1</b>	DH share of 30% of total heat demand
<b>H2</b>	DH share of 50% of total heat demand
<b>H3</b>	DH share of 90% of total heat demand
<b>HC1</b>	DH share of 30% of total heat and DC share of 10% of total cooling demand
<b>HC2</b>	DH share of 50% of total heat and DC share of 30% of total cooling demand
<b>HC3</b>	DH share of 90% of total heat and DC share of 50% of total cooling demand

Additionally, each scenario except REF has been tested with two limits to the use of electric boiler as a source of heating and power to heat capacities. For this purpose, two sub-scenarios have been created for the 6 scenarios with limits set to 600 MW and 2.500 MW of electric boilers.

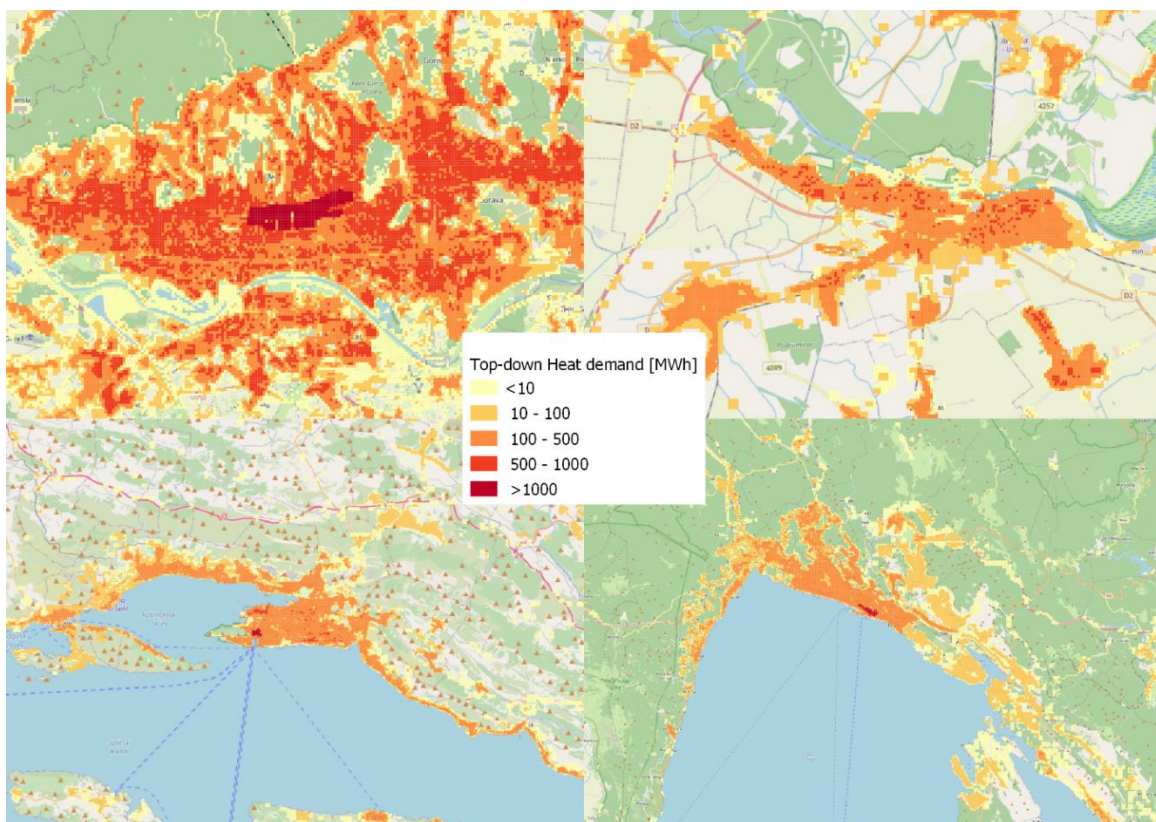
In all six scenarios with DH and/or DC, the heat capacity of the CHP units has been set to match the peek heat demand in the individual systems so that the power to heat units can be optimized to the electricity demand and not the heat demand.



# 3 SELECTED RESULTS AND DISCUSSION

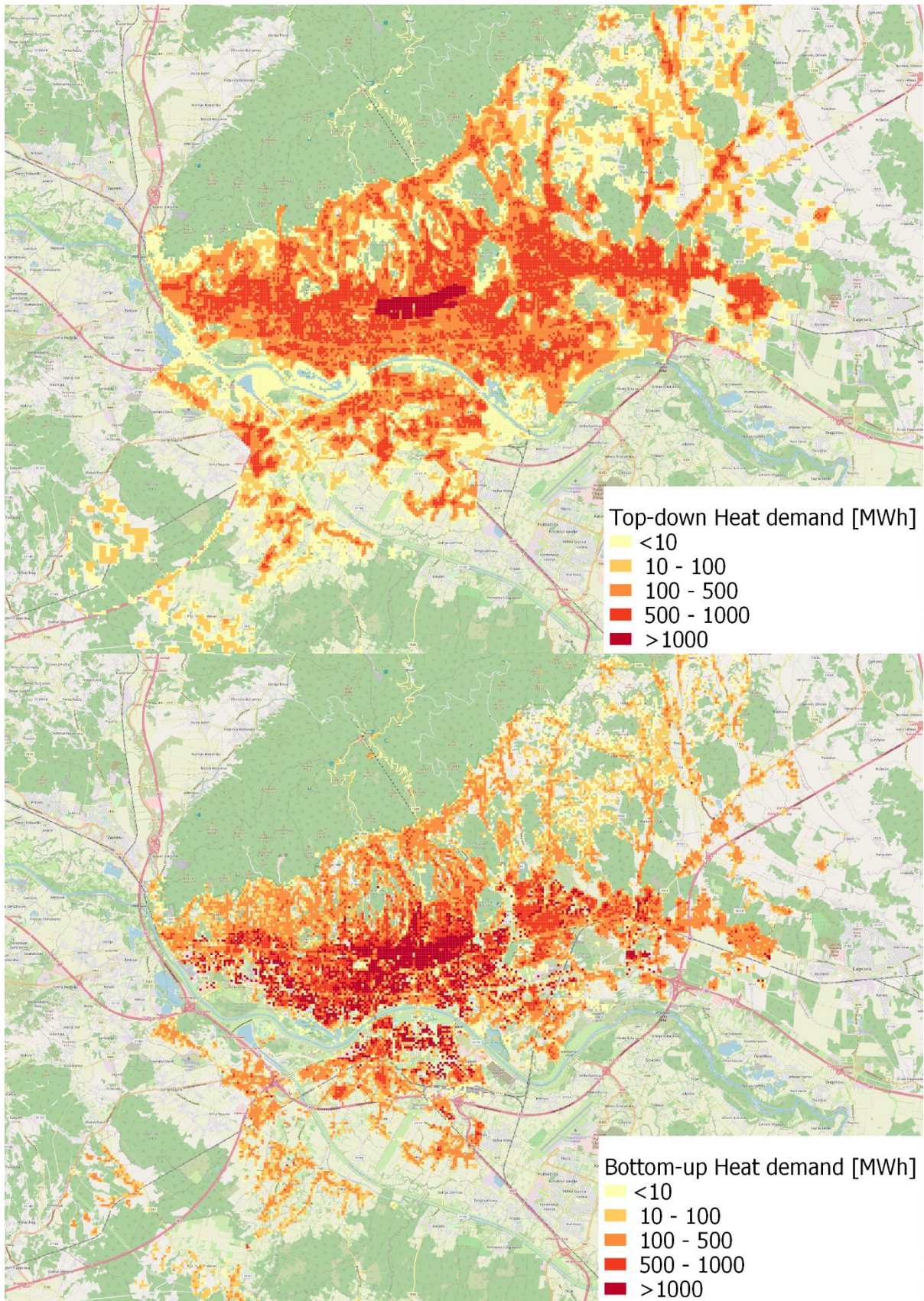
## 3.1 Bottom-up and top-down heating and cooling demand

Figure 6 presents an example of the results of the top-down mapping of Croatia's heat demand with a resolution of 1 ha and Figure 7 shows the comparison of the bottom-up (above) and top-down (below) heat demand mapping for the city of Zagreb.



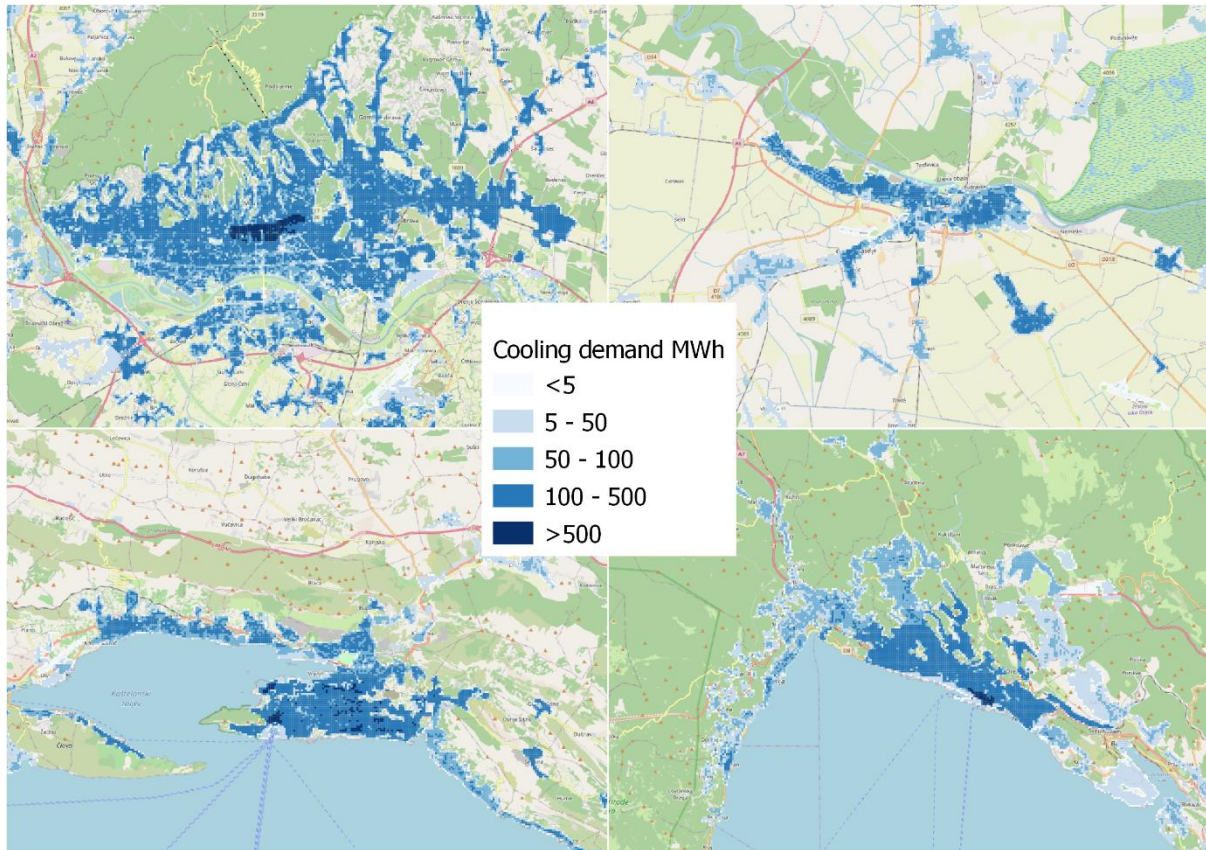
**Figure 6 Final Top-down heating demand map (Top left: Zagreb, Top right: Osijek, Bottom left: Split, Bottom right: Rijeka)**

As Figure 7 shows, the heat demand matches up visually for the two cases. It can be observed that the bottom-up map has larger densities of demand distributed over a smaller area when compared to the top-down map. This is expected since the bottom-up mapping utilizes the actual distribution of the built-up areas based on individual buildings whereas the top-down one relies on the distribution based on a fixed resolution. The removal of roads, bodies of water and natural areas does bring these distributions closer to one another.



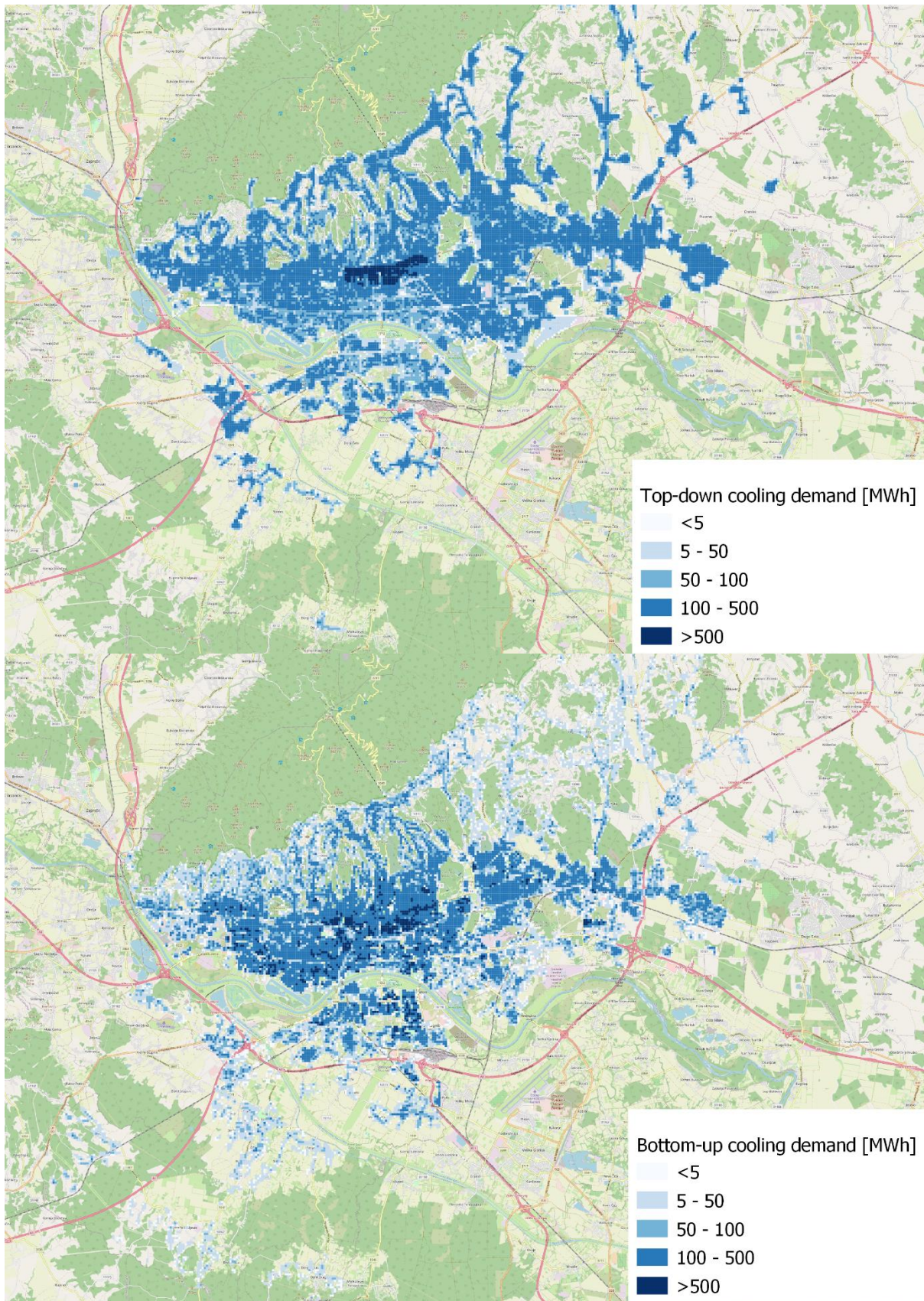
**Figure 7 Comparison of the top-down (top) and bottom-up (bottom) heating demand maps for the City of Zagreb**

Figure 8 presents the top-down cooling demand map for several locations within the case study while Figure 9 present the comparison between the top-down and bottom-up cooling demand mapping for the City of Zagreb.



**Figure 8 Final Top-down cooling demand map (Top left: Zagreb, Top right: Osijek, Bottom left: Split, Bottom right: Rijeka)**

Similarly to the heat demand mapping, it is again evident that the bottom-up map provides a more diverse distribution of the demand as seen from a less uniform distribution compared to the top-down. This is expected due to the diversity of the specific cooling demands for the various building categories as well as from the relatively flat distributions of the land use and population densities. Despite that, the top-down map has identified the locations of the cooling demand as well as the critical hotspots which should be investigated further.

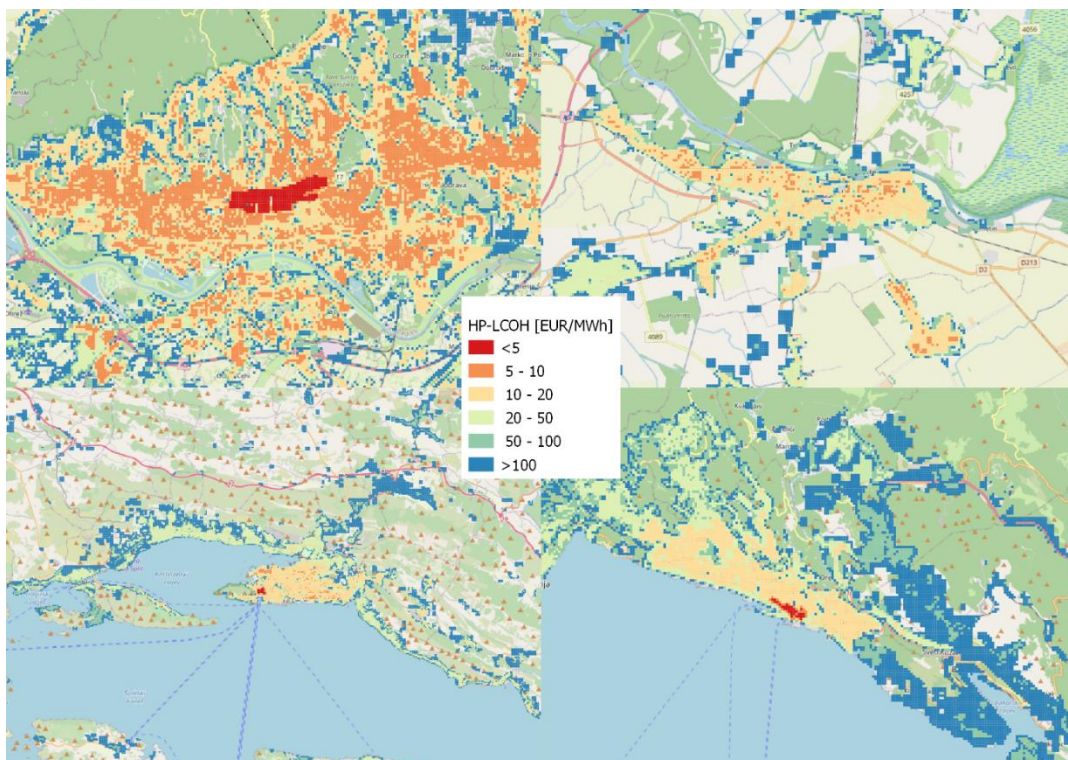


**Figure 9 Comparison of the top-down (top) and bottom-up (bottom) cooling demand maps for the City of Zagreb**

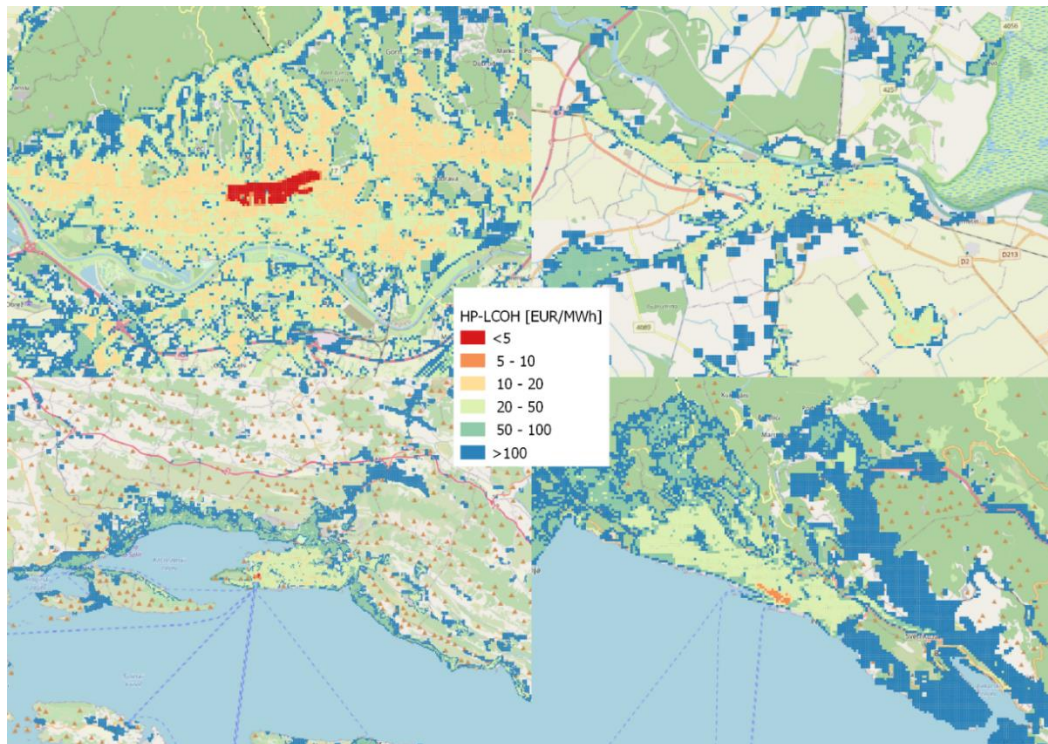
### 3.2 District heating and cooling potential

Figure 10, Figure 11 and Figure 12 present the results of the DH potential analysis for three selected annual grid costs (5.000, 10.000 and 15.000 EUR/ha) at a resolution of 1 ha. It can be observed that the assumed grid costs do have a significant impact on the end results, as was expected.

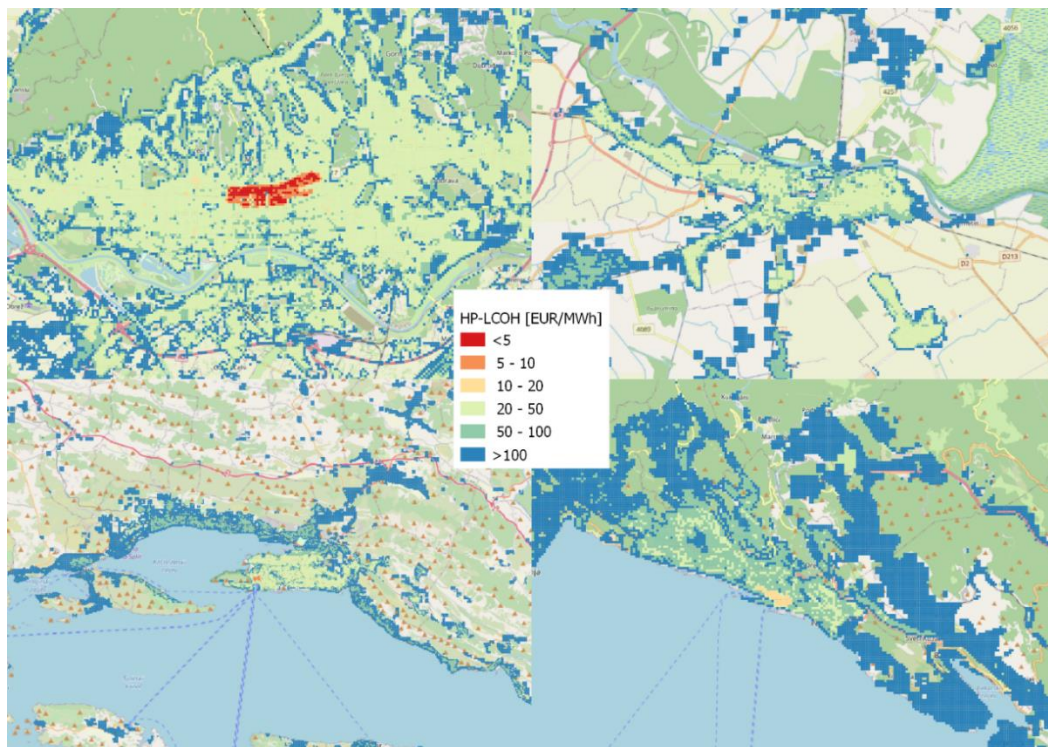
The figures present the assessment of the potential for two continental cities on the top (Zagreb to the left and Osijek to the right) and two coastal cities on the bottom (Split on the left and Rijeka on the right). This view also presents a split between the continental (top) and Mediterranean (bottom) climates. It is evident from the presented figures that the continental cities do have more locations with a higher density of heat demand, especially the City of Zagreb, which is also Croatia's largest city, however high density hot-spots can also be observed in the two coastal ones as well. Additionally, it is evident from the presented figures that a significant amount of heat demand is present and, depending on the grid costs, can be exploited at moderately high heat prices without incurring losses. It is also important to note that in cases when DHW is not supplied via a DH system, its overall viability decreases greatly.



**Figure 10 District heating potential with grid cost of 5.000 EUR/ha (Top left: Zagreb, Top right: Osijek, Bottom left: Split, Bottom right: Rijeka)**



**Figure 11 District heating potential with grid cost of 10.000 EUR/ha (Top left: Zagreb, Top right: Osijek, Bottom left: Split, Bottom right: Rijeka)**



**Figure 12 District heating potential with grid cost of 15.000 EUR/ha (Top left: Zagreb, Top right: Osijek, Bottom left: Rijeka, Bottom right: Split)**

Table 5 shows the comparison of the DH potential analysis for the bottom-up and top-down heat demand mapping for the City of Zagreb with the three different grid costs. The values in the table present which percentage of the heat demand falls below the HP-LCOH price level. This for example means that in the case of the 5.000 EUR/ha grid cost, 88% of the heat demand of the city can be economically covered through DH if the average price of heat is 20 EUR/MWh above the LCOH for the bottom-up mapping method. The same result would be 90% in the case of top-down mapping. In case of the 10.000 EUR/ha grid cost and the same heat price level, the results are 75% for the bottom-up and 55% for the top-down mapping method. The table also shows a consistent underestimation of the potential for the top-down mapping when compared with bottom-up at lower prices. These differences are smaller for lower grid costs and larger for the higher ones. It can therefore be concluded that the results of the top-down mapping can be considered as conservative.

**Table 5 District heating potential for the City of Zagreb at a resolution of 1ha**

Price EUR	5 kEUR		10 kEUR		15 kEUR	
	Bottom-up	Top-down	Bottom-up	Top-down	Bottom-up	Top-down
<5	52%	11%	30%	10%	16%	6%
<10	74%	55%	52%	11%	40%	11%
<15	84%	84%	66%	13%	52%	11%
<20	88%	90%	74%	55%	62%	12%
<25	91%	93%	80%	77%	69%	24%
<30	93%	95%	84%	84%	74%	55%
<35	94%	95%	86%	88%	78%	72%
<40	95%	96%	88%	90%	81%	80%
<45	96%	96%	90%	92%	84%	84%
<50	97%	96%	91%	93%	86%	86%

<55	97%	97%	92%	94%	87%	89%
<60	97%	97%	93%	95%	88%	90%
<65	98%	98%	94%	95%	90%	91%
<70	98%	98%	94%	95%	90%	92%
<75	98%	98%	95%	95%	91%	93%
<80	98%	98%	95%	96%	92%	94%
<85	98%	98%	96%	96%	93%	95%
<90	99%	98%	96%	96%	93%	95%
<95	99%	98%	96%	96%	94%	95%
<100	99%	98%	97%	96%	94%	95%

Table 6 presents the results of the DH potential assessment based on the top-down heat demand map of Croatia on the same 1 ha raster. It can, for example, be observed that at a HP-LCOH (Price EUR in the table) level of 30 EUR/MWh, 61% of the total heat could be economically supplied through DH if the network cost is 5.000 EUR/ha annually on average. This level drops to 31% and 16% for grid costs of 10.000 and 15.000 EUR/ha.

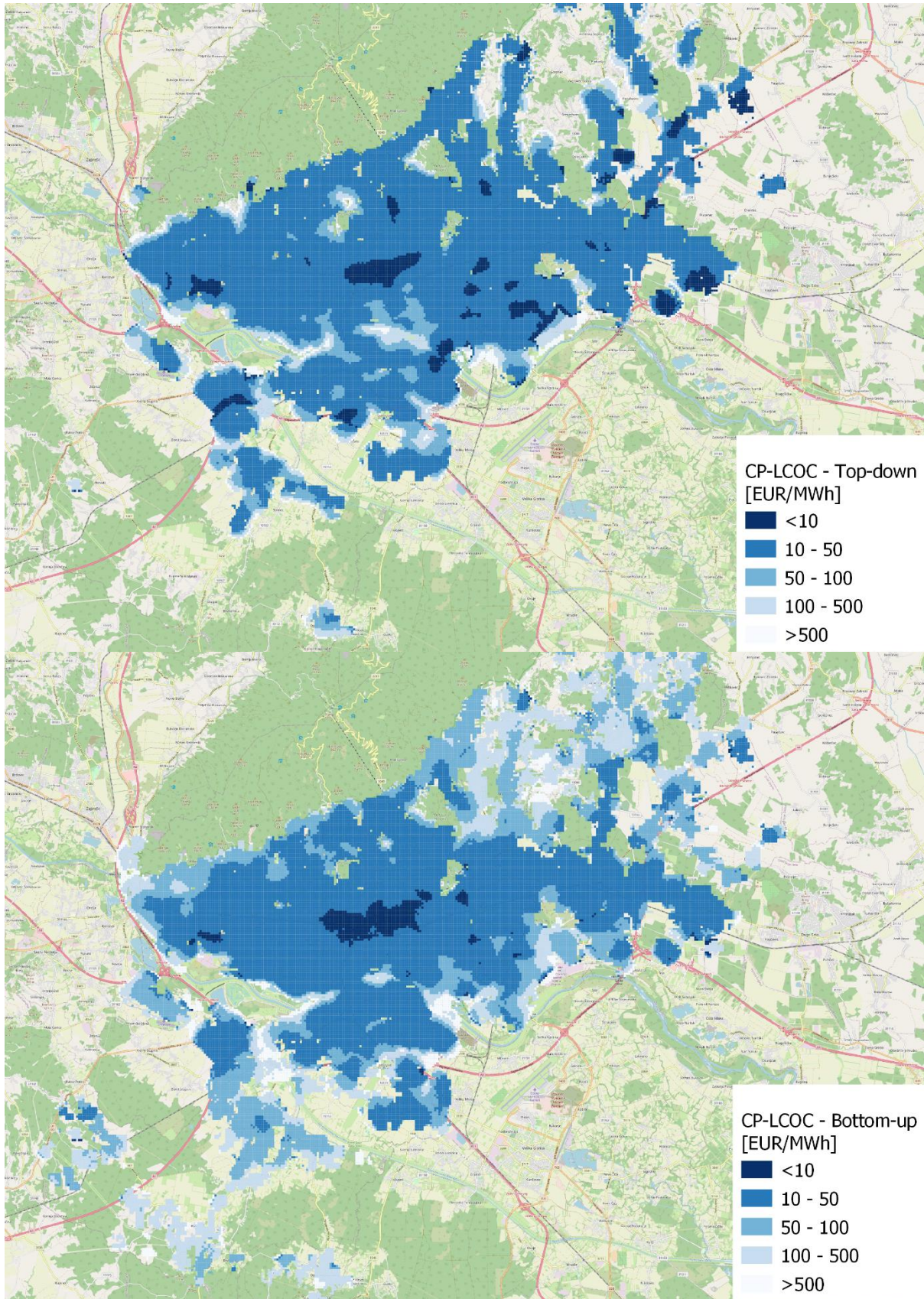
**Table 6 District heating potential for Croatia at a resolution of 1ha**

Price EUR	5 kEUR	10 kEUR	15 kEUR
<5	3%	2%	1%
<10	16%	3%	3%
<15	31%	4%	3%
<20	44%	16%	4%
<25	54%	25%	7%
<30	61%	31%	16%



<35	67%	38%	22%
<40	71%	44%	27%
<45	75%	49%	31%
<50	77%	54%	36%
<55	79%	58%	40%
<60	81%	61%	44%
<65	82%	64%	48%
<70	84%	67%	51%
<75	84%	69%	54%
<80	85%	71%	57%
<85	86%	73%	59%
<90	87%	75%	61%
<95	87%	76%	63%
<100	88%	77%	65%

A similar assessment has been conducted for the potential for the utilization of DC as well. Figure 13 presents the CP-LCOC values calculated using the Top-down (top) and Bottom-up (bottom) methods assuming the cost of the cooling network at 500 EUR/m. The values, similarly to the DH assessment, represent the margin, or the difference in the price of cooling compared to the levelized cost of cooling, needed for the system to be viable. Darker colours in the figure present locations in which district cooling is more viable. Some differences can again be spotted, however the main trends have been captured well as the primary hot spot for DC potential are identified in similar locations (the city centre with the highest density of buildings and population).



**Figure 13 Comparison of the viability of district cooling for the City of Zagreb (Top: Top-down, Bottom: Bottom-up)**

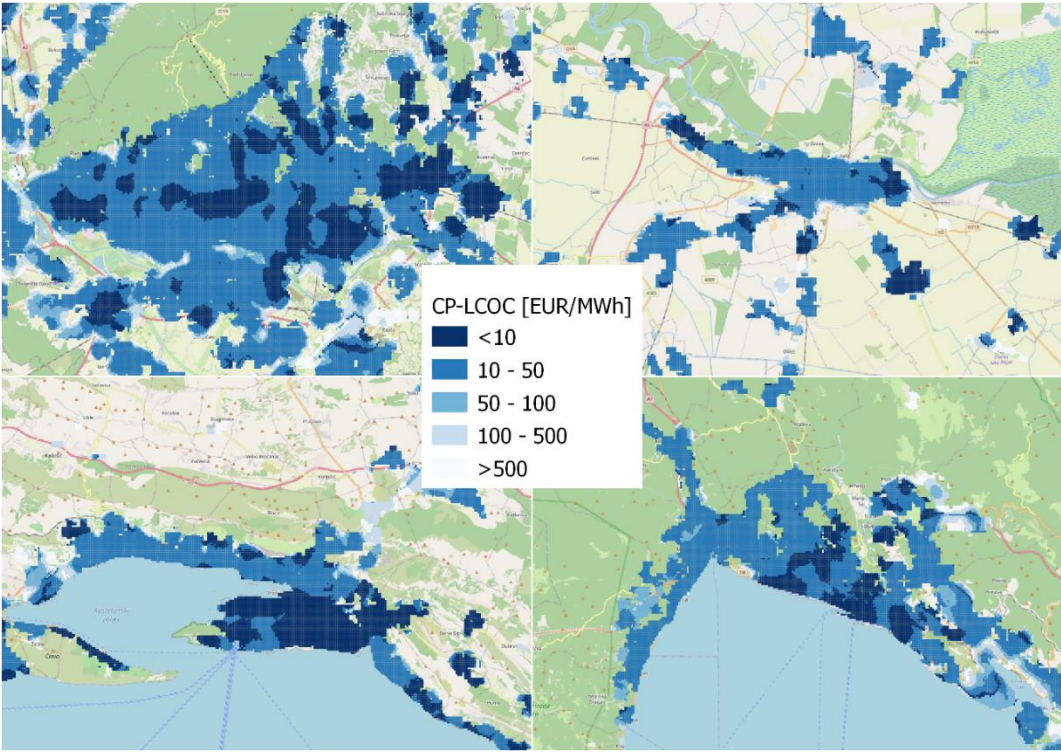
Table 7 presents the results of the sensitivity analysis as well as a comparison of the bottom-up and top-down mapping results. As expected, higher grid costs greatly reduce the viability of DC. For example, at a CP-LCOC level of 20 EUR/MWh, 72,10% of the total cooling demand in the City of Zagreb could be covered with district cooling if the grid cost equals 250 EUR/m. This goes down to 34,11%, 16,98% and 10,21% in the cases when the grid cost is increased to 500, 750 and 1.000 EUR/m respectively.

**Table 7 Sensitivity assessment off the viability of district cooling to the cost of the cooling network – Bottom-up and Top-down results for the City of Zagreb**

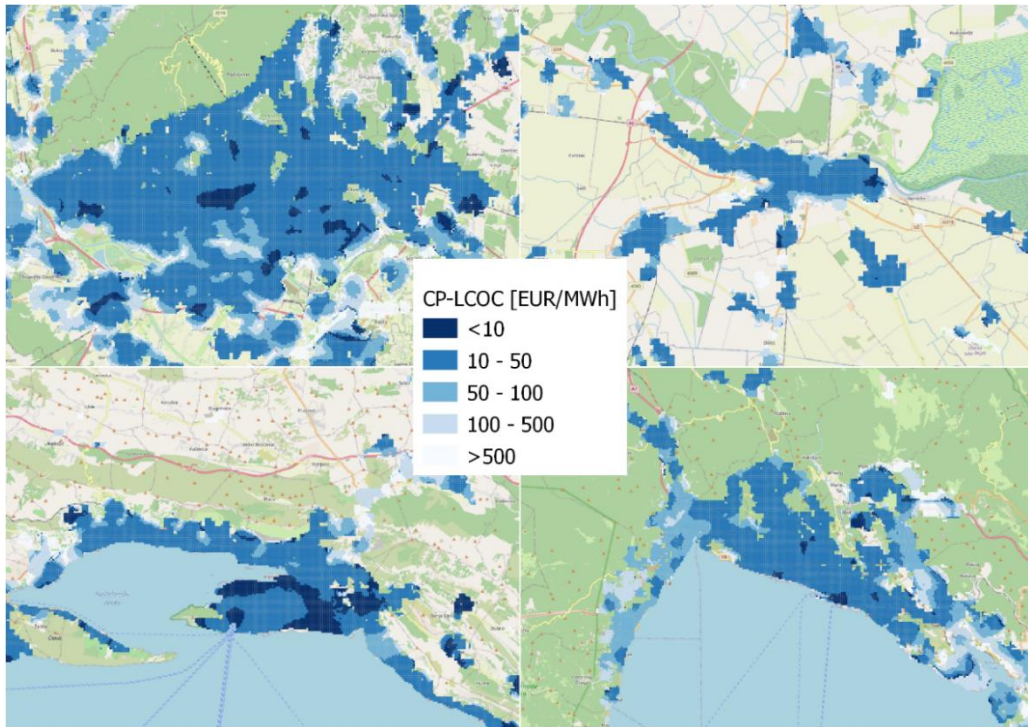
CP-LCOC [EUR]	250 EUR/m		500 EUR/m		750 EUR/m		1.000 EUR/m	
	BU	TD	BU	TD	BU	TD	BU	TD
<2	0,23%	0,36%	0,23%	0,07%	0,23%	0,04%	0,23%	0,02%
<5	10,21%	11,12%	0,24%	0,98%	0,23%	0,25%	0,23%	0,12%
<10	34,11%	41,71%	10,21%	11,12%	0,84%	3,83%	0,24%	0,98%
<20	72,10%	89,57%	34,11%	41,71%	16,98%	19,77%	10,21%	11,12%
<30	86,42%	97,58%	56,76%	73,86%	34,11%	41,71%	20,91%	24,81%
<50	95,41%	99,35%	80,68%	95,32%	62,65%	80,77%	44,80%	60,26%
<100	98,32%	99,85%	95,41%	99,35%	89,37%	98,27%	80,68%	95,32%
<200	98,79%	99,95%	98,32%	99,85%	97,13%	99,66%	95,41%	99,35%
<500	99,04%	99,99%	98,85%	99,96%	98,71%	99,93%	98,57%	99,89%
<1.000	99,10%	100,00%	99,04%	99,99%	98,92%	99,98%	98,85%	99,96%

The comparison between the bottom-up and the top-down results presents a consistent overestimate of the viability of DC in the case of the top-down mapping, opposite to the results obtained for DH. This is due to the higher differences in the specific cooling demands which in turn result in more cooling demand being concentrated in less areas when compared to DH. We can again see that the differences are more pronounced at lower grid costs where the cooling

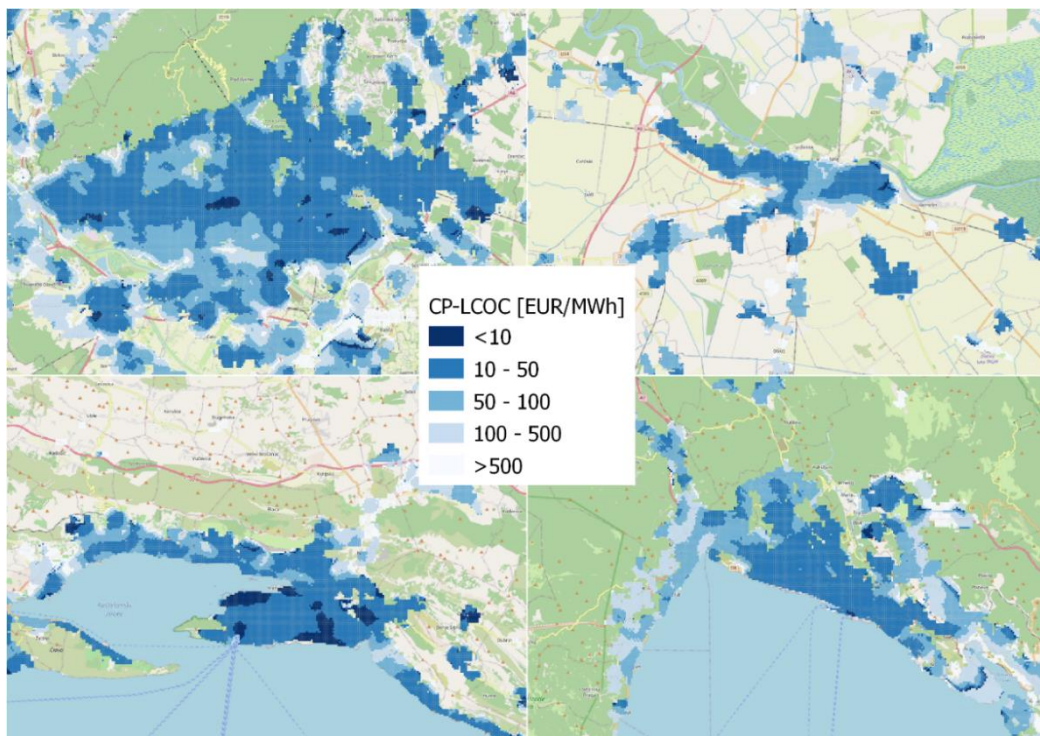
demand has a significantly higher impact. For example, at a CP-LCOC level of 20 EUR/MWh the bottom-up values for the share of cooling which is viable for district cooling equals 72,19%, 34,11%, 16,98% and 10,21% in the cases of grid costs of 250, 500, 750 and 1.000 EUR/m respectively. In the case of top-down, the values are 89,57%, 41,71%, 19,77% and 11,12%. Based on the observed differences, it is evident that the method is not suitable for detailed assessments for the purpose of the design of individual district cooling systems, however it can identify hot spots of increased demand and potential for the exploitation of district cooling. This assessment can serve as a basis for further in-depth analysis of smaller areas which will in turn require high quantities of data and provide more precise findings. This is especially important in the case of cooling when compared to heating due to the overestimation of the potential of the top-down method compared to bottom-up.



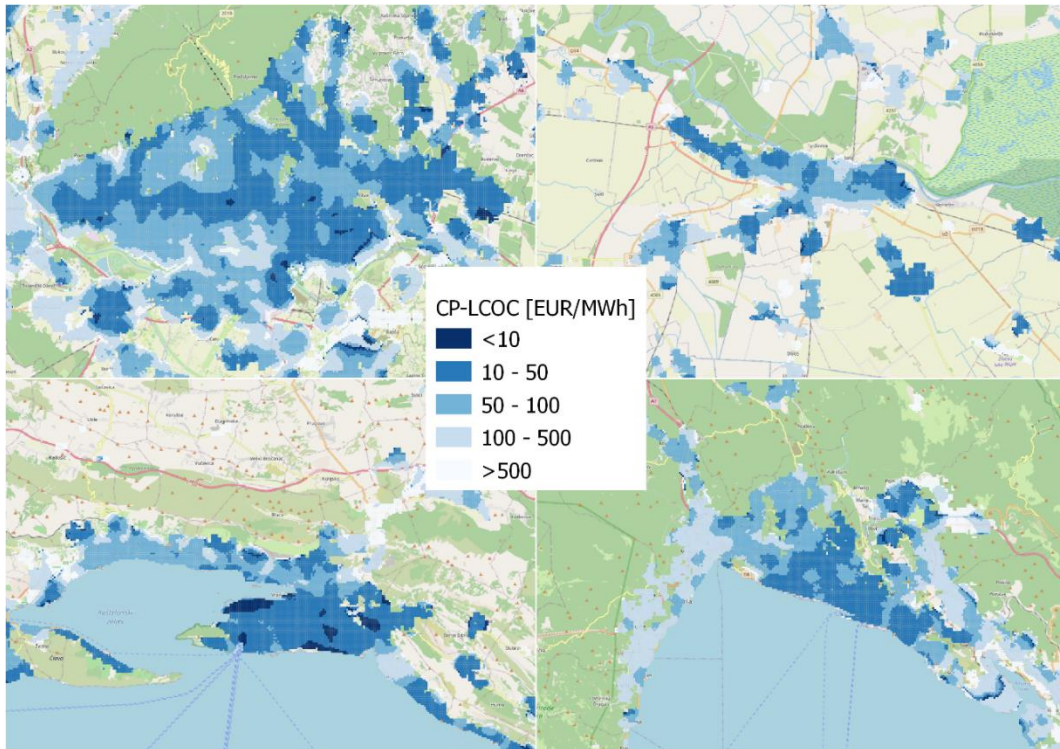
**Figure 14 Viability of district cooling at a grid price of 250 EUR/m (Top left: Zagreb, Top right: Osijek, Bottom left: Split, Bottom right: Rijeka)**



**Figure 15 Viability of district cooling at a grid price of 500 EUR/m (Top left: Zagreb, Top right: Osijek, Bottom left: Split, Bottom right: Rijeka)**



**Figure 16 Viability of district cooling at a grid price of 750 EUR/m (Top left: Zagreb, Top right: Osijek, Bottom left: Split, Bottom right: Rijeka)**



**Figure 17 Viability of district cooling at a grid price of 1000 EUR/m (Top left: Zagreb, Top right: Osijek, Bottom left: Split, Bottom right: Rijeka)**

Figure 14, Figure 15, Figure 16 and Figure 17 present the results of the assessment of the viability of district cooling for grid costs of 250 EUR/m, 500 EUR/m, 750 EUR/m and 1.000 EUR/m respectively, for four Croatian cities, two continental and two coastal. The results demonstrate both a strong impact of the grid costs and of the climate conditions on the overall viability of district cooling. The two coastal cities (bottom left and right) are both much smaller and less densely populated than Zagreb (top left) and they still maintain a much stronger and more consistent viability for district cooling as the grid costs increase.

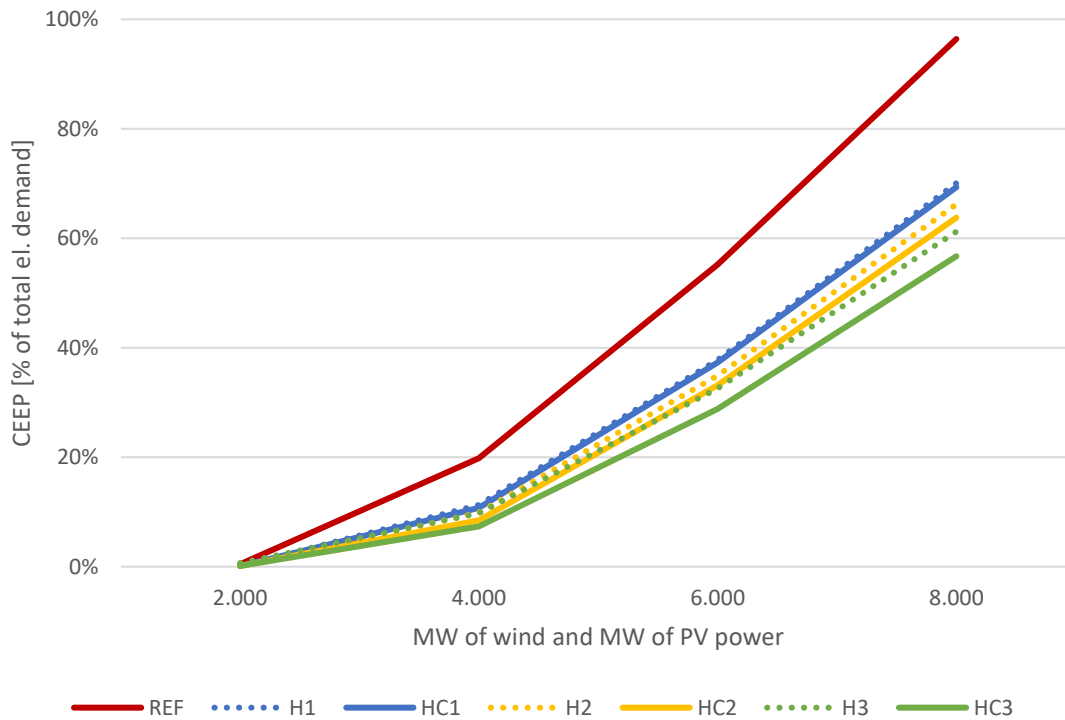
Table 8 demonstrates the same results as the previous four figures. It presents a strong potential for the utilisation of district cooling in Croatia. At CP-LCOC levels of below 10 EUR/MWh, between 1,5 and 26,43% of the overall cooling demand in the country could be feasibly supplied by district cooling, depending on the grid costs. These shares increase to a range of 15,76 to 87,86% if the level is increased to 30 EUR/MWh.

**Table 8 Results of the assessment of the viability of district cooling – Top-down results for Croatia**

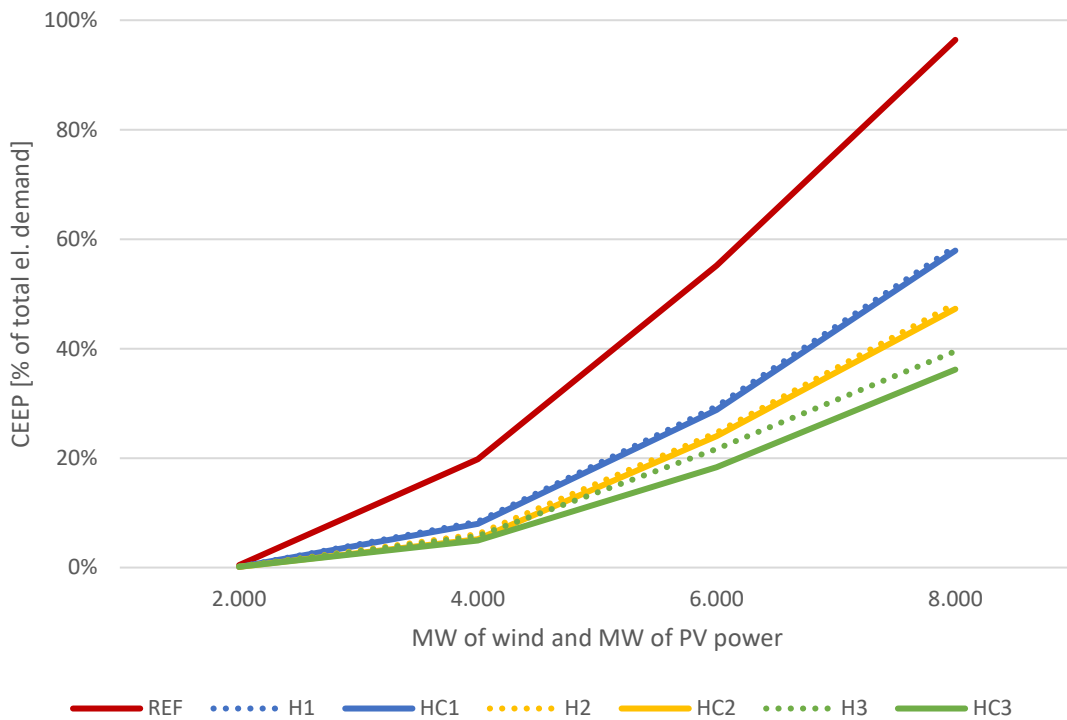
<b>CP-LCOC [EUR]</b>	<b>250 EUR/m</b>	<b>500 EUR/m</b>	<b>750 EUR/m</b>	<b>1.000 EUR/m</b>
<2	0,98%	0,29%	0,17%	0,13%
<5	7,26%	1,50%	0,69%	0,42%
<10	26,43%	7,26%	3,05%	1,50%
<20	69,96%	26,43%	12,72%	7,26%
<30	87,85%	50,87%	26,43%	15,76%
<50	96,44%	81,30%	58,16%	39,09%
<100	99,11%	96,44%	90,59%	81,30%
<200	99,67%	99,11%	98,12%	96,44%
<500	99,91%	99,76%	99,58%	99,36%
<1.000	99,97%	99,91%	99,83%	99,76%

### **3.3 Impact of district heating and cooling on the potential for the utilization of variable electricity generation**

Once the potential for the utilization of DH and DC has been established, the assessment of their impact on the increase of the flexibility of the overall energy system, and therefore the utilization of intermittent RES could be implemented. The results of these assessments can be seen in the figures and tables below. Figure 18 presents the results of all 7 scenarios including the reference and the 6 combinations of DH and DC with a set limit for the use of electric boilers of 600 MW across all considered systems. Figure 19 presents the same results but with the limit on electric boilers set to 2.500 MW.



**Figure 18 CEEP for all scenarios with electrical boiler limit of 600 MW**



**Figure 19 CEEP for all scenarios with electrical boiler limit of 2.500 MW**

Table 9 shows the CEEP of the reference scenario and the six scenarios which include DH and/or DC with both electric boiler limits. It is evident from the presented results that the



increase in the DH and DC capacities impacts the potential for the utilization of intermittent renewables both favourably and significantly. If we compare the reference with any of the other six scenarios, we can observe a sharp decline in CEEP. For instance, in the case of the highest installed capacity of wind and PV power, 8.000 MW each, we can see that the CEEP is above 96% of the total electricity demand. If we compare that to scenario HC3 we can see that the number drops to roughly 57% in the case with a 600MW electric boiler limit and 36% if the limit is set to 2.500 MW. We can also observe a noticeable impact of DC on the reduction of CEEP across all cases. If we disregard the results for 2.000 MW of installed wind and PV as the CEEP is almost negligible, the average reduction in CEEP when DC is added to the systems is close to 12%. Considering the relatively small cooling demand compared to heating as well as the fact that DH was set to values ranging from 30-90% compared to the 10-50% for DC, this can be considered a significant impact. If we look at the results of HC3, the system could easily absorb 4.000 MW of wind and 4.000 MW of PV which would produce upwards 17,13 TWh of electricity with roughly 5% CEEP. The total electricity demand in this case, including electricity for heat production (for the operation of the installed heat pumps), is 23,5 TWh, meaning that wind and PV could cover 73% of the total annual electricity demand with minimal CEEP. In comparison, the total electricity demand for the entirety of the Republic of Croatia is 18,32 TWh in the reference case.

**Table 9 CEEP for all scenarios**

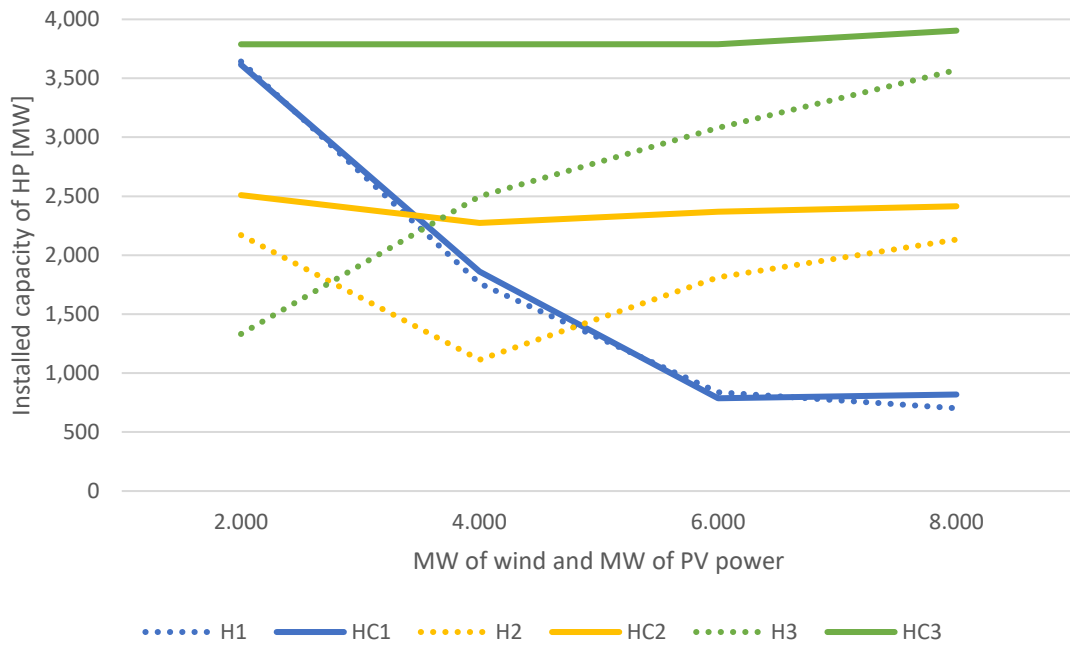
	Scenario	Installed wind and installed PV power [MW]			
		2.000	4.000	6.000	8.000
<b>Max. el. boiler</b>	<b>REF</b>	0,45%	19,81%	55,19%	96,41%
<b>600 MW</b>	<b>H1</b>	0,12%	11,27%	37,77%	70,06%
<b>600 MW</b>	<b>HC1</b>	0,11%	10,78%	37,30%	69,34%
<b>600 MW</b>	<b>H2</b>	0,14%	9,87%	34,93%	66,20%
<b>600 MW</b>	<b>HC2</b>	0,13%	8,46%	33,15%	63,77%
<b>600 MW</b>	<b>H3</b>	0,68%	9,76%	32,57%	61,21%
<b>600 MW</b>	<b>HC3</b>	0,14%	7,35%	28,80%	56,72%

<b>2.500 MW</b>	<b>H1</b>	0,12%	8,39%	29,42%	58,67%
<b>2.500 MW</b>	<b>HC1</b>	0,11%	7,96%	28,81%	57,91%
<b>2.500 MW</b>	<b>H2</b>	0,14%	6,14%	24,64%	48,23%
<b>2.500 MW</b>	<b>HC2</b>	0,13%	5,19%	24,03%	47,28%
<b>2.500 MW</b>	<b>H3</b>	0,20%	5,78%	21,65%	39,52%
<b>2.500 MW</b>	<b>HC3</b>	0,14%	4,94%	18,35%	36,17%

Table 10 and Figure 20 present the installed capacities of Heat pumps for all six scenarios with a 600 MW limit on electric boilers across all scenarios. Table 11 and Figure 21 present the same results for the 2.500 MW limit. It is important to note that the installed capacities are aggregated across all systems, however the model selects them per system and utilizes them only in the one they are linked to. The utilization of Heat pumps varies across the scenarios, and it greatly depends on the availability of electric boilers. Due to their lower investment costs and lower efficiency which result in the ability to consume more electricity when excess is produced, the model prefers electric boilers at higher penetrations of intermittent renewables as they can utilize more electricity at a lower cost. This is especially evident in scenarios with a smaller share of DHC in which the system can't utilize the large amount of heat which would be produced by efficient heat pumps, so it chooses to gradually reduce investments in heat pumps and replace them with electric boiler to utilize excess electricity. This impact is less evident in larger systems with a higher heating and cooling demands. In some of these cases, the investments into Heat pumps continue to increase, especially when electric boilers are limited, to enable the utilization of the produced electricity. Heat pumps are also essential in the scenarios with cooling as they are the only source of cooling the scenarios permit.

**Table 10 Installed capacity of Heat pumps [MW] for all scenarios with a 600 MW limit on electric boilers**

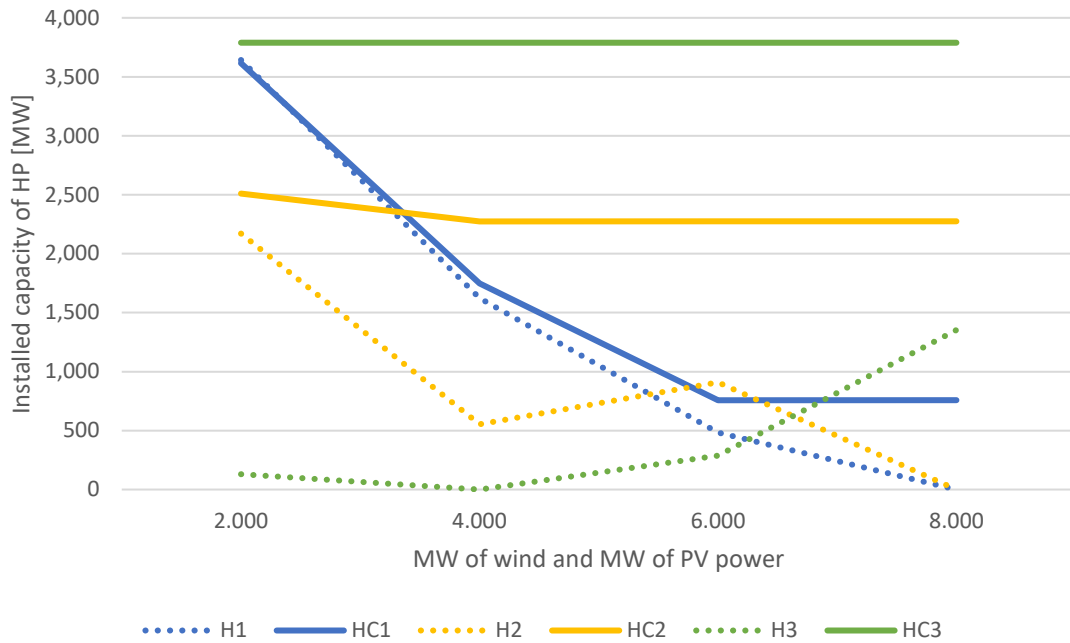
Scenario	Installed wind and installed PV power [MW]			
	2.000	4.000	6.000	8.000
<b>H1</b>	3.643	1.761	839	702
<b>HC1</b>	3.615	1.861	787	817
<b>H2</b>	2.171	1.113	1.812	2.133
<b>HC2</b>	2.510	2.273	2.368	2.415
<b>H3</b>	1.332	2.500	3.081	3.570
<b>HC3</b>	3.789	3.789	3.789	3.904



**Figure 20 Installed capacity of Heat pumps [MW] for all scenarios with a 600 MW limit on electric boilers**

**Table 11 Installed capacity of Heat pumps [MW] for all scenarios with a 2.500 MW limit on electric boilers**

Scenario	Installed wind and installed PV power [MW]			
	2.000	4.000	6.000	8.000
<b>H1</b>	3.643	1.623	484	0
<b>HC1</b>	3.615	1.749	758	758
<b>H2</b>	2.171	553	908	0
<b>HC2</b>	2.510	2.273	2.273	2.273
<b>H3</b>	131	0	288	1.353
<b>HC3</b>	3.789	3.789	3.789	3.789



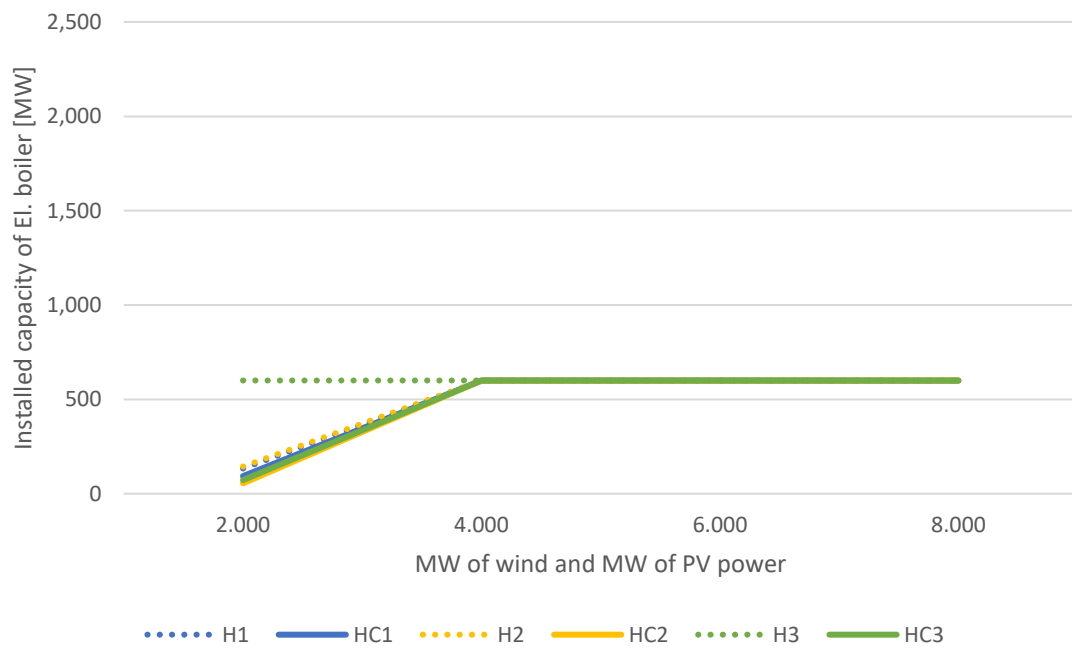
**Figure 21 Installed capacity of Heat pumps [MW] for all scenarios with a 2.500 MW limit on electric boilers**

Table 12 and Table 13 as well as Figure 22 and Figure 23 present the investments into electric boilers. As mentioned above, due to their low cost and low efficiency, the model prioritizes them as a power to heat option. It can be seen that the model continuously increases the investments into this technology up to the set limit and that their shares are lower in the scenarios with DC. This is to be expected as heat pumps are the only available source of cooling, so their utilization reduces the need for electric boilers.

**Table 12 Installed capacity of Electric boilers [MW] for all scenarios with a 600 MW limit on electric boilers**

Scenario	Installed wind and installed PV power [MW]			
	2.000	4.000	6.000	8.000
H1	133	600	600	600
HC1	93	600	600	600

<b>H2</b>	144	600	600	600
<b>HC2</b>	55	600	600	600
<b>H3</b>	600	600	600	600
<b>HC3</b>	72	600	600	600

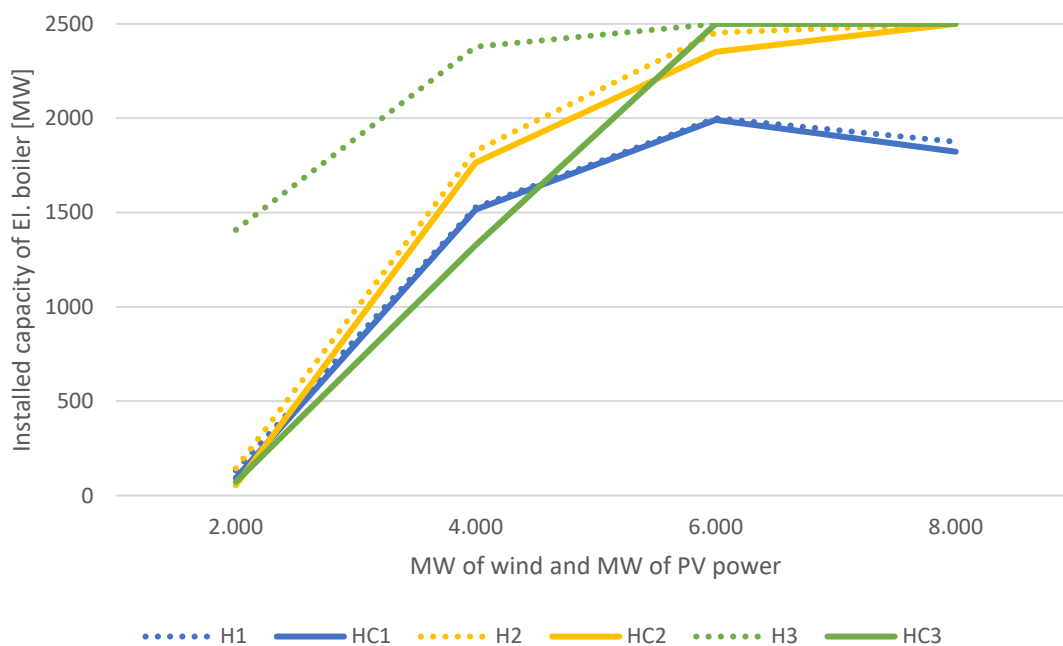


**Figure 22 Installed capacity of Electric boilers [MW] for all scenarios with a 600 MW limit on electric boilers**

**Table 13 Installed capacity of Electric boilers [MW] for all scenarios with a 2.500 MW limit on electric boilers**

Scenario	Installed wind and installed PV power [MW]			
	2.000	4.000	6.000	8.000
<b>H1</b>	133	1.528	2.000	1.875
<b>HC1</b>	93	1.515	1.991	1.822

<b>H2</b>	144	1.828	2.453	2.500
<b>HC2</b>	55	1.765	2.352	2.500
<b>H3</b>	1.408	2.379	2.500	2.500
<b>HC3</b>	72	1.327	2.500	2.500



**Figure 23 Installed capacity of Electric boilers [MW] for all scenarios with a 2.500 MW limit on electric boilers**

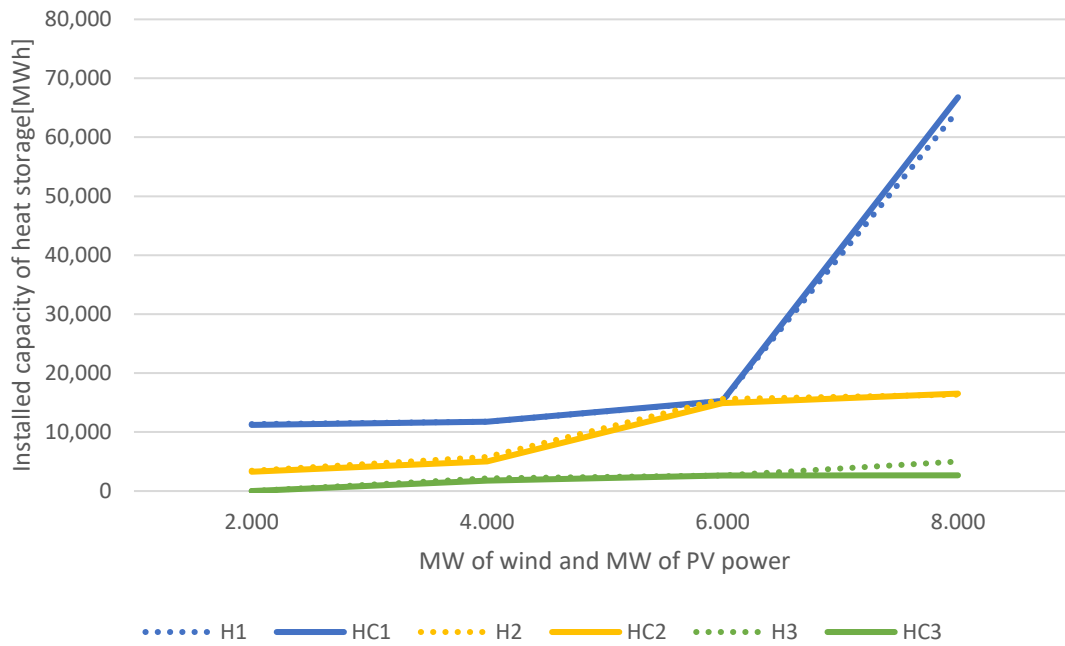
Finally, Table 14 and Table 15 as well as Figure 24 and Figure 25 present the installed capacities of heat storage across all scenarios. It can be seen from the results that, as expected, an increase in the penetration of intermittent sources increases the need for energy storage. It is interesting to observe that higher shares of electric boiler led the model to select higher storage capacities. This can be attributed to the fact that CEEP has not been limited to a set value, but a cost has been attributed to it, meaning that at a certain level of investments into a combination of heat pumps and storage, the model decided that it is less costly to tolerate higher shares of CEEP

then to continue investments into heat storage. It can also be seen that higher shares of DHC also reduced the need for heat storage due to the capacity of the larger systems to absorb more of the electricity produced via power to heat (or in this case cooling) systems.

**Table 14 Installed capacity of Heat storage [MWh] for all scenarios with a 600 MW limit on electric boilers**

Scenario	Installed wind and installed PV power [MW]			
	2.000	4.000	6.000	8.000
<b>H1</b>	11.352	11.781	15.261	64.569
<b>HC1</b>	11.217	11.781	15.298	66.787
<b>H2</b>	3.446	5.772	15.603	16.352
<b>HC2</b>	3.274	5.010	14.899	16.529
<b>H3</b>	0	2.158	2.628	5.010
<b>HC3</b>	0	1.796	2.615	2.664

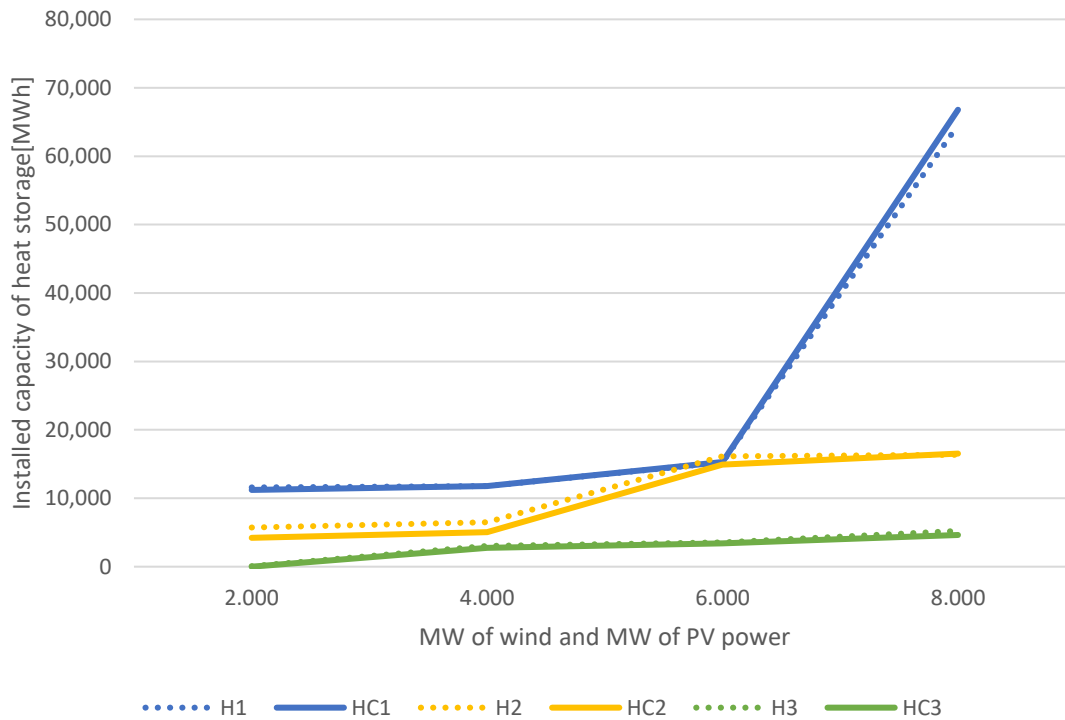




**Figure 24 Installed capacity of Heat storage [MWh] for all scenarios with a 600 MW limit on electric boilers**

**Table 15 Installed capacity of Heat storage [MWh] for all scenarios with a 2.500 MW limit on electric boilers**

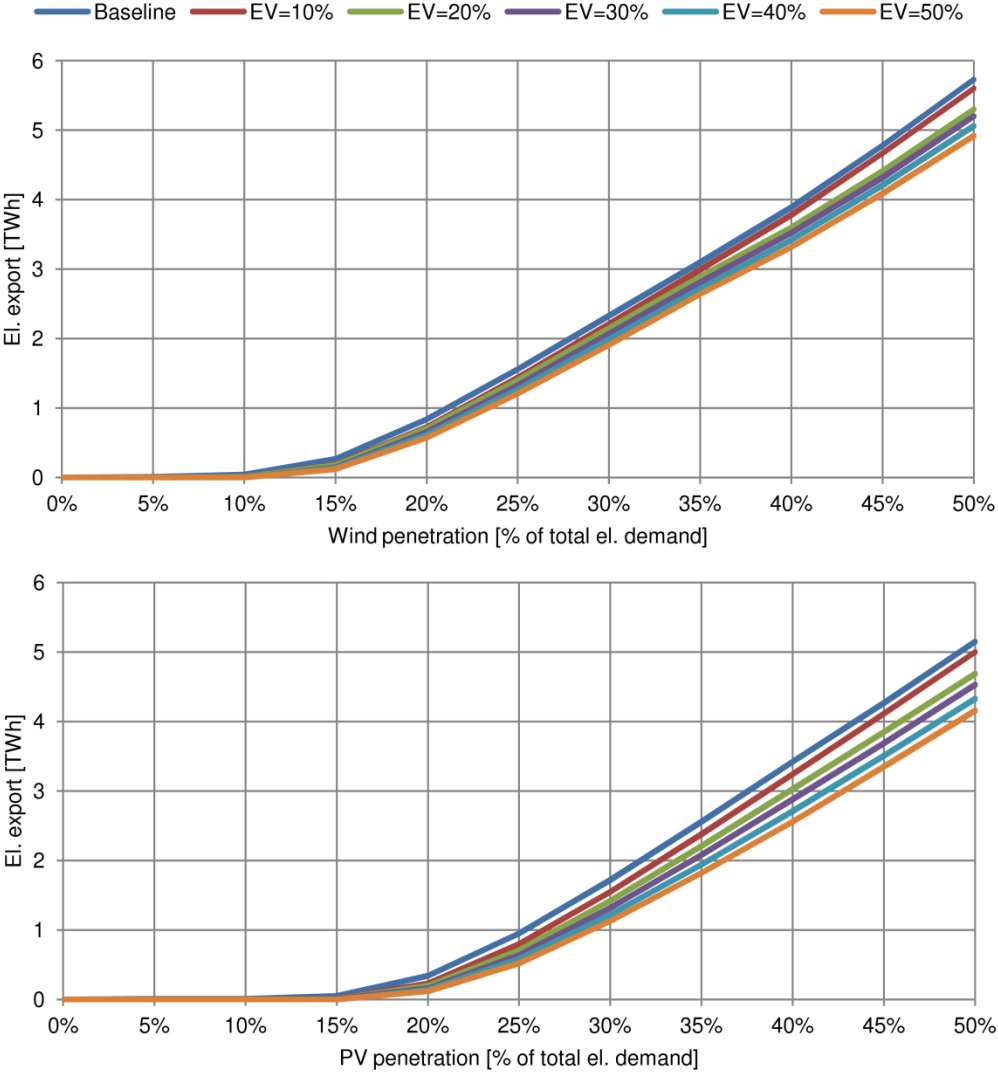
Scenario	Installed wind and installed PV power [MW]			
	2.000	4.000	6.000	8.000
<b>H1</b>	11.585	11.781	15.261	64.569
<b>HC1</b>	11.217	11.781	15.298	66.787
<b>H2</b>	5.724	6.513	16.124	16.352
<b>HC2</b>	4.221	5.058	14.899	16.529
<b>H3</b>	76	3.056	3.526	5.227
<b>HC3</b>	0	2.750	3.425	4.633



**Figure 25 Installed capacity of Heat storage [MWh] for all scenarios with a 2.500 MW limit on electric boilers**

DH and DHC have thus demonstrated their capacity to significantly and positively impact the potential to integrate intermittent RES into the overall energy system. This impact can be compared to that of other demand side management options such as electric mobility for instance. Figure 26 presents results of the research conducted in [72], in which the impacts of different shares of electric vehicles (EVs) (ranging from 10 to 50% of the entire vehicle fleet) could reduce CEEP, presented as electricity export, in systems with a high share of wind and PV (ranging from 0 to 50% of the total electricity demand). A vehicle to grid charging mode has been assumed in all scenarios. It can be observed from the figure that a penetration of wind higher than 10% or PV higher than 15% will result in CEEP. In the case of the scenarios that include wind power, its penetration of 15% with no EVs resulted in CEEP of 0.27 TWh, or 0.12 TWh for an EV share of 50%. In the case of a 50% wind power penetration the figures go up to 5.73 TWh with no EVs and 4.92 TWh with an EV share of 50%. The results are similar for the scenarios with PV, although the export is somewhat reduced. For the case with a PV penetration of 15% and no EVs, CEEP equals 0.05 TWh. There is no CEEP present in the same case with a 50% share of EVs. For a PV penetration of 50% and no EVs, CEEP equals 5.15 TWh and 4.16 TWh for an EV share of 50%. The difference in CEEP for a scenario with 50% wind penetration with no EVs and with 50% EVs is 0.81 TWh or roughly 4.4% of the total

electricity demand, excluding EVs, of Croatia in the reference year. In the case of PV, the difference is 0.99 TWh or roughly 5.3% of the total electricity demand excluding EVs for the same case.



**Figure 26 Export of electricity for scenarios with wind (top) and PV (bottom)**

From the presented results, it is evident that electrification can have a significant impact on the reduction of CEEP and therefore the potential to increase the share of intermittent RES. However, that impact is significantly lower than the potential of DH and DHC which have presented the ability to support a share of over 70% of intermittent RES in the electricity mix with a CEEP share of less than 5%.

### 3.4 Discussion

It is evident from the results of the presented research that a wide scale utilization of DH and especially DHC can have a significant and positive impact on the energy systems ability to integrate additional capacities of intermittent RES for electricity production. The utilization of DHC can provide the system with much needed flexibility by acting as a form of demand side response. To put the impacts DHC can have on the energy system into perspective against a reference energy system and alternatives such as electric vehicles, additional comparisons have been made. For this purpose, a reference energy scenario of the overall fuel and energy consumption and production for the Republic of Croatia has been created based on the one presented in [72], using the EnergyPLAN model [69]. The reference scenario has been updated with the hourly distribution curves developed for [66] and additional electricity generation has been added in the form of large thermal power plants to compensate the import of electricity which would otherwise be needed. The scenario has been marked as REF. Three additional scenarios have been created, one in which 50% of the land vehicles have been replaced with electric vehicles, as in the 50% electric vehicles scenario in [72], marked as EV, a scenario based on the HC3 scenario with 8.000 MW of installed wind and PV as presented in [66], marked as DHC, and a scenario which combines the electric vehicles and DHC marked as DHC+EV. In all scenarios with DHC, no additional electricity generation is needed due to the utilization of CHPs.

**Table 16 results of the comparison scenarios**

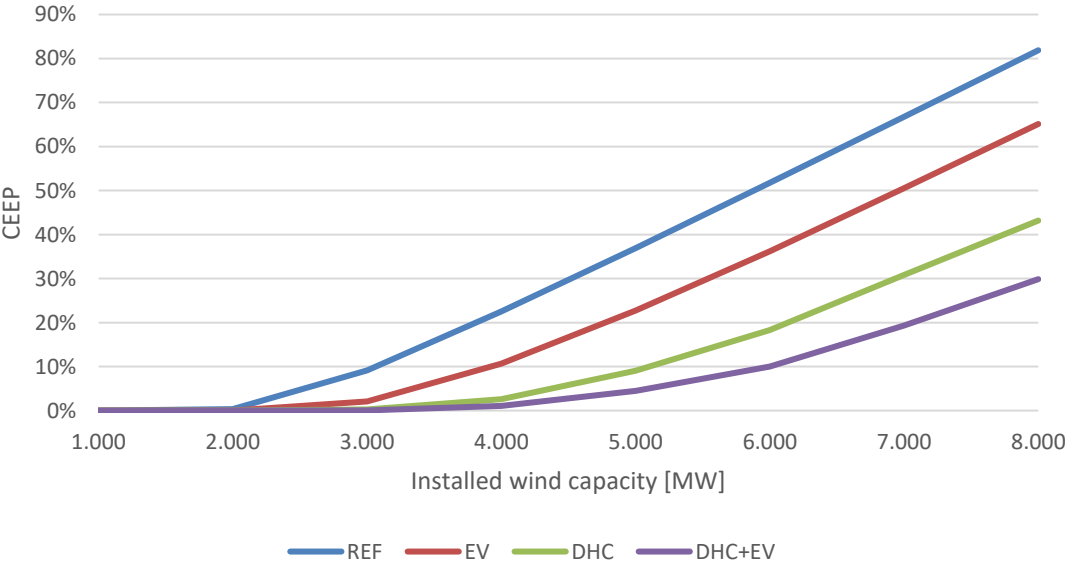
Scenario		Total cost [MEUR]	Total CO <sub>2</sub> [Mt]	CEEP [TWh]	CEEP	Total cost VS REF	Total CO <sub>2</sub> VS REF
3.000 MW	REF	11.960	16,14	5,71	31%	-	
	EV	11.261	13,89	3,07	17%	94%	86%
	DHC	11.612	13,8	1,09	6%	97%	86%
	DHC+EV	11.209	12,72	0,42	2%	94%	79%
4.000 MW	REF	12.148	15,89	9,78	53%	-	
	EV	11.423	13,38	6,83	37%	94%	84%
	DHC	11.498	12,12	3,9	21%	95%	76%
	DHC+EV	10.997	10,55	2,42	13%	91%	66%

Table 16 presents a summary of the results of the four developed comparison scenarios for cases with 3.000 and 4.000 MW of installed wind and PV power. We can observe that individually, DHC has a significantly larger impact on CEEP then the utilization of electric vehicles while their combined impact is even greater. For instance, if we observe the 4.000 MW

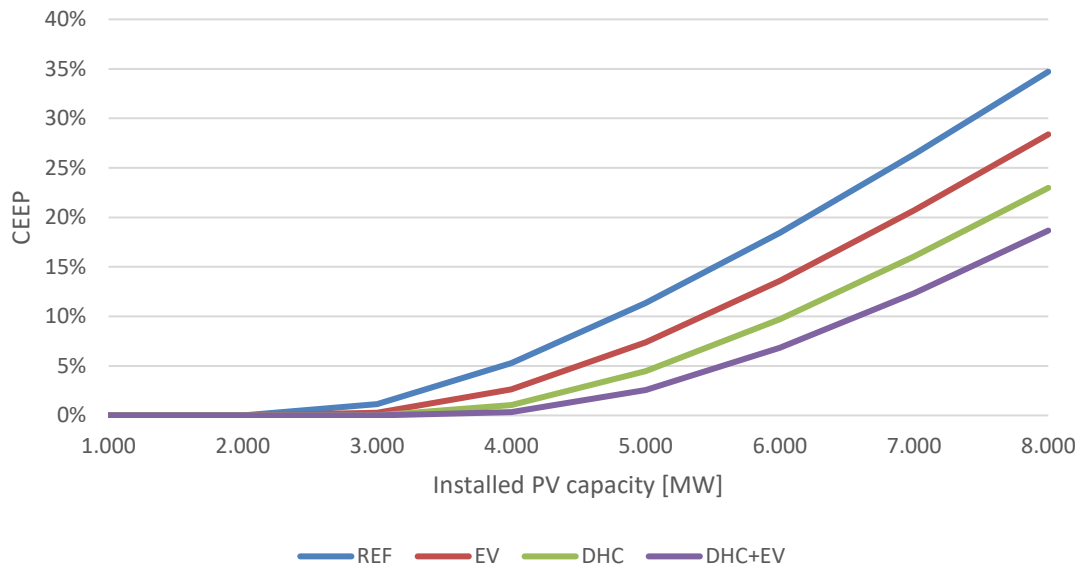
scenarios, we can see that the REF scenario generates 9,78 TWh of CEEP while the EV, DHC and DHC+EV scenarios generate 6,83 TWh, 3,9 TWh and 2,42 TWh respectively. The percentage values of CEEP in the table represent the share of CEEP against the baseline demand, meaning without the additional electricity demand for electric vehicles or heat generation.

We can also observe the positive impacts DHC has on the overall cost of the system and the CO<sub>2</sub> generation. For instance, we can see a reduction in costs and CO<sub>2</sub> by up to 9% and 34% respectively. It is important to note that electric vehicles were not accounted for in the costs, only the necessary charging infrastructure has. Both the cost and CO<sub>2</sub> reductions are the result of less fossil fuel consumption and less CEEP in systems with higher shares of DHC and DHC with electric vehicles.

Figure 27 and Figure 28 present CEEP for the four comparison scenarios for wind and PV generation respectively. From the presented figures, it is again evident that DHC has a significant and positive impact on the reduction of CEEP and therefore, the increase of the flexibility of the energy system overall as well as its capacity to take up higher shares of intermittent RES. Due to its higher load factor, wind has a stronger impact on CEEP than PV in all cases. Similarly to the table presented above, it is again evident that the highest reduction in CEEP can be achieved if a combination of demand side management options, such as DHC and electric vehicles, is implemented.



**Figure 27 CEEP for the comparison scenarios with wind generation**



**Figure 28 CEEP for the comparison scenarios with PV generation**

From the present comparison, it can be concluded that the utilization of DHC holds significant potential to increase the overall capacity of the energy system to take up high shares of intermittent RES with limited generation of CEEP. The results of such an integration are a significant reduction in the use of fossil fuels and thus a reduction in system costs and greenhouse gas emissions. When compared using the same methods and models, it is also evident that DHC can have a significantly stronger impact on CEEP reduction than the use of electric vehicles alone as per the developed scenarios, although their combined use yields best results. Therefore, the best option to increase the flexibility of energy systems, amongst the ones investigated, is a combined use of DHC and electric vehicles as they result in the lowest CEEP, system costs and overall greenhouse gas emissions.

# 4 CONCLUSIONS AND FUTURE WORK

In order to achieve the ambitious targets, the EU has set for its Member states, a strong push for the decarbonisation of its cities, and with that its heating and cooling sector, is needed. DHC systems present themselves as an ideal solution in this process as they enable the production and utilization of renewable and waste energy at locations where they are available and their distribution to the locations where they are needed at high enough energy densities. Additionally, they also allow for flexibility in terms of production technologies and energy sources as the majority of the system and the associated costs are linked to the distribution side which consists of hot water pipes and systems of distributing said water. Finally, as this thesis demonstrates, the utilization of DHC systems in a combination with power to heat and heat storage technologies can greatly increase the overall energy systems flexibility and in turn, increase its capacity to utilize intermittent RES. As DHC systems require substantial investments and works in order for them to be deployed, their viability greatly depends on the availability of high densities of heating and cooling demand as well as opportunities for the utilization of cheap and sustainable energy sources.

The main objective of this doctoral thesis is the assessment and quantification of the impact of DH and DHC on the potential for the utilization of intermittent RES in moderate and Mediterranean climates. The hypothesis of the thesis is that a high share of DH and DHC in a combination with power to heat and heat storage can have a significant and positive impact on the potential of the energy system as a whole to integrate more intermittent RES into its electricity generation without generating excessive CEEP in Europe's continental and Mediterranean climates. For this purpose, the research conducted within this work has focused on three key elements or research questions, namely: 1) assessment of the aggregate and spatially distributed heating and cooling demand; 2) assessment of the potential or the utilization of DH and DHC systems; and 3) assessment of the impact DH and DHC has on the potential to integrate intermittent RES for electricity generation. To achieve this, a method for the spatial assessment of heating and cooling demand with a focus on the use of publicly available data has been developed and implemented on the case studies of the Republic of

Croatia and the City of Zagreb. Following that, a method for the assessment of the viability of DH and DC systems has been developed and implemented on the same set of case studies. Finally, the H2RES model has been upgraded with the needed functionalities and utilized to perform the assessment of the impact DH and DHC have on the potential for the integration of PV and wind energy for electricity generation in systems with varying levels of DH and DHC utilization.

The doctoral thesis is based on six papers, four of which have been published in high impact factor CC journals, one in a Q2 journal and one conference paper. Paper 1 presents the initial development of a method for the spatial assessment of heat demand on a case study of a medium sized city. This method is further expanded on in Paper 2 which introduces the element of the assessment of the viability of DH and further enhances the spatial assessment of heating demand. Paper 3 assessed and demonstrated the potential impact electrification of the transport sector can have on the increase of the energy systems flexibility and its capacity to integrate high shares of intermittent RES. The results of this paper serve as a reference point for the capacity of DHC to do the same and enable additional comparisons of the impact and potential. The final method for the spatial assessment of heat demand and the assessment of the viability of DH using mostly public data has been finalized and demonstrated in Paper 4 while Paper 5 does the same for DC. Finally, Paper 6 presents the upgrades implemented in the H2RES modelling tool and the results of the assessment of the impact high shares of DH and DHC with power to heat and heat storage can have on the increase of the potential to integrate intermittent RES in energy systems. The republic of Croatia, and more specifically 9 cities in both the continental and Mediterranean climates, have been used as a case study for the assessment.

The results presented throughout the six research papers as well as this doctoral thesis have successfully confirmed the proposed hypothesis. Papers 4 and 5 demonstrate a high potential for the utilization of DH and DC in the assessed territories, while paper 6 demonstrates a significant and positive impact DH and DHC can have on the flexibility of energy systems, and with that the integration of intermittent RES, of territories in the EU's continental and Mediterranean climates. As seen in the results of paper 6, systems with a high share of DHC could easily absorb 4.000 MW of wind and 4.000 MW of PV which would produce upwards 17,13 TWh of electricity, or roughly 73% of the total electricity demand (including the additional demand from heat generation through heat pumps and electric boilers), with roughly 5% CEEP. In comparison, the total electricity demand for the entirety of the Republic of Croatia



is 18,32 TWh in the reference case. The results also demonstrate that DC, even though it represents a much smaller demand than DH and is integrated into the scenarios with much smaller shares, still decreases CEEP by up to an additional 12% when comparing DHC and DH scenarios.

The future work on this topic will include the development of methods to assess the viability and potential of heating and cooling sources utilizing public data as well as the further refinement of the existing methods for the assessment of heating and cooling demands and the viability of DH and DC. These assessments will enable even more detailed and precise calculations and visualisations of the potential to utilize DHC in areas where it is still underutilized.

Demand side management and flexibility of energy systems is and will be an increasingly important element as the share of RES, and especially intermittent RES such as PV and wind, rises. DHC is proving itself to be a key component of this logic and an asset with an exceptionally high potential to provide flexibility services to the electricity grid. This is an added benefit to the already proven potential to deliver sustainably generated heating and cooling from a variety of sources to the end-users. It is a key technology which needs wider adoption in Europe's mild and Mediterranean climates where it can bring all the benefits it is already providing to other territories across the continent.

# 5 LITERATURE

- [1] EUROPEAN COMMISSION, “A European strategic long-term vision for a prosperous, modern, competitive and climate neutral economy,” 2018. <https://eur-lex.europa.eu/legal-content/EN/TXT/HTML/?uri=CELEX:52018DC0773&from=EN> (accessed Oct. 07, 2019).
- [2] “REPowerEU: affordable, secure and sustainable energy for Europe | European Commission.” [https://ec.europa.eu/info/strategy/priorities-2019-2024/european-green-deal/repowereu-affordable-secure-and-sustainable-energy-europe\\_en](https://ec.europa.eu/info/strategy/priorities-2019-2024/european-green-deal/repowereu-affordable-secure-and-sustainable-energy-europe_en) (accessed Dec. 07, 2022).
- [3] Eurostat, “Greenhouse gas emission statistics - emission inventories,” 2019.
- [4] European Commission, “The Energy Performance of Buildings Directive Factsheet,” 2019.
- [5] United Nations, “2018 Revision of World Urbanization Prospects,” 2018.
- [6] D. Connolly, “Heat Roadmap Europe: Quantitative comparison between the electricity, heating, and cooling sectors for different European countries,” *Energy*, vol. 139, pp. 580–593, Nov. 2017, doi: 10.1016/j.energy.2017.07.037.
- [7] L. Miró, S. Brückner, and L. F. Cabeza, “Mapping and discussing Industrial Waste Heat (IWH) potentials for different countries,” *Renewable and Sustainable Energy Reviews*, vol. 51. Elsevier Ltd, pp. 847–855, Jul. 21, 2015. doi: 10.1016/j.rser.2015.06.035.
- [8] A. Luo, H. Fang, J. Xia, B. Lin, and Y. Jiang, “Mapping potentials of low-grade industrial waste heat in Northern China,” *Resour Conserv Recycl*, vol. 125, pp. 335–348, 2017, doi: 10.1016/j.resconrec.2017.06.018.
- [9] J. Huang, J. Fan, and S. Furbo, “Feasibility study on solar district heating in China,” *Renewable and Sustainable Energy Reviews*, vol. 108. Elsevier Ltd, pp. 53–64, Jul. 01, 2019. doi: 10.1016/j.rser.2019.03.014.
- [10] M. Huculak, W. Jarczewski, and M. Dej, “Economic aspects of the use of deep geothermal heat in district heating in Poland,” *Renewable and Sustainable Energy*

- Reviews*, vol. 49. Elsevier Ltd, pp. 29–40, May 10, 2015. doi: 10.1016/j.rser.2015.04.057.
- [11] H. Averfalk, P. Ingvarsson, U. Persson, M. Gong, and S. Werner, “Large heat pumps in Swedish district heating systems,” *Renewable and Sustainable Energy Reviews*, vol. 79, pp. 1275–1284, Nov. 2017, doi: 10.1016/J.RSER.2017.05.135.
- [12] H. Lund *et al.*, “4th Generation District Heating (4GDH). Integrating smart thermal grids into future sustainable energy systems.,” *Energy*, vol. 68, pp. 1–11, 2014, doi: 10.1016/j.energy.2014.02.089.
- [13] H. Lund, N. Duic, P. A. Østergaard, and B. V. Mathiesen, “Smart Energy and District Heating: Special Issue dedicated to the 2016 Conference on Smart Energy Systems and 4 th Generation District heating,” in *Energy*, Oct. 2018, vol. 160, pp. 1220–1223. doi: 10.1016/j.energy.2018.07.012.
- [14] H. Lund, N. Duic, P. A. Østergaard, and B. V. Mathiesen, “Future district heating systems and technologies: On the role of smart energy systems and 4th generation district heating,” *Energy*, vol. 165, pp. 614–619, Dec. 2018, doi: 10.1016/j.energy.2018.09.115.
- [15] “QGIS project!” <http://www.qgis.org/en/site/> (accessed May 18, 2017).
- [16] “ArcGIS.” <https://www.arcgis.com/index.html> (accessed Oct. 07, 2019).
- [17] J. Jangid *et al.*, “Potential zones identification for harvesting wind energy resources in desert region of India – A multi criteria evaluation approach using remote sensing and GIS,” *Renewable and Sustainable Energy Reviews*, vol. 65. Elsevier Ltd, pp. 1–10, Nov. 01, 2016. doi: 10.1016/j.rser.2016.06.078.
- [18] D. Viesi, A. Galgaro, P. Visintainer, and L. Crema, “GIS-supported evaluation and mapping of the geo-exchange potential for vertical closed-loop systems in an Alpine valley, the case study of Adige Valley (Italy),” *Geothermics*, vol. 71, pp. 70–87, Jan. 2018, doi: 10.1016/j.geothermics.2017.08.008.
- [19] D. Groppi, L. de Santoli, F. Cumo, and D. Astiaso Garcia, “A GIS-based model to assess buildings energy consumption and usable solar energy potential in urban areas,” *Sustain Cities Soc*, vol. 40, pp. 546–558, Jul. 2018, doi: 10.1016/j.scs.2018.05.005.

- [20] S. Pili, G. Desogus, and D. Melis, "A GIS tool for the calculation of solar irradiation on buildings at the urban scale, based on Italian standards," *Energy Build*, vol. 158, pp. 629–646, Jan. 2018, doi: 10.1016/j.enbuild.2017.10.027.
- [21] M. A. Anwarzai and K. Nagasaka, "Utility-scale implementable potential of wind and solar energies for Afghanistan using GIS multi-criteria decision analysis," *Renewable and Sustainable Energy Reviews*, vol. 71. Elsevier Ltd, pp. 150–160, 2017. doi: 10.1016/j.rser.2016.12.048.
- [22] Z. Defne, K. A. Haas, and H. M. Fritz, "GIS based multi-criteria assessment of tidal stream power potential: A case study for Georgia, USA," *Renewable and Sustainable Energy Reviews*, vol. 15, no. 5. Elsevier Ltd, pp. 2310–2321, 2011. doi: 10.1016/j.rser.2011.02.005.
- [23] A. Zyadin *et al.*, "Estimation of surplus biomass potential in southern and central Poland using GIS applications," *Renewable and Sustainable Energy Reviews*, vol. 89. Elsevier Ltd, pp. 204–215, Jun. 01, 2018. doi: 10.1016/j.rser.2018.03.022.
- [24] F. Venier and H. Yabar, "Renewable energy recovery potential towards sustainable cattle manure management in Buenos Aires Province: Site selection based on GIS spatial analysis and statistics," *J Clean Prod*, vol. 162, pp. 1317–1333, Sep. 2017, doi: 10.1016/j.jclepro.2017.06.098.
- [25] S. Zareei, "Evaluation of biogas potential from livestock manures and rural wastes using GIS in Iran," *Renew Energy*, vol. 118, pp. 351–356, Apr. 2018, doi: 10.1016/j.renene.2017.11.026.
- [26] V. Equere, P. A. Mirzaei, S. Riffat, and Y. Wang, "Integration of topological aspect of city terrains to predict the spatial distribution of urban heat island using GIS and ANN," *Sustain Cities Soc*, vol. 69, p. 102825, Jun. 2021, doi: 10.1016/j.scs.2021.102825.
- [27] A. W. M. J. van Schijndel and H. L. H. Schellen, "Mapping future energy demands for European museums," *J Cult Herit*, vol. 31, pp. 189–201, May 2018, doi: 10.1016/j.culher.2017.11.013.

- [28] F. Dutt, S. J. Quan, E. Woodworth, D. Castro-Lacouture, B. J. Stuart, and P. P. J. Yang, "Modeling algae powered neighborhood through GIS and BIM integration," in *Energy Procedia*, 2017, vol. 105, pp. 3830–3836. doi: 10.1016/j.egypro.2017.03.896.
- [29] S. Rahmouni, N. Settou, B. Negrou, and A. Gouareh, "GIS-based method for future prospect of hydrogen demand in the Algerian road transport sector," *Int J Hydrogen Energy*, vol. 41, no. 4, pp. 2128–2143, Jan. 2016, doi: 10.1016/j.ijhydene.2015.11.156.
- [30] K. N. Finney, V. N. Sharifi, J. Swithenbank, A. Nolan, S. White, and S. Ogden, "Developments to an existing city-wide district energy network - Part I: Identification of potential expansions using heat mapping," *Energy Convers Manag*, vol. 62, pp. 165–175, 2012, doi: 10.1016/j.enconman.2012.03.006.
- [31] H. C. Gils, J. Cofala, F. Wagner, and W. Schöpp, "GIS-based assessment of the district heating potential in the USA," *Energy*, vol. 58, pp. 318–329, Sep. 2013, doi: 10.1016/j.energy.2013.06.028.
- [32] M. Berger and J. Worlitschek, "A novel approach for estimating residential space heating demand," *Energy*, vol. 159, pp. 294–301, Sep. 2018, doi: 10.1016/j.energy.2018.06.138.
- [33] S. Nielsen and B. Möller, "GIS based analysis of future district heating potential in Denmark," *Energy*, vol. 57, pp. 458–468, Aug. 2013, doi: 10.1016/j.energy.2013.05.041.
- [34] B. Möller and S. Nielsen, "High resolution heat atlases for demand and supply mapping," *International Journal of Sustainable Energy Planning and Management*, vol. 1, pp. 41–58, 2014, doi: 10.5278/ijsepm.2014.1.4.
- [35] S. Petrović and K. Karlsson, "Ringkøbing-Skjern energy atlas for analysis of heat saving potentials in building stock," *Energy*, vol. 110, pp. 166–177, Sep. 2016, doi: 10.1016/j.energy.2016.04.046.
- [36] R. Lund and U. Persson, "Mapping of potential heat sources for heat pumps for district heating in Denmark," *Energy*, vol. 110, pp. 129–138, Sep. 2016, doi: 10.1016/J.ENERGY.2015.12.127.
- [37] S. Torabi Moghadam, J. Toniolo, G. Mutani, and P. Lombardi, "A GIS-statistical approach for assessing built environment energy use at urban scale," *Sustain Cities Soc*, vol. 37, pp. 70–84, Feb. 2018, doi: 10.1016/j.scs.2017.10.002.

- [38] R. Nouvel, A. Mastrucci, U. Leopold, O. Baume, V. Coors, and U. Eicker, “Combining GIS-based statistical and engineering urban heat consumption models: Towards a new framework for multi-scale policy support,” *Energy Build*, vol. 107, pp. 204–212, Nov. 2015, doi: 10.1016/j.enbuild.2015.08.021.
- [39] B. Möller, E. Wiechers, U. Persson, L. Grundahl, and D. Connolly, “Heat Roadmap Europe: Identifying local heat demand and supply areas with a European thermal atlas,” *Energy*, vol. 158, pp. 281–292, Sep. 2018, doi: 10.1016/j.energy.2018.06.025.
- [40] T. Ichinose and H. Kawahara, “Regional feasibility study on district sewage heat supply in Tokyo with geographic information system,” *Sustain Cities Soc*, vol. 32, pp. 235–246, Jul. 2017, doi: 10.1016/j.scs.2017.04.002.
- [41] B. Möller, E. Wiechers, U. Persson, L. Grundahl, R. S. Lund, and B. V. Mathiesen, “Heat Roadmap Europe: Towards EU-Wide, local heat supply strategies,” *Energy*, vol. 177, pp. 554–564, Jun. 2019, doi: 10.1016/j.energy.2019.04.098.
- [42] L. Pampuri, N. Cereghetti, D. Strepparava, and P. Caputo, “Analysis of the electricity consumptions: A first step to develop a district cooling system,” *Sustain Cities Soc*, vol. 23, pp. 23–36, May 2016, doi: 10.1016/J.SCS.2016.02.015.
- [43] C. Y. Yi and C. Peng, “Correlating cooling energy use with urban microclimate data for projecting future peak cooling energy demands: Residential neighbourhoods in Seoul,” *Sustain Cities Soc*, vol. 35, pp. 645–659, Nov. 2017, doi: 10.1016/J.SCS.2017.09.016.
- [44] E. Fahlén, L. Trygg, and E. O. Ahlgren, “Assessment of absorption cooling as a district heating system strategy - A case study,” in *Energy Conversion and Management*, Aug. 2012, vol. 60, pp. 115–124. doi: 10.1016/j.enconman.2012.02.009.
- [45] C. Y. Hsu, T. Y. Lin, J. De Liang, C. H. Lai, and S. L. Chen, “Optimization analysis of waste heat recovery district cooling system on a remote island: Case study Green Island,” *Energy Convers Manag*, vol. 183, pp. 660–670, Mar. 2019, doi: 10.1016/j.enconman.2019.01.028.
- [46] K. Thakar, R. Patel, and G. Patel, “Techno-economic analysis of district cooling system: A case study,” *J Clean Prod*, vol. 313, p. 127812, Sep. 2021, doi: 10.1016/j.jclepro.2021.127812.

- [47] Z. Shi, S. Hsieh, J. A. Fonseca, and A. Schlueter, "Street grids for efficient district cooling systems in high-density cities," *Sustain Cities Soc*, vol. 60, p. 102224, Sep. 2020, doi: 10.1016/j.scs.2020.102224.
- [48] Z. Shi, J. A. Fonseca, and A. Schlueter, "Floor area density and land uses for efficient district cooling systems in high-density cities," *Sustain Cities Soc*, vol. 65, p. 102601, Feb. 2021, doi: 10.1016/j.scs.2020.102601.
- [49] A. Alajmi and M. Zedan, "Energy, cost, and environmental analysis of individuals and district cooling systems for a new residential city," *Sustain Cities Soc*, vol. 54, p. 101976, Mar. 2020, doi: 10.1016/j.scs.2019.101976.
- [50] H. Golmohamadi, K. G. Larsen, P. G. Jensen, and I. R. Hasrat, "Integration of flexibility potentials of district heating systems into electricity markets: A review," *Renewable and Sustainable Energy Reviews*, vol. 159, p. 112200, May 2022, doi: 10.1016/J.RSER.2022.112200.
- [51] F. Xu, L. Hao, L. Chen, Q. Chen, M. Wei, and Y. Min, "Discussions on the real potential of district heating networks in improving wind power accommodation with temperature feedback as one consideration," *Energy Convers Manag*, vol. 250, p. 114907, Dec. 2021, doi: 10.1016/J.ENCONMAN.2021.114907.
- [52] E. Oró, P. Taddeo, and J. Salom, "Waste heat recovery from urban air cooled data centres to increase energy efficiency of district heating networks," *Sustain Cities Soc*, vol. 45, pp. 522–542, Feb. 2019, doi: 10.1016/j.scs.2018.12.012.
- [53] D. Meha, J. Thakur, T. Novosel, T. Pukšec, and N. Duić, "A novel spatial–temporal space heating and hot water demand method for expansion analysis of district heating systems," *Energy Convers Manag*, vol. 234, p. 113986, Apr. 2021, doi: 10.1016/j.enconman.2021.113986.
- [54] T. Novosel, T. Pukšec, G. Krajačić, and N. Duić, "Role of District Heating in Systems with a High Share of Renewables: Case Study for the City of Osijek," in *Energy Procedia*, 2016, vol. 95. doi: 10.1016/j.egypro.2016.09.019.

- [55] H. Dorotić, T. Novosel, N. Duić, and T. Pukšec, “Heat demand mapping and district heating grid expansion analysis: Case study of Velika Gorica,” in *E3S Web of Conferences*, 2017, vol. 19. doi: 10.1051/e3sconf/20171901021.
- [56] T. Novosel, T. Pukšec, N. Duić, and J. Domac, “Heat demand mapping and district heating assessment in data-poor areas,” *Renewable and Sustainable Energy Reviews*, vol. 131, p. 109987, Oct. 2020, doi: 10.1016/J.RSER.2020.109987.
- [57] Copernicus, “CORINE Land Cover — Copernicus Land Monitoring Service.” <https://land.copernicus.eu/pan-european/corine-land-cover> (accessed May 06, 2018).
- [58] JRC European Commission, “Global Human Settlement.” <https://ghsl.jrc.ec.europa.eu/index.php> (accessed Oct. 07, 2019).
- [59] “OpenStreetMap.” <https://www.openstreetmap.org/#map=7/50.510/4.475> (accessed Oct. 07, 2019).
- [60] “Tehnički propis o izmjenama i dopunama Tehničkog propisa o racionalnoj uporabi energije i toplinskoj zaštiti u zgradama.” [https://narodne-novine.nn.hr/clanci/sluzbeni/2020\\_09\\_102\\_1922.html](https://narodne-novine.nn.hr/clanci/sluzbeni/2020_09_102_1922.html) (accessed Jun. 20, 2021).
- [61] Ministry of Physical Planning Construction and State Assets, “Algorithm for the calculation of necessary energy for heating and cooling according to HRN EN ISO 13790.”
- [62] “Ministarstvo prostornoga uređenja, graditeljstva i državne imovine - Izvješća prema članku 5(2) Direktive 2010/31/EU i članku 6 Uredbe (EU) 244/2012 od 16.1.2012.” <https://mgipu.gov.hr/pristup-informacijama/zakoni-i-ostali-propisi/podrucje-energetske-ucinkovitosti/izvjescja-prema-clanku-5-2-direktive-2010-31-eu-i-clanku-6-uredbe-eu-244-2012-od-16-1-2012/8619> (accessed Jun. 20, 2021).
- [63] Ministarstvo graditeljstva i prostornog uređenja, “Dugoročna strategija za poticanje ulaganja u obnovu nacionalnog fonda zgrada Republike Hrvatske,” Zagreb, 2014.
- [64] T. Novosel, M. Grozdek, J. Domac, and N. Duić, “Spatial assessment of cooling demand and district cooling potential utilizing public data,” *Sustain Cities Soc*, vol. 75, p. 103409, Dec. 2021, doi: 10.1016/J.SCS.2021.103409.



- [65] L. Herc, A. Pfeifer, F. Feijoo, and N. Dui, “Energy system transitions pathways with the new H2RES model: A comparison with existing planning tool,” *Electronics and Energy*, vol. 1, p. 100024, 2021, doi: 10.1016/J.PRIME.2021.100024.
- [66] T. Novosel, F. Feijoo, N. Duić, and J. Domac, “Impact of district heating and cooling on the potential for the integration of variable renewable energy sources in mild and Mediterranean climates,” *Energy Convers Manag*, vol. 272, p. 116374, Nov. 2022, doi: 10.1016/J.ENCONMAN.2022.116374.
- [67] “Dispa-SET for the Balkans region — Documentation.” <http://www.dispaset.eu/en/latest/casebalkans.html> (accessed Jul. 14, 2022).
- [68] “Measurement of Domestic Hot Water Consumption in Dwellings”.
- [69] “EnergyPLAN | Advanced energy systems analysis computer model.” <http://www.energyplan.eu/> (accessed Feb. 24, 2018).
- [70] “Renewables.ninja.” <https://www.renewables.ninja/> (accessed Jul. 14, 2022).
- [71] Danish Energy Agency, “Technology Data for Energy Plants for Electricity and District heating generation,” Copenhagen, 2016.
- [72] T. Novosel *et al.*, “Agent based modelling and energy planning - Utilization of MATSim for transport energy demand modelling,” *Energy*, vol. 92, 2015, doi: 10.1016/j.energy.2015.05.091.

# 6 CURRICULUM VITAE

Tomislav Novosel was born on the 22<sup>nd</sup> of August 1987 in Zagreb, Croatia. He has obtained a Master's degree in Engineering at the University of Zagreb, Faculty of Mechanical Engineering and Naval Architecture in 2012. In 2013 he has enrolled in a PhD programme under the mentorship of Prof.Dr.Sc. Neven Duić and has begun working in his research group as a research assistant where he remained until 2018. In 2019 he began working in the North-West Croatia Regional Energy and Climate Agency as a Project Manager and was promoted to Expert Advisor in 2021.

During his university studies, Tomislav was awarded a scholarship from the Foundation "Hrvoje Požar" of the Croatian Energy Association. During his work as a research assistant, he has participated in two student exchanges. He has spent two semesters at the Ss. Cyril and Methodius University, Faculty of Electrical Engineering and Information Technologies in North Macedonia and three months at the Université Mohammed Premier Oujda in Morocco. He was also a member of the International Scientific committee of the ESCAPE 26 European Symposium on Computer Aided Process Engineering as well as a member of the local organising committee of 6 SDEWES conferences from 2013 until 2017.

Tomislav has worked on over 20 projects funded through national and EU programmes including three projects in the role of coordinator, namely the H2020 funded PentaHelix project, EIT Climate-KIC funded Transform4Climate and LIFE funded IN-PLAN projects. The aforementioned projects have covered a wide range of topics from the field of sustainable development and climate change mitigation as well as adaptation. The topics include district heating and cooling, integrated energy and climate planning, energy efficiency and utilization of renewables in the private and public sectors and national level policymaking.

During his PhD studies, Tomislav has co-authored 11 scientific papers in CC journals as well several conference papers and papers published in non CC journals. He has participated in more than 10 international scientific conferences where he has presented his research and has chaired several sessions. His current h-index according to Web of Science is 11. He serves as a reviewer in several high impact journals.

# 7 SUMMARY OF PAPERS

## PAPER 1

**T. Novosel, T. Pukšec, G. Krajačić and N. Duić, “Role of district heating in systems with a high share of renewables: Case study fir the city of Osijek,” *Energy Procedia*, vol. 95, pp. 337–343, 2016, doi: 10.1016/j.egypro.2016.09.019**

Within this paper a detailed heat mapping method has been presented and utilized. The method itself can be universally implemented at any location but the results of the process and its time intensity are highly dependent on the type and amount of data available. The heat demand mapping method has been primarily focused on the utilization of publicly available data to ensure the possibility that the same principle can be used on other cities/regions. The mapping process itself is handled in 3 steps:

- mapping of the locations and surface areas of buildings,
- identification of the number of floors,
- identification of the types of buildings.

Based on the three layers of information, a heat map can be initially developed based on the heated surface, determined by the area and number of floors, square area of space and the specific energy consumption of the identified building types. The results of the mapping process, and the time intensity of its implementation, will highly depend on the available data. The obtained results can be further complimented with the addition of several layers of information for example population density, energy certificates and others. The method has been demonstrated on a case study for the city of Osijek.

The analysis of the impact that DH systems have on the energy system as a whole have shown a reduction in CEEP of up to 35% for wind and almost 28% for PV. This demonstrates the importance DH systems have in the future large-scale integration of intermittent renewables in modern energy systems.

## PAPER 2

**H. Dorotić, T. Novosel, N. Duić, T. Pukšec, “Heat demand mapping and district heating grid expansion analysis: Case study of Velika Gorica” *E3S Web of Conferences*, vol. 19, 01021, 2017, doi: 10.1051/e3sconf/20171901021**

The research presented in this paper focuses on two key steps:

1. Assessment of the spatial heating demand of a determined area; and
2. Spatial assessment of the viability of district heating in said area.

The presented method builds on the previous research in which GIS based methods have already been successfully used for energy demand and supply mapping. In this paper the mapped heat demand has been used for an analysis of the potential for the expansion of the district heating grid. The city of Velika Gorica in Croatia has been chosen as a case study. To map the buildings and their heat demand, qGIS was used. The analysis of the potential for the expansion of the current DH system is based on an economic assessment to check if certain areas of a city can justify the installation of the new thermal grid. In order to make this assessment, five aspects are taken into the account:

- does a DH grid already exist in the area,
- the total heat demand in the area,
- levelized cost of heat (LCOH),
- potential revenue from the supply of heat,
- cost of a new grid in the area.

The results have shown that a total of more than 117 GWh could be supplied from the DH which is more than 59% of the total identify heating demand identified in the city.

### PAPER 3

**T. Novosel, L. Perkovi, M. Ban, H. Keko, T. Pukšec, G. Krajačić, N. Duić, “Agent based modelling and energy planning – Utilization of MATSim for transport energy demand modelling” *Energy*, vol. 92, pp. 466-475, 2015, doi:10.1016/j.energy.2015.05.091**

The goal of this paper is to model the hourly distribution of the energy consumption of electric vehicles and use the calculated load curves to test their impact on the Croatian energy system. The hourly demand for the transport sector has been calculated using the agent-based modelling tool MATSim on a simplified geographic layout. The impact EVs have on the energy system has been modelled using EnergyPLAN.

Agent based modelling can be a strong tool for the modelling of the hourly distribution of energy demand of the transport sector, however the quality of the results of the modelling will be highly dependent on the quality of the inputs.

The obtained hourly energy demand curves for the Croatian road transport sector have been used in the EnergyPLAN tool to analyse the impact of electric vehicles on Croatia's energy system and the potential for the increase of the penetration of wind power and PV. The results have shown that the electrification of the road transport sector can help reduce the fuel consumption by 12.3% and CO<sub>2</sub> emissions by 14.6% for the case of no renewables and a 50% share of electric vehicles. These numbers are even greater when higher penetrations of renewables are taken into account. A conducted sensitivity analysis has shown that the hourly distribution of the EV demand can have a strong influence on the obtained results at high levels of EV and intermittent RES penetration. In our case the difference in CEEP was up to 18% between the distribution generated using MATSim and a constant demand.

## PAPER 4

**T. Novosel, T. Pukšec, N. Duić, J. Domac, “Heat demand mapping and district heating assessment in data-poor areas” *Renewable and Sustainable Energy Reviews*, vol. 131, 109987, 2020, doi.org/10.1016/j.rser.2020.109987**

The research in this paper presents a method for heat mapping and spatial assessment of the viability of district heating in data-poor areas. It relies mostly on publicly available and, for the purpose of calibration and validation, municipally owned data. The method consists of the following three steps:

1. Calculation of aggregate heat demand per defined region;
2. Bottom up demand mapping of one region;
3. Top down demand mapping of the entire observed area.

The spatial assessment of the viability of district heating utilizes the difference between the average heat price and the levelized cost of heat instead of a fixed minimal density or cost curves to both provide a flexible set of results and be useable in cases where detailed economic and technical data is not available. This results in a flexible method which allows for a varied assessment of different areas considering a wide variety of potential heat sources and technologies.

The heat demand mapping and assessment of district heating viability has been implemented on the case of Croatia (steps 1 and 3) with the City of Zagreb used for the validation and calibration of the top-down mapping step (step 2). The results of the validation show an expected deviation between the results of the bottom-up and top-down mapping due to the difference in peaks in heat demand which are the result of the higher resolution of the data used in the bottom-up mapping. These deviations impact the assessments of the viability of district heating as well, with a stronger impact in cases where higher grid costs are assumed.

The overall method provides a flexible tool for the assessment of the viability of district heating systems in data poor areas, regardless of the utilized heat sources. The final results of this method do demonstrate a consistent underestimate of the DH potential due to the uniformity of the publicly available spatial data if compared to a detailed bottom-up assessment, however these discrepancies are mostly present in the cases where the assumed heat price is only marginally higher than the LCOH.

## PAPER 5

**T. Novosel, M. Grozdek, J. Domac, N. Duić, “Spatial assessment of cooling demand and district cooling potential utilizing public data” *Sustainable Cities and Society*, vol. 75, 103409, 2021, doi:10.1016/j.scs.2021.103409**

The research within this paper demonstrates a four-step approach for cooling demand mapping and the assessment of district cooling potential with an emphasis on the utilization of publicly available data. The method utilizes a combination of spatially distributed and aggregated datasets and a top-down and bottom-up approach to generate a 1 ha resolution cooling demand map and a spatial assessment of the viability for the utilization of district cooling of a large geographic area. The spatial assessment of the viability of district cooling utilizes the difference between the price of cooling and the LCOC instead of fixed costs and prices allowing for a great deal of flexibility in terms of local parameters such as technology, energy sources and prices. The presented method has been implemented on the case study of Croatia (top-down) and the City of Zagreb (bottom-up).

The results of the method do present a consistent overestimate of the potential for district cooling of the top-down compared to the bottom-up mapping; however, this is mostly evident in cases when the assumed cost of the district cooling grid is low (250 EUR/m in the case of this research) and when the price of cooling is only marginally higher than the LCOC. Overall, the method provides a flexible tool for the assessment of the viability of district cooling in various climate conditions and independent of the availability of high-quality local data. Although the method cannot provide the basis for the design of individual district cooling systems, it can serve as an initial assessment of a broad area for the identification of hot-spots of cooling demand and potential areas for the utilization of district cooling. The future work within this research will include the utilization of the identified potential for district cooling to assess its impact on the overall energy system as well as its potential integration with the heating and power sectors.

## PAPER 6

**T. Novosel, F. Feijoo, N. Duić, J. Domac, “Impact of district heating and cooling on the potential for the integration of variable renewable energy sources in mild and Mediterranean climates” *Energy Conversion and Management*, vol. 272, 116374, 2022, doi:10.1016/j.enconman.2022.116374**

The research in this paper presents the capabilities of the upgraded linear optimisation tool H2RES to set-up and model energy systems which consist of one electricity system and several DH and DHC systems as well as the impact DH and DHC can have on the potential for the utilization of intermittent energy sources such as wind and PV.

The presented version of H2RES has been updated to incorporate DC as one of its demand streams. The tool can model one or several DC systems in parallel, all connected to same overall electricity network, same as its previous capabilities to model DH. Additionally, the DHC systems can be connected so that technologies, such as heat pumps, can satisfy both the heating and cooling demand if set up in such a way.

The tool has been utilized to model an energy system consisting of several DHC systems in Mediterranean and mild climates with a goal to assess their impact on the potential for the utilization of intermittent renewables. The presented results demonstrate that the impacts are significant. When comparing the reference scenario with no DH or DC, we can see a sharp increase in the generation of CEEP of up to 96 % of the total electricity demand in the case with 8.000 MW of wind and 8.000 MW of PV. This figure drops to roughly 39 % and 36 % in the cases with the highest levels of DH and DHC. If we look at the scenario with the highest levels of DHC, we can see that at a level of 4.000 MW of wind and PV the CEEP is below 5 % of the total electricity demand which includes the electricity consumption of power to heat technologies when generating heat. Wind and PV generate 17,13 TWh of the total 23,5 TWh of electricity consumed in this scenario meaning that these two sources could generate 73 % of the total electricity demand while keeping CEEP below 5 %. The reference electricity demand of the Republic of Croatia is 18,23 TWh. The results also demonstrate a significant impact of DC on CEEP especially considering its low total demand compared to heating. Overall, the presented research clearly demonstrates the positive impacts widescale DHC utilization can have on the potential for the penetration of intermittent sources for the generation of electricity if power to heat technologies are utilized.



# PAPER 1



International Scientific Conference “Environmental and Climate Technologies – CONECT 2015”

## Role of district heating in systems with a high share of renewables: Case study for the city of Osijek

Tomislav Novosel<sup>a\*</sup>, Tomislav Pukšec<sup>a</sup>, Goran Krajačić<sup>a</sup>, Neven Duić<sup>a</sup>

<sup>a</sup>*University of Zagreb, Faculty of Mechanical Engineering and Naval Architecture, Ivana Lučića 5, 10000 Zagreb, Croatia*

---

### Abstract

Highly efficient cogeneration and district heating systems have significant potential for primary energy savings which are still highly underutilized in the European Union. They also represent a very important factor when it comes to the planning of future energy systems because of their potential to increase the flexibility of the overall system and therefore enable a higher level of the utilization of intermittent renewable energy sources like wind and photovoltaic. The goal of this work is to present and utilize a heat demand mapping methodology on a case study for the city of Osijek in Croatia and to analyze the potential such systems have on the increase of the penetration of intermittent renewables. The data obtained through the mapping process have been used to create several scenarios for the development of Osijek’s energy system with a high penetration of district heating, wind and solar energy. The EnergyPLAN modelling tool has been used to perform the energy system analysis created for this paper.

*Keywords:* District heating, heat demand mapping, EnergyPLAN, Osijek, Renewable energy systems, Energy planning

---

### 1. Introduction

Europe has recognized that the security of energy supply and the reduction of CO<sub>2</sub> emissions are key issues that will define the development of its energy systems. In order to face these issues, the European Commission has established the 20-20-20 goals stating that Europe will reduce its CO<sub>2</sub> emissions by 20%, increase the share of RES (renewable energy sources) by 20% and increase the overall energy efficiency by 20% until 2020 compared to 1990 levels [1]. According to the latest forecasts, the EU (European Union) is on track with its activities related to the decrease of CO<sub>2</sub> emissions and increase of the share of RES, but further actions are necessary if the goals of the increase of energy efficiency are to be met [2], as well as the goals of the reduction of CO<sub>2</sub> emission by 80-95% and an increase of the share of low carbon technologies to almost 100% by 2050. The energy sector is a key component

---

\* Corresponding author: Tel.: +385 98 570019; fax: +385 1 6156940

*E-mail address:* [tomislav.novosel@fsb.hr](mailto:tomislav.novosel@fsb.hr)

in achieving said goals since it is responsible for 79% of the EU's greenhouse gas emissions [3].

The utilization of highly efficient CHP (combined heat and power) units with DHC (district heating and cooling) systems that maximize the utilization of waste heat and locally available RES like solar, renewable biomass, biogas, geothermal and so on can greatly increase energy efficiency and reduce t CO<sub>2</sub> emissions of the energy sector. The utilization of power-to-heat technologies like heat pumps in conjunction with heat storage can also help to increase the potential for the utilization of intermittent RES like wind and PV and achieving a positive synergy between the heat and power sector.

The term "Fourth generation district heating systems" has been coined for DH (district heating) systems capable of tackling the issues modern energy systems will face and are currently facing. According to [4], future DH systems will have to be able to fulfil several roles in order to achieve this. They will have to be able to supply existing, renovated and new buildings with low temperature heating, minimize energy losses in the distribution system, use low-temperature waste heat and integrate RES as well as being an integral part of smart energy systems linking the power and heat sectors. Papers such as [5] have already shown that energy systems such as the Danish one could integrate upwards of 50% DH penetration and have highlighted its impact on the overall energy system if large scale heat pumps and heat storage would be integrated into it. The analysis in this work was mostly based around the cost of the system as a whole. Similar analyses have been conducted for other countries such as China [6], Sweden [7], UK [8], Italy [9] and France [10], among others. Other research has also demonstrated the positive impact of energy efficiency measures related to DH such as the reduction of the supply temperature [11], utilization of smart grids [12], renewables [13] and hybrid systems [14] for example.

The goal of this work is to demonstrate a heat demand mapping methodology and present the impact a DH that utilizes power to heat can have on the potential for the penetration of intermittent RES. The city of Osijek in Croatia has been selected as a case study for this work.

## 2. Methods used

In this chapter, the approach used both for the heat demand mapping and the energy planning is presented.

### 2.1. Heat demand mapping

The heat demand mapping method has been primarily focused on the utilization of publically available data to ensure the possibility that the same principle can be used on other cities/regions. The mapping process itself is handled in 3 steps:

- mapping of the locations and surface areas of buildings,
- identification of the number of floors,
- identification of the types of buildings.

Based on the three layers of information, a heat map can be initially developed based on the heated surface, determined by the area and number of floors, per square area of space and the specific energy consumption of the identified building types. The results of the mapping process, and the time intensity of its implementation, will highly depend on the available data. The obtained results can be further complimented with the addition of several layers of information for example population density, energy certificates and others.

### 2.2. EnergyPLAN

The energy system of the city of Osijek has been recreated using the EnergyPLAN [15] advanced energy system analyses tool for the purpose of this paper. EnergyPLAN is a deterministic input-output computer modelling tool that creates an annual analysis of an energy system with a time step of one hour. The required inputs include the total demand and demand curves for electricity, installed capacities and efficiencies of different types of energy producers and energy storage technologies, fuel mix, hourly distribution of energy production from intermittent

sources like wind and solar, energy demands for the different sectors and different regulation strategies. The results or outputs of the model include: energy balances, annual and hourly productions of energy and CEEP (critical access of electricity production), fuel consumptions, total cost of the system, CO<sub>2</sub> emissions and more.

Since it is a deterministic model, the model used for the study will always give the same results for the same set of input parameters. In order to speed up the calculation process EnergyPLAN uses analytical programming instead of iterations and aggregated data inputs for different units in the same sector. It optimizes the operation of the system, not the investments or emissions but it does offer the possibility to utilize different regulation strategies, to be exact, four technical optimization strategies and three market economic optimization strategies. The technical regulation strategy – Balancing both heat demand and electricity demands – has been used to create the base model and the scenarios for this paper. Figure 1 presents a schematic diagram of EnergyPLAN.

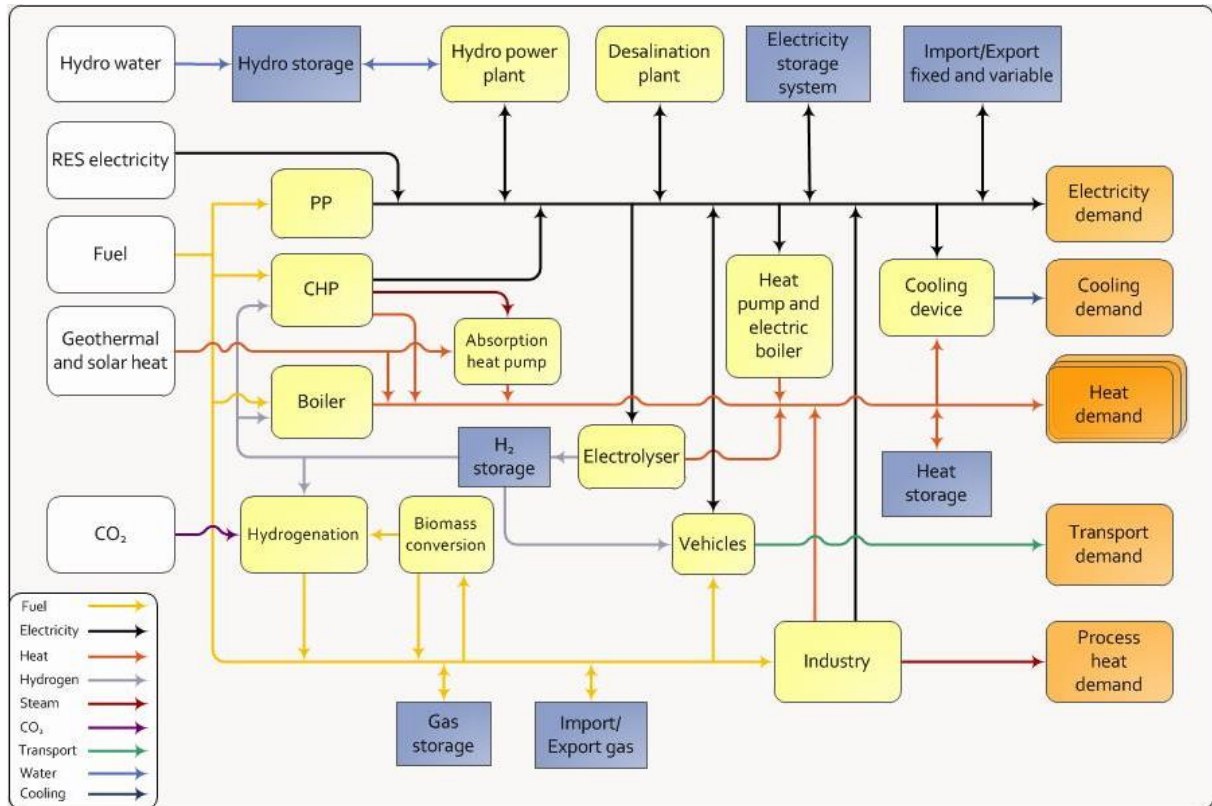


Fig. 1 EnergyPLAN model

EnergyPLAN is specialized in the large scale integration of RES in energy systems [16] and [17], analysis of the impact of the transport sector, especially electric vehicles, on the energy system [18] and [19], the optimal combination of RES [20] and the implementation of CHP units in energy systems [21]. It has already been used to recreate many different energy systems and devise numerous energy scenarios. For example, authors of [16] and [22] used the model to simulate different scenarios for the Macedonian energy system. In [21] and [23] EnergyPLAN has been used to model the Danish energy system and to analyze the potential for the integration of RES. The authors of [24] used both the EnergyPLAN and the H2RES [25] models to recreate the Croatian energy system and plan a 100% sustainable energy scenario.

### 3. Scenarios and results

#### 3.1. Heat mapping for the city of Osijek

Due to the lack of publically available data, the mapping process was handled manually in some aspects. The locations and area in square meters of the buildings in the city were obtained from the online cadaster Geoportal [26]. Based on the available data, a matrix with the locations of every structure and its area in  $m^2$  was created with a resolution of approximately 1 by 1 meters. After that the matrix was visualized as a black and white presentation of the city and the buildings were marked first based on the number of floors they had and then divided into one of six categories with an appropriate specific useful heating demand per square meter:

- old house - 250 kWh/m<sup>2</sup> annually
- new house – 125 kWh/m<sup>2</sup> annually
- old apartment block – 200 kWh/m<sup>2</sup> annually
- new apartment block – 100 kWh/m<sup>2</sup> annually
- industrial facility – 100 kWh/m<sup>2</sup> annually
- skyscraper – 110 kWh/m<sup>2</sup> annually.

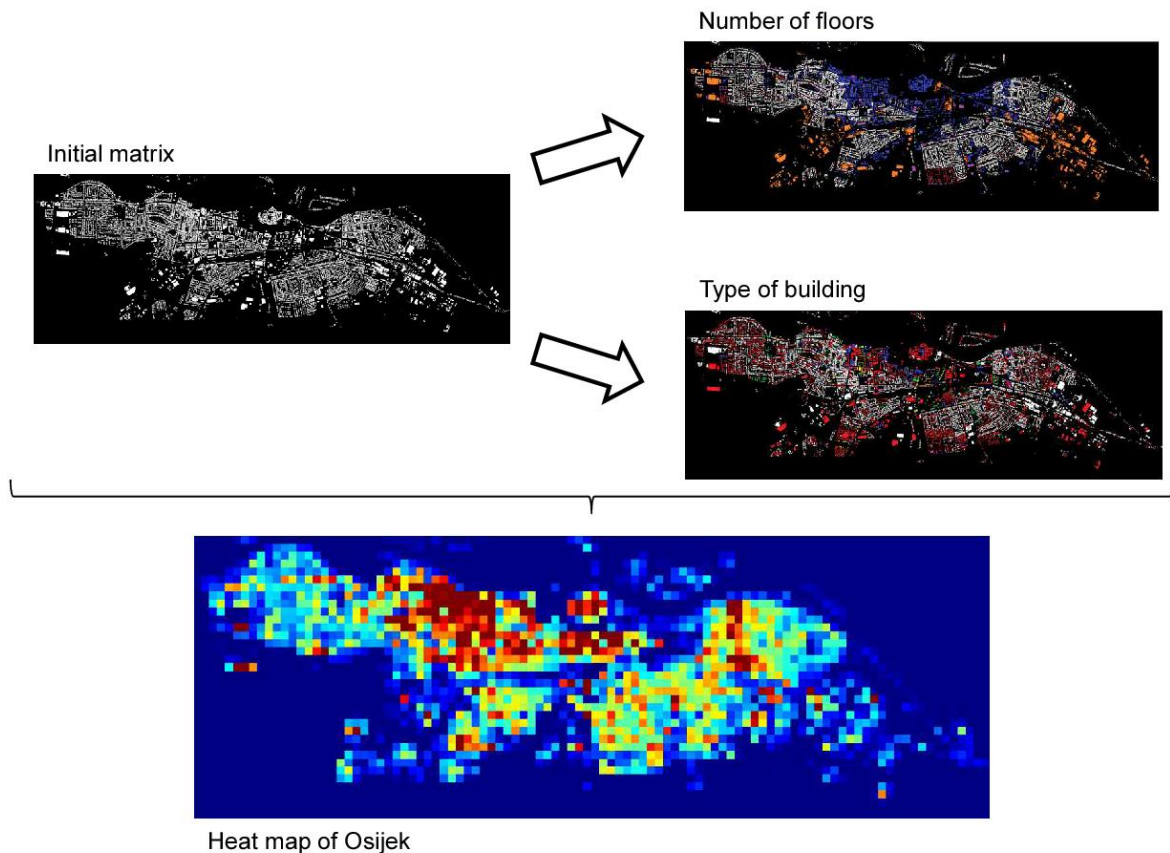


Fig. 2 Heat mapping of the city of Osijek

The presumed values for the individual building types were used based on data obtained from energy audits and expert knowledge. The existence of a building census would simplify the whole process greatly and would ensure that the end result is more precise. Unfortunately such building census data is not available for Croatia. Figure 2 presents the development process of the heat map and the final result. The first figure on the right demonstrates the initial matrix representing the locations and areas in square meters of the buildings within the city. The two figures on the right demonstrate the addition of the information related to the number of floors and the type of buildings while the final figure, the one on the bottom, presents the final heat map.

In future work the heat maps will be calibrated using available data and utilized to determine the actual potential for the utilization of DH systems.

### 3.2. Energy planning

In order to analyse the impact DH systems and power-to-heat technologies have on an energy system as a whole, the energy system of the city of Osijek was recreated using the EnergyPLAN tool. The energy demand of the individual sectors and the current share of the DH systems were taken from the city’s Sustainable Energy Action Plan [27]. The installed power of the DH plant was obtained from the official web site of the operator [28]. The hourly electricity load has been taken from the web site of the European Network of Transmission System Operators for Electricity [29]. Meteorological data including global insolation and wind speeds have been taken from Meteonorm [30] and used to calculate the hourly production from wind power and PV.

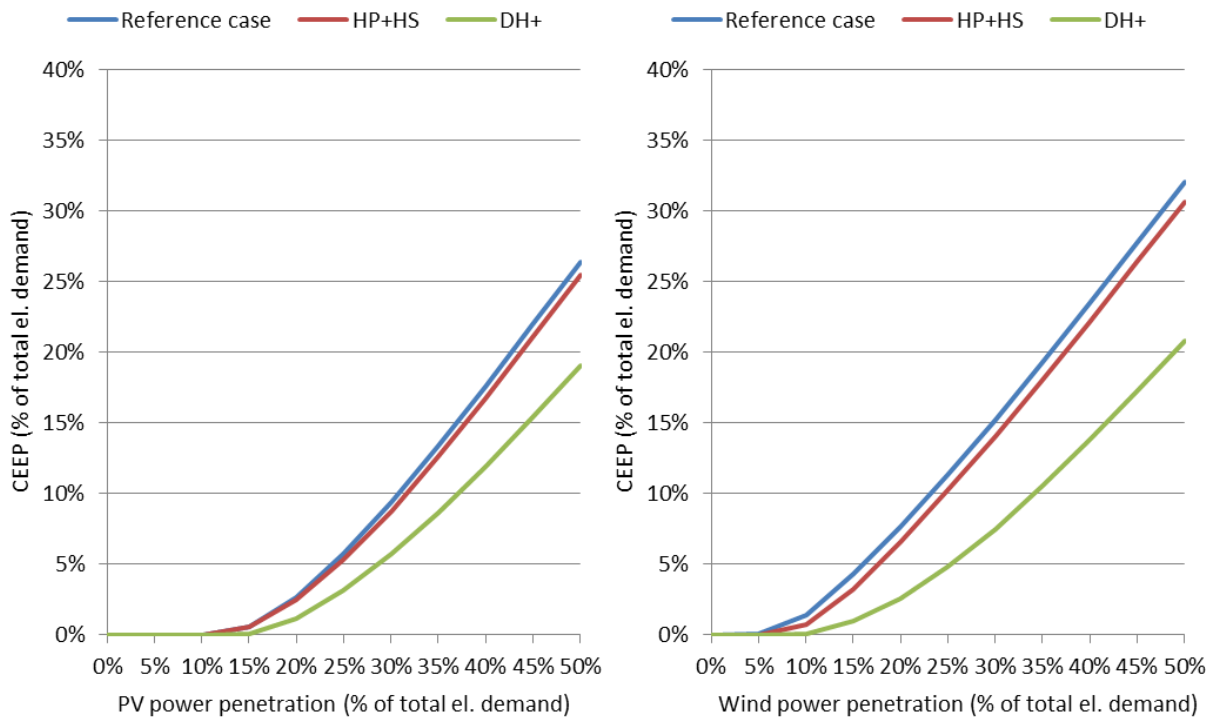


Fig. 3 Potential penetration of wind and PV power

The illustrations in Figure 3 present the Critical Excess of Electricity Productions (CEEP) in scenarios with a high penetration of PV (on the right) and wind (on the left) power. CEEP presents the amount of produced

electricity that cannot be stored or exported. It should be avoided in energy systems but a small amount can be tolerated since it is not always economically feasible to build storage capacities that will only be used in short periods of extremely high production and low demand of electricity. In order to analyze the impact DH systems have on the energy system of the city of Osijek, three separate scenarios have been developed for both wind and PV penetration (6 in total). In case of both wind and PV, the scenarios devised as the reference scenarios are those in which Osijek's energy system is recreated as it stands now with one gas operated district heating system based on a CHP unit with an electrical capacity of 89 MW and no heat storage or heat pumps. The second scenario (HP+HS) is the reference case with an addition of a heat storage system and heat pumps that should utilize CEEP and also replace the CHP units in times of low electricity demand. In the final scenario (DH+) the district heating demand was increased by 50% and the heat pumps and heat storage was also used as in the previous one.

As the results in Figure 3 show, even the installation of heat pumps and heat storage systems without the increase of the DH share have a small but positive effect on the potential penetration of wind and PV systems. If we take a look at wind penetration equaling 25% of the total electricity demand, the share of CEEP is 11.32% of the total electricity demand in the reference scenario and 10.21% in the HP+HS scenario. The increased DH demand in combination with the heat pumps and storage reduces this number further to 4.81%. A similar trend can be observed for PV. If we again take a share of 25% for PV power, CEEP equals 5.74%, 5.33% and 3.14% for the reference, HP+HS and the DH+ scenarios.

#### 4. Conclusion and future work

Within this paper a detailed heat mapping method has been presented and utilized. The method itself can be universally implemented at any location but the results of the process and its time intensity are highly dependent on the type and amount of data available. The method has been demonstrated on a case study for the city of Osijek. The developed heat maps will be calibrated and enriched with additional layers in future work. Additional information like data obtained from energy certificates, population density, sources of waste heat and the gas and DH networks will be integrated in this map making it useful for the calculation of the potential penetration of DH system in the city.

The analysis of the impact that DH systems have on the energy system as a whole have shown a reduction in CEEP of up to 35% for wind and almost 28% for PV. This demonstrates the importance DH systems have in the future large-scale integration of intermittent renewables in modern energy systems.

#### Acknowledgement

Financial support from the European Union's Intelligent Energy Europe project STRATEGO (grant agreement EE/13/650) and the 4DH project funded by the Innovation Fund Denmark are gratefully acknowledged.

#### References

- [1] European Commission, "20 20 by 2020 Europe's climate change opportunity," Brussels, 2008.
- [2] European Commission, "A Roadmap for moving to a competitive low carbon economy in 2050," Brussels, 2011.
- [3] European Environment Agency, "Annual European Union greenhouse gas inventory 1990–2012 and inventory report 2014," European Environment Agency, 2014.
- [4] H. Lund, S. Werner, R. Wiltshire, S. Svendsen, J. E. Thorsen, F. Hvelplund and B. V. Mathiesen, "4th Generation District Heating (4GDH): Integrating smart thermal grids into future sustainable energy systems," *Energy*, vol. 68, pp. 1–11, 2014.
- [5] M. Münster, P. E. Morthorst, H. V. Larsen, L. Bregnbæk, J. Werling, H. H. Lindboe and H. Ravn, "The role of district heating in the future Danish energy system," *Energy*, vol. 48, no. 1, p. 47–55, 2012.
- [6] W. Xiong, Y. Wang, B. V. Mathiesen, H. Lund and X. Zhang, "Heat roadmap China: New heat strategy to reduce energy consumption towards 2030," *Energy*, vol. 81, p. 274–285, 2015.
- [7] L. D. Lucia and K. Ericsson, "Low-carbon district heating in Sweden – Examining a successful energy transition," *Energy Research & Social Science*, vol. 4, pp. 10–20, 2014.
- [8] S. J. G. Cooper, G. P. Hammond and J. B. Norman, "Potential for use of heat rejected from industry in district heating networks, GB perspective," *Journal of the Energy Institute*, 2015.

- [9] N. Aste, M. Buzzetti and P. Caputo, “District heating in Lombardy Region (Italy): Effects of supporting mechanisms,” District heating in Lombardy Region (Italy): Effects of supporting mechanisms, vol. 14, pp. 43-55, 2014.
- [10] P. Gabillet, “Energy supply and urban planning projects: Analysing tensions around district heating provision in a French eco-district,” Energy Policy, vol. 78, p. 189–197, 2015.
- [11] A. Bolonina, G. Bolonins, D. Blumberga, “Analysis of the Impact of Decreasing District Heating Supply Temperature on Combined Heat and Power Plant Operation”, Environmental and Climate Technologies, vol14, no. 1, pp. 41-46, 2014
- [12] M. A. Ancona, L. Branchini, A. De Pascale, F. Melino, “Smart District Heating: Distributed Generation Systems’ Effects on the Network”, Energy Procedia, vol 75, pp. 1208 – 1213, 2015
- [13] M. Elci, A. Oliva, S. Herkel, K. Klein, A. Ripka, “Grid-interactivity of a solar combined heat and power district heating system”, Energy Procedia, vol 70, pp. 560 – 567, 2015
- [14] R. Mikulandrić, G. Krajačić, N. Duić, G. Khavin, H. Lund, B. V. Mathiesen, P. Østergaard, “Performance Analysis of a Hybrid District Heating System: A Case Study of a Small Town in Croatia, Journal of Sustainable Development of Energy, Water and Environment Systems, Volume 3, no. 3, pp 282-302, 2015
- [15] “EnergyPLAN,” [Online]. Available: <http://energy.plan.aau.dk/>. [Accessed 12 February 2013].
- [16] B. Čosić, G. Krajačić and N. Duić, “A 100% renewable energy system in the year 2050: The case of Macedonia,” Energy, vol. 48, no. 1, pp. 80-87, 2012.
- [17] W. Liu, H. Lund and B. V. Mathiesen, “Large-scale integration of wind power into the existing Chinese energy system,” Energy, vol. 36, no. 8, p. 4753–4760, 2011.
- [19] H. Lund and W. Kempton, “Integration of renewable energy into the transport and electricity sectors through V2G,” Energy Policy, vol. 36, no. 9, p. 3578–3587, 2008.
- [19] M. Munster and H. Lund, “Use of waste for heat, electricity and transport — Challenges when performing energy system analysis,” Energy, no. 34, pp. 636-644, 2009.
- [20] H. Lund, “Large-scale integration of optimal combinations of PV, wind and wave power into the electricity supply,” Renewable Energy, no. 31, pp. 503-515, 2006.
- [21] H. Lund and E. Munster, “Modelling of energy systems with a high percentage of CHP and wind power,” Renewable Energy, vol. 28, no. 14, pp. 2197-2193, 2003.
- [22] B. Čosić, N. Markovska, G. Krajačić, V. Taseska and N. Duić, “Environmental and economic aspects of higher RES penetration into Macedonian power system,” Applied Thermal Engineering, vol. 43, pp. 158-162, 2012.
- [23] H. Lund and B. V. Mathiesen, “Energy system analysis of 100% renewable energy systems—The case of Denmark in years 2030 and 2050,” Energy, vol. 34, no. 5, pp. 524-531, 2009.
- [24] G. Krajačić, N. Duić, Z. Zmijarević, B. V. Mathiesen, A. A. Vučinić and M. G. Carvalho, “Planning for a 100% independent energy system based on smart energy storage for integration of renewables and CO2 emissions reduction,” Applied Thermal Engineerin, vol. 31, no. 13, pp. 2073-2083, 2011.
- [25] “H2RES Model,” [Online]. Available: <http://powerlab.fsb.hr/h2res/>. [Accessed 12 February 2015].
- [26] Geoportal, [Online] Available: <http://geoportal.dgu.hr/viewer/> [Accessed 10 May 2015]
- [27] City of Osijek, “Sustainable Energy Action Plan of the City of Osijek” 2013.
- [28] HEP proizvodnja, [Online] Available: <http://www.hep.hr/proizvodnja/en/basicdata/thermal/osijek.aspx> [Accessed 10 May 2015]
- [29] ENTSO-E, “European Network of Transmission System Operators for Electricity,” 2013. [Online]. Available: <https://www.entsoe.eu/>. [Accessed 16 December 2014].
- [30] meteonorm, “Meteonorm,” 2013. [Online]. Available: [meteonorm.com](http://meteonorm.com). [Accessed 6 January 2015].



# PAPER 2

# Heat demand mapping and district heating grid expansion analysis: Case study of Velika Gorica

*Hrvoje Dorotić*<sup>1,\*</sup>, *Tomislav Novosel*<sup>1</sup>, *Neven Duić*<sup>1</sup>, and *Tomislav Pukšec*<sup>1</sup>

<sup>1</sup>Faculty of Mechanical Engineering and Naval Architecture, Department of Energy, Power Engineering and Environment, University of Zagreb, Zagreb, Croatia

**Abstract.** Highly efficient cogeneration and district heating systems have a significant potential for primary energy savings and the reduction of greenhouse gas emissions through the utilization of a waste heat and renewable energy sources. These potentials are still highly underutilized in most European countries. They also play a key role in the planning of future energy systems due to their positive impact on the increase of integration of intermittent renewable energy sources, for example wind and solar in a combination with power to heat technologies. In order to ensure optimal levels of district heating penetration into an energy system, a comprehensive analysis is necessary to determine the actual demands and the potential energy supply. Economical analysis of the grid expansion by using the GIS based mapping methods hasn't been demonstrated so far. This paper presents a heat demand mapping methodology and the use of its output for the district heating network expansion analysis. The result are showing that more than 59% of the heat demand could be covered by the district heating in the city of Velika Gorica, which is two times more than the present share. The most important reason of the district heating's unfulfilled potential is already existing natural gas infrastructure.

## 1 Introduction

European Union (EU) has recognized energy efficiency, renewable energy sources and carbon dioxide (CO<sub>2</sub>) reduction as the 3 main pillars of its energy and climate strategy. Specific targets have been appointed for the period until 2020: Europe will reduce its CO<sub>2</sub> emissions by 20%, increase the share of RES (renewable energy sources) by 20% and increase the overall energy efficiency by 20% until 2020 compared to 1990 levels [1]. According to the latest reports, EU will achieve its goals related to the CO<sub>2</sub> emission reduction and renewable energy sources share but additional efforts should be undertaken to achieve the planned increase in the energy efficiency [2]. This matter will have a crucial role in the upcoming strategy for the period 2020-2030, where additional increase of energy efficiency is planned, up to 27%. The energy sector is a key component in achieving said goals since it is responsible for 79% of the EU's greenhouse gas emissions [3]. Combined heat and power (CHP) units in a combination with the district heating and cooling (DHC) systems can maximize the exploitation of the waste heat which is currently inefficiently released in the atmosphere [4, 5]. Also, these systems have the ability of utilizing locally distributed renewable energy sources such as biomass, solar and geothermal energy which will additionally increase the CO<sub>2</sub> reduction on a local level. District heating and cooling systems will have an important role in the future energy systems with a high share of an

intermittent electricity production coming from renewable energy sources such as wind turbines and solar panels. In order to balance the grid, the excess of the electrical energy could be efficiently converted and stored as a thermal, by using storage and power-to-heat technologies, which include electrical heaters and heat pumps.

In the literature, the term "Fourth generation district heating" (4DH) is reserved for DHC systems which can tackle the problems of the future energy systems. Although 4DH implies increase of the overall thermal grid efficiency by implementing lower supply temperatures, they will also have to integrate power, thermal, gas and transport grids and at the same time utilize waste heat and renewable energy sources [5]. It was already shown that Denmark could integrate up to 50% of DH with the combination of large-scale heat pumps and heat storage thus achieving great impacts on the overall energy system [6]. The analysis in this work was mostly based around the cost of the system as a whole. Similar analyses have been conducted for other countries such as China [7], Sweden [8], UK [9], Italy [10] and France [11], among others. Project Heat Roadmap Europe proved that integration of heat savings, DH in a combination with heat pumps will result in the cheapest low-carbon heat sector in Europe [12]. Analysis of the DH and RES integration has also been carried out on a city level [13], including the comparative analysis of advanced and underdeveloped systems [14]. In addition to this, hourly optimization has been proved to

\* Corresponding author: [hrvoje.dorotic@fsb.hr](mailto:hrvoje.dorotic@fsb.hr)

be an important approach in the development of DH systems [15]. Other research has also demonstrated the positive impact of energy efficiency measures related to DH such as the reduction of the supply temperature [16], utilization of smart grids [17], renewables [18] and hybrid systems [19] and socio-economic impact for final consumer [20] for example.

GIS (Geographical Information System) mapping has already been proven as a valuable tool for the analysis of energy systems. In the STRATEGO project, the heat demand mapping methodology has been developed [22]. Apart from the energy demand, GIS based methods have also been used for the mapping of potential energy sources [23].

This work will demonstrate heat demand mapping method and present the results of the analysis of the economic potential for the DH grid expansion. As the case study for this work, the city of Velika Gorica in Croatia has been selected.

## 2 Method

The work presented in this paper can be divided in the two main steps: heat demand mapping and expansion potential analysis.

### 2.1 Heat demand mapping

Heat demand consists only of the space heating demand. In order to carry out the head demand mapping process, publicly available data was used. In this way, the developed method could be used for mapping of the heat demand in other cities and regions. The mapping process is handled in 3 steps:

- mapping of the locations and surface areas of buildings,
- identification of the building heights,
- identification of the types of buildings.

Each step contains one layer of information. Combining building's surface area, height (number of floors) and type, its overall heating demand can be acquired. The obtained results can be further complimented with the addition of several layers of information for example population density, energy certificates and so on.

### 2.2 DH expansion analysis

The analysis of the potential for the expansion of the current DH system is based on an economic assessment to check if certain areas of a city can justify the installation of the new thermal grid. In order to make this assessment, five aspects are taken into the account:

- does a DH grid already exist in the area,
- the total heat demand in the area,
- levelized cost of heat (LCOH),
- potential revenue from the supply of heat,
- cost of a new grid in the area.

According to the available data, proposed analysis can be carried out on a building level or in a grid form, as shown below. In order to calculate levelized cost of heat, method described in [21] was used. Actual heat and capacity prices were used to estimate the potential revenue.

To calculate the total cost of the DH grid expansion, two sets of data are required: the length and discounted cost of pipes. This data can be obtained by calculating the average net surface area of the buildings relative to the ground surface areas as well as the distribution length relative to the net surface area of all connected users. The calculation is shown in Equation (1).

$$L_{ng}=(L_{nu}/A_{cu})/(A_u/A_g) \quad (1)$$

Where  $L_{ng}$  represents the necessary distribution length for a given surface,  $L_{nu}$  represents the length of the existing distribution for the already connected users,  $A_{cu}$  represents the net surface area of the connected users,  $A_u$  represents the surface area of all potential users in the analysed area and  $A_g$  represents the ground surface area. The grid expansion is considered economically feasible if the total income generated by new consumers is larger than the sum of the discounted investment in the new grid and the total cost of the thermal energy production. Also, it is important to notice that the investment cost of the substations hasn't been taken into the account.

## 3 Case study

Because of the general lack of data related to the building census in Croatia, part of the process has been carried out manually. Building's location and footprint have been acquired from OpenStreetMaps (OSM) database [24] as well as the online building census GEOPORTAL [25]. Total number of floors have been collected from the city itself by using energy audits and manual inspection. This approach was also used in defining building category. In total, 7 specific heat demand categories have been used, similarly to the Sustainable Energy Action Plan (SEAP) of the city of Velika Gorica [26]:

- Households – 193 kWh/m<sup>2</sup> annually,
- Commercial buildings – 180 kWh/m<sup>2</sup> annually,
- City companies – 275 kWh/m<sup>2</sup> annually,
- Administrative buildings – 285 kWh/m<sup>2</sup> annually,
- Child care and education – 232 kWh/m<sup>2</sup> annually,
- Cultural buildings – 123 kWh/m<sup>2</sup> annually,
- Other public buildings – 128 kWh/m<sup>2</sup> annually.

Annual heat demand presented in SEAP was obtained by using the heat consumption data from the final users. Specific heat demands, shown above, don't include the the thermal energy needed for DHW preparation. The DH system Velika Gorica currently doesn't provide this service.

All of the mentioned data has been added and processed in qGIS [27], a free to use and open access GIS tool.

## 4 Results

Fig. 1 shows the heat demand map of the city with a resolution of 100 by 100 meters to demonstrate heat demand densities. This resolution has been used in all subsequent studies.

Fig. 2 shows the existing natural gas and DH distribution (existing and officially planned) within the city. As it can be seen, the gas infrastructure is spread around most of the city while DH is concentrated generally in the city centre. Normally, areas already covered by natural gas would not present suitable locations for the expansion of DH due to the competition. In this case however, gas infrastructure has been ignored in order to demonstrate the method since no expansion would be plausible if it wasn't.

Fig. 3 shows the initial results of the analysis where all

areas suitable for the exploitation of DH are shown. The analysis takes into the account the potential revenue, LCOH and cost of the DH grid expansion into consideration. In cases where DH grids already exist, the results were overridden and set as suitable regardless of the costs. Since some areas identified as suitable are dislocated from the identified centres, they were excluded. The final area deemed suitable is presented in Fig. 4.

The final results show that a total of 117,182 GWh annually could be supplied by DH. This is a significant share of the total heating demand identified in the cities SEAP which equals 197,342 GWh. In the year 2008, district heating network delivered 56,242 GWh of thermal energy to the final customers, which was equal to 28% of the total heating demand [26]. This shows a great potential for a future district heating grid expansion. Thermal energy delivered by DH could be doubled, but besides a larger network, this will also require additional upgrades of the heat production facilities.

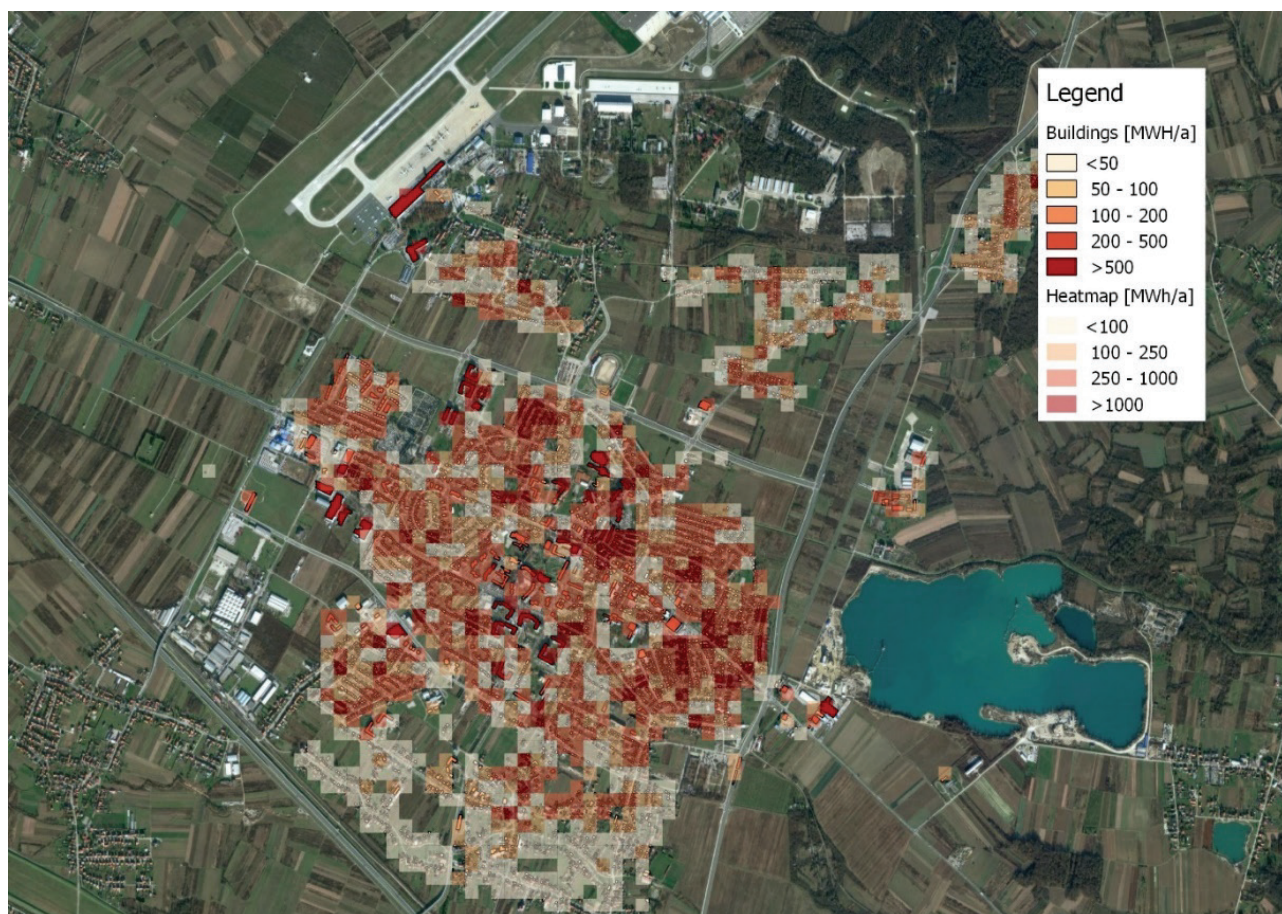
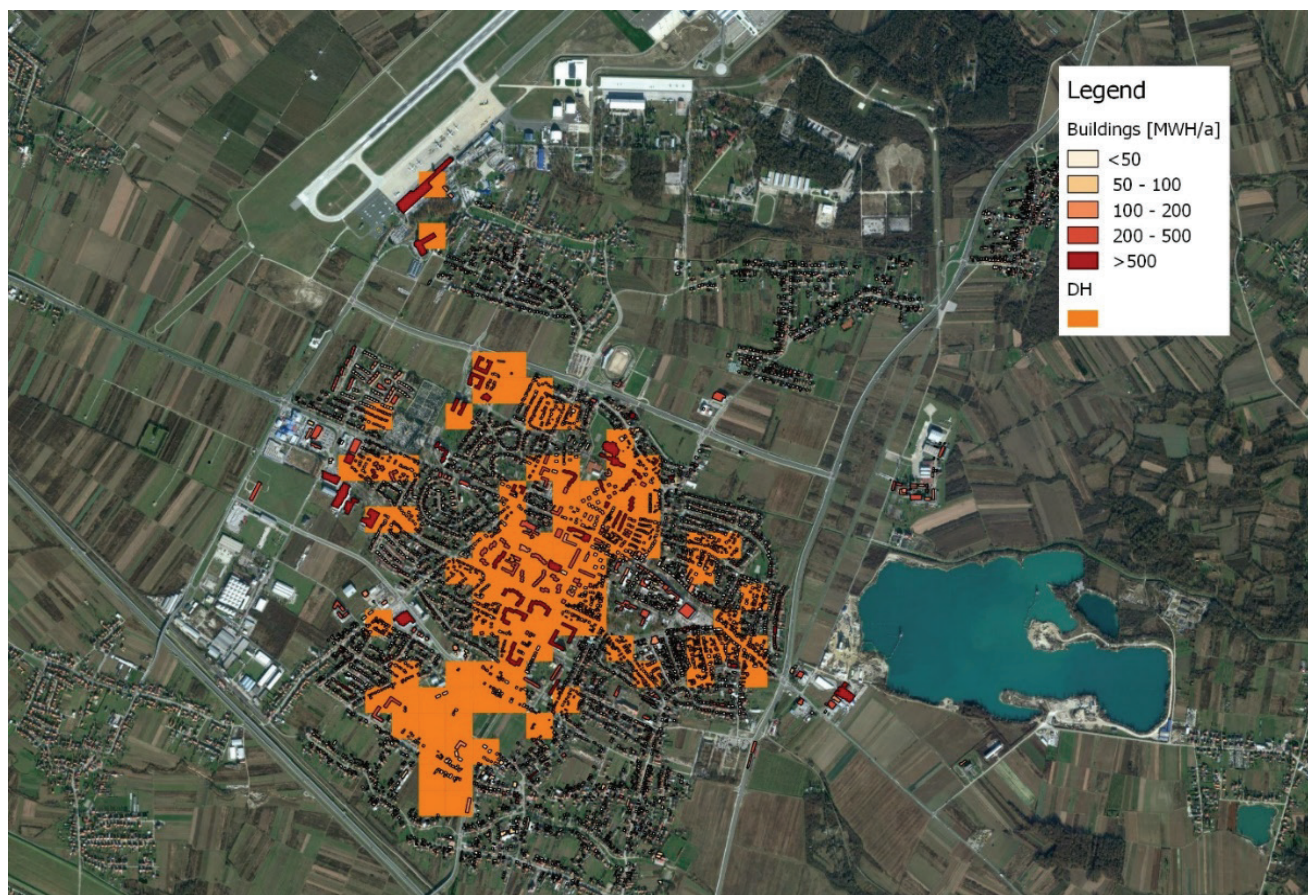


Fig. 1. Heat demand map of Velika Gorica.



**Fig. 2.** Existing infrastructure in Velika Gorica.



**Fig. 3.** Initial results.

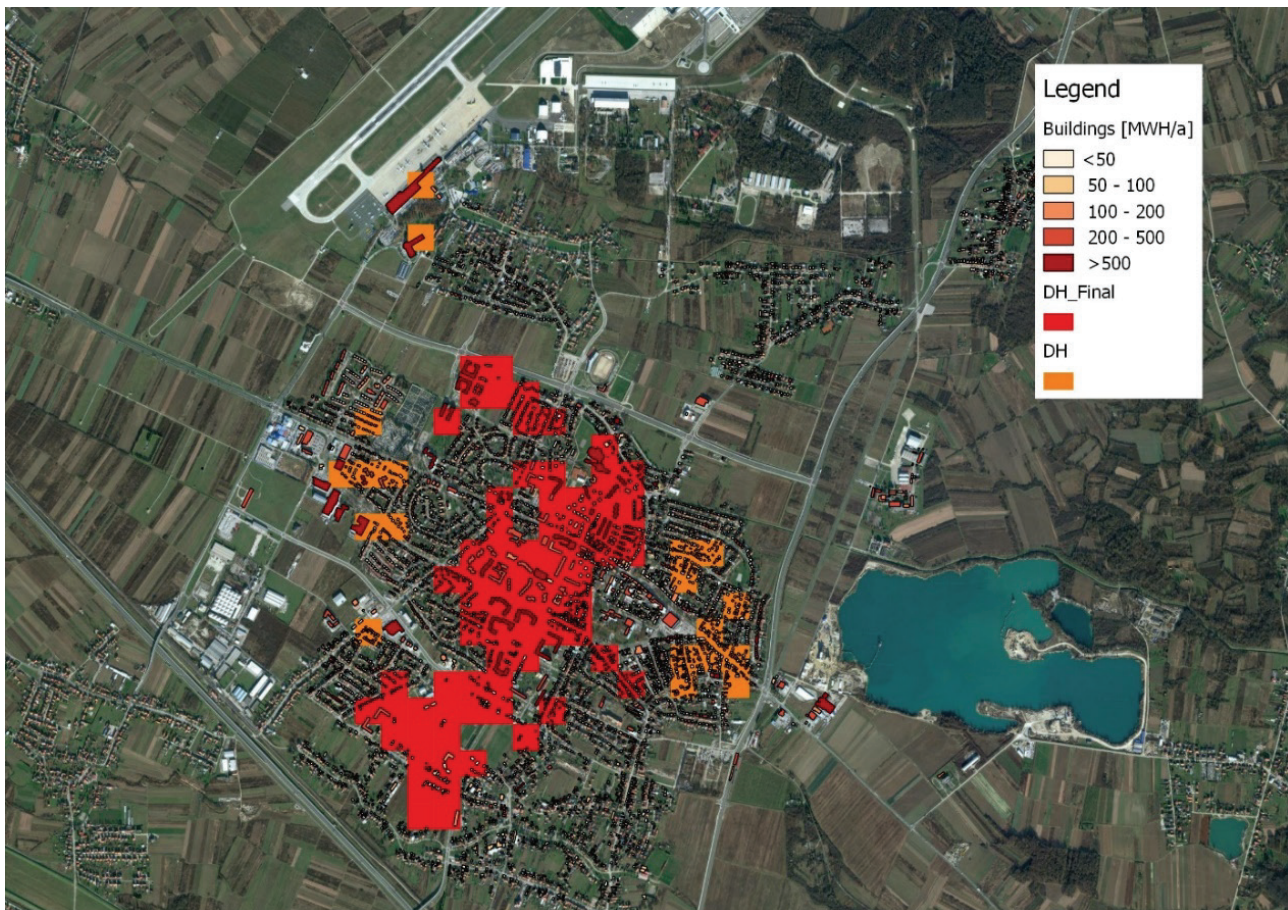


Fig. 4. Final results.

## 5 Conclusion and future work

GIS based methods have already been successfully used for energy demand and supply mapping. In this paper, mapped heat demand has been used for an analysis of the potential for the expansion of the district heating grid. As a case study, the city of Velika Gorica in Croatia has been chosen. To map the buildings and their heat demand, qGIS was used. The results have shown that a total of more than 117 GWh could be supplied from the DH which is more than 59% of the total heating demand identified in the city's SEAP. Those results can't be applied to the real case since the natural gas grid already covers large share of that area.

The future work of this research will include refinement and validation of the input data and results, including the sensitivity analysis of the used data. This will be supplemented with a supply side analysis in order to more precisely analyse the potentials for the utilization of the DH and the resulting integration of the power and heat sectors.

## Acknowledgement

Financial support from the European Union's Horizon2020 projects CoolHeating (grant agreement 691679) and PLANHEAT (grant agreement 723757), as well as the support from the RESFlex project funded by

the Environmental Protection and Energy Efficiency Fund with the support of the Croatian Science Foundation are gratefully acknowledged.

## References

1. European Commission, "20 20 by 2020 Europe's climate change opportunity," Brussels (2008)
2. European Commission, "A Roadmap for moving to a competitive low carbon economy in 2050," Brussels (2011)
3. European Environment Agency, "Annual European Union greenhouse gas inventory 1990–2012 and inventory report 2014," European Environment Agency (2014)
4. R. Lund, B. V. Mathiesen, *App. Energy* **142**, 389-395 (2015)
5. H. Lund, S. Werner, R. Wiltshire, S. Svendsen, J. E. Thorsen, F. Hvelplund and B. V. Mathiesen, 4th Generation District Heating (4GDH): Integrating smart thermal grids into future sustainable energy systems, *Energy* **68**, 1-11 (2014)
6. M. Münster, P. E. Morthorst, H. V. Larsen, L. Bregnbæk, J. Werling, H. H. Lindboe and H. Ravn, *Energy* **48**, 47–55 (2012)
7. W. Xiong, Y. Wang, B. V. Mathiesen, H. Lund and X. Zhang, *Energy* **81**, 274–285 (2015)
8. L. D. Lucia and K. Ericsson, *Energy Res. Social Sci.* **4**, 10-20 (2014)

9. S. J. G. Cooper, G. P. Hammond, J. B. Norman, Energy Inst. (2015)
10. N. Aste, M. Buzzetti, P. Caputo, Sustainable Cities and Society **14**, 43-55 (2014)
11. P. Gabillet, Energy Policy **78**, 189–197 (2015)
12. D. Connolly, H. Lund, B.V. Mathiesen, S. Werner, B. Moller, U. Persson, T. Boermans, D. Trier, P.A. Ostergard, S. Nielsen, Energy Policy **65**, 475-489 (2014)
13. T. Novosel, T. Pukšec, G. Krajačić, N. Duić, Energy Procedia **95**, 337-343 (2016)
14. D. Čulig-Tokić, G. Krajačić, B. Doračić, B. Vad Mathiesen, R. Krklec, J. Møller Larsen, Energy **93**, 435-443 (2015)
15. M. Pavičević, T. Novosel, T. Pukšec, N. Duić, Energy, **In press** (2017)
16. Bolonina, G. Bolonins, D. Blumberga, Environ. Climate Technol. **14**, 41-46 (2014)
17. M. A. Ancona, L. Branchini, A. De Pascale, F. Melino, Energy Procedia **75**, 1208-1213 (2015)
18. M. Elci, A. Oliva, S. Herkel, K. Klein, A. Ripka, Energy Procedia **70**, 560-567, (2015)
19. R. Mikulandrić, G. Krajačić, N. Duić, G. Khavin, H. Lund, B. V. Mathiesen, P. Østergaard, J. Sustain. Dev. Energy, Water and Environ. Syst. **3**, 282-302 (2015)
20. L. Grundhahl, S. Nielsen, H. Lund, B. Moller, Energy **14**, 1771-1778 (2016)
21. Levelized cost calculations, [Online]. Available: [http://en.openei.org/apps/TCDB/levelized\\_cost\\_calculations.html](http://en.openei.org/apps/TCDB/levelized_cost_calculations.html) [Accessed 05 May 2017]
22. Mapping the Heating and Cooling Demand in Europe, Work Package 2, Background report 5, STRATEGO project
23. R. Lund, U. Persson, Energy **14**, 1-10 (2016)
24. OpenStreetMaps, [Online] Available: <http://openstreetmap.org> [Accessed 10 May 2016]
25. Geoportal, [Online] Available: <http://geoportal.dgu.hr/viewer/> [Accessed 10 May 2015]
26. City of Velika Gorica, “Sustainable Energy Action Plan of the City of Velika Gorica” (2011)
27. GIS, [Online] Available: <https://qgis.org> [Accessed 03 December 2016]

# PAPER 3



# Agent based modelling and energy planning – Utilization of MATSim for transport energy demand modelling

T. Novosel<sup>1</sup>, L. Perković<sup>1</sup>, M. Ban<sup>1</sup>, H. Keko<sup>2</sup>, T. Pukšec<sup>1</sup>, G. Krajačić<sup>1</sup>, N. Duić<sup>1</sup>

<sup>1</sup>University of Zagreb; Faculty of Mechanical Engineering and Naval Architecture,  
Department of Energy, Power Engineering and Environment  
Ivana Lučića 5; 10002 Zagreb; Croatia

<sup>2</sup>Energy Institute Hrvoje Požar, Department for Energy Generation and Transformation  
Savska 163, 10001 Zagreb, Croatia

tomislav.novosel@fsb.hr

The transportation sector is one of the major energy consumers in most energy systems and a large portion of the energy demand is linked to road transport and personal vehicles. It accounted for 32.8% of the final energy consumption of Croatia in 2011 making it the second most energy demanding sector. Because of their higher efficiency, a modal switch from conventional internal combustion engines (ICE) to electric vehicles (EVs) has the potential to greatly reduce the overall energy demand of the transport sector. Our previous work has shown that a transition to EVs in a combination with a modal split from air and road to rail transport can reduce the energy consumption in Croatia by 99 PJ, which is approximately 59%, by the year 2050 when compared to the business as usual scenario. The goal of this paper is to model the hourly distribution of the energy consumption of EVs and use the calculated load curves to test their impact on the Croatian energy system. The hourly demand for the transport sector has been calculated using the agent-based modelling tool MATSim on a simplified geographic layout. The impact EVs have on the energy system has been modelled using EnergyPLAN.

Key words: Electric vehicles, Demand side modelling, Agent-based modelling, Electrification of transport, EnergyPLAN, MATSim

## 1. Introduction

The transport sector represents a serious energy consumer in most energy systems across the EU and wider. In Croatia for example, the transport sector accounted for 32.8% of the final energy consumption in 2011 making it the second most energy demanding sector right after buildings with 43% [1]. In the last decade, the final energy demand of the transport sector has increased by approximately 70% due to a verity of reasons including economic growth and large investments into a modern highway infrastructure [2]. These numbers demonstrate a large potential for energy savings related to it especially if we consider the increase in transport demand and low efficiency of standard internal combustion engines (ICE).

As it has already been demonstrated in our previous work [2], a widespread electrification of the personal vehicle fleet could reduce the total final energy demand of the transport sector in

Croatia by roughly 53% by the year 2050 when compared with a business as usual scenario. This represents a saving of 89 PJ of energy. If a modal split from road and air to rail transport is taken into account as well, this savings could be increased to 59% or 99 PJ. Other authors have already demonstrated the benefits that electrification can have on an energy system when it comes to greenhouse gas emissions [3], [4] and [5] but in order to properly assess their impact on a system as a whole an hourly analysis has to be implemented. This is necessary to accommodate for the increase of peak demand of electricity and the potential for the utilization of batteries of parked electric vehicles (EVs) as energy storage mediums that can increase the possibility for the penetration of intermittent renewable energy sources (RES). The importance of the implementation of energy storage technologies on the penetration of intermittent RES has already been discussed by several authors [6], [7] and [8].

There are a variety of approaches already available for the forecast of the annual energy demand of the transportation sector such as the ones described in [9], [10] and [11] but, as it has been already stated earlier, an hourly distribution is needed here. To accommodate for this, agent based modelling (ABM) has been utilized in the case of this work. The ABM is a relatively young area of research applied widely so there are several definitions on basic concepts. Commonly, in ABM a system is modelled as a collection of autonomous decision-making entities called agents. These entities are placed into an environment and are able to autonomously react to changes in the environment. This definition in turn implies the agents' capability of sensing the environment and effecting (actuating) in order to interact with the environment and change it [12]. In other words the agent entities are able to capture information from the environment and percept the items of acquired information, and then act accordingly. In turn, these actions affect the environment; provoking further interactions from other entities. From the paradigm viewpoint, the ABM can also be seen as microscopic, i.e. per-entity modelling, as opposed to macroscopic modelling where the integral system is being modelled. Furthermore, the separation of agents and their environment indicates the inherent distributable characteristics of ABM. Several classifications of ABM consider the environment, e.g. its observability (i.e. whether an agent can gather the complete state of the environment), or whether the environment is deterministic or stochastic etc. The definition of agent considers a certain degree of autonomy. The agents may autonomously execute various behaviours appropriate for the system they represent (e.g. purchasing, consuming, and selling). An *intelligent* agent exhibits proactiveness, reactivity and social behaviour: it is able to act towards a certain goal, it can respond to changes in the environment and it is able to interact with other agents [13]. The intelligent agent research has largely emerged from artificial intelligence and one is able to build highly complex internal structures of the agents. Generally, ABM only requires the agents to place reasonable decisions about actions to be performed. Thus even with relatively simple agent definitions, ABM can deliver repetitive and competitive interactions between agents that result in complex behaviour patterns, and this is one of key advantages of ABM: it allows the emergence of complex behaviour patterns from relatively simple per-entity models. The ABMs have been successfully used in areas ranging from economics [14] and social sciences [15] to biology and diverse engineering areas [16]. In general, when the system being modelled is complex, modular and decentralized, changeable (i.e. not statically defined), and defined at the time of design, ABM is a well-fitted method of modelling.

The Goal of this work is to model the hourly distribution of the transport energy demand and utilize that data to analyse the impact personal EVs can have on the potential for the penetration of wind and PV power in an energy system. The agent based transportation system modelling tool MATSim [17] has been used to generate said distribution and the

EnergyPLAN [18] advanced energy system analysis tool has been utilized to model Croatia's energy system and conduct the analysis.

## **2. Methodology**

The methodology of both the processes of obtaining the hourly energy demand curves for the road transport sector in MATSim and the energy system modelling in EnergyPLAN have been explained in this chapter.

### **2.1. MATSim**

In order to properly analyze the interaction between personal EVs and the electricity grid an hourly distribution of the energy demand of personal road vehicles had to be created first. As stated above, the ABM is a well-fitting method for transport modeling: there are numerous agents whose decisions and behaviours, guided by their own intrinsic rules, that by interacting among them and with the environment impact the whole transportation system on a larger scale. Furthermore the transportation system conditions are not fixed. The application of ABM in the modelling of transport is diverse. In [19] the authors present a TAPAS system for simulation of transport chains, aimed towards transport-related policy and infrastructure measures. Similarly, in [20], the authors deliver insights in the use of agent-based modelling of transport logistics. This paper focuses on the simulation of urban transport, such as the study presented in [21], where the authors present a study on driver behaviour in congested streets of the city of Brisbane. Several tools for agent-based modelling of such urban traffic exist. NISAC FastTrans [22], developed at US Los Alamos National Laboratory is a discrete, event-based simulator designed to study the impacts of infrastructure components in crisis management and dynamic prioritization. MAINSIM [23], Multimodal Inner-city Simulation Tool is a tool developed in Goethe University in Frankfurt, Germany, aimed towards using map information directly. It is an actor-based simulation system. COS-SIM [24] is an open source tool for agent-based micro simulation of traffic flows, directed primarily towards tuning of the traffic control devices.

For the simulations in this paper, MATSim [17] was chosen as a simulation tool. The MATSIM model provides a framework to implement large-scale agent-based transport simulations. It is exceptionally modular: demand modeling, mobility simulations, replanning, controller module and analysis modules are provided. These modules can be used in combination or stand-alone. The MATSIM model is open-source, cross-platform and highly customizable, since its Java source code is freely available online. Thus MATSIM offers extensibility and allows the user to add additional functionalities to its modules and tailor the MATSIM for a particular problem.

A key feature of MATSIM is agent-based, multi-modal simulation of daily mobility behaviour. The MATSIM simulations utilize behaviour definition for single persons ("agents") to track and model the system behaviour on the whole. In the case of personal EV-based mobility, the aggregated behaviour is visible as an additional electricity demand and for this reason, along with the flexibility to include the EV-related specifics, MATSIM was selected as an appropriate tool for this paper.

The MATSIM simulation architecture [17] makes it particularly suitable for policy-making issues, and it has been successfully used in tasks such as assessing the emission impact due to household travelling [25] optimizing taxi service [26], determining policies on traffic planning [27], [28] etc.

## 2.2. EnergyPLAN

EnergyPLAN is a deterministic input output computer modelling tool that creates an annual analysis of an energy system on an hourly level. It requires a wide range of input data including the total annual demands and hourly demand curves for electricity, installed capacities and efficiencies of different types of energy producers (both renewable and non-renewable) and energy storage technologies, fuel mix, hourly distribution of energy production from intermittent sources like wind, solar and small hydro, the energy demands for different sectors including transport, hourly distribution of transport energy demand, vehicle to grid connection capacities, different regulation strategies and so on. The results of the model include energy balances, annual and hourly energy production by source and the critical excess of electricity production (CEEP) present in the system, fuel consumptions by fuel type, total cost of the system, CO<sub>2</sub> emissions and so on.

EnergyPLAN is a well documented tool that specializes in the large scale integration of RES in energy systems [29] and [30], the optimal combination of RES [31] and the implementation of CHP units in energy systems [32]. It has already been used to recreate many different energy systems and devise numerous energy scenarios. For example, authors of [29] and [33] used the model to simulate different scenarios for the Macedonian energy system. In [32] and [34] EnergyPLAN has been used to model the Danish energy system and to analyze the potential for the integration of RES. The authors of [35] used both the EnergyPLAN and the H<sub>2</sub>RES [36] models to recreate the Croatian energy system and plan a 100% energy independent scenario. EnergyPLAN has already been used to analysis of the impact of the transport sector, especially electric vehicles, on an energy system [37] and [38] in the past.

## 3. Case study for Croatia

The data gathering and processing and the development of the case study for Croatia using both MATSim and EnergyPLAN has been explained here.

### 3.1. Hourly distribution of the transport energy demand

In order to create an hourly energy demand curve for the Croatian road transport sector, more precisely personal vehicles, 4 individual distributions have been created for the cities of Zagreb, Rijeka, Split and Osijek. The sum of the four curves is used to represent the distribution for Croatia.

Inputs required by the MATSim are divided into the following categories:

- population: provides agent's identification (agent ID number), age, working municipality and longitudinal and lateral coordinates of home location
- activity plan: tells agent at which location (*work, home, leisure, shopping*) they should be at the specified time
- network: provides the detailed network for each city under the consideration and only the main roads outside the city limits
- facilities (optional): provides the longitudinal and lateral coordinates of non-home locations

The quality of the solution obtained by MATSim will be closer to reality if the input data resides on real-world observations. The best possible scenario is when each single agent represents one surveyed person, but this is highly impractical and impossible to get. Therefore, input data has to rely on survey conducted among a limited number of surveyed

people and set of data that is usually available in aggregated form. In order to reduce the number of input data and simplify the preparation of MATSim inputs, the following assumptions are used:

- the only activities are home and work
- leisure is assumed to be on the same locations as work
- there are no holidays within the year

In order to find the population and activity plan inputs for the four biggest Croatian cities, the spatial distribution of *home* and *work* locations were estimated based on the socio-demographic data, available as aggregated values at the municipality level, building density per area and the official addresses of registered companies. Since the municipalities are too big to provide a sufficiently fine resolution of *home* and *work* locations, they are further divided into 200 x 200 m rectangular cells. At this resolution, the *home* and *work* locations can be found and overlaid over the road network, as presented in Figure 1 for the case study of Croatia.

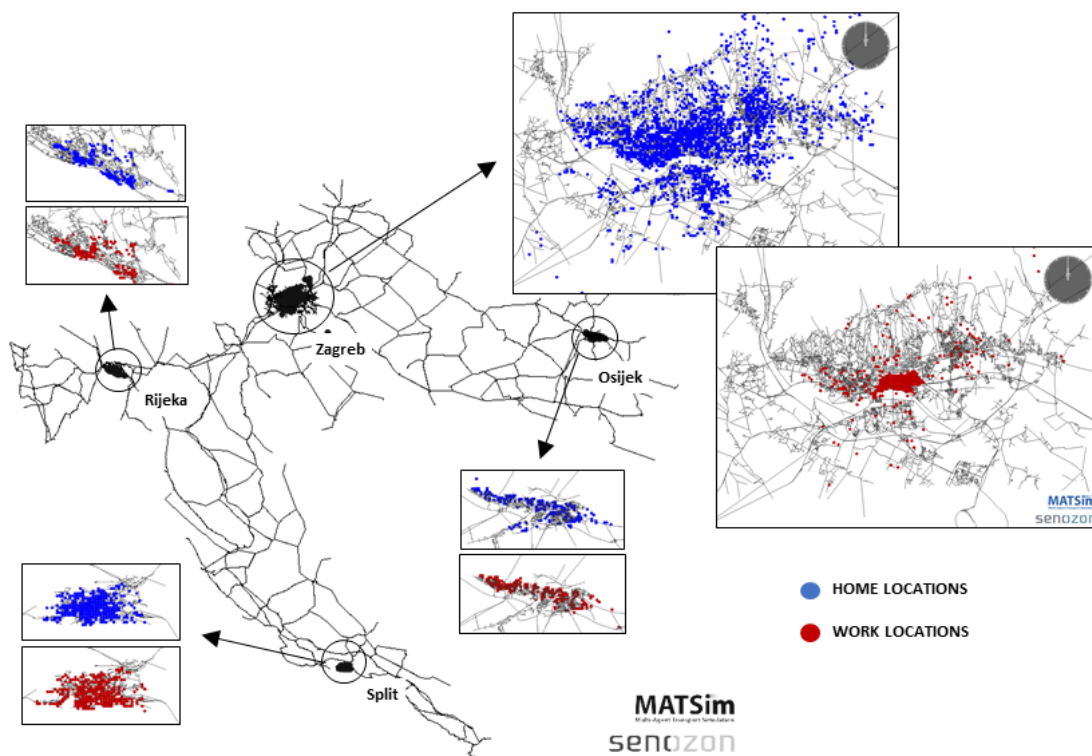


Figure 1 Network of Croatia's main roads coupled with the detailed road network in the four biggest cities overlaid with the facilities presenting agent's *home* and *work* activity locations.

Aggregated values for population and number of households for city municipalities can be found at the official web pages of each city [39], [40], [41] and [42] and boundaries of each city municipalities can be found as polygon data from Google Earth [43].

The buildings density per area is estimated from the percentage of each cell area covered by the building polygons, divided by the total area of the cell. Buildings polygon data are taken from the Geofabrik online database [44]. The addresses of companies are extracted from the Croatian Chamber of Economy (CoE) [45].

Table 1 Aggregated socio-demographic input data for Croatia's four biggest cities

	Zagreb (ZG)	Split (ST)	Rijeka (RI)	Osijek (OS)
area limits in WGS84 coordinates (estimation)	46.021N 15.534W 45.665S 16.392E	43.534N 16.382W 43.498S 16.512E	45.386N 14.3348W 45.307S 14.520E	45.584N 18.596W 45.525S 18.776E
No. of municipalities	17 [39]	27 [40]	34 [41]	15 [42]
No. of employed (2011 census) [46]	322.256	63.561	50.494	38.786
% of employed driving a car	62 [47] 77 [48]	62 <sup>(est.)</sup>	62 <sup>(est.)</sup>	62 <sup>(est.)</sup>
Estimated number of agents travelling by car	199.798	39.407	31.306	24.047

Total number of employees is provided by the Croatian Bureau of Statistics [46]. Total number of agents for each city municipality is estimated as a total number of employees multiplied by a percentage of employees having personal vehicles as a mode of transport [47].

Activity plan for each agent should provide the coordinates of each activity and their time series during the day. Activities are different for the work day or weekend. In this work, the only activities are *home* and *work*. *Home* location for each agent is found among the available cells taking into account the probability of the building density. An example for the city of Zagreb is given in Figure 2 with a resolution of 200 by 200 m.

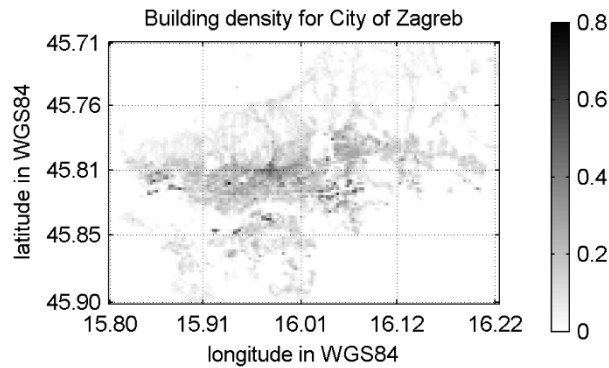


Figure 2 Distribution of the building densities in the city of Zagreb

Finding the *work* location for each agent is divided into two steps. In the first step, the municipality of the work location is found from the solution of the origin-destination (O-D) matrix, whose rows represent probabilities of work municipalities and its sum of column values corresponds to total number of registered businesses for each municipality, normalized by the total number of businesses. The O-D matrix is solved by the iterative proportional fitting (IPF) algorithm. The penalty function for the IPF procedure is the interpolation between the O-D matrix distance values between municipalities and the daily driven kilometres from the input survey [48], Fig.3. The survey has been conducted by the Energy Institute Hrvoje Požar for the city of Zagreb on a sample of 361 people. In the second step, the exact cell of the *work* location cell is found from the building density within the target municipality, by following the same procedure as in the case of finding the *home* locations.

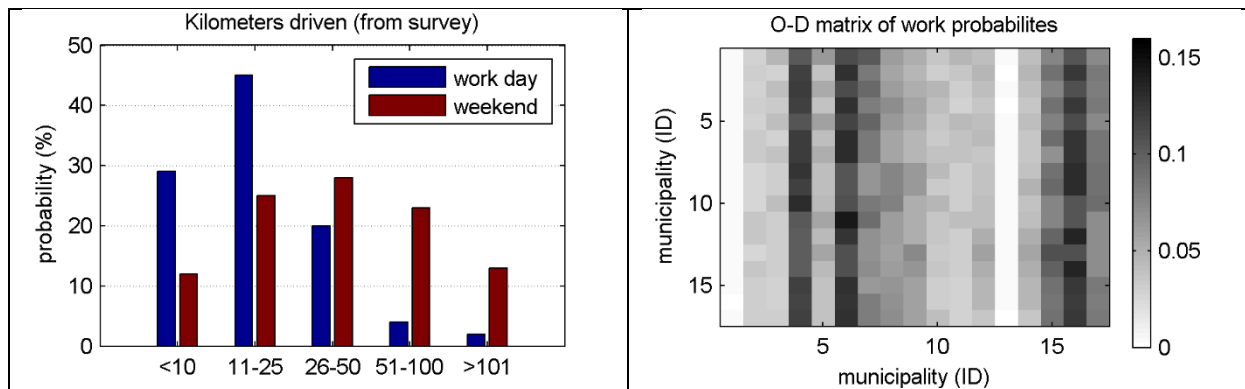


Figure 3 average daily driven kilometres obtained from the survey (left) and the resulting O-D matrix of the probabilities for work municipalities for the City of Zagreb (right)

From Figure 3 three municipalities can be recognized as municipalities with the most registered businesses, which follows directly from the CoE inputs.

Time series are constructed from the assumption that departures from the *home*, *work* and *leisure/shopping* locations follow a normal distribution. Typical distributions for the work day and the weekend are presented in Figure 4.

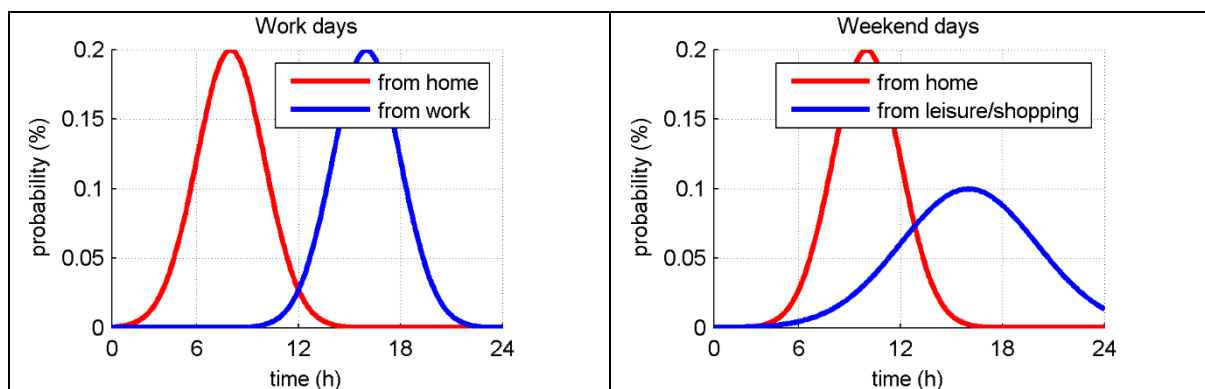


Figure 4 Time series probabilities for activities home, work and leisure/shopping for work day (left) and weekend (right)

MATSim utilizes the time series, O-D matrix and the developed transport network to generate the agent's behaviour and with that the hourly distribution curve. The difference between the input time series and output distribution is presented in Figure 5.

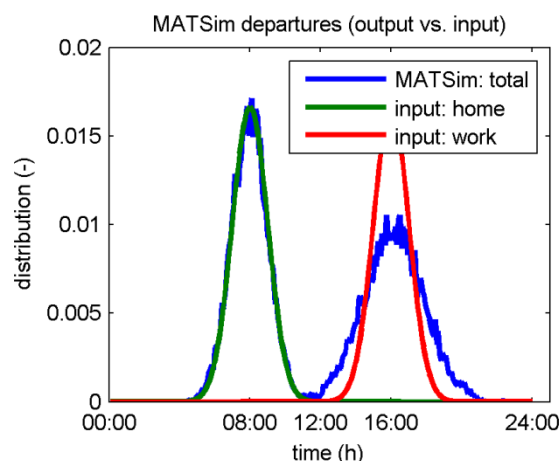


Figure 5 Difference between the input time series and output distribution

The network is extracted from the OpenStreetMap data, region Europe, sub-region Croatia, downloaded from the Geofabrik web server [44].

### 3.2. Modelling of Croatia’s energy system

In order to analyse the impact EVs have on the grid a reference model of Croatia’s energy system has been created in EnergyPLAN. As it has already been mentioned, EnergyPLAN requires a wide variety of inputs. The fuel mix of the large thermal power plants as well as the energy use of the individual sectors has been adopted from the International Energy Agencies (IEA) web site [49]. The hourly electricity load has been taken from the web site of the European Network of Transmission System Operators for Electricity [50]. Meteorological data including global insolation and wind speeds have been taken from Meteonorm [51] and used to calculate the hourly production from wind power and PV. The obtained annual figures were then compared with the data available on the IEA website [49]. These data is presented below in Table 2. The installed capacities of the installed power plants have been taken from [1] and [52] and the statistical information related to the number of personal vehicles from [53]. A minimal grid stabilization share, the minimum production of electricity from power plants capable of providing ancillary services in relation to the total production of electricity, has been set to 30% in all scenarios. The minimal capacity of thermal power plants (PP min) of 42% has been assumed. The technical regulation strategy number 2 has been used “Balancing both heat and power demands”. The impact of different optimisation criteria on energy systems has been discussed in [54] in great detail. The CO<sub>2</sub> content of the different fuels has been taken from [33].

In order to validate the created scenario, several parameters calculated by EnergyPLAN have been compared to the ones listed on the IEA web site. Table 2 presents the comparison of the results obtained from EnergyPLAN and the data from the IEA [49]. As the table shows, there is a difference of 3.5% between the calculated CO<sub>2</sub> emissions and the ones listed by the IEA. This is due to the emission factors that the IEA uses. The electricity production from fossil fuels, hydro and renewables is almost identical for both cases. The great difference between the electricity produced from nuclear energy and the import and export of electricity is due to the way the IEA regards the nuclear power plant in Krško, Slovenia. It is partially owned by Croatia and partially by Slovenia but since it is located outside of Croatia’s borders, the electricity it produces and distributes to Croatia is regarded as import. If we add up the electricity generated by it with the electricity import and export, the resulting values are almost identical.

Table 2 Validation of the EnergyPLAN model

	EnergyPLAN	Iea.org [49]
Total CO <sub>2</sub> emissions	18.11 Mt	18.77 Mt
Electricity produced from fossil fuels	6.00 TWh	6.01 TWh
Electricity produced from hydro energy	4.63 TWh	4.62 TWh
Electricity produced from renewables	0.20 TWh	0.201 TWh
Electricity produced from nuclear	2.97 TWh	0 TWh
Electricity import	4.73 TWh	8.730 TWh
Electricity export	0.01 TWh	1.033 TWh
Import – export + nuclear	7.69 TWh	7.697 TWh



## 4. Results

### 4.1. MATSim results

Results obtained from MATSim are time series of kilometres that vehicles travel for each day of the week for each of the four cities taken into consideration, Figure 6.

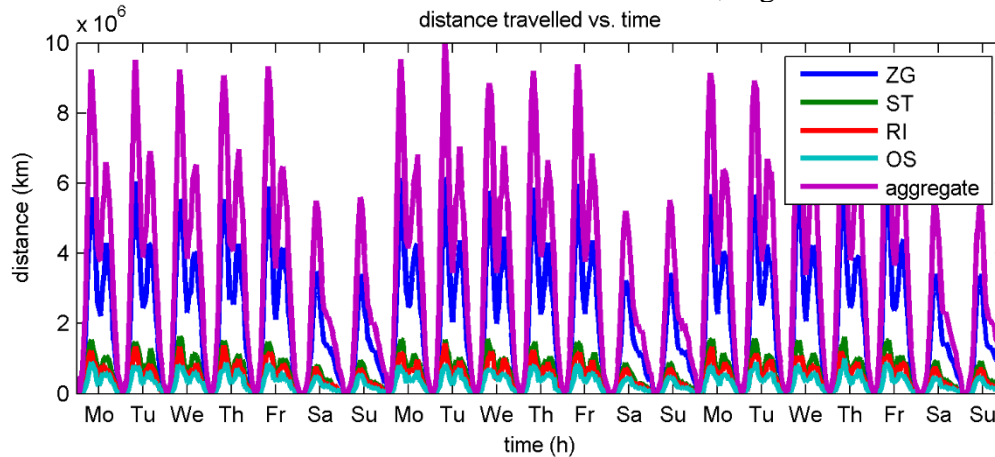


Figure 6 Output from MATSim: time series of kilometres driven for three weeks

The time series of travelled distance is strongly following the time series of prescribed activities. The city of Zagreb is the most dominant in the aggregated value.

### 4.2. EnergyPLAN results

In order to analyze the impact of EVs on Croatia's energy system, 12 scenarios have been devised. The first 6 scenarios analyse the potential for the penetration of wind power for a baseline scenario with EVs and 5 scenarios with EV penetration of 10%, 20%, 30%, 40% and 50%. The second set of 6 scenarios analyse the same scenarios but for PV penetration. The wind and PV penetrations are varied from 0% to 50% of the total electricity demand (excluding EVs), meaning that the production of electricity from wind or PV equals 0% to 50% of the total electricity demand excluding EVs, with a step of 5%.

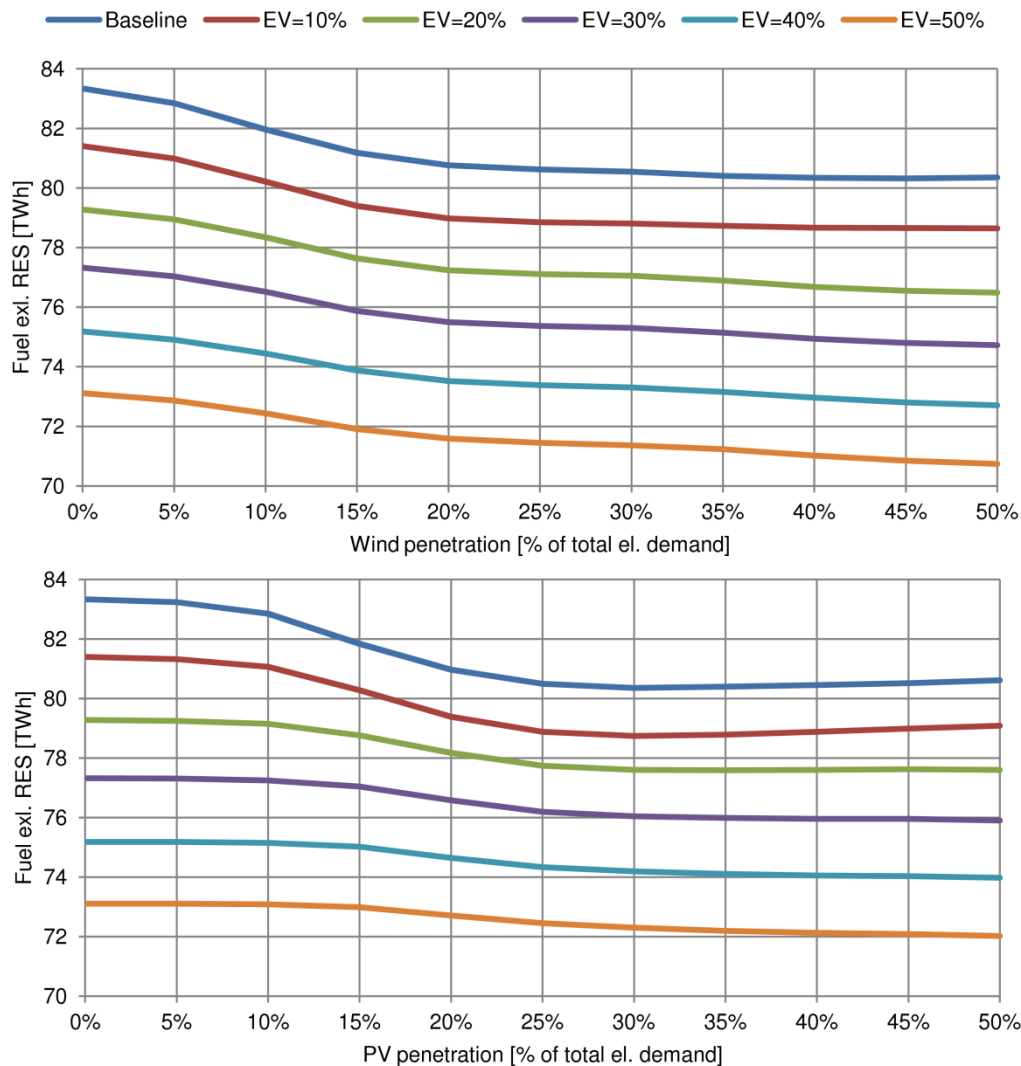


Figure 7 Fuel consumption excluding RES for scenarios with wind (top) and PV (bottom)

Figure 7 presents the total fuel consumption excluding RES for the six scenarios with wind (top figure) and PV (bottom figure). As it is expected, the scenarios with a higher penetration of RES have lower fuel consumption and the increase in the penetration of EVs also has a positive effect on its reduction. This is primarily due to the fact that EVs are considerably more efficient, upwards of 300% more in some cases, but also because the increase of their penetration presents a storage capacity for excess electricity and thus can increase the potential for the penetration of intermittent RES like wind and PV. In this work the average efficiency of vehicles with ICEs was presumed to be 1.5 km/kWh and for EVs 5 km/kWh. A 50% share of EVs can reduce the total fuel consumption of the whole system (including all sectors not just energy and transport) from the base value of 83.34 TWh to 73.11 TWh which is a difference of 10.23 TWh or 12.3%. Higher penetrations of RES do not have a significant impact on the reduction of fuel consumption; in the baseline scenario a 50% penetration of wind power reduces the total fuel consumption from the base value of 83.34 TWh to 80.35 TWh, a difference of merely 3.5%. The results are fairly similar for PV with a reduction of 3.26%. This is true because of the high dependence on imported electricity which doesn't register as fuel consumption. When such import is replaced with electricity from RES, fuel consumption of the system stays almost unchanged.

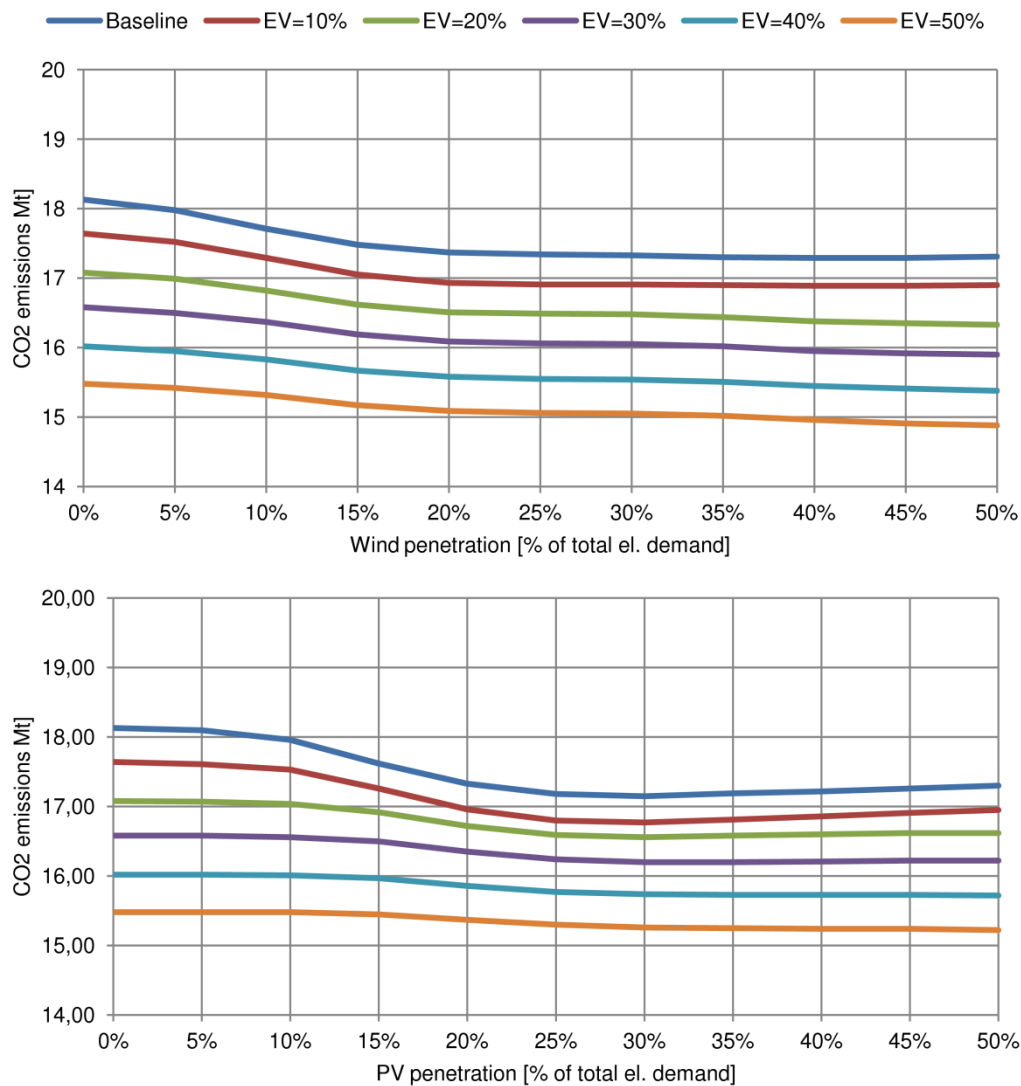


Figure 8 CO<sub>2</sub> emissions for scenarios with wind (top) and PV (bottom)

Figure 8 presents the annual CO<sub>2</sub> emissions for the six scenarios with wind (top figure) and PV (bottom figure). The data on the figures closely follow the trend of the fuel consumption presented in Figure 7, which is to be expected. A 50% share of EVs has reduced the total annual CO<sub>2</sub> emissions of the whole energy system, again including all sectors, from the initial value of 18.13 Mt to 15.48 Mt, a reduction of 14.6% in the presented scenarios. Again, similar to the results presented in the previous figure, the penetration of RES doesn't affect the CO<sub>2</sub> emissions significantly for the same reason it doesn't influence fuel consumption. Both for a wind and for a PV penetration of 50% the total CO<sub>2</sub> emissions are reduced to 17.3 Mt, a reduction of 4.6%.

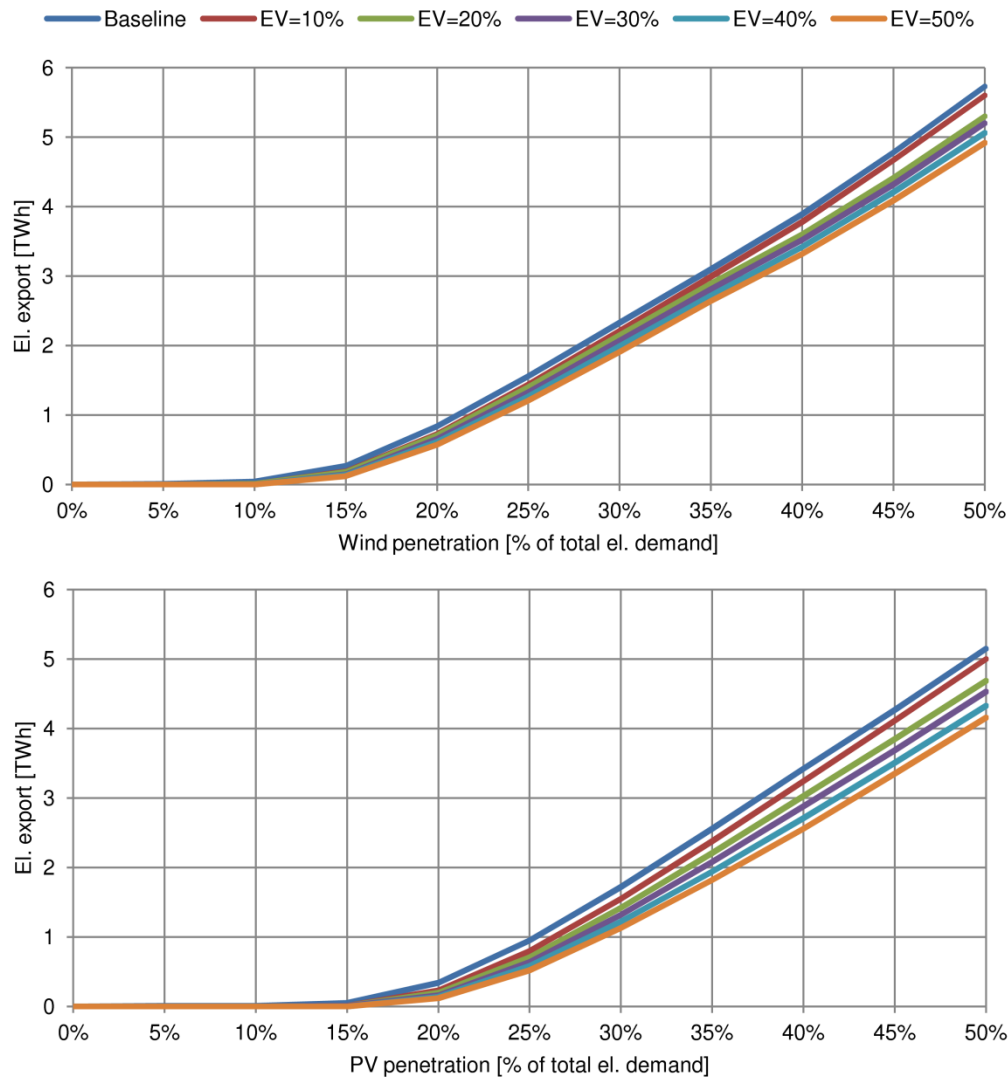


Figure 9 Export of electricity for scenarios with wind (top) and PV (bottom)

Figure 9 presents the total annual export of electricity, again for the scenarios with wind (top figure) and PV (bottom figure). It can be observed from the figures that a penetration of wind higher than 10% or PV higher than 15% will force the system to export some electricity. In the case of the scenarios that include wind power, its penetration of 15% with no EVs resulted in the export of 0.27 TWh, or 0.12 TWh for an EV share of 50%. In the case of a 50% wind power penetration the figures go up to 5.73 TWh with no EVs and 4.92 TWh with an EV share of 50%. The results are similar for the scenarios with PV, although the export is somewhat reduced. For the case of a PV penetration of 15% and no EVs, the electricity export equals 0.05 TWh. There is no export present in the same case but with a 50% share of EVs. For a PV penetration of 50% and no EVs, the electricity export equals 5.15 TWh and 4.16 TWh for an EV share of 50%. The difference in the exported electricity for a scenario with 50% wind penetration with no EVs and with 50% EVs is 0.81 TWh or roughly 4.4% of the total electricity demand, excluding EVs, of Croatia in the year 2011. In the case of PV the same difference is 0.99 TWh or roughly 5.3% of the total electricity demand excluding EVs.

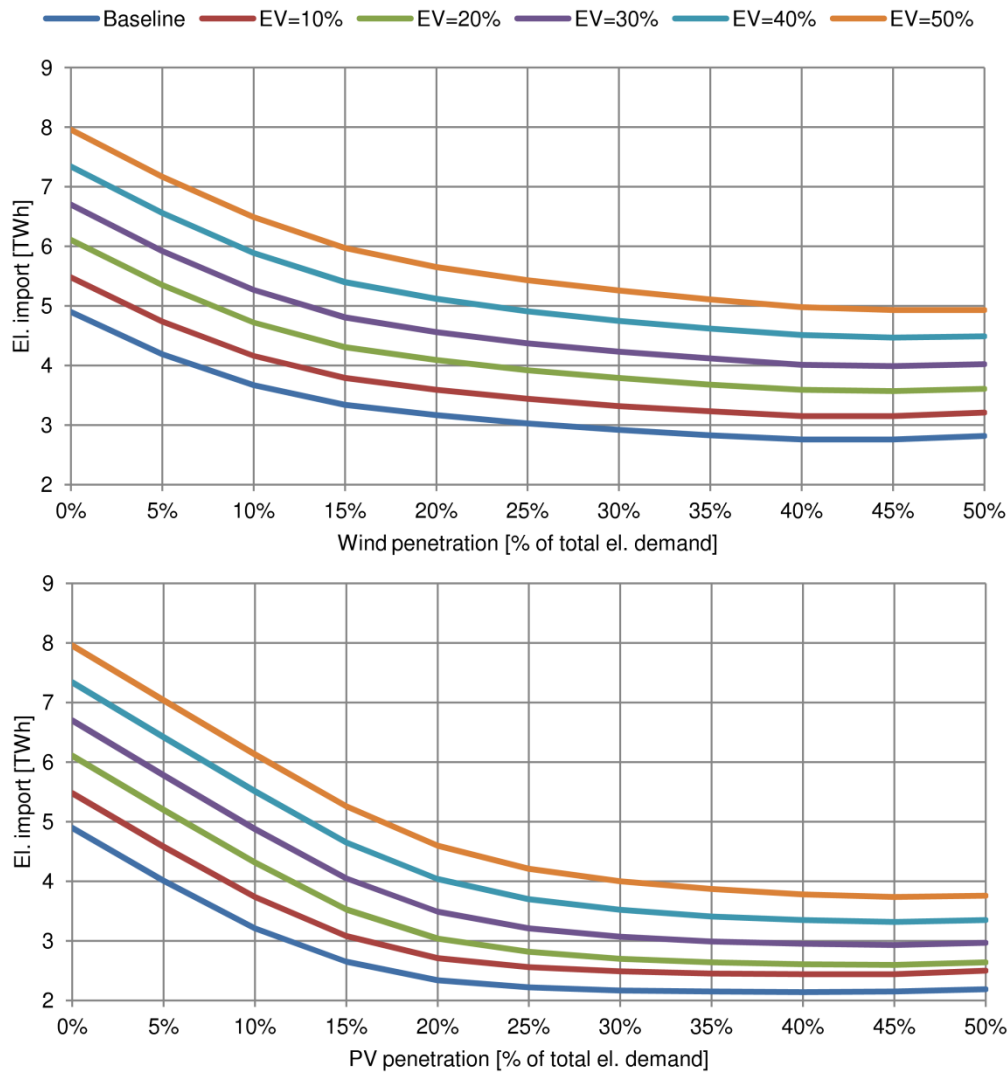


Figure 10 Import of electricity for scenarios with wind (top) and PV (bottom)

Figure 10 presents the total annual import of electricity for the scenarios with wind power (top figure) and PV (bottom figure). Since Croatia already imports a significant amount of electricity every year, 8.73 TWh in the year 2011 which is equal to 47% of the total electricity demand of that year [49], the additional demand posed by the EVs would naturally increase these values. This is evident from the presented figures. A 50% share of EVs increased the necessary import of electricity from the base value of 4.9 to 7.96 TWh.

## 5. Sensitivity analysis

In order to determine the impact that the detailed analysis of the transport demand has on the energy planning results a sensitivity analysis has been conducted comparing the hourly distribution obtained using MATSim, presented by Figure 6, and a constant distribution. CEEP has been compared for the two curves for three different penetrations of EVs (10, 30 and 50%) and for a wind power penetration ranging from 30% to 50% with a step of 5%. Wind power penetrations below 30% are not analysed since CEEP is always 0 for these case in the created scenarios. The results of the sensitivity analysis have been presented in Table 3.

Table 3 Results of the sensitivity analysis

Wind	EV=10%		EV=30%		EV=50%	
	MATSim	Constant	MATSim	Constant	MATSim	Constant
30%	0%	0%	0%	0%	0%	0%
35%	8%	8%	2%	2%	0%	1%
40%	33%	33%	15%	17%	9%	11%
45%	77%	78%	49%	53%	36%	42%
50%	132%	133%	98%	104%	81%	90%

As the results in Table 3 demonstrate, the difference for a low penetration of EVs is very small between the generated distribution curve and a constant line. For an EV penetration of 10% the difference between the two distributions is only about 1%. The difference becomes much more significant at 30% and 50% EV penetration. For 30% the difference varies from 6% to 12% and for 50% it varies from 10% to 18%.

## 6. Conclusion

Agent based modelling can be a strong tool for the modelling of the hourly distribution of energy demand of the transport sector. As it has already been stated, the quality of the results of the modelling will be highly dependent on the quality of the inputs.

The obtained hourly energy demand curves for the Croatian road transport sector has been used in the EnergyPLAN tool to analyse the impact of electric vehicles on Croatia's energy system and the potential for the increase of the penetration of wind power and PV. The results have shown that the electrification of the road transport sector can help reduce the fuel consumption by 12.3% and CO<sub>2</sub> emissions by 14.6% for the case of no renewables and a 50% share of electric vehicles. These numbers are even greater when higher penetrations of renewables are taken into account. A conducted sensitivity analysis has shown that the hourly distribution of the EV demand can have a strong influence on the obtained results at high levels of EV and intermittent RES penetration. In our case the difference in CEEP was up to 18% between the distribution generated using MATSim and a constant demand.

Future work related to this paper will include the development and utilization of a detailed survey aimed at the energy consumption of personal transport and the validation and further refinement of the obtained distributions.

## Acknowledgment

The authors are grateful for support by the Croatian Science Foundation for financing this work through the project iRESEV (no. 09/128).

## Bibliography

- [1] B. Vuk, S. Vukman, M. Karan, R. Fabek, S. Živković, M. Maričević, T. Baričević, S. Antešević, J. M. Abramović, N. Karadža, T. Borković, V. Krstulović and Ž. Jurić, "Annual Energy Report: Energy in Croatia 2011," Energy Institute Hrvoje Požar, Zagreb, 2012.

- [2] T. Pukšec, G. Krajačić, Z. Lulić, B. V. Mathiesen and N. Duić, “Forecasting long-term energy demand of Croatian transport sector,” *Energy*, vol. 57, pp. 169-176, 2013.
- [3] M. Sorrentino, G. Rizzo and L. Sorrentino, “A study aimed at assessing the potential impact of vehicle electrification on grid infrastructure and road-traffic green house emissions,” *Applied Energy*, vol. 120, pp. 31-40, 2014.
- [4] M. Sugiyama, “Climate change mitigation and electrification,” *Energy Policy*, vol. 44, pp. 464-468, 2012.
- [5] O. Bahn, M. Marcy, K. Vaillancourt and J.-P. Waaub, “Electrification of the Canadian road transportation sector: A 2050 outlook with TIMES-Canada,” *Energy Policy*, vol. 62, pp. 593-606, 2013.
- [6] R. Segurado, G. Krajačić, N. Duić and L. Alves, “Increasing the penetration of renewable energy resources in S. Vicente, Cape Verde,” *Applied Energy*, vol. 88, pp. 466-472, 2011.
- [7] G. Krajačić, N. Duić, Z. Zmijarević, B. V. Mathiesen, A. A. Vučinić and M. d. G. Carvalho, “Planning for a 100% independent energy system based on smart energy storage for integration of renewables and CO2 emissions reduction,” *Applied Thermal Engineering*, vol. 31, pp. 2073-2083, 2011.
- [8] D. Connolly, H. Lund, B. Mathiesen, E. Pican and M. Leahy, “The technical and economic implications of integrating fluctuating renewable energy using energy storage,” *Renewable Energy*, vol. 43, pp. 47-60, 2013.
- [9] Z. WooGeem, “Transport energy demand modeling of South Korea using a rtificial neural network,” *Energy Policy*, vol. 39, p. 4644–4650, 2011.
- [10] M. Zhang, H. Mu, G. Li and Y. Ning, “Forecasting the transport energy demand based on PLSR method in China,” *Energy*, vol. 34, p. 1396–1400, 2009.
- [11] J. Anable, C. Brand, M. Tran and N. Eyre, “Modelling transport energy demand: A socio-technical approach,” *Energy Policy*, vol. 41, pp. 125-138, 2012.
- [12] M. Wooldridge, *An Introduction to MultiAgent Systems*, London: John Wiley & Sons, 2009.
- [13] S. Russell and P. Norvig, *Artificial Intelligence: A Modern Approach*, New Jersey: Upper Saddle River, 2009.
- [14] L. Tesfatsion and K. Judd, “Agent-Based Computational Economics: A Constructive Approach to Economic Theory,” in *Handbook of Computational Economics*, 2006, p. 831–880.
- [15] R. Axelrod and L. Tesfatsion, “On-Line Guide for Newcomers to Agent-Based Modeling in the Social Sciences,” 2014. [Online]. Available: [www2.econ.iastate.edu/tesfatsi/abmread.htm](http://www2.econ.iastate.edu/tesfatsi/abmread.htm). [Accessed 02 December 2014].
- [16] M. Dorigo, “Swarm Intelligence,” 2014. [Online]. Available: <http://www.springer.com/computer/ai/journal/11721>.
- [17] MATSim, “Agent-Based Transport Simulations|MATSim,” 2012. [Online]. Available: <http://www.matsim.org/>. [Accessed 16 November 2013].
- [18] EnergyPLAN, “EnergyPLAN|Advanced Energy Systems Analysis Tool,” Department of Development and Planning, Aalborg University, [Online]. Available: <http://www.energyplan.eu/>. [Accessed 21 October 2013].
- [19] J. Holmgren, P. Davidsson, J. A. Persson and L. Ramstedt, “TAPAS: A multi-agent-based model for simulation of transport chains,” *Simulation Modelling Practice and Theory*, vol. 23, pp. 1-18, 2012.

- [20] P. Davidsson, L. Henesey, L. Ramstedt, J. Törnquist and F. Wernstedt, "An analysis of agent-based approaches to transport logistics," *Transportation Research Part C: Emerging Technologies*, vol. 13, no. 4, p. 255–271, 2005.
- [21] H. Dia, "An agent-based approach to modelling driver route choice behaviour under the influence of real-time information," *Transportation Research Part C: Emerging Technologies*, vol. 10, no. 5-6, pp. 331-349, 2002.
- [22] LANL, "FastTrans: Transportation Simulator," 2014. [Online]. Available: <http://www.lanl.gov/programs/nisac/fasttrans.shtml>. [Accessed 8 January 2014].
- [23] MAINSIM, "MAINSIM – MultiModal Intercity Street Traffic Simulator," [Online]. Available: <http://www.mainsim.de/?lang=en>. [Accessed 8 January 2014].
- [24] COS-SIM. [Online]. Available: <https://code.google.com/p/cos-sim/>. [Accessed 6 January 2014].
- [25] M. Hatzopoulou, J. Y. Hao and E. J. Miller, "Simulating the impacts of household travel on greenhouse gas emissions, urban air quality, and population exposure," *Transportation*, vol. 38, p. 871–887, 2011.
- [26] M. Maciejewski and K. Nagel, "Simulation and optimization of taxi services in MATSim," in *VSP Working Paper*, Berlin, 2013.
- [27] J. W. Joubert, P. J. Fourie and K. W. Axhausen, "Large-Scale Agent-Based Combined Traffic Simulation of Private Cars and Commercial Vehicles," *Transportation Research Record*, vol. 2168, pp. 24-32, 2010.
- [28] W. Gao, M. Balmer and E. J. Miller, "Comparisons between MATSim and EMME/2 on the Greater Toronto and Hamilton Area Network," *Journal of the Transportation Research Board*, vol. 2197, pp. 118-128, 2010.
- [29] B. Ćosić, G. Krajačić and N. Duić, "A 100% renewable energy system in the year 2050: The case of Macedonia," *Energy*, vol. 48, no. 1, pp. 80-87, 2012.
- [30] W. Liu, H. Lund and B. V. Mathiesen, "Large-scale integration of wind power into the existing Chinese energy system," *Energy*, vol. 36, no. 8, p. 4753–4760, 2011.
- [31] H. Lund, "Large-scale integration of optimal combinations of PV, wind and wave power into the electricity supply," *Renewable Energy*, no. 31, pp. 503-515, 2006.
- [32] H. Lund and E. Munster, "Modelling of energy systems with a high percentage of CHP and wind power," *Renewable Energy*, vol. 28, no. 14, pp. 2197-2193, 2003.
- [33] B. Ćosić, N. Markovska, G. Krajačić, V. Taseska and N. Duić, "Environmental and economic aspects of higher RES penetration into Macedonian power system," *Applied Thermal Engineering*, vol. 43, pp. 158-162, 2012.
- [34] H. Lund and B. V. Mathiesen, "Energy system analysis of 100% renewable energy systems—The case of Denmark in years 2030 and 2050," *Energy*, vol. 34, no. 5, pp. 524-531, 2009.
- [35] G. Krajačić, N. Duić, Z. Zmijarević, B. V. Mathiesen, A. A. Vučinić and M. G. Carvalho, "Planning for a 100% independent energy system based on smart energy storage for integration of renewables and CO2 emissions reduction," *Applied Thermal Engineerin*, vol. 31, no. 13, pp. 2073-2083, 2011.
- [36] "H2RES Model," [Online]. Available: <http://powerlab.fsb.hr/h2res/>. [Accessed 12 February 12].
- [37] H. Lund and W. Kempton, "Integration of renewable energy into the transport and electricity sectors through V2G," *Energy Policy*, vol. 36, no. 9, p. 3578–3587, 2008.
- [38] M. Munster and H. Lund, "Use of waste for heat, electricity and transport — Challenges



- when performing energy system analysis,” *Energy*, no. 34, pp. 636-644, 2009.
- [39] “City of Zagreb official pages,” [Online]. Available: <http://www.zagreb.hr/default.aspx?id=12915>. [Accessed 01 05 2014].
- [40] “City of Split official pages,” [Online]. Available: <http://www.split.hr/Default.aspx?sec=376>. [Accessed 01 05 2014].
- [41] “City of Rijeka official pages,” [Online]. Available: <http://www.rijeka.hr/mo>. [Accessed 01 05 2014].
- [42] “City of Osijek official pages,” [Online]. Available: <http://www.osijek.hr/index.php/cro/Mjesna-samouprava/Mjesni-odbori-i-gradske-cetvrti>. [Accessed 01 05 2014].
- [43] “Google Earth official,” [Online]. Available: <http://www.google.com/earth/>. [Accessed 01 05 2014].
- [44] “Geofabrik OpenStreetMap data (Europe),” [Online]. Available: <http://download.geofabrik.de/europe.html>. [Accessed 01 05 2014].
- [45] “Croatian Chamber of Economy official pages,” [Online]. Available: <http://www.hgk.hr/>. [Accessed 02 05 2014].
- [46] “Croatian Bureau of Statistics,” [Online]. Available: <http://www.dzs.hr/>. [Accessed 01 05 2013].
- [47] F. Foundation for the Automobile and Society, “The Automobile and Society”.
- [48] “Strategija razvoja energetske infrastrukture za napajanje električnih vozila na području Grada Zagreba,” EIHP, Zagreb, 2013.
- [49] IEA, “International Energy Agency,” 2013. [Online]. Available: [www.iea.org](http://www.iea.org). [Accessed 8 January 2013].
- [50] ENTSO-E, “European Network of Transmission System Operators for Electricity,” 2013. [Online]. Available: <https://www.entsoe.eu/>. [Accessed 16 December 2013].
- [51] meteonorm, “Meteonorm,” 2013. [Online]. Available: [meteonorm.com](http://meteonorm.com). [Accessed 6 January 2014].
- [52] HEP, “HEP Group,” [Online]. Available: <http://www.hep.hr/hep/publikacije/godisnje/2011godisnje.pdf>. [Accessed 16 December 2013].
- [53] DZS, “Statistical Yearbook of the Republic of Croatia,” Croatian Bureau of Statistics, Zagreb, 2012.
- [54] P. A. Østergaard, “Reviewing optimisation criteria for energy systems analyses of renewable energy integration,” *Energy*, vol. 34, no. 9, p. 1236–1245, 2009.

# PAPER 4

# Heat demand mapping and district heating assessment in data-poor areas

Novosel, T.<sup>1,\*</sup>, Pukšec, T.<sup>2</sup>, Duić, N.<sup>2</sup>, Domac, J.<sup>1</sup>

1=North-West Croatia Energy Agency, Andrije Žaje 10, 10000 Zagreb

2=University of Zagreb; Faculty of Mechanical Engineering and Naval Architecture, Department of Energy, Power Engineering and Environment, Ivana Lučića 5, 10002 Zagreb; Croatia

\* = corresponding author details, [tnovosel@regea.org](mailto:tnovosel@regea.org)

## Abstract

Buildings represent 40% of the European Union's energy consumption and 36% of its greenhouse gas emissions making it obvious that the decarbonisation of the European Union depends on the sustainable provision of heat in its cities. District heating presents it self as a clear solution to this issue. It is capable of supplying waste and renewable heat from where it is available to where it is needed and can provide a powerful driver for the integration of renewables in the electrical system through the flexibility that power to heat technologies can provide. Due to the inability of long-distance transport of heat, spatial planning and GIS mapping has proven to be a very important tool in heat planning. This usually requires a lot of highly detailed data which is often not available. The research presented in this paper is tackling this issue through a heat demand mapping and district heating viability assessment method using mostly public databases. The developed method consists of three key steps: assessment of the aggregated heating demand, bottom up mapping used for validation and top down mapping of the entire observed area. The result of the mapping is used in the assessment of the district heating potential based on the difference between the price and levelized cost of heat as well as the assumed cost of the distribution infrastructure. The method has been implemented on the case of Croatia showing a significant potential for the economic utilisation of district heating.

## Highlights:

- Heat mapping is an important tool for energy planning, but it is data intensive
- A flexible heat mapping and district heating assessment method has been developed
- Combination of aggregated assessment, bottom up and top down mapping
- Assessment based on the price of heat and the levelized cost of its production
- Validation of results and assessment of error based on bottom up mapping

**Key words:** Heat demand mapping; District heating; Energy Planning; GIS; Data-poor areas; Economic viability; Levelized cost of heat

**Word count:** 4751

## Abbreviations

DH	District heating
EU	European Union
GIS	Geographic information system
LCOH	Levelized cost of heat

## Nomenclature

Ag	Gross building footprint area [m <sup>2</sup> ]
Cg	Average cost of grid per observed square [EUR]
FH	Floor height [m]
H	Building height [m]

HD	Heat demand [MWh/year]
HD	Heat demand [MWh/year]
HDS	Specific heat demand per building type [MWh/m <sup>2</sup> /year]
HP-LCOH	Difference between the average heat price and the levelized cost of heat [EUR/MWh]
NG	net to gross area ratio per building type [-]

## 1. Introduction and motivation

The European Union (EU) has set a very ambitious goal of a total or at least near-total decarbonisation until 2050 [1]. The majority of the overall emissions are attributed to the fuel combustion and fugitive emissions from fuels (without transport) with 2420 million tonnes of CO<sub>2</sub> equivalent or 54% in 2017 [2]. Buildings are the largest single energy consumer, 40%, and greenhouse gas emitter, 36%, across the EU [3]. According to the 2018 Revision of World Urbanization Prospects, 55% of the total World population is currently living in urban areas and this will most likely increase to 68% by 2050 [4]. As more and more people move into densely populated urban areas the sustainable provision of energy for space heating, cooling and production of domestic hot water will become an ever-increasing issue. Heating represents the largest demand both in terms of total annual and peak loads in 25 of the 28 EU countries among heating cooling and electricity demand, although that could change in the future due to ever increasing electrification [5]. Energy efficiency increases can help alleviate the issue, but it becomes uneconomical after a point and energy production from renewable sources becomes cheaper than further efficiency increases.

The options for a sustainable provision of energy in densely populated urban areas are quite limited. The use of fossil fuels in individual boilers is not compatible with the vision of a decarbonised Europe by 2050, individual biomass fired boilers will pose significant logistical problems related to the supply of fuel and management of ash alongside potential environmental issues linked to particulate emissions, individual resistive electric heating will be sensitive to increases in electricity prices and can have negative effects on peak electricity demand while individual heat pumps can face issues due to space constraints and price.

District heating (DH) presents itself as the only viable option due to its ability to utilize waste and renewable energy and transport high energy densities across large distances. Waste heat is an especially important factor since it is clean, cheap and abundant as shown in [6] for an example of 33 countries and [7] for northern China. Additionally, DH can enable the utilization of sources such as solar [8] and geothermal [9] energy as well as heat pumps [10] where they are available or feasible and transport the energy to where it is needed. Since it is essentially a distribution technology, DH provides great flexibility with regards to the use of energy source and transformation technology and enables the utilization of several energy vectors for the production. It is also a crucial component of future smart energy systems and a key driver for a higher level of integration of renewable energy sources since it can provide flexibility to the electrical grid if power to heat technologies are used [11][12][13]. DH is not always economically feasible due to its high initial investment costs so a detailed investigation is needed to determine if and in which areas it should be utilized. Its feasibility depends on three key factors:

1. Heat demand density;
2. Necessary supply temperature;
3. Availability of waste and renewable energy sources.

Spatial analysis can help tackle these questions and provide, depending on the scope of the investigation, an initial or a detailed assessment of the areas suitable for the utilization of DH. Geographic information system (GIS) based tools such as qGIS [14] and ArcGIS [15] enable such operations.

The results of these assessments rely heavily on the availability and quality of data, both aggregated and spatially distributed. This data is often not available or at least not public which can result in the inability to perform spatial assessments of energy demand or at least to validate the outcomes. For

this reason, a three-step approach based mostly on publicly available data has been developed and implemented in this work, demonstrating a potential method for heat demand mapping and spatial assessment of the potential for the utilization of DH usable in data poor areas.

## **2. Heat mapping, district heating assessments and GIS utilization so far**

Unlike electricity which can be transported long distances with relatively low losses, heat needs to be produced and consumed in a restricted geographic area. Linear heat and pressure losses represent technical while the cost of the needed infrastructure impose economic limitations for viable distances of heat distribution. Due to these reasons, spatial assessments of heat demand and supply are a crucial tool for heat and DH planning.

Several examples of the utilization of GIS for heat mapping and DH assessments can be found in literature. [16] for example presents a methodology utilizing land use and population density data alongside national averages for heating demand to produce a heat map for the city of Sheffield. The authors expect an error in the range of 20-25% based on the limitation of the utilized data. Similarly to that approach, the authors of [17] used national statistics for the US, divided into 11 census regions in order to calculate per capita heat demand and develop a heat atlas for the continental US. The calculation has taken average heating degree days for every state as well as land use and population density data. An assessment of the potential for the utilisation of DH has been conducted based on a minimum demand threshold. Degree day and highly detailed population data has been used to develop a top down heat demand map of Switzerland in [18]. On the other hand, the authors of [19] utilized detailed georeferenced building stock data including information on the type, use and age of buildings as well as the accounts of Danish energy producers to develop a heat atlas as well as an assessment of the potential for the utilization of DH in comparison to heat pumps. Utilizing even more data including the Danish Buildings and Dwellings registry, energy audits and detailed energy databases in [20], the authors have created a heat atlas with a resolution of a single building. When compared to measured consumption data the mean error ranged from 1% for industry and private sector service buildings, 15% for multi-story dwellings to 50% for public research and education buildings. The potential for the utilization of DH has been assessed using cost-supply curves. The same database has been used in [21] for the development of a heat atlas in one Danish municipality and assess the costs of energy savings measures. The authors of [22] utilized the atlas developed in [20] in order to assess the viability of using low temperature heat sources, such as low temperature industry excess heat, supermarkets, waste water, drinking and usage water, ground water, rivers, lakes and sea water in DH via heat pumps. The authors of [23] used similarly detailed data, including measured energy consumption, census and detailed building data to develop an energy atlas for a limited area including 3600 buildings. The authors of [24] used a multilinear regression model to dis-aggregate the cities energy consumption data to a single dwelling level based on building and household data for the city of Rotterdam for gas and electricity. Detailed bottom up heat demand assessment has been conducted using a 3D model of the city and building stock data. The results were then aggregated to comply with data privacy regulations. Multilinear regression has also been utilized in [25] to develop a top down heat demand map for 14 of the EUs largest countries. The model has been calibrated using Denmark as a reference due to its detailed building registry. A fixed minimum supply density of 20 TJ/km<sup>2</sup> has been used in order to assess the viability of DH utilization. The viability of the utilization of sewage heat in DH in Tokyo has been assessed in [26]. A bottom up method utilizing building polygons, heights and type has been used to generate the heat map while spatial correlations of demand and potential supply have been utilized to assess the feasibility.

GIS is often used in the spatial assessment of potential energy supply as well. Examples include assessments of wind [27], geothermal [28], solar [29], solar PV [30], wind and solar [31], tidal [32] biomass [33] and biogas from manure [34] as well as manure and agricultural waste [35]. It has also been used in assessing of specific sectors such as European museums in [36], neighbourhood level algae production [37] or hydrogen in road transport in [38] for example.

As shown in this chapter, various methods for GIS based heat mapping and GIS mapping in general exist. One common thread between all of them is the need for quality data. This makes the development of high-resolution heat maps and assessments of DH potentials in data-poor areas difficult. The method presented in this paper addresses this issue with a reliance on public and, in the case of the calibration, municipally owned data. The assessment of viability of DH is usually handled through fixed minimum densities or through the development of cost curves. The former gives a quick and broad overview of the available potential but does not take the impact of potentially cheap sources of heat into account while the latter relies on the availability of detailed technical and economic data. The method proposed in this research allows for a flexible result which determines the viability of DH implementation through the minimum difference of price and levelized cost of heat (LCOH). This way, various heat sources can be considered through their LCOH, different economic conditions and business models' through the prices of heat and the method is not heavily reliant on detailed data which is often not available.

### **3. Methods and tools**

Due to the common lack of detailed data such as building censuses, existing energy demand and supply maps or public data used to create them, the proposed method utilized in this research relies on public databases as much as possible. Since this will inevitably require some assumptions, a three-step approach is proposed in order to calibrate and validate the results as well as assess the potential errors. These steps are:

1. Calculation of aggregate heat demand per defined region;
2. Bottom up demand mapping of one region;
3. Top down demand mapping of the entire observed area.

Once the maps are finalized, the potential for the utilization of district heating can be implemented.

#### **3.1. Calculation of aggregate heat demand**

The first step in the process is the definition of the highest level of aggregation for the calculation of the reference heat demand. In the case of this research, the level of individual municipalities has been selected. Following this selection, the heat demand of each municipality has been calculated based on the available data on the national and municipal level. The following data can be used for these calculations:

- Climate zone of the municipalities;
- Surface area of existing buildings per municipality or climate zone;
- Share of individual building types per municipality or climate zone;
- Specific heat demand per building category and climate zone;
- Population per climate zone;
- Population per municipality.

In this case, the total surface area of existing buildings in four categories, single family houses, multiapartment, private commercial and public buildings, have been collected as well as their shares based on construction period. Additionally, the specific heating demands per these categories were also gathered. Using these data, the total heat demand per climate zone has been calculated. Using the population data per climate zone, the specific per capita heat demand of each zone has been calculated and using that figure and the population of each individual municipality, the heat demand on a municipal level has been determined.

### 3.2. Bottom up mapping

Bottom up energy, in this case heat, demand mapping means that data is calculated with a very fine resolution and then aggregated to the final one. For the purpose of this research, the heat demand has initially been calculated on the level of each individual building and then aggregated to a resolution of 1 ha (square of 100 m by 100 m).

The building level calculation is based on the following parameters:

- Building location and footprint area;
- Building height;
- Land use;
- Specific heat demand per building use category;
- Average floor height per building category;
- Net to gross surface area ratio per building category.

The heat demand is calculated using Equation 1.

$$HD = A_g \cdot NG \cdot (H/FH) \cdot HD_s \quad \text{Equation 1}$$

HD – Heat demand [MWh/year]

$A_g$  – Gross building footprint area [m<sup>2</sup>]

NG – net to gross area ratio per building type [-]

H – Building height [m]

FH – Floor height [m]

$HD_s$  – Specific heat demand per building type [MWh/m<sup>2</sup>/year]

Once the heat demand is calculated it can be calibrated based on the municipal level data by modifying the floor height and net to gross surface area ratios per building category. Aside from the aggregate heat demand, the total heated surface area per building type can be compared and used for the calibration and validation of the results.

### 3.3. Top down mapping

Top down heat demand mapping is conducted by distributing the aggregate heat demand over a set area via georeferenced data. Depending on their availability, building census data, detailed population densities or building distribution databases can be used. Since detailed data on a national level are often not available, or not public, other sources can be utilised. This includes public pan-European or World-wide databases. Three main sources were utilized in this case:

- CORINE land cover maps [39];
- Population density map [40];
- Open street maps [41].

The CORINE land cover map provides information on the dominant type of land cover within the given grid. This includes both man-made structures and nature. Since only the first category is of interest, the CORINE map for the observed area was limited to layers representing buildings. Additionally, roads and areas covered by nature such as parks have been cut from the initial map to show a more realistic depiction of the actual situation. This map has then been intersected by a layer depicting the distribution of the municipalities and a 1ha grid. Finally, the data has been aggregated into the 1ha grid to obtain the areas per type of cover alongside the designation to which municipality each grid segment belongs. Weight factors are applied to each of the land cover types taken into account and the final aggregate cover area has been calculated.

A similar approach has been applied to the population density map. First, the specific population density per square meter has been calculated for each segment, the roads, bodies of water and natural coverage have been removed, and the resulting grid has been intersected with a vector layer representing the distribution of the municipalities and the grid of the selected resolution. Finally, the population density of each resulting square has been recalculated. The resulting map has then been correlated with the modified CORINE land cover map and a relation between the area and population

has been determined. This needs to be done since the CORINE land cover map does not recognize sparsely built up areas resulting in a significant error.

The combination of the modified CORINE land cover and population density maps has been used to distribute the calculated heat demand on a municipal level (described in chapter 3.1). This finally results in a heat demand map of the entire observed area with a resolution of 1 ha (square of 100 by 100 meters). These results can be compared with a bottom up map or similar reference data and calibrated accordingly. This process has been implemented in this case. The bottom up and top down data have been compared and the weight factors have been modified in order to minimize the difference.

### 3.4. Assessment of the potential for the utilization of district heating

In order to assess the potential for the utilization of district heating regardless of the heat supply technology, an assessment based on the difference of the average heat price and LCOH has been developed and implemented. The potential is calculated using Equation 2

$$(HP - LCOH) \cdot HD - C_g = 0 \quad \text{Equation 2}$$

(HP-LCOH) – Difference between the average heat price and the levelized cost of heat [EUR/MWh]

$C_g$  – Average cost of grid per observed square [EUR]

HD – Heat demand [MWh/year]

The HP-LCOH value is determined for each observed grid segment for which the result of the above presented equation equals 0. This provides the minimum difference between the average price at which the heat is sold at and the levelized cost of its production for which the implementation of district heating is economically justified. The grid cost,  $C_g$  represents the annual cost of the grid's installation (annual depreciation with a time frame of either its lifetime or the project funding duration) and its operation and maintenance. This way, it can be assumed that no grid exists. Since the specific grid cost depends greatly on the type of terrain, heat demand and available as well as necessary routes the grid can or must take, it is difficult or in some cases impossible to determine an accurate figure. For this purpose, several cost levels can be chosen, and results can be presented for each demonstrating the sensitivity of the assessments as well as presenting different results for different segments of the assessed areas. In cases where a specific cost can be determined with a high degree of accuracy, it can and should be used.

## 4. Implementation

The above-mentioned method has been applied on Croatia (aggregate heat demand calculation and top-down mapping) and the City of Zagreb (bottom up mapping). The City of Zagreb has been selected for the second step of the method for two reasons: it holds close to 20% of the total population of Croatia as well as roughly 23% of the total heat demand and the necessary data for the implementation of the step have been made available.

The aggregate heat demand of each municipality has been calculated based upon the Croatian census, official climate zone classification and the Long term strategy for the refurbishment of the building sector of Croatia [42]. Using these data sources and the method described in chapter 3.1. This resulted in the distribution of surface area per building type and climate zone as well as the aggregate heat demand per climate zone. Using this and the information on the population per climate zone and for each municipality, the aggregate heat demand for each one was determined.

The bottom up map has been created using the cities cadastre, land use maps and LIDAR recordings, all provided by the Office for Spatial Planning of the City of Zagreb, City Office for the Strategic Planning and Development of the City of Zagreb, City Office for Cadastre and Geodetic activities of the City of Zagreb as well as the City of Zagreb itself. The cadastre maps were used to define the location and footprint areas of each building, the land use map data was added to this dataset to determine



the use of each building and finally, the LIDAR was used to calculate each buildings height. Table 1 shows the assumptions used in the bottom up mapping of the City of Zagreb.

Table 1 Assumptions used in the bottom up mapping of the City of Zagreb

Building type	Floor height (FH) [m]	Net to gross ratio (NG)
Residential	3	0.75
Commercial	3.3	0.7
Public	2.8	0.7

Table 2 presents the specific heat demands used in the bottom up mapping of the City of Zagreb per building type. Unfortunately, no information on the age of the buildings or their condition is available so such data could not have been used in this case. Table 3 presents an additional modification of the specific heat demand based on the use type of the individual buildings. This modification is introduced to accommodate inclusion of buildings which are under construction, in occasional use or not in use, for example ruins.

Table 2 Specific heat demand per building category [43]

Building category	Specific heat demand [kWh/m <sup>2</sup> ]
Residential	179
Commercial	170
Public	170
Mixed	179
Agricultural	100
Special	170
Transport	170
Education	169
Sport and recreation (buildings only)	170
Market and trade	170
Hospitality and tourism	170
Religious	170
Healthcare	292

Table 3 Modification of specific heat demand

Special building category	Heat demand modification
Residential use	1
Commercial building	1
Auxiliary building	0.8
Buildings under construction	0
Sports and recreation	1
Public buildings	1
Ruin	0
Buildings for occasional use	0.7

The aggregated surface areas calculated on the level of each municipality and the values presented in Table 1 were used to calibrate the resulting map and with that the total aggregate heat demand of the City of Zagreb. Table 4 presents the results of this calibration. The reference building shares of the

residential, commercial and public categories for urban areas in Croatia as well as the calculated data obtained from the bottom up mapping of Zagreb can be seen.

Table 4 Reference aggregate and calculated bottom up data for the city of Zagreb

	Residential	Commercial	Public
Reference data [42]	67,14%	23,85%	9,01%
Bottom up mapping	67,06%	23,77%	9,17%

Data presented in Table 3 were used to calibrate the total aggregated heat demand alongside the data in Table 1. The difference in the bottom up and reference heat demands for the city of Zagreb is 0,6%

In order to move onto the top down calculation, the data sets used for the spatial distributions of the aggregate values need to be prepared. Figure 1 presents the spatial distribution of roads [41], bodies of water [39] and natural areas [39,41] used to modify the population distribution [40] and the CORINE land cover maps [39].

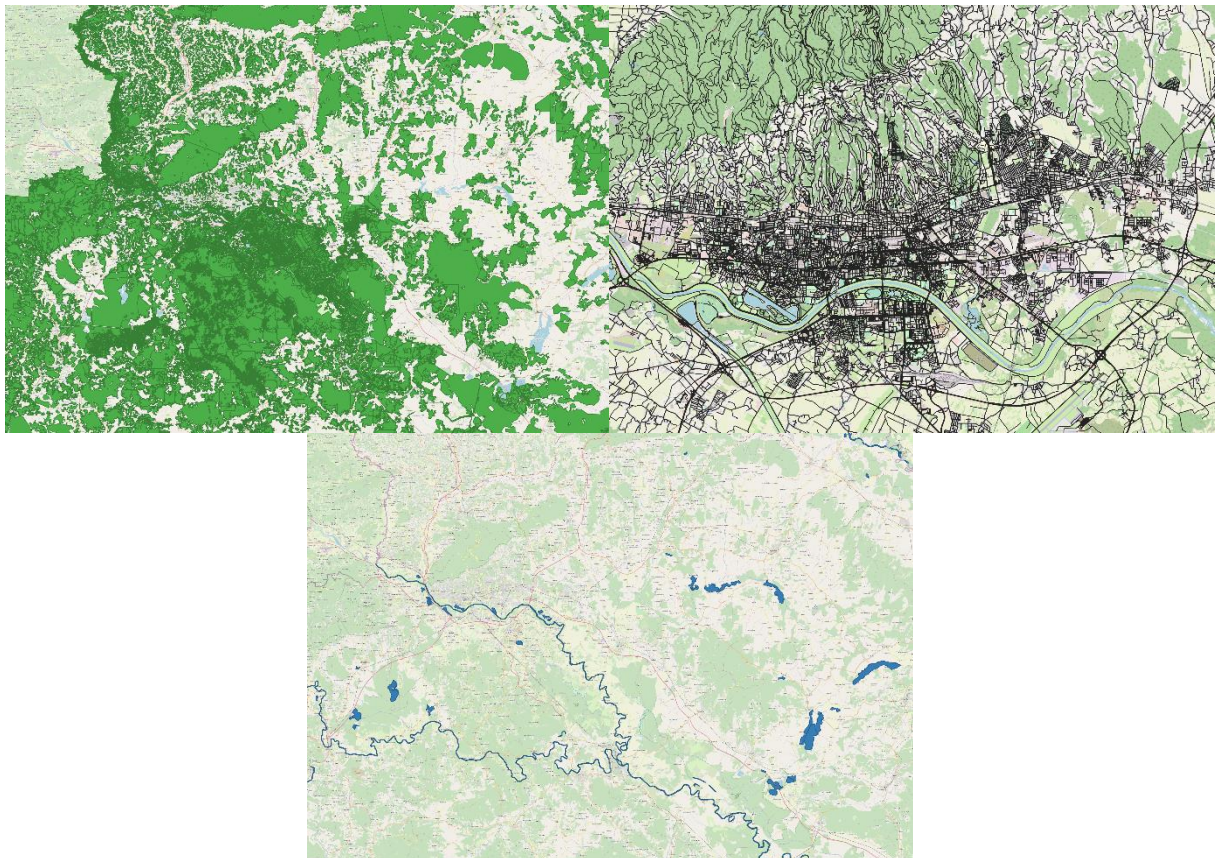


Figure 1 Spatial distribution of roads, bodies of water and natural areas

Figure 2 and Figure 3 present the result of the modification of the CORINE land cover and population density maps with the above presented data sets. As it can be seen, the resulting maps have a much more varied distribution and a more realistic representation of the real-world situation. These modified maps and the determined weight factors have been used to distribute the aggregate heat demand of each municipality on a 1 ha grid. The weight factors were obtained through an iterative process where the absolute sum of all differences between the top down and bottom up heat demand maps was minimised using Equation 1.

$$\sum_{n=1}^{n=X} |HD_{nTD} - HD_{nBU}| = \min$$

Equation 3

n – number of compared cells [-]

HD<sub>nTD</sub> – heat demand of cell n calculated using the top down method [MWh]

HD<sub>nBU</sub> – heat demand of cell n calculated using the bottom up method [MWh]

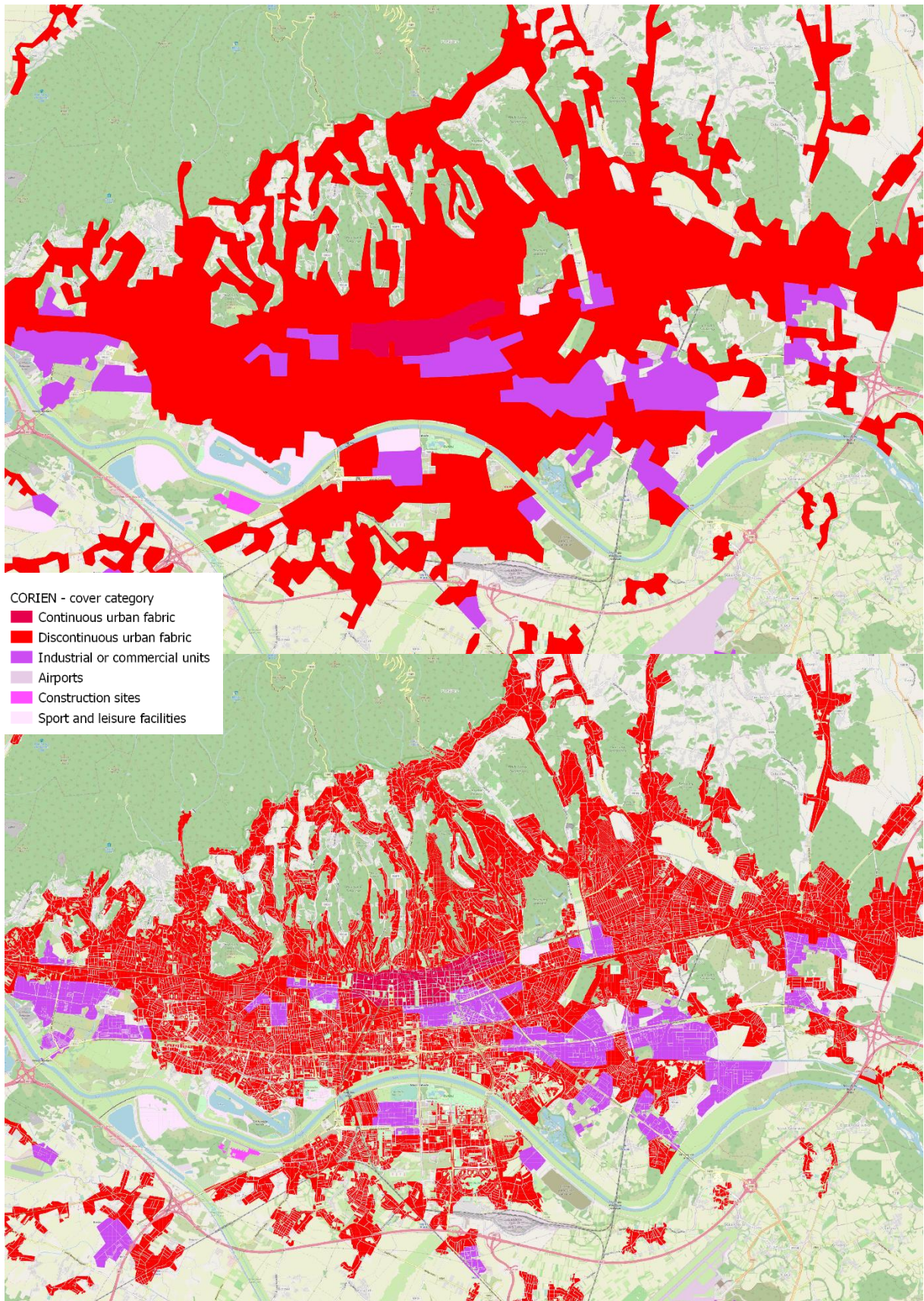


Figure 2 CORINE land cover map; original data (up) and modified data (down)

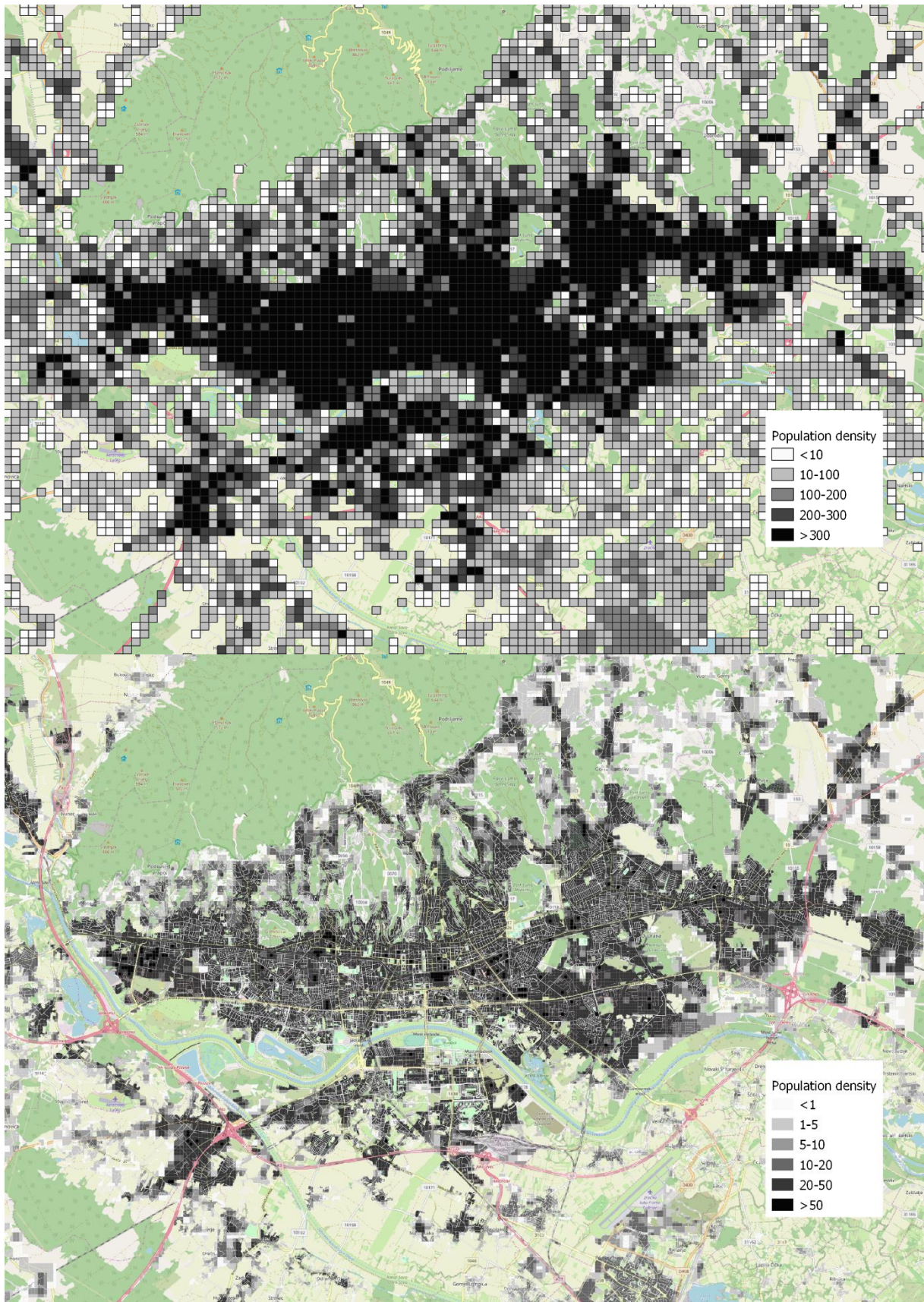


Figure 3 population density map; original data (up) and modified data (down)

The final weight factors can be seen in Table 5. The results of this process are presented in chapter 5.

Table 5 Final weight factors used for spatial distribution

CORINE code	Land cover type	Final weight factor
111	Continuous urban fabric	3,11
112	Discontinuous urban fabric	0,37
121	Industrial or commercial units	0,26
133	Construction sites	0,25
142	Sport and leisure areas	0,16

## 5. Results

Figure 4 presents an example of the results of the top down mapping of Croatia's heat demand with a resolution of 1 ha.

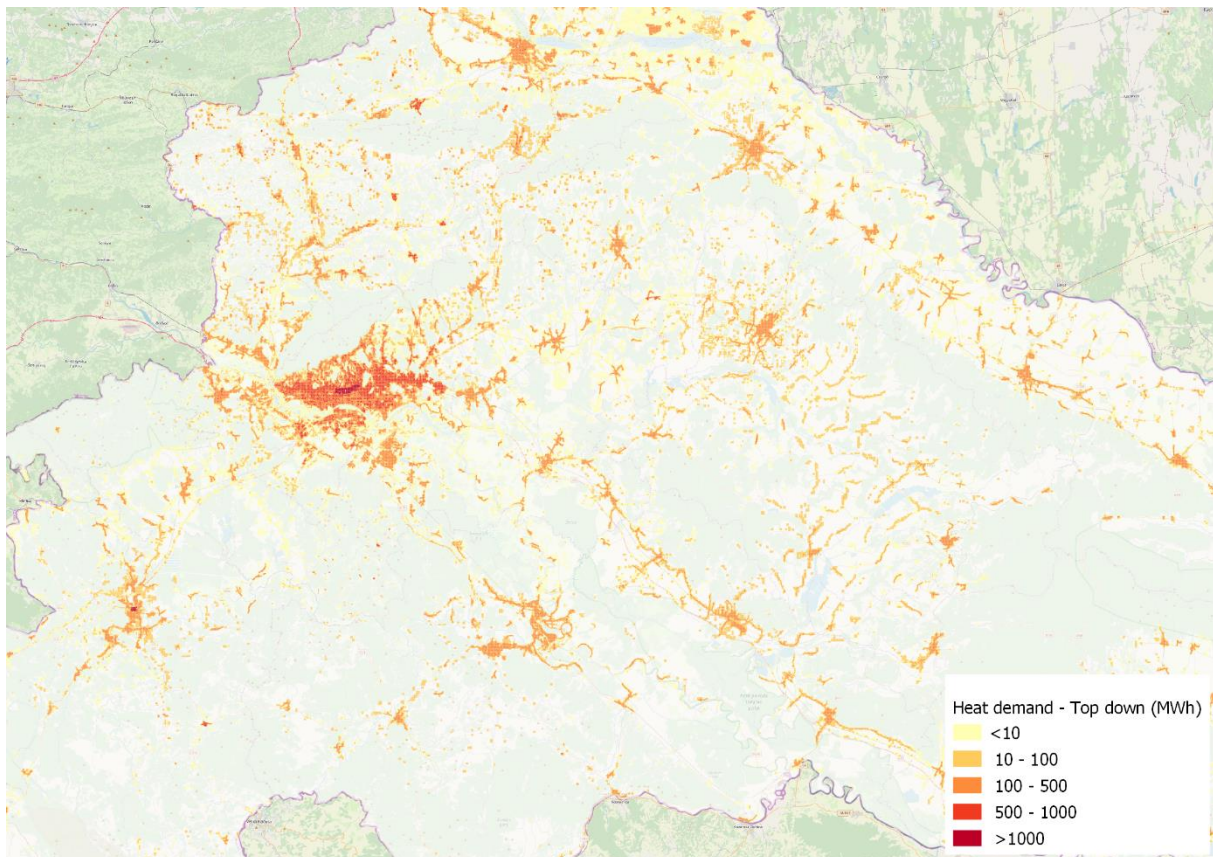


Figure 4 Top down heat demand

Figure 5 shows the comparison of the bottom up (above) and top down (below) heat demand mapping for the city of Zagreb. As the figure shows, the heat demand matches up visually for the two cases. It can be observed that the bottom up map has larger densities of demand distributed over a smaller area when compared with the top down map. This is expected since the bottom up mapping utilizes the actual distribution of built up areas based on individual buildings whereas the top down one relies on the distribution based on a fixed resolution. The removal of roads, bodies of water and natural areas does bring these distributions closer to one another, but some differences do persist. It is important to note that the total sum of both heat demands is the same.

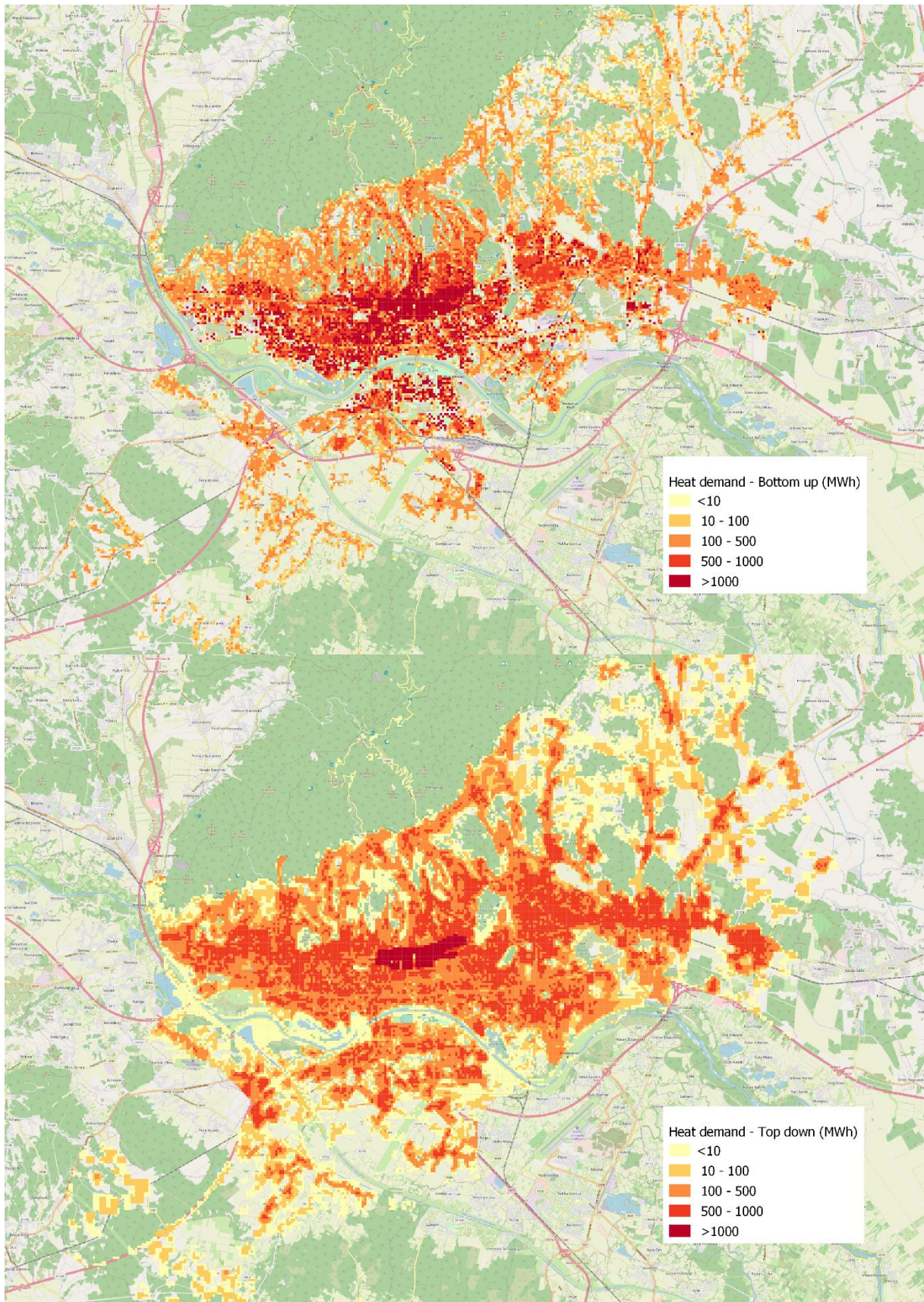


Figure 5 Bottom up (up) and top down (down) heat demand

The quantified differences between the two maps can be observed in Figure 6. It presents the heat demand (Y axis) of both maps for each 1 ha square based on their location (X axis). It is important to note here that the peak demand of both cases matches up both with regards to its location and magnitude. The peak demand of the bottom up map is 257.814 MWh, and 259.732 MWh for the top down one. This is a difference of 0,74%. The figure also represents the overall differences in peaks and spread of both maps where the bottom up one has higher peaks but a smaller spread then the top down one. This results in a relatively flatter curve for the top down map.

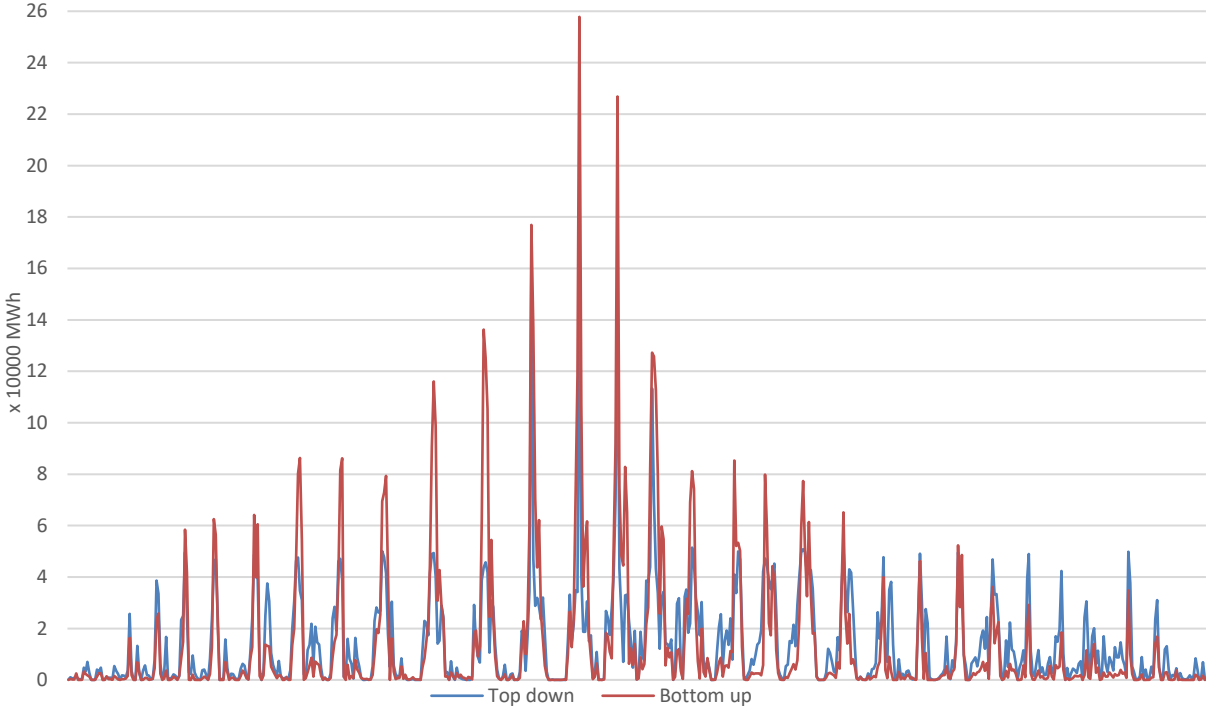


Figure 6 Distribution of top down and bottom up heat demand

Figure 7 shows the distribution curve for both maps in the format of a load duration curve. It can again be observed that the peak demand in both cases matches up and that the overall peaks of the bottom up map are higher on average.



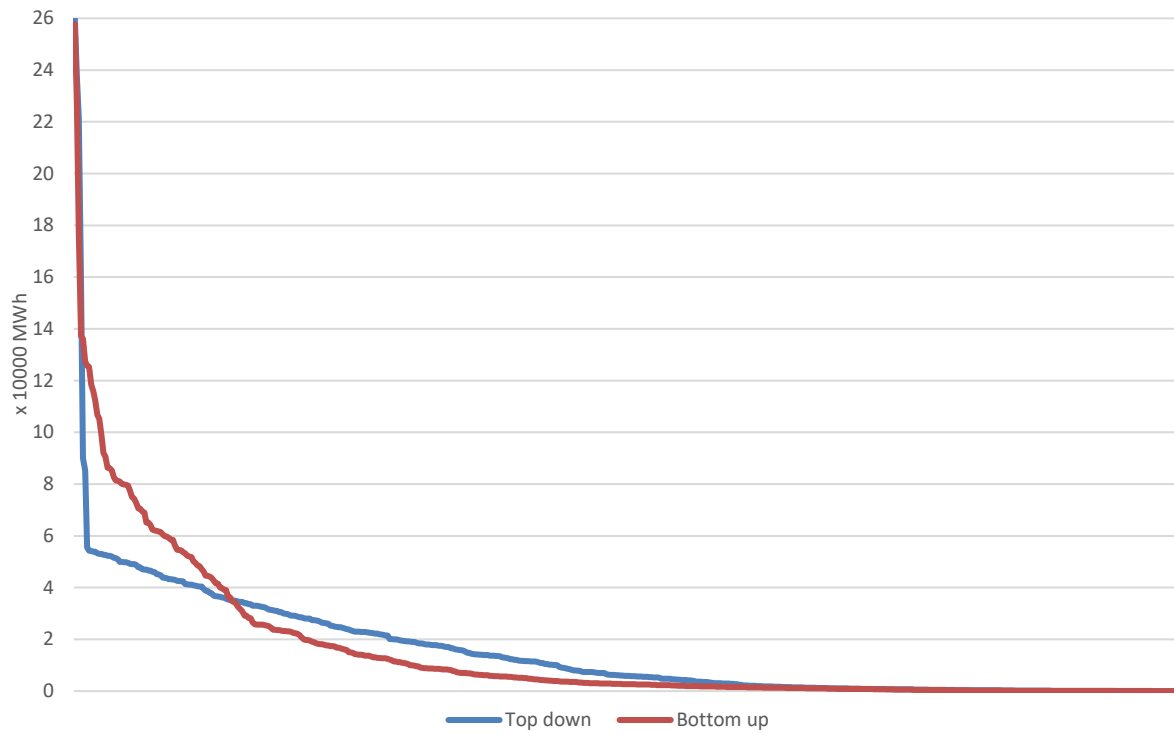


Figure 7 Distribution curve of top down and bottom up heat demand

Figure 8, Figure 9 and Figure 10 present the results of the DH potential analysis for three selected annual grid costs (5.000, 10.000 and 15.000 EUR/ha) at a resolution of 1 ha for the cities of Zagreb (left) and Rijeka (right). It can be observed that the assumed grid costs do have a significant impact on the end results, as was expected.

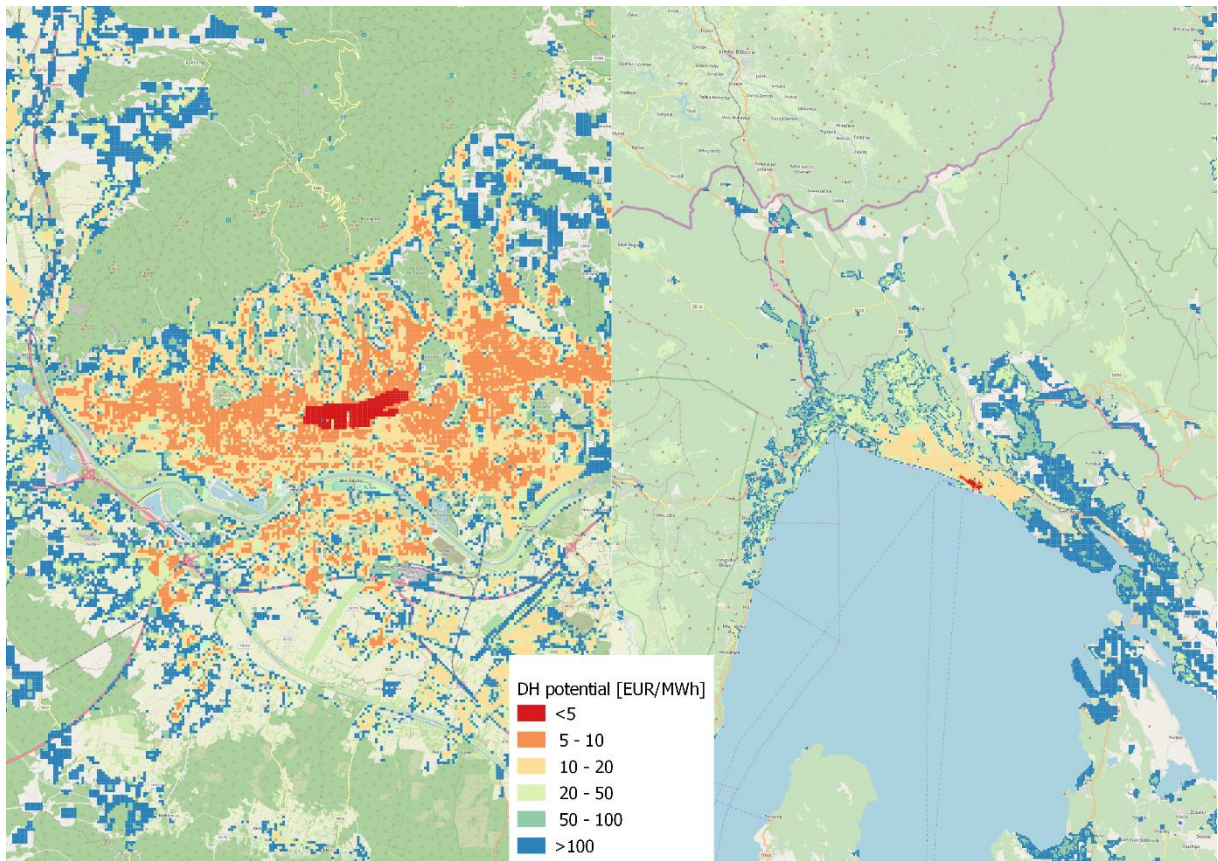


Figure 8 District heating potential with grid cost of 5.000 EUR/ha

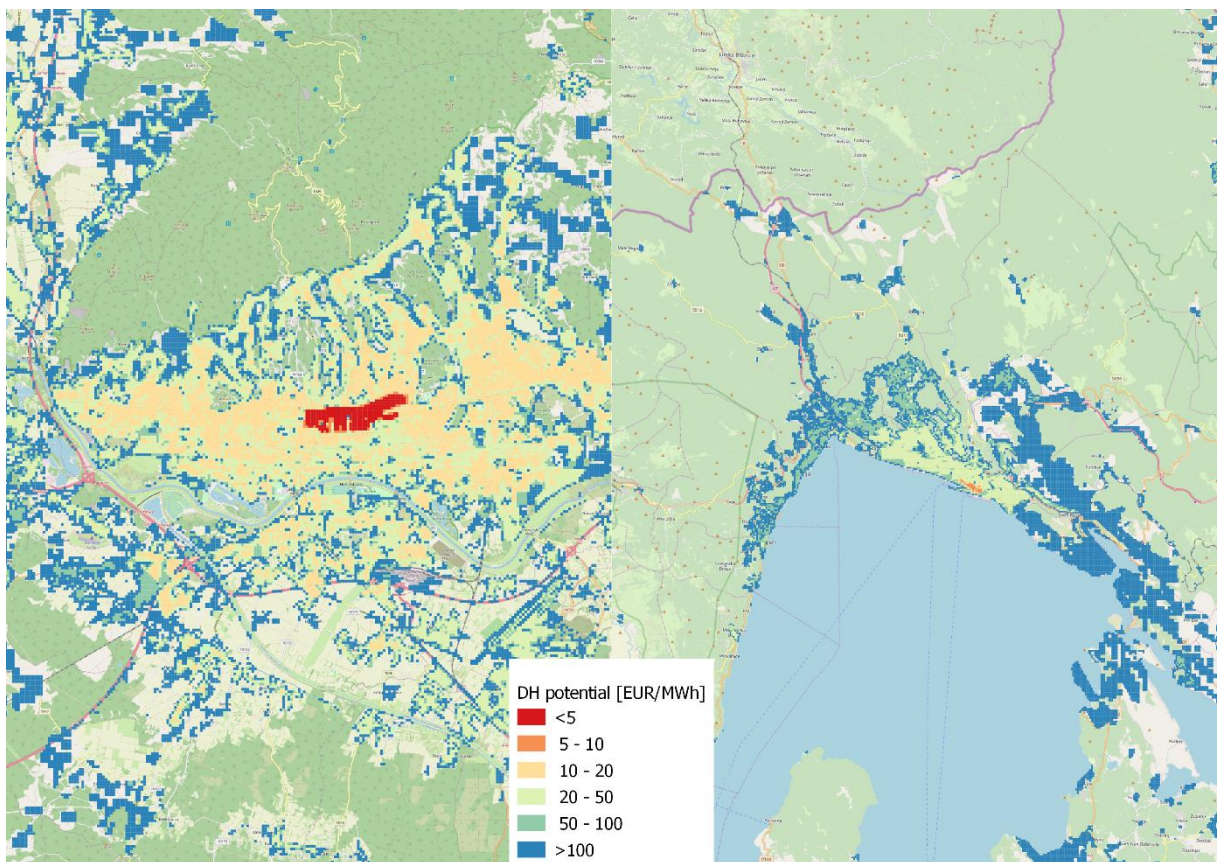


Figure 9 District heating potential with grid cost of 10.000 EUR/ha

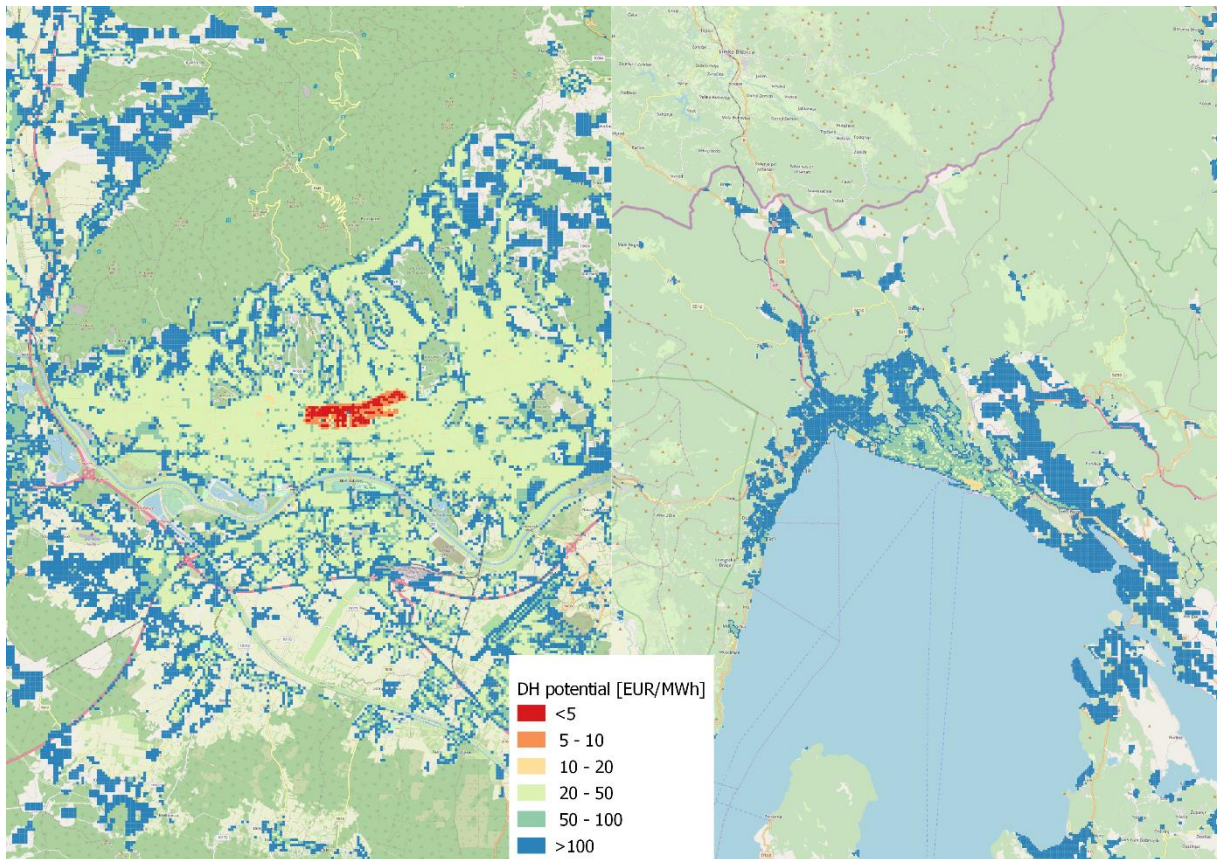


Figure 10 District heating potential with grid cost of 15.000 EUR/ha

Table 4 shows the comparison of the DH potential analysis for the bottom up and top down heat demand mapping for the City of Zagreb with the three different grid costs. The values in the table present which percentage of the heat demand falls below the HP-LCOH price level. This for example means that in the case of the 5.000 EUR/ha grid cost, 88% of the heat demand of the city can be economically covered through DH if the average price of heat is 20 EUR/MWh above the LCOH for the bottom up mapping method. The same result would be 90% in the case of top down mapping. In case of the 10.000 EUR/ha grid cost and the same heat price level, the results are 75% for the bottom up and 55% for the top down mapping method. The table also shows a consistent underestimation of the potential for the top down mapping when compared with bottom up at lower prices. This is to be expected because of the lower peaks of heat demand in the top down maps when compared to bottom up ones, as seen in Figure 6 and Figure 7. These differences are smaller for lower grid costs and larger for the higher ones. It can therefore be concluded that the results of the top down mapping can be considered as conservative.

Table 6 District heating potential for the City of Zagreb at a resolution of 100X100m

Price EUR	5 kEUR		10 kEUR		15 kEUR	
	Bottom up	Top Down	Bottom up	Top Down	Bottom up	Top Down
<5	52%	11%	30%	10%	16%	6%
<10	74%	55%	52%	11%	40%	11%
<15	84%	84%	66%	13%	52%	11%
<20	88%	90%	74%	55%	62%	12%
<25	91%	93%	80%	77%	69%	24%
<30	93%	95%	84%	84%	74%	55%

<35	94%	95%	86%	88%	78%	72%
<40	95%	96%	88%	90%	81%	80%
<45	96%	96%	90%	92%	84%	84%
<50	97%	96%	91%	93%	86%	86%
<55	97%	97%	92%	94%	87%	89%
<60	97%	97%	93%	95%	88%	90%
<65	98%	98%	94%	95%	90%	91%
<70	98%	98%	94%	95%	90%	92%
<75	98%	98%	95%	95%	91%	93%
<80	98%	98%	95%	96%	92%	94%
<85	98%	98%	96%	96%	93%	95%
<90	99%	98%	96%	96%	93%	95%
<95	99%	98%	96%	96%	94%	95%
<100	99%	98%	97%	96%	94%	95%

Table 7 shows the same results as Table 6 but for a resolution of 100 ha.

Table 7 District heating potential for the City of Zagreb at a resolution of 1.000X1.000m

Price EUR	400 kEUR		800 kEUR		1.200 kEUR	
	Bottom up	Top Down	Bottom up	Top Down	Bottom up	Top Down
<5	34%	13%	8%	9%	3%	3%
<10	67%	45%	34%	13%	16%	11%
<15	74%	68%	58%	16%	34%	13%
<20	81%	78%	67%	45%	51%	13%
<25	86%	85%	72%	59%	62%	28%
<30	88%	89%	74%	68%	67%	45%
<35	90%	91%	79%	74%	71%	54%
<40	90%	93%	81%	78%	72%	62%
<45	91%	93%	83%	83%	74%	68%
<50	93%	93%	86%	85%	77%	72%
<55	93%	94%	86%	86%	80%	77%
<60	93%	95%	88%	89%	81%	78%
<65	94%	95%	89%	89%	83%	81%
<70	94%	96%	90%	91%	85%	84%
<75	95%	96%	90%	92%	86%	85%
<80	95%	97%	90%	93%	86%	86%
<85	95%	97%	91%	93%	87%	87%
<90	96%	97%	91%	93%	88%	89%
<95	96%	97%	92%	93%	89%	89%
<100	96%	98%	93%	93%	89%	90%

Table 8 presents the results of the DH potential assessment based on the top down heat demand map of Croatia on a 1 ha raster. It can for example be observed that at a PH-LCOH (Price EUR in the table) level of 30 EUR/MWh, 61% of the total heat could be economically supplied trough DH if the network

cost is 5.000 EUR/ha annually on average. This level drops to 31% and 16% for grid costs of 10.000 and 15.000 EUR/ha.

Table 8 District heating potential for Croatia at a resolution of 100X100m

Price EUR	5 kEUR	10 kEUR	15 kEUR
<5	3%	2%	1%
<10	16%	3%	3%
<15	31%	4%	3%
<20	44%	16%	4%
<25	54%	25%	7%
<30	61%	31%	16%
<35	67%	38%	22%
<40	71%	44%	27%
<45	75%	49%	31%
<50	77%	54%	36%
<55	79%	58%	40%
<60	81%	61%	44%
<65	82%	64%	48%
<70	84%	67%	51%
<75	84%	69%	54%
<80	85%	71%	57%
<85	86%	73%	59%
<90	87%	75%	61%
<95	87%	76%	63%
<100	88%	77%	65%

## 6. Discussion

The results presented in Table 8 demonstrate a significant potential for the economic utilization of DH in Croatia. Depending on the assumed grid cost, this ranges from 77% to 36% at a heat price of 50 EUR/MWh above the LCOH. The range of results also points at a very strong impact of the network costs on the overall economic feasibility of DH systems. The results of the study demonstrate a high potential for the economically feasible utilization of DH in the case of both Croatia and the City of Zagreb. The methodology presented in this research allows for a lot of flexibility both from the perspective of grid costs and supply options. By creating maps with different grid costs, it is possible to identify priority areas and “hotspots” of DH potential with a variety of criteria. Densely built up urban areas can, for example, be assessed utilizing a higher grid cost assumption than a more sparsely built up one due to the higher costs of construction (need to dig below built up areas) and a need for more pipes per hectare (due to a larger number of users per ha). On the other hand, by assuming a heat price and identifying potential technologies for its supply in a given area, a price level can be selected as a reference point. For example, if a price of heat of 70 EUR per MWh is assumed and a source with a LCOH of 20 EUR/MWh is available, a price level of 50 EUR can be taken as a reference for the assessment of the potential of DH supply. Taking both variations into account allows for the flexibility needed for such assessments to be made in areas lacking high quantities of quality public data.

The validation of the heat demand mapping presented in Figure 5, Figure 6 and Figure 7 as well as Table 6 and Table 7 point towards the same conclusion. The top down mapping demonstrated in this research will result in lower average peaks but a wider average spread of the heat demand when

compared with bottom up mapping. This is especially visible in Figure 6 where a comparison of both mapping methods is shown. The figure presents both heat demands for each 1 ha area. This difference is to be expected since bottom up mapping uses less uniform data of a higher resolution, individual buildings compared to a limited number of cover types or population levels. The impact of these differences on the result of the assessment of the viability of DH depends greatly on the assumed costs of the DH grid. It can be seen that the potential is consistently lower in the case where the top down map is utilized. The impacts are strongest at low price levels and at high assumed grid costs. This strongly points to the conclusion that the results of the top down mapping can be taken as conservative.

The demonstrated mapping and assessment method relies mostly on public data in the form of national aggregated energy statistics and public georeferenced databases, while limiting the use of more detailed data which is often only available for a very limited area for the validation and calibration steps. This approach allows data poor areas to develop high resolution and high quality heat demand maps and DH assessments with the limited data available to them.

## **7. Conclusion and future work**

The research in this paper presents a method for heat mapping and the spatial assessment of the viability of DH in data-poor areas. It relies mostly on publicly available and, for the purpose of calibration and validation, municipally owned data. The method consists of the following three steps:

1. Calculation of aggregate heat demand per defined region;
2. Bottom up demand mapping of one region;
3. Top down demand mapping of the entire observed area.

The spatial assessment of the viability of district heating utilizes the difference between the average heat price and the levelized cost of heat instead of a fixed minimal density or cost curves to both provide a flexible set of results and be usable in cases where detailed economic and technical data is not available. This results in a flexible method which allows for a varied assessment of different areas considering a wide variety of potential heat sources and technologies.

The heat demand mapping and assessment of district heating viability has been implemented on the case of Croatia (steps 1 and 3) with the City of Zagreb used for the validation and calibration of the top down mapping step (step 2). The results of the validation show an expected deviation between the results of the bottom up and top down mapping due to the difference in peaks in heat demand which are the result of the higher resolution of the data used in the bottom up mapping. These deviations impact the assessments of the viability of district heating as well, with a stronger impact in cases where a higher grid costs is assumed.

The overall method provides a flexible tool for the assessment of the viability of district heating systems in data poor areas, regardless of the utilized heat sources. The final results of this method do demonstrate a consistent underestimate of the DH potential due to the uniformity of the publicly available spatial data if compared to a detailed bottom up assessment, however these discrepancies are mostly present in the cases where the assumed heat price is only marginally higher than the LCOH. The future work related to this research will focus on the spatial assessment of cooling demand and district cooling potential.

## **Acknowledgement**

This research did not receive any specific grant from funding agencies in the public, commercial, or not-for-profit sectors.

## **List of references**

- [1] EUROPEAN COMMISSION. A European strategic long-term vision for a prosperous, modern,

- competitive and climate neutral economy 2018. <https://eur-lex.europa.eu/legal-content/EN/TXT/HTML/?uri=CELEX:52018DC0773&from=EN> (accessed October 7, 2019).
- [2] Eurostat. Greenhouse gas emission statistics - emission inventories. 2019.
- [3] European Commission. The Energy Performance of Buildings Directive Factsheet. 2019.
- [4] United Nations. 2018 Revision of World Urbanization Prospects. 2018.
- [5] Connolly D. Heat Roadmap Europe: Quantitative comparison between the electricity, heating, and cooling sectors for different European countries. *Energy* 2017;139:580–93. <https://doi.org/10.1016/j.energy.2017.07.037>.
- [6] Miró L, Brückner S, Cabeza LF. Mapping and discussing Industrial Waste Heat (IWH) potentials for different countries. *Renew Sustain Energy Rev* 2015;51:847–55. <https://doi.org/10.1016/j.rser.2015.06.035>.
- [7] Luo A, Fang H, Xia J, Lin B, Jiang Y. Mapping potentials of low-grade industrial waste heat in Northern China. *Resour Conserv Recycl* 2017;125:335–48. <https://doi.org/10.1016/j.resconrec.2017.06.018>.
- [8] Huang J, Fan J, Furbo S. Feasibility study on solar district heating in China. *Renew Sustain Energy Rev* 2019;108:53–64. <https://doi.org/10.1016/j.rser.2019.03.014>.
- [9] Huculak M, Jarczewski W, Dej M. Economic aspects of the use of deep geothermal heat in district heating in Poland. *Renew Sustain Energy Rev* 2015;49:29–40. <https://doi.org/10.1016/j.rser.2015.04.057>.
- [10] Averfalk H, Ingvarsson P, Persson U, Gong M, Werner S. Large heat pumps in Swedish district heating systems. *Renew Sustain Energy Rev* 2017;79:1275–84. <https://doi.org/10.1016/J.RSER.2017.05.135>.
- [11] Lund H, Werner S, Wiltshire R, Svendsen S, Thorsen JE, Hvelplund F, et al. 4th Generation District Heating (4GDH). Integrating smart thermal grids into future sustainable energy systems. *Energy* 2014;68:1–11. <https://doi.org/10.1016/j.energy.2014.02.089>.
- [12] Lund H, Duic N, Østergaard PA, Mathiesen BV. Smart Energy and District Heating: Special Issue dedicated to the 2016 Conference on Smart Energy Systems and 4 th Generation District heating. *Energy*, vol. 160, Elsevier Ltd; 2018, p. 1220–3. <https://doi.org/10.1016/j.energy.2018.07.012>.
- [13] Lund H, Duic N, Østergaard PA, Mathiesen BV. Future district heating systems and technologies: On the role of smart energy systems and 4th generation district heating. *Energy* 2018;165:614–9. <https://doi.org/10.1016/j.energy.2018.09.115>.
- [14] QGIS project! n.d. <http://www.qgis.org/en/site/> (accessed May 18, 2017).
- [15] ArcGIS n.d. <https://www.arcgis.com/index.html> (accessed October 7, 2019).
- [16] Finney KN, Sharifi VN, Swithenbank J, Nolan A, White S, Ogden S. Developments to an existing city-wide district energy network - Part I: Identification of potential expansions using heat mapping. *Energy Convers Manag* 2012;62:165–75. <https://doi.org/10.1016/j.enconman.2012.03.006>.
- [17] Gils HC, Cofala J, Wagner F, Schöpp W. GIS-based assessment of the district heating potential in the USA. *Energy* 2013;58:318–29. <https://doi.org/10.1016/j.energy.2013.06.028>.
- [18] Berger M, Worlitschek J. A novel approach for estimating residential space heating demand. *Energy* 2018;159:294–301. <https://doi.org/10.1016/j.energy.2018.06.138>.
- [19] Nielsen S, Möller B. GIS based analysis of future district heating potential in Denmark. *Energy* 2013;57:458–68. <https://doi.org/10.1016/j.energy.2013.05.041>.
- [20] Möller B, Nielsen S. High resolution heat atlases for demand and supply mapping. *Int J Sustain Energy Plan Manag* 2014;1:41–58. <https://doi.org/10.5278/ijsepm.2014.1.4>.
- [21] Petrović S, Karlsson K. Ringkøbing-Skjern energy atlas for analysis of heat saving potentials in building stock. *Energy* 2016;110:166–77. <https://doi.org/10.1016/j.energy.2016.04.046>.
- [22] Lund R, Persson U. Mapping of potential heat sources for heat pumps for district heating in Denmark. *Energy* 2016;110:129–38. <https://doi.org/10.1016/J.ENERGY.2015.12.127>.
- [23] Torabi Moghadam S, Toniolo J, Mutani G, Lombardi P. A GIS-statistical approach for assessing built environment energy use at urban scale. *Sustain Cities Soc* 2018;37:70–84.

- <https://doi.org/10.1016/j.scs.2017.10.002>.
- [24] Nouvel R, Mastrucci A, Leopold U, Baume O, Coors V, Eicker U. Combining GIS-based statistical and engineering urban heat consumption models: Towards a new framework for multi-scale policy support. *Energy Build* 2015;107:204–12. <https://doi.org/10.1016/j.enbuild.2015.08.021>.
- [25] Möller B, Wiechers E, Persson U, Grundahl L, Connolly D. Heat Roadmap Europe: Identifying local heat demand and supply areas with a European thermal atlas. *Energy* 2018;158:281–92. <https://doi.org/10.1016/j.energy.2018.06.025>.
- [26] Ichinose T, Kawahara H. Regional feasibility study on district sewage heat supply in Tokyo with geographic information system. *Sustain Cities Soc* 2017;32:235–46. <https://doi.org/10.1016/j.scs.2017.04.002>.
- [27] Jangid J, Bera AK, Joseph M, Singh V, Singh TP, Pradhan BK, et al. Potential zones identification for harvesting wind energy resources in desert region of India – A multi criteria evaluation approach using remote sensing and GIS. *Renew Sustain Energy Rev* 2016;65:1–10. <https://doi.org/10.1016/j.rser.2016.06.078>.
- [28] Viesi D, Galgaro A, Visintainer P, Crema L. GIS-supported evaluation and mapping of the geo-exchange potential for vertical closed-loop systems in an Alpine valley, the case study of Adige Valley (Italy). *Geothermics* 2018;71:70–87. <https://doi.org/10.1016/j.geothermics.2017.08.008>.
- [29] Groppi D, de Santoli L, Cumo F, Astiaso Garcia D. A GIS-based model to assess buildings energy consumption and usable solar energy potential in urban areas. *Sustain Cities Soc* 2018;40:546–58. <https://doi.org/10.1016/j.scs.2018.05.005>.
- [30] Pili S, Desogus G, Melis D. A GIS tool for the calculation of solar irradiation on buildings at the urban scale, based on Italian standards. *Energy Build* 2018;158:629–46. <https://doi.org/10.1016/j.enbuild.2017.10.027>.
- [31] Anwarzai MA, Nagasaka K. Utility-scale implementable potential of wind and solar energies for Afghanistan using GIS multi-criteria decision analysis. *Renew Sustain Energy Rev* 2017;71:150–60. <https://doi.org/10.1016/j.rser.2016.12.048>.
- [32] Defne Z, Haas KA, Fritz HM. GIS based multi-criteria assessment of tidal stream power potential: A case study for Georgia, USA. *Renew Sustain Energy Rev* 2011;15:2310–21. <https://doi.org/10.1016/j.rser.2011.02.005>.
- [33] Zyadin A, Natarajan K, Latva-Käyrä P, Igliński B, Iglińska A, Trishkin M, et al. Estimation of surplus biomass potential in southern and central Poland using GIS applications. *Renew Sustain Energy Rev* 2018;89:204–15. <https://doi.org/10.1016/j.rser.2018.03.022>.
- [34] Venier F, Yabar H. Renewable energy recovery potential towards sustainable cattle manure management in Buenos Aires Province: Site selection based on GIS spatial analysis and statistics. *J Clean Prod* 2017;162:1317–33. <https://doi.org/10.1016/j.jclepro.2017.06.098>.
- [35] Zareei S. Evaluation of biogas potential from livestock manures and rural wastes using GIS in Iran. *Renew Energy* 2018;118:351–6. <https://doi.org/10.1016/j.renene.2017.11.026>.
- [36] van Schijndel AWMJ, Schellen HLH. Mapping future energy demands for European museums. *J Cult Herit* 2018;31:189–201. <https://doi.org/10.1016/j.culher.2017.11.013>.
- [37] Dutt F, Quan SJ, Woodworth E, Castro-Lacouture D, Stuart BJ, Yang PPJ. Modeling algae powered neighborhood through GIS and BIM integration. *Energy Procedia*, vol. 105, Elsevier Ltd; 2017, p. 3830–6. <https://doi.org/10.1016/j.egypro.2017.03.896>.
- [38] Rahmouni S, Settou N, Negrou B, Gouareh A. GIS-based method for future prospect of hydrogen demand in the Algerian road transport sector. *Int J Hydrogen Energy* 2016;41:2128–43. <https://doi.org/10.1016/j.ijhydene.2015.11.156>.
- [39] Copernicus. CORINE Land Cover — Copernicus Land Monitoring Service n.d. <https://land.copernicus.eu/pan-european/corine-land-cover> (accessed May 6, 2018).
- [40] European Commission J. Global Human Settlement n.d. <https://ghsl.jrc.ec.europa.eu/index.php> (accessed October 7, 2019).
- [41] OpenStreetMap n.d. <https://www.openstreetmap.org/#map=7/50.510/4.475> (accessed October 7, 2019).



- [42] Ministarstvo graditeljstva i prostornog uređenja. Dugoročna strategija za poticanje ulaganja u obnovu nacionalnog fonda zgrada Republike Hrvatske. Zagreb: 2014.
- [43] Sustainable Energy Action Plan - Zagreb. Zagreb: 2010.

# PAPER 5

# **Sustainable cooling supply of cities and urban areas – Spatial assessment of cooling demand and district cooling potential using public data**

## **Abstract**

Europe's building sector represents its largest single energy consumers and greenhouse gas emitters. Although space heating and the preparation of domestic hot water are responsible for the largest share of their energy demand, cooling is becoming an important factor with the rise of the global temperatures and the increased living standards across the continent. The decarbonisation of the cooling sector is a challenge especially relevant in densely populated urban areas and as with heating, district cooling is proving to be an effective solution for the supply of the needed energy densities in these conditions. However, unlike district heating, the assessment of the potential for the utilization of district cooling is not well addressed and researched. The research in this paper proposes a flexible method for the assessment of the spatial distribution of cooling demand and the assessment of the viability for the utilization of district cooling using mostly public data combining a bottom-up and top-down mapping approach. The method has been implemented on the case study of Croatia (top-down) and the City of Zagreb (bottom-up) and it demonstrated a high potential for the utilization of district cooling in both cases.

**Keywords:** Cooling demand mapping; District cooling; Energy Planning; GIS; Levelized cost of cooling; Urban cooling

**Funding:** This research did not receive any specific grant from funding agencies in the public, commercial, or not-for-profit sectors.

## **1. Introduction**

The European Union (EU) is setting ever more ambitious energy and climate goals with the ultimate target of a total or at least near total decarbonisation by 2050 (EUROPEAN COMMISSION, 2018). With 55% of the World's population currently living in urban areas and a trend of this figure increasing to 68% by 2050 (United Nations, 2018), it is evident that the sustainable supply of energy in cities and other densely populated areas is a priority. This point is additionally supported by the fact that buildings are the largest single energy consumers and greenhouse gas emitter responsible for 40% of the primary energy demand and 36% of all emissions across the EU (European Commission, 2019). Power and heat supply are mostly at the centre of this discussion, however with the impact of global warming and climate change as well as the increased purchasing power and higher living standards across Europe the supply of energy for cooling is becoming more important. This is highlighted in the European Environment Agency research (European Environment Agency, n.d.) which shows that the average population-weighted cooling degree days are steadily increasing. The linear trend from 1981 until 2017 shows an increase from 73,7 to 107,2 cooling degree days. The linear trend of the average population-weighted heating degree days has declined in the same period from a value of 2.314,4 to 2.082 heating degree days.

The importance of district heating as an option for the sustainable supply of heat and the utilization of various renewable energy sources such as geothermal (Huculak, Jarczewski, & Dej, 2015) and solar (Huang, Fan, & Furbo, 2019) as well as waste heat (Oró, Taddeo, & Salom, 2019) is very well researched as is its potential to act as mechanism to link the power and heating sectors (Lund, Duic, Østergaard, & Mathiesen, 2018). This is also true for the use of Geographic information system (GIS) based tools such as qGIS ("QGIS project!," n.d.) and ArcGIS ("ArcGIS," n.d.) in the assessments of their potential and viability (Novosel, Pukšec,

Duić, & Domac, 2020), (Meha, Thakur, Novosel, Pukšec, & Duić, 2021). Outside of the heating sector, GIS tools are also often used in a variety of other energy related fields such as the assessment of wind (Jangid et al., 2016), geothermal (Viesi, Galgaro, Visintainer, & Crema, 2018), solar, (Groppi, de Santoli, Cumo, & Astiaso Garcia, 2018) and biomass (Zyadin et al., 2018) for example. It has also been used in the assessment of specific sectors relevant to cities and urban areas such as the prediction of urban heat islands (Equere, Mirzaei, Riffat, & Wang, 2021), energy demand of cultural buildings (van Schijndel & Schellen, 2018), algae production (Dutt et al., 2017) and the viability of hydrogen for road transport (Rahmouni, Settou, Negrou, & Gouareh, 2016). On the other hand, the spatial assessment of cooling demand and the viability of district cooling is still under-explored. Some research into the topic does exist, for example the Pan-European Thermal Atlas developed under the Heatroadmap Europe project, does include cooling demand assessments (Möller et al., 2019), (Connolly, 2017), however the focus is firmly placed on the aspect of heat supply and demand. The authors of (Pampuri, Cereghetti, Strepparava, & Caputo, 2016) have proposed a method to use electricity consumption data to assess actual cooling needs with high accuracy while the authors of (Yi & Peng, 2017) have correlated cooling demand with local climate data and real estate prices for the case of Seoul. Both methods require detailed data which is often not available, such as remote metering data in the case of the former and microclimate data in the case of the later work. The lack of research into the use of district cooling when compared to heating is likely linked to its lower rate of utilisation.

Most of the benefits and the limitations of district heating are valid for district cooling as well. It enables the utilization of otherwise unusable cooling sources such as free and waste cooling (Fahlén, Trygg, & Ahlgren, 2012), (Hsu, Lin, Liang, Lai, & Chen, 2019), as well as the diversification of supply options (Thakar, Patel, & Patel, 2021). As with heating, district

cooling is most suited for high-density urban areas (Shi, Hsieh, Fonseca, & Schlueter, 2020), (Shi, Fonseca, & Schlueter, 2021) where it can lead to significant efficiency gains (Alajmi & Zedan, 2020). District cooling provides the potential to supply renewable cooling at higher energy densities, lower costs and with lower land use, compared to individual systems thus making them a vital component in the decarbonisation of the building sector and the overall sustainability of the energy supply in densely populated urban areas. The high investment costs in such systems as well as the reliance of its economic feasibility on the spatial conditions and the location of the potential supply and demand make GIS based tools ideal for the assessment of its potential. The quality of these assessments is reliant on the quality and availability of data which is often not accessible.

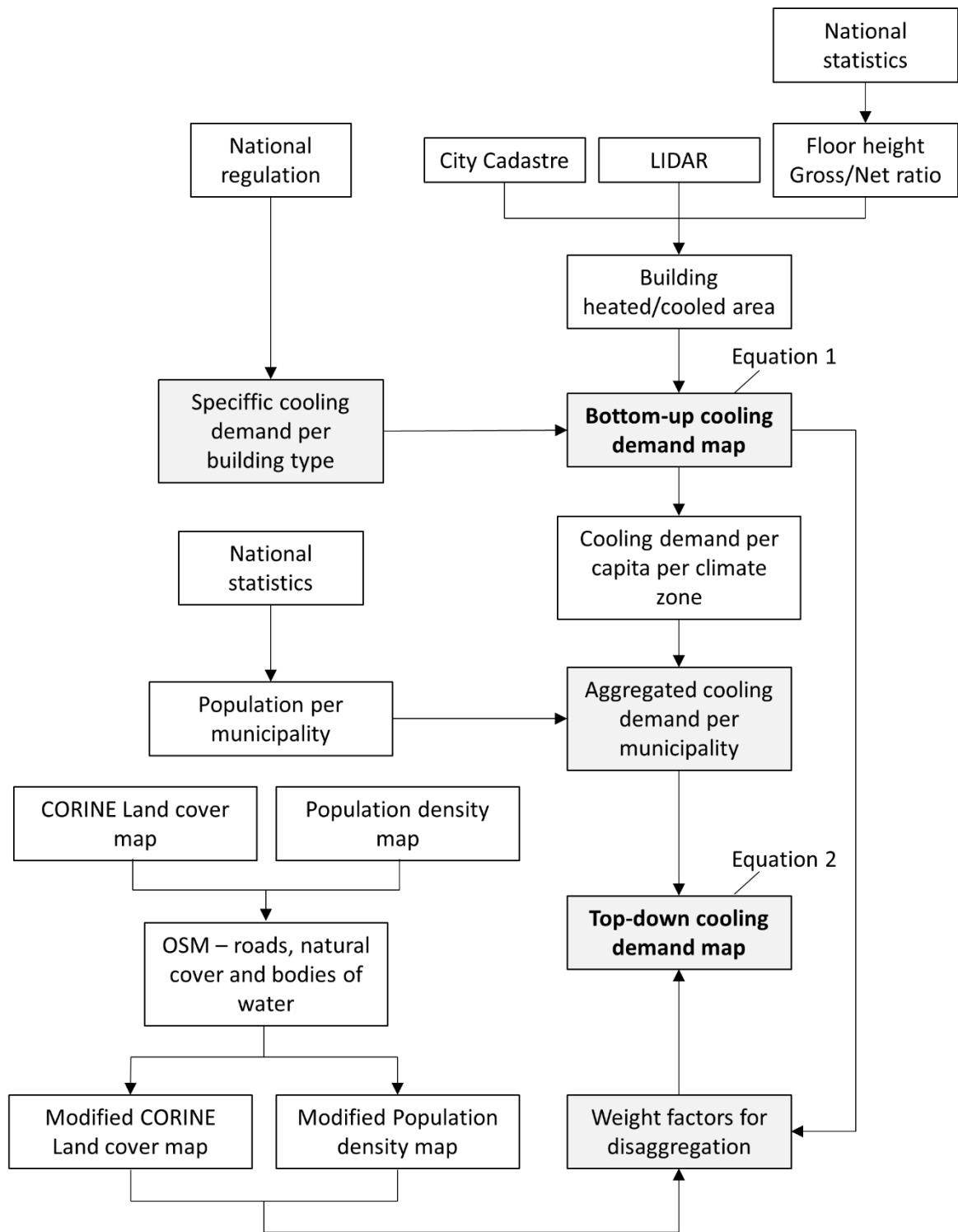
The focus of this research is the development and demonstration of a flexible method of cooling demand mapping and the assessment of district cooling potential which focuses on the use of public data. The proposed method is capable of mapping and assessing large areas such as regions and countries. The method has been implemented and validated on the cases of the City of Zagreb and the Republic of Croatia.

## **2. Methodology – Theory**

Spatial assessments commonly rely on large quantities of data, both georeferenced and not. Assessments of spatial energy demand often utilise detailed building censuses which incorporate data such as gross and/or net areas, use categories, age and energy categories based on a certification system. As such data is often not available, or is at least not public, certain approximations need to be utilized. The method proposed in this research relies mostly on publicly available data and data available to cities and municipalities. It consists of the following 4 steps:

1. Calculation of the specific cooling demand for the selected building types;
2. Bottom-up cooling demand mapping for the reference location;
3. Top-down cooling demand mapping and calibration via the reference location;
4. Assessment of the district cooling potential.

Figure 1 presents a graphical representation of the proposed method for the development of the bottom-up and top-down cooling demand maps. The method is described in depth in chapters 2.1 to 2.4.



**Figure 1 Graphical representation of the proposed method**



### ***2.1. Calculation of the specific cooling demand for the selected building types***

The specific cooling demand of buildings depends on a variety of factors such as the buildings use category, its physical characteristics and the local climate conditions. Due to this variety, it is impossible to utilize the same sets of parameters across multiple countries, or even across multiple regions. In the case of this research, the national technical regulations and algorithms for the calculation of the heating and cooling demands of reference buildings has been utilized. This involves the Technical Regulation on the rational use of energy and thermal protection in buildings (“Tehnički propis o izmjenama i dopunama Tehničkog propisa o racionalnoj uporabi energije i toplinskoj zaštiti u zgradama,” n.d.) and the Algorithm for the calculation of necessary energy for heating and cooling according to HRN EN ISO 13790 (Ministry of Physical Planning Construction and State Assets, n.d.).

The required inputs for the calculation of the cooling demand such as the geometry of the building envelope, reference physical characteristics, infiltration and temperature setpoints for the given climate zone, building use category and so on, have been taken from the relevant reference datasets which are available for most European countries and usually published by the relevant ministry. In the case of this research, the data has been taken from surveys conducted by the Ministry of Physical Planning, Construction and State Assets with the aim to make a comprehensive inventory of the existing national building stock (“Ministarstvo prostornoga uređenja, graditeljstva i državne imovine - Izvješća prema članku 5(2) Direktive 2010/31/EU i članku 6 Uredbe (EU) 244/2012 od 16.1.2012.,” n.d.).

### ***2.2. Bottom-up cooling demand mapping for the reference location***

Bottom-up cooling demand mapping involves detailed calculations at a very fine resolution and the subsequent aggregation of the obtained data into a predetermined grid. In the case of

this research, the cooling demand has initially been calculated on the level of individual buildings and then aggregated to a resolution of 1ha (square grid with 100m sides). The initial building level cooling demand for each individual building has been calculated using the following parameters:

- Footprint area;
- Total height of the building;
- Use category;
- Specific cooling demand per use category;
- Average floor height per use category;
- Net to gross surface area ratio per use category.

The cooling demand has been calculated using Equation 1. In essence, the equation represents a multiplication of the specific cooling demand of an individual building based on its type in kWh/m<sup>2</sup> and its net cooled area in m<sup>2</sup>.

$$CD = A \cdot NGR \cdot (H/H_F) \cdot CD_S / 1000 \quad \text{Equation 1}$$

CD – Total cooling demand [MWh/year]

A – Gross building footprint area [m<sup>2</sup>]

NGR – Net area to gross surface area ratio [-]

H – Total height of the building [m]

H<sub>F</sub> – Floor height [m]

CD<sub>S</sub> – Specific cooling demand [kWh/m<sup>2</sup>/year]

Due to the lack of quality reliable data on cooling demand, the parameters involved in the bottom-up calculation of the cooling demand have been calibrated and validated using national statistics on real estate areas and verifiable heat demand. This process includes the calibration

of NGR and  $H_F$  to the available data on surface areas of the specific building categories in the observed area as well as the calculated heating demand with the available aggregated heat demand data. As cooling is mostly provided through individual air to air heat pumps and cooling demand is rarely fully satisfied, there is no data available which the results of the calculations can be compared to. The cooling demand has been calculated for two climate conditions in the same area and the obtained results have been used to calculate a specific cooling demand per capita and per climate zone. This information has then been utilized to calculate the aggregated cooling demand for each individual municipality taking its climate zone into account.

### ***2.3. Top-down cooling demand mapping and calibration***

Top-down cooling demand mapping involves the distribution of aggregated demand over a defined grid using georeferenced data and weight factors. Depending on the availability of data, this process can involve small or large quantities of information of various levels of precision. When detailed data is not available, public databases can be utilised. In the case of this research, the top-down mapping has been conducted using the CORINE land cover maps (Copernicus, n.d.), a global population density map (JRC European Commission, n.d.) and the Open Street maps service (“OpenStreetMap,” n.d.).

The CORINE land cover map provides information on the dominant type of land cover over a predefined area. This includes both man-made structures and natural cover. The map does not provide information on the shares or detailed structures of the covers, it only provides the information on the type of the dominant one. This means that, for example, urban tissue is not presented as a mix of buildings, roads and green surfaces but only as one, usually buildings. Due to this limitation, the data obtained from this service needs to be adapted to increase the

precision of the overall mapping process. In the case of this research, the Open Street maps service has been utilized to remove roads, green areas and bodies of water from the identified man-made land covers and the result has been reshaped into a 1ha square grid and intersected with the borders of the municipalities.

The global population density map is based on night-time satellite images which record surface illumination. This has been proven as a good proxy for population density, however it often includes false data such as illuminated streets, parks and, in some cases, flares. To remove as many of these false data as possible, a similar approach has been applied as in the case of the CORINE land cover maps to enhance the precision of the inputs. Data obtained from the Open Street maps service has been utilized to remove roads, parks and bodies of water from the population density maps. The obtained map has been reshaped into a 1ha square grid and intersected with the borders of the municipalities.

Following the previous steps, the cooling demand of each individual grid tile has been calculated using Equation 2 **Error! Reference source not found..**

$$CD_i = \left( \sum_{n=1}^n AC_n \cdot Wf_{Cn} + P_i \cdot Wf_P \right) * \frac{CD_{mx}}{\sum_{m=1}^m (\sum_{n=1}^n AC_n \cdot Wf_{Cn} + P_m \cdot Wf_P)} \quad \text{Equation 2}$$

$CD_i$  – Cooling demand of grid tile i [MWh]

n – CORINE land cover categories [-]

$AC_n$  – Area of the modified CORINE land cover category n within grid tile i [ $m^2$ ]

$Wf_{Cn}$  – Weight factor for the CORINE land cover category n [ $1/m^2$ ]

P – Modified population density in one grid tile [-]

$Wf_p$  – Weight factor for the population density [-]

$CD_{mx}$  – Aggregate cooling demand for municipality x [MWh]

m – grid tile within municipality x [-]

The combination of the modified CORINE land cover and population density maps has been used to distribute the calculated aggregated cooling demand on a municipal level onto a 1ha grid, taking the climate categories of each municipality into account, together with a set of weight factors. The result of this process is a cooling demand map with a resolution of 1 ha covering the entire observed area. The weight factors used in the top-down method have been calibrated using the detailed bottom-up calculation for the reference location to minimize the overall error.

#### ***2.4. Assessment of the district cooling potential***

The potential for the utilization of district cooling depends on several technical and non-technical factors including but not limited to the existence of district heating and its operational parameters, availability of free cooling sources or potential heat sinks, local prices of labour and equipment and so on. In order to provide a general assessment of the potential, this research has focused on the assessment of the needed margins between the price the cooling energy can be sold for, and the cost incurred for its generation – LCOC (levelized cost of cooling). This margin is calculated using Equation 3

$$(CP - LCOC) \cdot CD_{1km} - L_{g1km} \cdot C_g = 0 \quad \text{Equation 3}$$

(CP-LCOC) – Difference between the price and the levelized cost of cooling [EUR/MWh]

$CD_{1km}$  – Cooling demand in a 1km radius [MWh/year]

$L_{g1km}$  – Length of the cooling grid in a 1km radius [m]

$C_g$  – Specific cost of the cooling grid [EUR/year/m]

The CP-LCOC value has been determined for each square thus resulting in a clear indication of priority areas for the commercially viable exploitation of district cooling. As 1ha is a relatively small area when district energy is concerned, the cooling demand in the case of this research has been aggregated from a distance of 1 km from each individual 1ha square. This way, the cooling demand potential is taking the situation of the surrounding area into account. The length of the roads and streets in the individual grid squares, again taken from the Open Street maps service, have been used as a proxy for the length of the necessary cooling grid. The lengths have again been aggregated from a distance of 1 km. Finally, in order to determine the cost of the grid per each observed square, the aggregated length has been multiplied by an annual grid cost which includes maintenance and the depreciation of the investment cost.

### **3. Case study – Calculation**

The presented method has been implemented on the case studies of the City of Zagreb (reference area and bottom-up cooling demand mapping) and Croatia (top-down cooling demand mapping and district cooling potential assessment). The City of Zagreb has been selected as the reference area for the detailed bottom-up mapping as it holds roughly 20% of Croatia's population (25% in the metropolitan area) and it has the highest availability of data needed for the implementation of the bottom-up mapping. The method for the bottom-up mapping involves the use of the city's cadastre and LIDAR recordings, all provided by the Office for Spatial Planning of the City of Zagreb, City Office for the Strategic Planning and Development of the City of Zagreb, City Office for Cadastre and Geodetic activities of the City of Zagreb as well as the City of Zagreb itself. The cadastre data has been used to determine each individual building's location, footprint area and use category while the LIDAR recordings have provided the total average height of each building. Using the information on

the ratios of total surface areas of individual building categories in urban areas in Croatia, found in the Long term strategy for the refurbishment of the building sector of Croatia (Ministarstvo graditeljstva i prostornog uređenja, 2014), the average floor heights and gross to net surface area ratios have been defined and calibrated. The result of this calibration is presented in Table 1.

**Table 1 Net to gross surface area ratios and floor heights for the reference case**

<b>Building type</b>	<b>(NGR) Net to gross ratio [-]</b>	<b>(H<sub>F</sub>) Floor height [m]</b>
Residential buildings	0.75	3.00
Commercial buildings	0.70	3.30
Public buildings	0.70	2.80

As no reference cooling demand data exists for either Croatia or the City of Zagreb, the validation of the results has been limited to the surface areas of the individual building categories. The shares of the Residential, Commercial and Public buildings according to (Ministarstvo graditeljstva i prostornog uređenja, 2014) are 67,14%, 23,85% and 9,01% respectively, while the bottom up mapping resulted in shares of 67,06%, 23,77% and 9,17%. The differences between the reference and bottom-up mapping data are less than 1%. For the purpose of this research, it has been assumed that the individual building's net heated area is equal to its net cooled area.

Following the method presented in chapter 2.1, the specific cooling demands of the individual building categories have been calculated both for Croatia's continental and coastal climates. The results of this calculation as well as the individual building categories can be found in Table 2. The specific cooling demands and net cooled areas per building have been used to

calculate the final cooling demand for the City of Zagreb. Since Croatia has two distinct climate zones, both sets of specific cooling demands have been used thus creating a real (continental) and virtual (costal) cooling demand map for Zagreb as well as the specific cooling demands per population asnd per climate type. Using this information and the total population of each municipality, the total cooling demand has been calculated for each one.

**Table 2 Specific cooling demand per building type and climate zone**

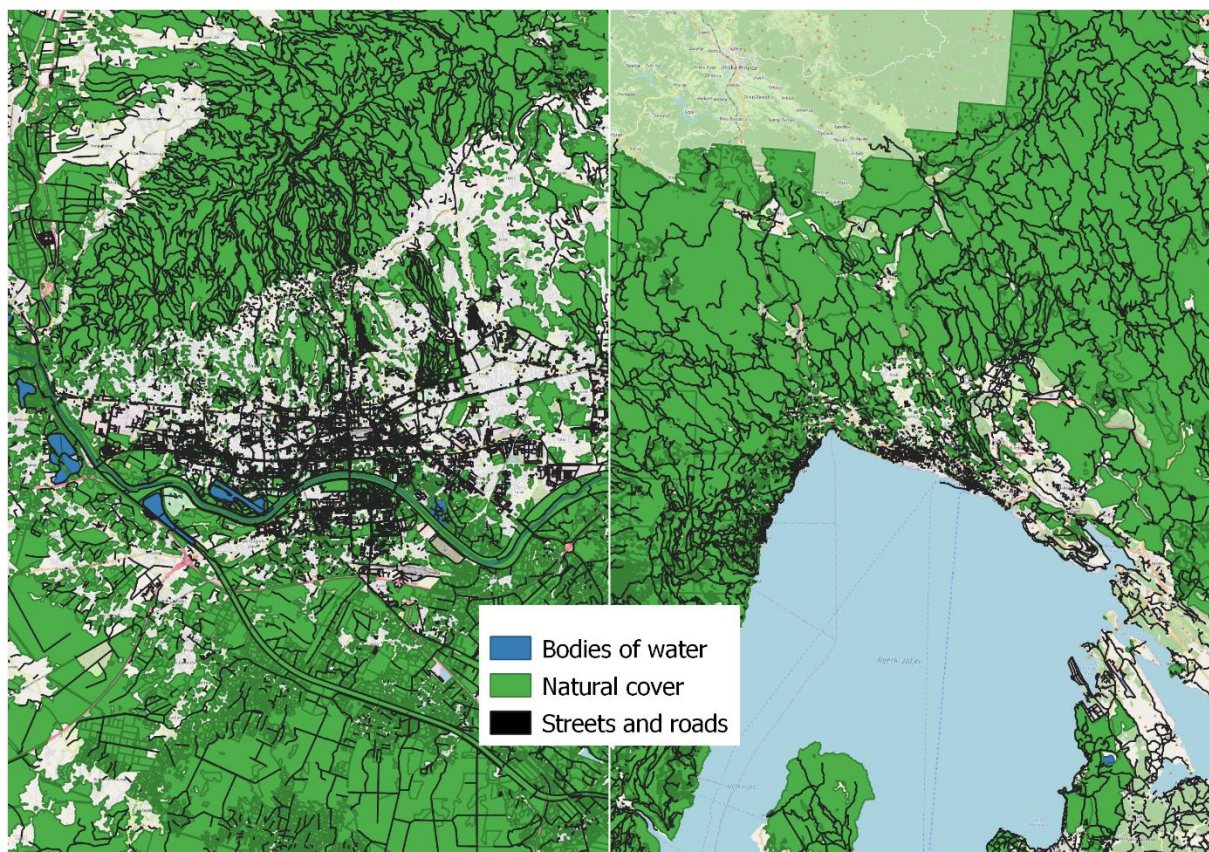
<b>Building type</b>	<b>Specific cooling demand - CD<sub>s</sub> [kWh/m<sup>2</sup>]</b>	
	<b>Continental</b>	<b>Coastal</b>
Multiapartment building	54	67
Single-family house	34	45
Office building	17	30
Schools/Universities/Kindergartens	45	45
Hospitality and tourism	80	92
Retail and wholesale buildings	8	18
Hospitals	82	95
Sports and recreation	10	10

As no detailed data, such as a building census or official spatial data on building or population density, energy demand and so on, exists for Croatia, publicly available spatial databases have been used. As mentioned in chapter 2.3, three key databases have been used in the process of top-down mapping:

1. CORINE land cover map (Copernicus, n.d.);
2. Global Human Settlement global population density map (JRC European Commission, n.d.);
3. Open Street maps service (“OpenStreetMap,” n.d.)

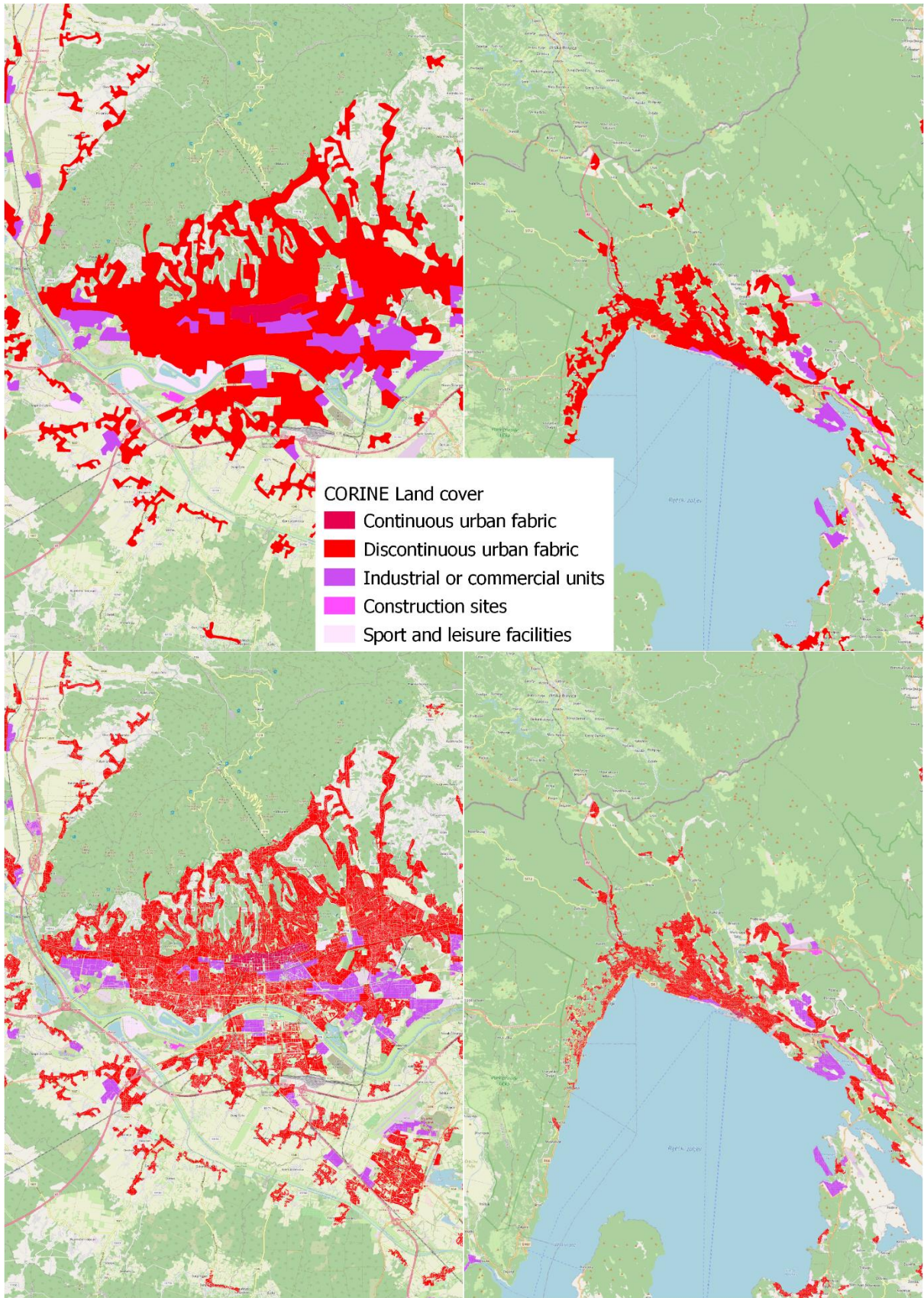


The qGIS (“QGIS project!,” n.d.) tool has been used in this research to implement all GIS related operations. As described previously, the datasets are not necessarily in the needed resolution and in some cases contain false data. Due to this, the inputs need to be modified and prepared for the use in the described method. This involves the removal of roads, bodies of water and natural cover from the land cover and population density maps as well as their recalculations into the municipal borders and the 1ha grid resolution. Figure 2 presents the bodies of water, natural cover and streets and roads to be removed from the land cover and population density maps for the City of Zagreb (continental climate) and City of Rijeka (coastal climate).

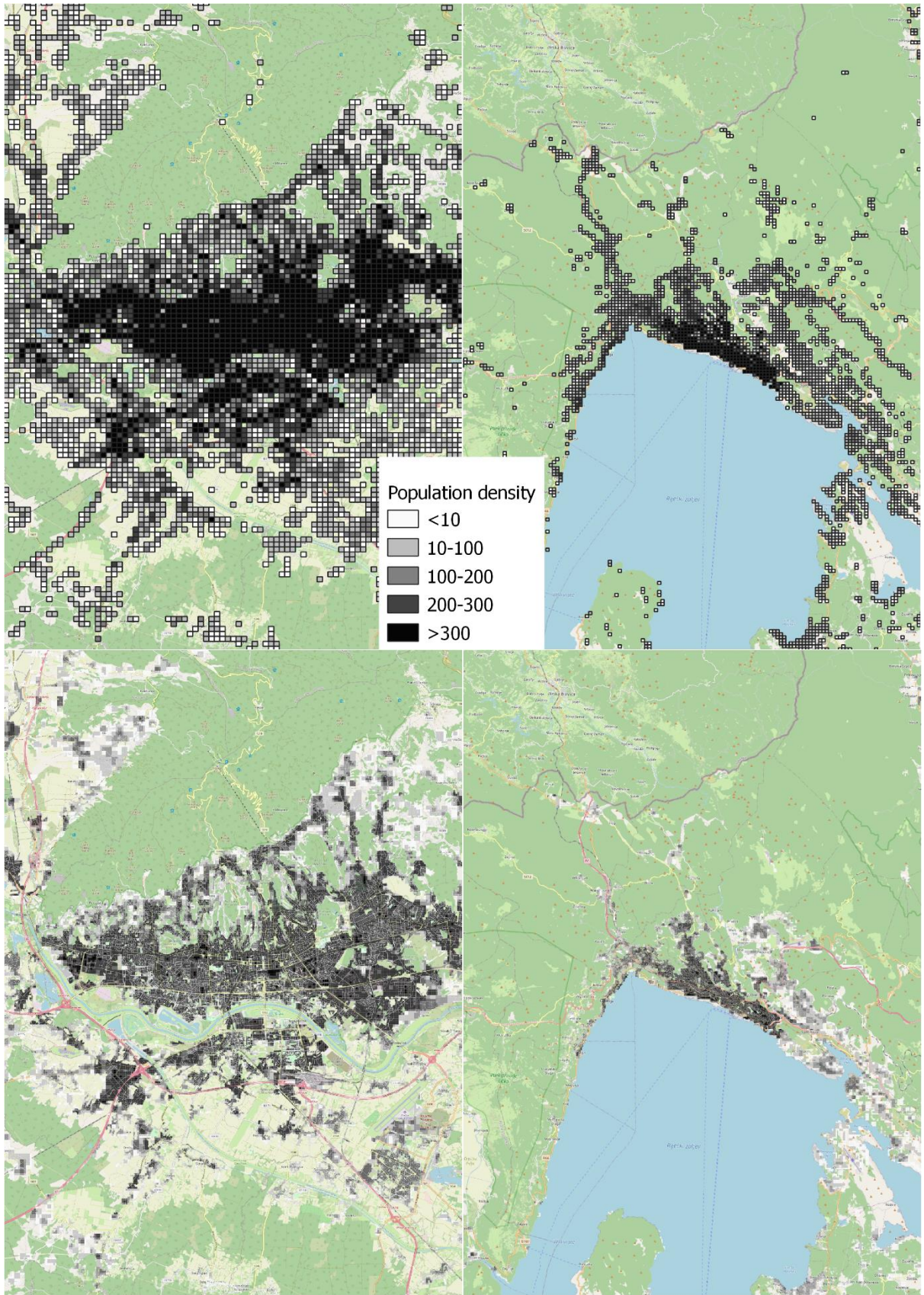


**Figure 2 Bodies of water, natural cover and streets and roads to be removed from the land cover and population density maps (Left: City of Zagreb, Right: City of Rijeka)**

Figure 3 and Figure 4 present the original and modified CORINE land cover and population density maps for the same two locations as Figure 2. As it can be seen, the modified maps include gaps in locations which are not covered by buildings, such as streets and roads, natural cover and bodies of water.



**Figure 3 CORINE land cover map (Top left: City of Zagreb, Top right: City of Rijeka) and modified CORINE land cover map (Bottom left: City of Zagreb, Bottom right: City of Rijeka)**



**Figure 4 Population density map (Top left: City of Zagreb, Top right: City of Rijeka ) and modified population density map (Bottom left: City of Zagreb, Bottom right: City of Rijeka)**

As the final step of the calculation, the data from the modified population density and CORINE land cover maps as well as the aggregated municipal level cooling demands have been added to a 1ha resolution grid. Weight factors have been assigned to each relevant category of the CORINE land cover map (Continuous urban fabric, Discontinuous urban fabric, Industrial or commercial units, Construction sites and Sport and leisure areas) and the population density and using these factors, the aggregated cooling demand of each municipality has been spatially distributed. The weight factors have been determined using an iterative process with the goal of minimising the sum of absolute differences between the individual cooling demands on a 1ha resolution calculated using the bottom-up and top-down methods.

Table 3 presents the final calibrated weight factors for the five relevant CORINE land cover categories and for the population density.

**Table 3 Final weight factors**

<b>Category</b>	<b>Weight factor</b>
Continuous urban fabric	0,226
Discontinuous urban fabric	0,043
Industrial or commercial units	0,006
Construction sites	0,002
Sport and leisure areas	0,002
Population density	7,118

The calculated bottom-up and top-down cooling demand values have been added to a grid containing data on the length of roads within each 1 ha grid. Following that, the total top-down and bottom-up cooling demands as well as the lengths of roads within a 1km radius of the centroids of each 1 ha grid have been summed up into new data sets for the assessment of the viability of district cooling as per the method presented in chapter 2.4.

Table 4 presents a summary of the input data used to develop the top-down and bottom-up cooling demand maps for the purpose of this research.

**Table 4 List of inputs used in the development of the bottom-up and top-down cooling demand maps**

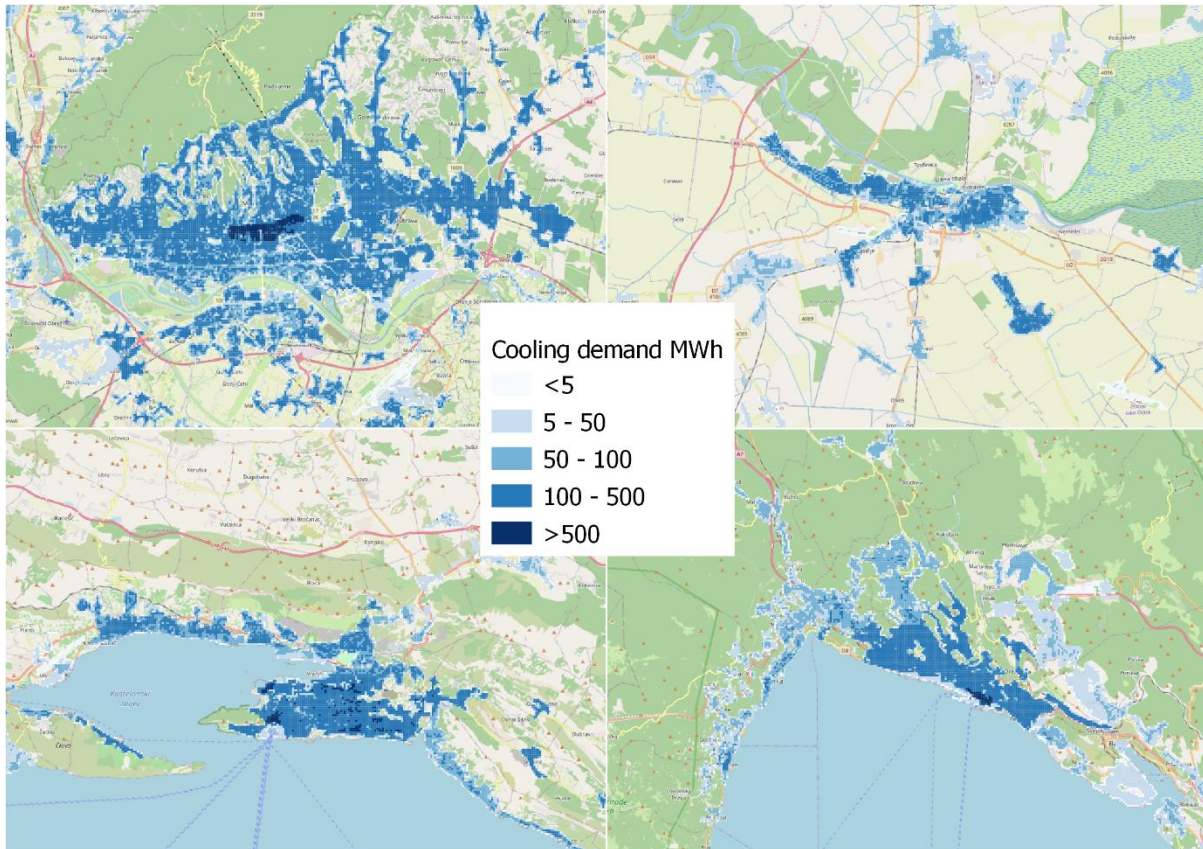
Input	File format	Comment
Digital cadastre of the City of Zagreb	.shp - georeferenced vector file	Data obtained from the data owner. Used to determine the location, type and footprint area of each building within the reference area.
LIDAR recordings of the City of Zagreb	.dwg – georeferenced raster file	Data obtained from the data owner. Used to determine the total average height of each individual building within the reference area.
Total population per municipality in Croatia	.csv – coma separated values	Publicly available data. Used to calculate the aggregated reference cooling demand of each municipality within the case study area.
Climate zone of each Croatian municipality	.csv – coma separated values	Publicly available data. Used to calculate the aggregated reference cooling demand of each municipality within the case study area.

CORINE Land cover map	.shp – georeferenced vector file	Publicly available data. Used to disaggregate the aggregated cooling demand from a municipal level to the final resolution.
Global Human Settlement global population density map	.dwg – georeferenced raster file	Publicly available data. Used to disaggregate the aggregated cooling demand from a municipal level to the final resolution.
Open street maps service – streets and roads	.shp – georeferenced vector file	Publicly available data. Used to modify the CORINE Land cover map and the Global Human Settlement global population density map.
Open street maps service – bodies of water	shp – georeferenced vector file	Publicly available data. Used to modify the CORINE Land cover map and the Global Human Settlement global population density map.
Open street maps service – natural cover	shp – georeferenced vector file	Publicly available data. Used to modify the CORINE Land cover map and the Global Human Settlement global population density map.

#### 4. Results and discussion

The final Top-down cooling demand map of Croatia at a resolution of 1 ha is presented in Figure 5. Examples of 4 Croatian cities are presented, 2 continental (top) and 2 costal (bottom).

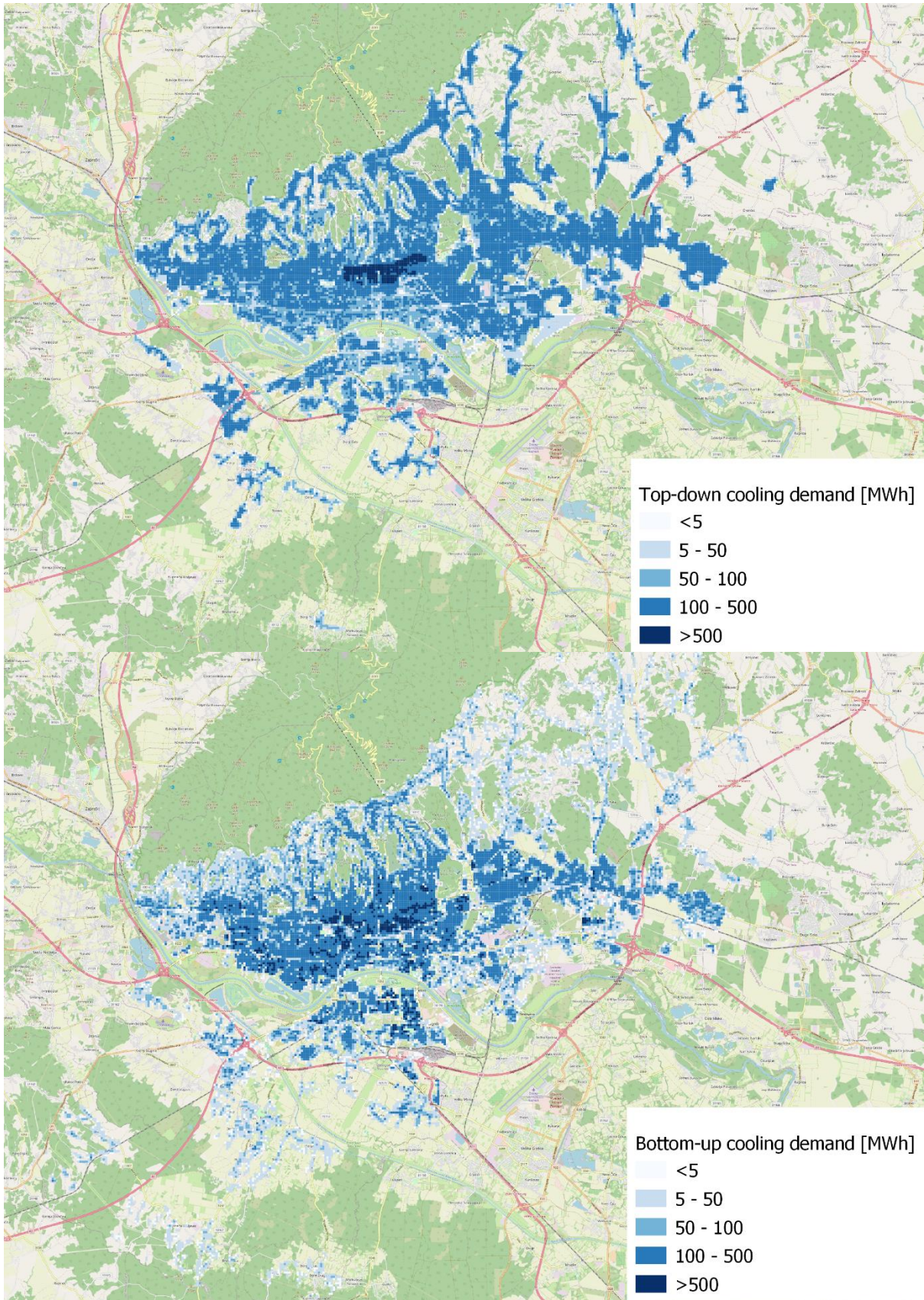




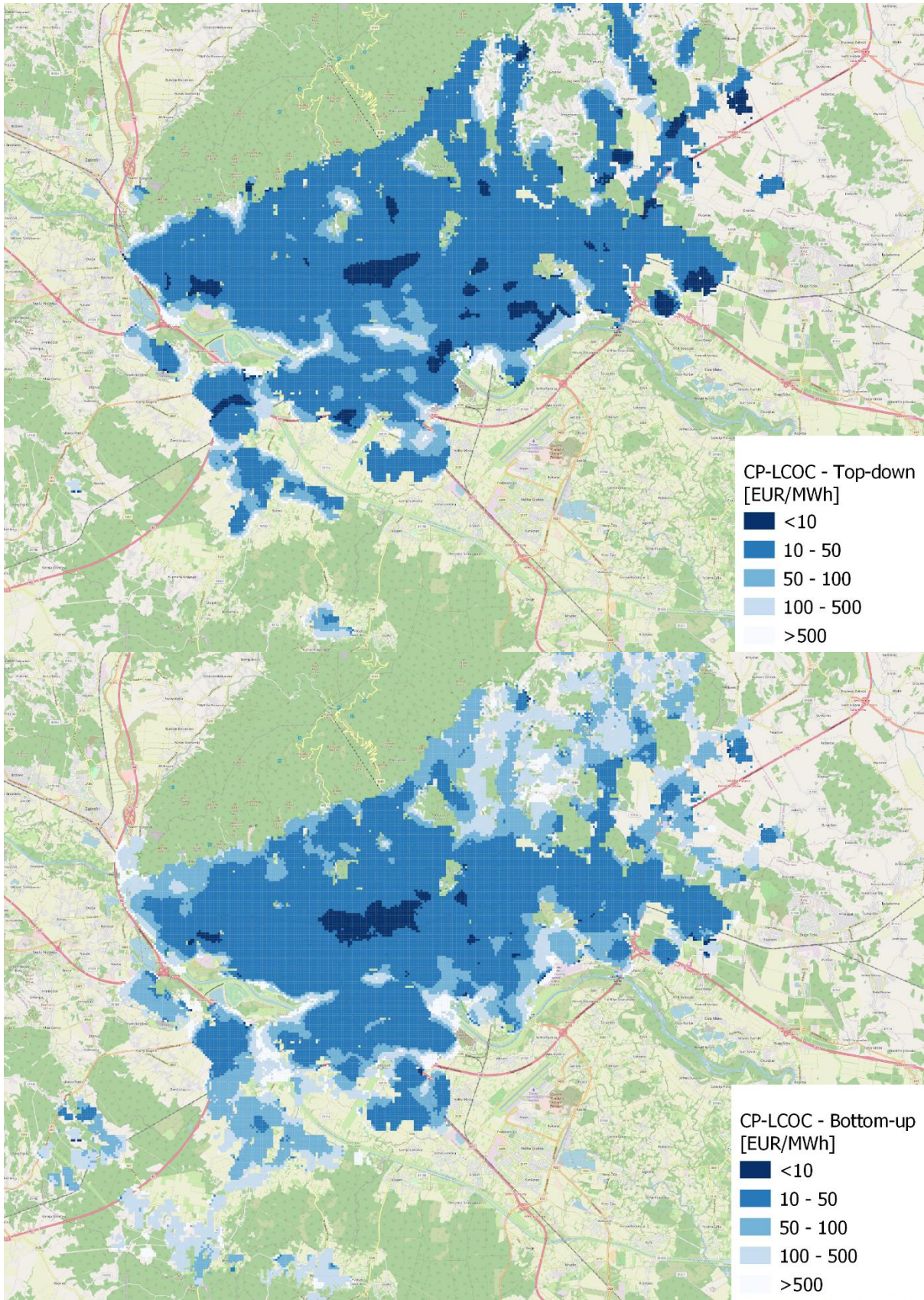
**Figure 5 Final Bottom-up cooling demand map (Top left: Zagreb, Top right: Osijek, Bottom left: Split, Bottom right: Rijeka)**

Figure 6 shows the comparison of the bottom-up and top-down cooling demand maps for the City of Zagreb. It is evident that the bottom-up map provides a more diverse distribution of the demand as seen from a less uniform distribution compared to the top-down. This is expected due to the diversity of the specific cooling demands for the various building categories as well as from the relatively flat distributions of the land use and population densities. Despite that, the top-down map has identified the locations of the cooling demand as well as the critical hotspots which should be investigated further. In order to assess the overall accuracy of the top-down map, the resulting potentials for the utilisation of district cooling have been compared for the case of the City of Zagreb using both mapping methods.

Figure 7 presents this comparison. The figure presents the CP-LCOC values calculated using the Top-down (top) and Bottom-up (bottom) methods assuming the cost of cooling network at 500 EUR/m. The values represent the margin, or the difference in the price of cooling compared to the levelized cost of cooling, needed for the system to be viable. Darker colours in the figure present locations in which district cooling is more viable. Some differences can again be spotted however the main trends have been captured well. The primary hot spot for district cooling potential has been well recognised in both cases (the city centre with the highest density of buildings and population). In order to assess the sensitivity of the results to the assumed distribution network cost, the calculation has been repeated at grid costs of 250, 500, 750 and 1.000 EUR/m of trench length. As the grid costs vary greatly depending on the pipe diameter, type of terrain the trench must traverse and the local costs of labour, a wide range of specific costs has been selected. According to (Möller, Wiechers, Persson, Grundahl, & Connolly, 2018), the grid costs can vary from 658,4 EUR/m to 1551.2 EUR/m for pipe diameters ranging from 0.1 to 0.3m in Sweden. The authors have confirmed, through informal conversations with representatives of the Croatian district heating operators, that the average prices for district heating grids in Croatia range from 200 to 1.000 EUR/m depending on the type of terrain and pipe diameter.



**Figure 6 Comparison of the top-down (top) and bottom-up (bottom) cooling demand maps for the City of Zagreb**



**Figure 7 Comparison of the viability of district cooling for the City of Zagreb (Top: Top-down, Bottom: Bottom-up)**

Table 5 presents the results of the sensitivity analysis as well as a comparison of the bottom-up and top-down mapping results. As expected, higher grid costs greatly reduce the viability of district cooling. For example, at a CP-LCOC level of 20 EUR/MWh, 72,10% of the total cooling demand in the City of Zagreb could be covered with district cooling if the grid cost equals 250 EUR/m. This goes down to 34,11%, 16,98% and 10,21% in the cases when the grid cost is increased to 500, 750 and 1.000 EUR/m respectively.

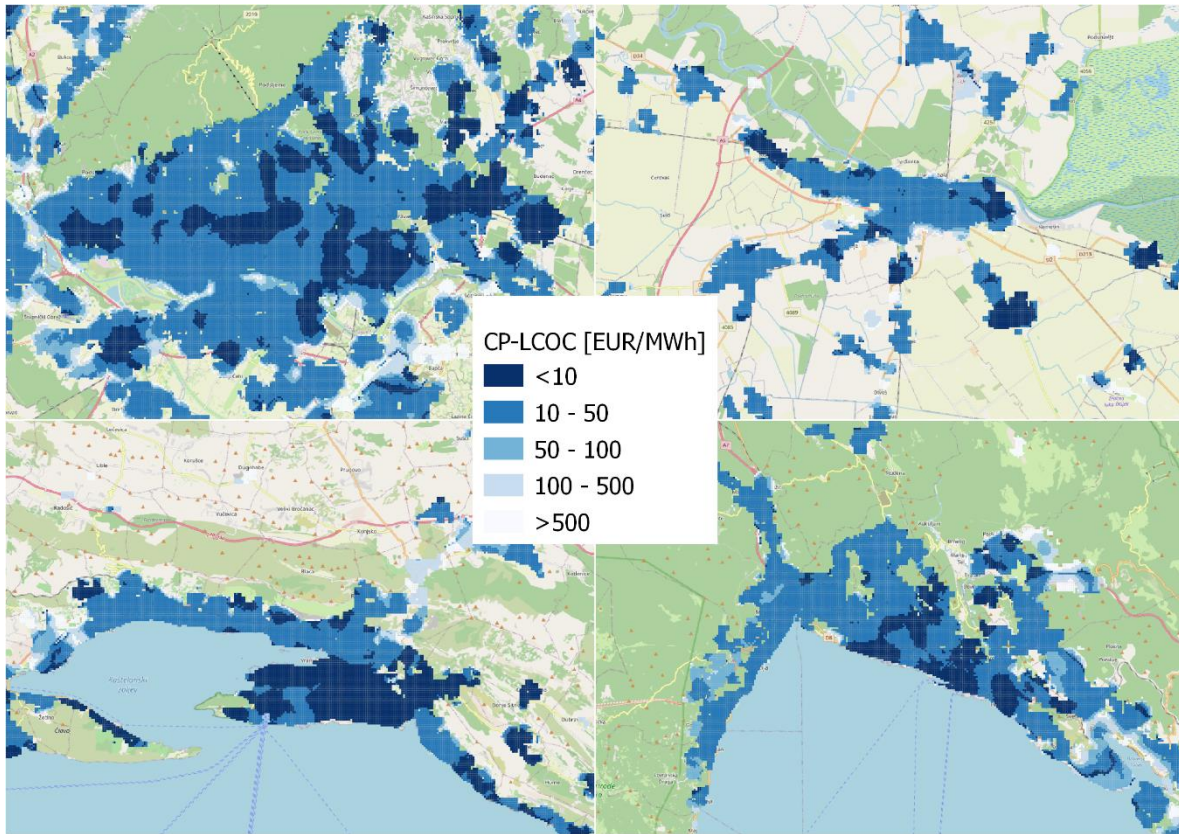
**Table 5 Sensitivity assessment off the viability of district cooling to the cost of the cooling network – Bottom-up and Top-down results for the City of Zagreb**

CP-LCOC [EUR]	250 EUR/m		500 EUR/m		750 EUR/m		1.000 EUR/m	
	BU	TD	BU	TD	BU	TD	BU	TD
<2	0,23%	0,36%	0,23%	0,07%	0,23%	0,04%	0,23%	0,02%
<5	10,21%	11,12%	0,24%	0,98%	0,23%	0,25%	0,23%	0,12%
<10	34,11%	41,71%	10,21%	11,12%	0,84%	3,83%	0,24%	0,98%
<20	72,10%	89,57%	34,11%	41,71%	16,98%	19,77%	10,21%	11,12%
<30	86,42%	97,58%	56,76%	73,86%	34,11%	41,71%	20,91%	24,81%
<50	95,41%	99,35%	80,68%	95,32%	62,65%	80,77%	44,80%	60,26%
<100	98,32%	99,85%	95,41%	99,35%	89,37%	98,27%	80,68%	95,32%
<200	98,79%	99,95%	98,32%	99,85%	97,13%	99,66%	95,41%	99,35%
<500	99,04%	99,99%	98,85%	99,96%	98,71%	99,93%	98,57%	99,89%
<1.000	99,10%	100,00%	99,04%	99,99%	98,92%	99,98%	98,85%	99,96%

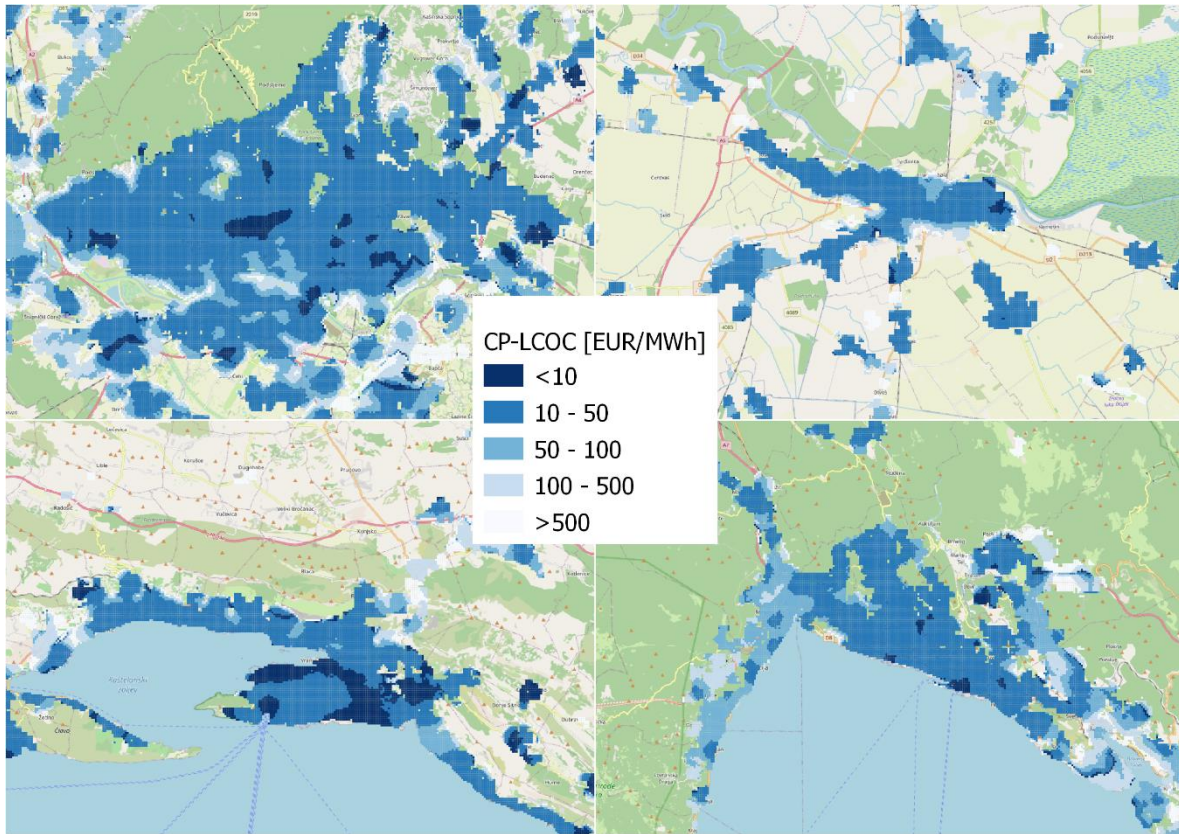
The comparison between the bottom-up and the top-down results presents a consistent overestimate of the viability of district cooling in the case of the top-down mapping. This is

evident as the values are higher across the board and especially when lower specific grid costs are utilized in the calculation, due to the stronger impact of the cooling demand, and with that the differences between the bottom-up and the top-down mapping methods, on the results. The difference between the two sets of values is reduced as the grid cost is increased. For example, at a CP-LCOC level of 20 EUR/MWh the bottom-up values for the share of cooling which is viable for district cooling equals 72,19%, 34,11%, 16,98% and 10,21% in the cases of grid costs of 250, 500, 750 and 1.000 EUR/m respectively. In the case of top-down, the values are 89,57%, 41,71%, 19,77% and 11,12%. Based on the observed differences, it is evident that the method is not suitable for detailed assessments for the purpose of the design of individual district cooling systems, however it is capable of identifying hot-spots of increased demand and potential for the exploitation of district cooling. This assessment can serve as a basis for further in-depth analysis of smaller areas which will in turn require high quantities of data and provide more precise findings.

Figure 8, Figure 9, Figure 10 and Figure 11 present the results of the assessment of the viability of district cooling for grid costs of 250 EUR/m, 500 EUR/m, 750 EUR/m and 1.000 EUR/m respectively, for four Croatian cities, two continental and two coastal. The results demonstrate both a strong impact of the grid costs and of the climate conditions on the overall viability of district cooling. The two coastal cities are both much smaller and less densely populated than Zagreb and they still maintain a much stronger and more consistent viability for district cooling as the grid costs increase.

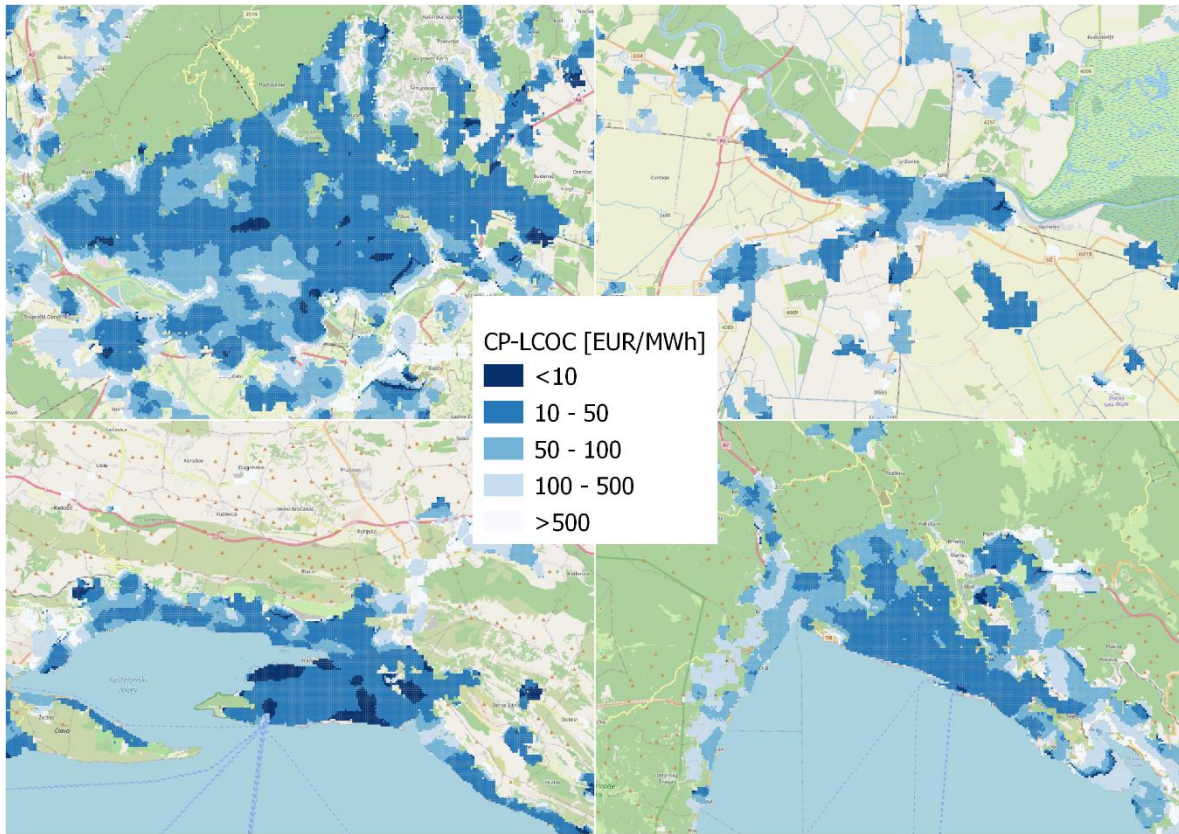


**Figure 8 Viability of district cooling at a grid price of 250 EUR/m (Top left: Zagreb, Top right: Osijek, Bottom left: Split, Bottom right: Rijeka)**

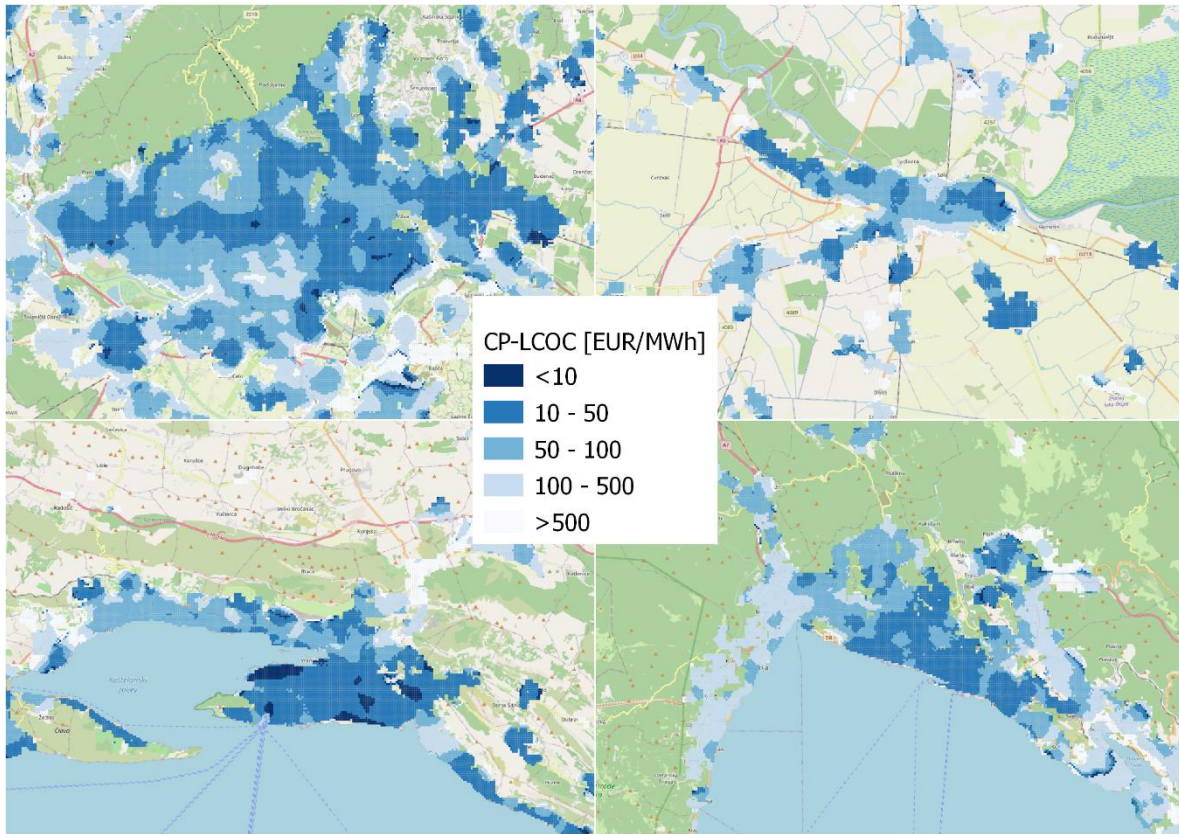


**Figure 9 Viability of district cooling at a grid price of 500 EUR/m (Top left: Zagreb, Top right: Osijek, Bottom left: Split, Bottom right: Rijeka)**





**Figure 10 Viability of district cooling at a grid price of 750 EUR/m (Top left: Zagreb, Top right: Osijek, Bottom left: Split, Bottom right: Rijeka)**



**Figure 11 Viability of district cooling at a grid price of 1000 EUR/m (Top left: Zagreb, Top right: Osijek, Bottom left: Split, Bottom right: Rijeka)**

Table 6 demonstrates the same results as the previous four figures. It presents a strong potential for the utilisation of district cooling in Croatia. At CP-LCOC levels of below 10 EUR/MWh, between 1,5 and 26,43% of the overall cooling demand in the country could be feasibly supplied by district cooling, depending on the grid costs. These shares increase to a range of 15,76 to 87,86% if the level is increased to 30 EUR/MWh.

**Table 6 Results of the assessment of the viability of district cooling – Top-down results for Croatia**

CP-LCOC [EUR]	250 EUR/m	500 EUR/m	750 EUR/m	1.000 EUR/m
<2	0,98%	0,29%	0,17%	0,13%

<5	7,26%	1,50%	0,69%	0,42%
<10	26,43%	7,26%	3,05%	1,50%
<20	69,96%	26,43%	12,72%	7,26%
<30	87,85%	50,87%	26,43%	15,76%
<50	96,44%	81,30%	58,16%	39,09%
<100	99,11%	96,44%	90,59%	81,30%
<200	99,67%	99,11%	98,12%	96,44%
<500	99,91%	99,76%	99,58%	99,36%
<1.000	99,97%	99,91%	99,83%	99,76%

## 5. Conclusion

The decarbonisation of Europe's buildings is key to its long-term sustainable development. Although most of their energy demand is linked to space heating and the preparation of domestic hot water, the provision of energy for cooling is gaining importance, and with that so is the viability of district cooling. The research within this paper demonstrates a four-step approach for cooling demand mapping and the assessment of district cooling potential with an emphasis on the utilization of publicly available data. The method utilizes a combination of spatially distributed and aggregated datasets and a top-down and bottom-up approach to generate a 1ha resolution cooling demand map and a spatial assessment of the viability for the utilization of district cooling of a large geographic area. The spatial assessment of the viability of district cooling utilizes the difference between the price of cooling and the LCOC instead of fixed costs and prices allowing for a great deal of flexibility in terms of local parameters such as technology, energy sources and prices. The presented method has been implemented on the case study of Croatia (top-down) and the City of Zagreb (bottom-up).

The results of the method do present a consistent overestimate of the potential for district cooling of the top-down compared to the bottom-up mapping; however, this is mostly evident in cases when the assumed cost of the district cooling grid is low (250 EUR/m in the case of this research) and when the price of cooling is only marginally higher than the LCOC. Overall, the method provides a flexible tool for the assessment of the viability of district cooling in various climate conditions and independent of the availability of high-quality local data. Although the method cannot provide the basis for the design of individual district cooling systems, it can serve as an initial assessment of a broad area for the identification of hot-spots of cooling demand and potential areas for the utilization of district cooling. The future work within this research will include the utilization of the identified potential for district cooling to assess its impact on the overall energy system as well as its potential integration with the heating and power sectors.

## References

- Alajmi, A., & Zedan, M. (2020). Energy, cost, and environmental analysis of individuals and district cooling systems for a new residential city. *Sustainable Cities and Society*, 54, 101976. <https://doi.org/10.1016/j.scs.2019.101976>
- ArcGIS. (n.d.). Retrieved October 7, 2019, from <https://www.arcgis.com/index.html>
- Connolly, D. (2017). Heat Roadmap Europe: Quantitative comparison between the electricity, heating, and cooling sectors for different European countries. *Energy*, 139, 580–593. <https://doi.org/10.1016/j.energy.2017.07.037>
- Copernicus. (n.d.). CORINE Land Cover — Copernicus Land Monitoring Service. Retrieved May 6, 2018, from <https://land.copernicus.eu/pan-european/corine-land-cover>
- Dutt, F., Quan, S. J., Woodworth, E., Castro-Lacouture, D., Stuart, B. J., & Yang, P. P. J. (2017). Modeling algae powered neighborhood through GIS and BIM integration. *Energy*

*Procedia*, 105, 3830–3836. <https://doi.org/10.1016/j.egypro.2017.03.896>

Equere, V., Mirzaei, P. A., Riffat, S., & Wang, Y. (2021). Integration of topological aspect of city terrains to predict the spatial distribution of urban heat island using GIS and ANN.

*Sustainable Cities and Society*, 69, 102825. <https://doi.org/10.1016/j.scs.2021.102825>

European Commission. (2019). *The Energy Performance of Buildings Directive Factsheet*.

Retrieved from

[https://ec.europa.eu/energy/sites/ener/files/documents/buildings\\_performance\\_factsheet.pdf](https://ec.europa.eu/energy/sites/ener/files/documents/buildings_performance_factsheet.pdf)

EUROPEAN COMMISSION. (2018). A European strategic long-term vision for a prosperous,

modern, competitive and climate neutral economy. Retrieved October 7, 2019, from

<https://eur-lex.europa.eu/legal->

[content/EN/TXT/HTML/?uri=CELEX:52018DC0773&from=EN](https://eur-lex.europa.eu/legal-content/EN/TXT/HTML/?uri=CELEX:52018DC0773&from=EN)

European Environment Agency. (n.d.). Time series of population-weighted heating and cooling

degree days averaged over Europe. Retrieved August 20, 2021, from

<https://www.eea.europa.eu/data-and-maps/daviz/trend-in-heating-and-cooling-2#tab-dashboard-01>

Fahlén, E., Trygg, L., & Ahlgren, E. O. (2012). Assessment of absorption cooling as a district

heating system strategy - A case study. *Energy Conversion and Management*, 60, 115–

124. <https://doi.org/10.1016/j.enconman.2012.02.009>

Groppi, D., de Santoli, L., Cumo, F., & Astiaso Garcia, D. (2018). A GIS-based model to assess

buildings energy consumption and usable solar energy potential in urban areas.

*Sustainable Cities and Society*, 40, 546–558. <https://doi.org/10.1016/j.scs.2018.05.005>

Hsu, C. Y., Lin, T. Y., Liang, J. De, Lai, C. H., & Chen, S. L. (2019). Optimization analysis of

waste heat recovery district cooling system on a remote island: Case study Green Island.

*Energy Conversion and Management*, 183, 660–670.

<https://doi.org/10.1016/j.enconman.2019.01.028>

Huang, J., Fan, J., & Furbo, S. (2019, July 1). Feasibility study on solar district heating in China. *Renewable and Sustainable Energy Reviews*, Vol. 108, pp. 53–64.

<https://doi.org/10.1016/j.rser.2019.03.014>

Huculak, M., Jarczewski, W., & Dej, M. (2015, May 10). Economic aspects of the use of deep geothermal heat in district heating in Poland. *Renewable and Sustainable Energy Reviews*,

Vol. 49, pp. 29–40. <https://doi.org/10.1016/j.rser.2015.04.057>

Jangid, J., Bera, A. K., Joseph, M., Singh, V., Singh, T. P., Pradhan, B. K., & Das, S. (2016, November 1). Potential zones identification for harvesting wind energy resources in desert region of India – A multi criteria evaluation approach using remote sensing and GIS.

*Renewable and Sustainable Energy Reviews*, Vol. 65, pp. 1–10.

<https://doi.org/10.1016/j.rser.2016.06.078>

JRC European Commission. (n.d.). Global Human Settlement. Retrieved October 7, 2019, from <https://ghsl.jrc.ec.europa.eu/index.php>

Lund, H., Duic, N., Østergaard, P. A., & Mathiesen, B. V. (2018). Smart Energy and District Heating: Special Issue dedicated to the 2016 Conference on Smart Energy Systems and 4th Generation District heating. *Energy*, 160, 1220–1223.

<https://doi.org/10.1016/j.energy.2018.07.012>

Meha, D., Thakur, J., Novosel, T., Pukšec, T., & Duić, N. (2021). A novel spatial–temporal space heating and hot water demand method for expansion analysis of district heating systems. *Energy Conversion and Management*, 234, 113986.

<https://doi.org/10.1016/j.enconman.2021.113986>

Ministarstvo graditeljstva i prostornog uređenja. (2014). *Dugoročna strategija za poticanje ulaganja u obnovu nacionalnog fonda zgrada Republike Hrvatske*. Retrieved from

<http://ec.europa.eu/energy/efficiency/>

- Ministarstvo prostornoga uređenja, graditeljstva i državne imovine - Izvješća prema članku 5(2) Direktive 2010/31/EU i članku 6 Uredbe (EU) 244/2012 od 16.1.2012. (n.d.). Retrieved June 20, 2021, from <https://mgipu.gov.hr/pristup-informacijama/zakoni-i-ostali-propisi/podrucje-energetske-ucinkovitosti/izvjesca-prema-clanku-5-2-direktive-2010-31-eu-i-clanku-6-uredbe-eu-244-2012-od-16-1-2012/8619>
- Ministry of Physical Planning Construction and State Assets. (n.d.). *Algorithm for the calculation of necessary energy for heating and cooling according to HRN EN ISO 13790*. Retrieved from [https://mgipu.gov.hr/UserDocsImages/dokumenti/EnergetskaUcinkovitost/meteoroloski\\_podaci/Algoritam\\_HRN\\_EN\\_13790\\_2017.pdf](https://mgipu.gov.hr/UserDocsImages/dokumenti/EnergetskaUcinkovitost/meteoroloski_podaci/Algoritam_HRN_EN_13790_2017.pdf)
- Möller, B., Wiechers, E., Persson, U., Grundahl, L., & Connolly, D. (2018). Heat Roadmap Europe: Identifying local heat demand and supply areas with a European thermal atlas. *Energy*, 158, 281–292. <https://doi.org/10.1016/j.energy.2018.06.025>
- Möller, B., Wiechers, E., Persson, U., Grundahl, L., Lund, R. S., & Mathiesen, B. V. (2019). Heat Roadmap Europe: Towards EU-Wide, local heat supply strategies. *Energy*, 177, 554–564. <https://doi.org/10.1016/j.energy.2019.04.098>
- Novosel, T., Pukšec, T., Duić, N., & Domac, J. (2020). Heat demand mapping and district heating assessment in data-poor areas. *Renewable and Sustainable Energy Reviews*, 131, 109987. <https://doi.org/10.1016/j.rser.2020.109987>
- OpenStreetMap. (n.d.). Retrieved October 7, 2019, from <https://www.openstreetmap.org/#map=7/50.510/4.475>
- Oró, E., Taddeo, P., & Salom, J. (2019). Waste heat recovery from urban air cooled data centres to increase energy efficiency of district heating networks. *Sustainable Cities and Society*, 45, 522–542. <https://doi.org/10.1016/j.scs.2018.12.012>
- Pampuri, L., Cereghetti, N., Strepparava, D., & Caputo, P. (2016). Analysis of the electricity

- consumptions: A first step to develop a district cooling system. *Sustainable Cities and Society*, 23, 23–36. <https://doi.org/10.1016/J.SCS.2016.02.015>
- QGIS project! (n.d.). Retrieved May 18, 2017, from <http://www.qgis.org/en/site/>
- Rahmouni, S., Settou, N., Negrou, B., & Gouareh, A. (2016). GIS-based method for future prospect of hydrogen demand in the Algerian road transport sector. *International Journal of Hydrogen Energy*, 41(4), 2128–2143. <https://doi.org/10.1016/j.ijhydene.2015.11.156>
- Shi, Z., Fonseca, J. A., & Schlueter, A. (2021). Floor area density and land uses for efficient district cooling systems in high-density cities. *Sustainable Cities and Society*, 65, 102601. <https://doi.org/10.1016/j.scs.2020.102601>
- Shi, Z., Hsieh, S., Fonseca, J. A., & Schlueter, A. (2020). Street grids for efficient district cooling systems in high-density cities. *Sustainable Cities and Society*, 60, 102224. <https://doi.org/10.1016/j.scs.2020.102224>
- Tehnički propis o izmjenama i dopunama Tehničkog propisa o racionalnoj uporabi energije i toplinskoj zaštiti u zgradama. (n.d.). Retrieved June 20, 2021, from [https://narodne-novine.nn.hr/clanci/sluzbeni/2020\\_09\\_102\\_1922.html](https://narodne-novine.nn.hr/clanci/sluzbeni/2020_09_102_1922.html)
- Thakar, K., Patel, R., & Patel, G. (2021). Techno-economic analysis of district cooling system: A case study. *Journal of Cleaner Production*, 313, 127812. <https://doi.org/10.1016/j.jclepro.2021.127812>
- United Nations. (2018). *2018 Revision of World Urbanization Prospects*.
- van Schijndel, A. W. M. J., & Schellen, H. L. H. (2018). Mapping future energy demands for European museums. *Journal of Cultural Heritage*, 31, 189–201. <https://doi.org/10.1016/j.culher.2017.11.013>
- Viesi, D., Galgaro, A., Visintainer, P., & Crema, L. (2018). GIS-supported evaluation and mapping of the geo-exchange potential for vertical closed-loop systems in an Alpine valley, the case study of Adige Valley (Italy). *Geothermics*, 71, 70–87.



<https://doi.org/10.1016/j.geothermics.2017.08.008>

- Yi, C. Y., & Peng, C. (2017). Correlating cooling energy use with urban microclimate data for projecting future peak cooling energy demands: Residential neighbourhoods in Seoul. *Sustainable Cities and Society*, 35, 645–659. <https://doi.org/10.1016/J.SCS.2017.09.016>
- Zyadin, A., Natarajan, K., Latva-Käyrä, P., Igliński, B., Iglińska, A., Trishkin, M., ... Pappinen, A. (2018, June 1). Estimation of surplus biomass potential in southern and central Poland using GIS applications. *Renewable and Sustainable Energy Reviews*, Vol. 89, pp. 204–215. <https://doi.org/10.1016/j.rser.2018.03.022>

# PAPER 6

# 1 Impact of district heating and cooling on the potential for the integration of 2 variable renewable energy sources in mild and Mediterranean climates

3 Novosel, T.<sup>1,\*</sup>, Feijoo, F.<sup>2</sup>, Duić, N.<sup>3</sup>, Domac, J.<sup>1</sup>

4 1=North-West Croatia Regional Energy Agency, Andrije Žaje 10, 10000 Zagreb. Croatia

5 2=School of Industrial Engineering, Pontificia Universidad Católica de Valparaíso, Valparaíso,  
6 Chile

7 3=University of Zagreb; Faculty of Mechanical Engineering and Naval Architecture,  
8 Department of Energy, Power Engineering and Environment, Ivana Lučića 5, 10002 Zagreb;  
9 Croatia

10 \* = corresponding author, tnovosel@regea.org

## 11 Abstract

12 Europe's decarbonisation ambitions can't be achieved without the full and rapid  
13 decarbonisation of its buildings which represent over 36% of its greenhouse gas emissions,  
14 the majority of which are linked to space heating and domestic hot water preparation. District  
15 heating, and in recent times, cooling must play a large role in satisfying this demand, especially  
16 in densely populated urban areas which already hold over half of the World's population.  
17 Besides the decarbonisation potential linked to heating and cooling production, these systems  
18 hold a strong potential for increased flexibility in the power sector using power to heat  
19 technologies thus increasing the potential for the utilization of intermittent renewables such  
20 as wind and solar. The goal of this research is to demonstrate the impact district heating and  
21 cooling can have on the potential for the utilization of intermittent renewable electricity  
22 sources in mild and Mediterranean climates, which traditionally have lower shares of district  
23 energy systems. Additionally, this paper presents the newly implemented capabilities of the  
24 H2RES linear optimization tool to model district cooling systems alongside the existing  
25 capacity to model district heating systems. The results demonstrate a significant capacity of  
26 district heating and cooling systems to act as demand response tools thus greatly increasing  
27 the potential for the utilization of wind and PV for electricity generation. In some scenarios,  
28 up to 73% of the total electricity demand could be covered with wind and PV and a production  
29 of excess electricity of only 5% on an annual basis. The Republic of Croatia has been used as a  
30 case study for this research.

31

## 32 Highlights:

- 33
- 34 • District heating and cooling play a vital role in the EU's decarbonisation effort
  - 35 • The H2RES tool has been upgraded to including district cooling
  - 36 • Power to heat is a valuable demand response tool
  - 37 • Wind and PV could cover up to 73% of Croatia's electricity demand in some scenarios
  - 38 • District cooling has a significant positive impact on the reduction of curtailment

39 **Key words:** Energy planning, District heating, District cooling, System integration, Linear  
40 optimization

41

## Abbreviations

ATA	Air to air
-----	------------

ATW	Air to water
CEEP	Critical excess of electricity
CHP	Combined heat and power
DC	District cooling
DH	District heating
DHC	District heating and cooling
EU	European Union
HDAM	Hydroelectric dam
HPHS	Pump storage hydroelectric power plant
HROR	Run of river hydroelectric power plant
PV	Photovoltaics

42

43

### Nomenclature

C	Variable cost incurred by dispatching a given technology
CEEP	Generation of CEEP
CEEP_cost	CEEP cost
CO <sub>2</sub> Levels	Generation of CO <sub>2</sub>
CO <sub>2</sub> Price	CO <sub>2</sub> price
D	Capacity at which a given technology has been dispatched
eff	Energy efficiency of a given technology
FuelCost	Unit cost of fuel for a given technology
HSk	Unit capital cost for heat storage
Hsto	New installed capacity of heat storage
I	Cost of decommissioning of a given technology
Imp	New decommissioning of a given technology
Inv	New installed capacity of a given technology
K	Unit capital cost for a given technology, fixed across the duration of the scenario
NonFuelCost	Other variable costs incurred by dispatching a given technology
p	Time period, hour
R	Ramp up and down costs of a given technology
Ramp	Ramp up and down of a given technology
t	Technology
TC	Unit capital cost for a given technology, variable based on an annual technology cost curve
y	Year

## 44 1. Introduction

45 The successful achievement of the EU decarbonisation missions and targets by 2030 [1] and  
46 2050 [2] will greatly hinge on the successful decarbonisation of the heating and cooling  
47 sectors, as buildings represent the largest single energy consumer, 40%, and greenhouse gas  
48 emitter, 36%, across the EU [3]. The fact that 55% of the World's population already lives in  
49 densely populated urban areas and current projections show that this figure could increase to  
50 68% by 2050 [4], additionally highlights the need to address the issue of sustainable supply of  
51 heating and cooling. At present, energy supply for space heating and domestic hot water

52 preparation represents the largest energy demands in terms of total annual and peak loads in  
53 25 of 27 EU member states when heating, cooling and electricity demand is compared [5].  
54 However, the widespread electrification as well as increased cooling demand due to climate  
55 change [6] as well as the increase in purchasing power and living standards could change this  
56 in the future.

57 District heating (DH) and district cooling (DC) play a key role in the decarbonisation of buildings  
58 and even processes, especially in densely populated urban areas. The importance of DH in  
59 terms of enabling the utilization of various renewable energy sources such as solar [7] and  
60 geothermal [8] energy, heat pumps [9][10] as well as waste heat [11][12], for example from  
61 data centres [13], has been widely documented. Similarly, DC can enable the use of free  
62 cooling [14], waste energy [15], renewables such as solar energy [16] and help diversify energy  
63 supply for cooling [17]. It is also most suitable for densely populated urban areas where it can  
64 facilitate significant efficiency gains and decarbonisation [18][19][20]. Additionally, joint  
65 operation of district heating and cooling (DHC) can achieve higher efficiencies [21] and  
66 synergies through the exploitation of the same renewable sources such as solar [22] and  
67 geothermal [23].

68 The suitability of DHC greatly depends on the energy demand densities, availability of cheap  
69 energy sources and the overall setup of the respective energy system as a whole [24]. Even  
70 with these limitations, the potential for the commercially viable utilization of these systems,  
71 and especially DH is significant [25][26]. The results of our previous research for example  
72 demonstrate that, depending on the assumed network costs, DH could feasibly supply  
73 upwards of 50% of Croatia's heating [27] while DC could supply upwards of 25% of Croatia's  
74 cooling demand [28].

75 A key benefit of DH systems is their potential to provide flexibility to the overall energy system  
76 if correctly configured [29]. The use of power-to-heat technologies such as heat pumps, heat  
77 storage and combined heat and power (CHP) units can enable systems to interact with the  
78 power system and provide additional potential for the integration of variable renewable  
79 energy sources such as wind and solar [30][31]. For instance, in systems with a high share of  
80 such variable sources a critical excess of electricity production (CEEP) can become an issue and  
81 cause curtailment of production. Heat pumps and electric heaters can instead transform this  
82 electricity into heat and either distribute it via a DH network or store it for later use. At  
83 instances when a lack of electricity occurs, these systems can be switched off and stored heat  
84 can be used while CHP units can be engaged to produce additional power and heat which can  
85 be again either stored or supplied [32]. Such a configurations can provide benefits on both the  
86 heat and power markets and enable additional revenues and market opportunities to DH  
87 operators. This potential can be additionally exploited if DC is integrated into the overall  
88 system as well.

89 Although they possess significant potential for the exploitation of intermittent renewable  
90 energy sources such as wind and PV and for the utilization of DHC, territories in mild and  
91 Mediterranean climate zones are often underutilizing these potentials and are rarely  
92 addressed in current literature. The goal of this research is to demonstrate the impact of both  
93 DH and DHC on the potential for the uptake of intermittent renewable energy sources in mild  
94 and Mediterranean climates. This has been achieved through the use of a novel energy system  
95 modelling and optimization tool, H2RES [33], which has been further upgraded for this  
96 purpose. The Republic of Croatia has been used as a case study as it covers both climate zones.

## 97           **2. Methods and tools**

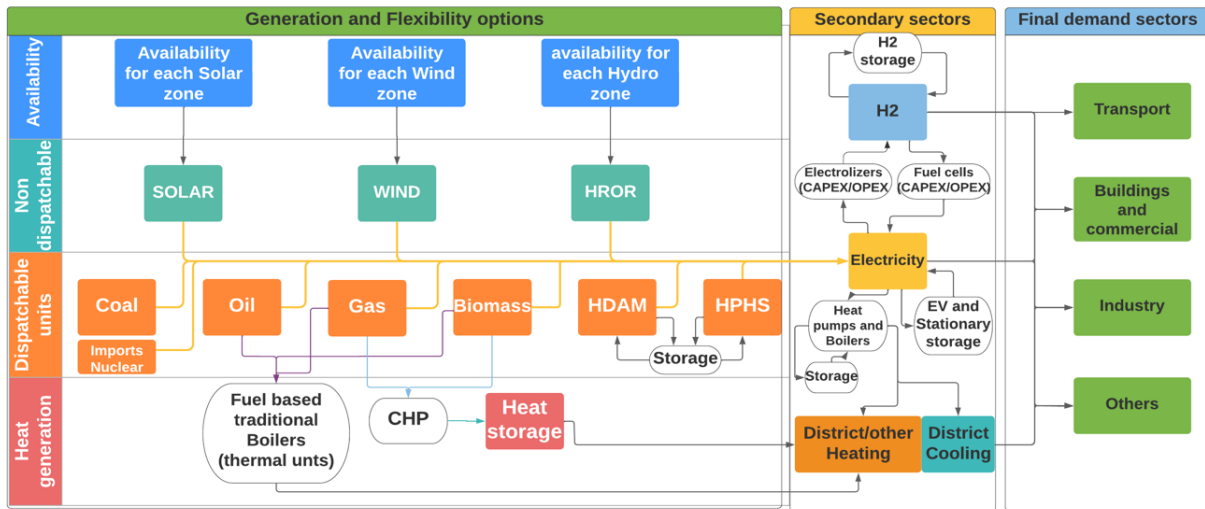
98   As the need for clean, renewable energy rises, solar and wind will play increasingly important  
99   roles in Europe’s energy systems. Their utilization will in turn require increasing energy storage  
100   and flexibility options to cope with their inherent intermittency. DHC systems, alongside the  
101   potential for the decarbonization of the heating and cooling sectors, can provide flexibility  
102   services using power to heat technologies and heat storage systems. In practice, this means  
103   that when excess electricity is generated by intermittent sources, it can be transformed into  
104   heat by electric boilers or heat pumps and either used or stored. These systems can also be  
105   turned off when a lack of electricity occurs, and stored heat can be used to satisfy the heating  
106   demand. Finally, if CHP plants are used, they can be turned on to generate electricity even  
107   when no heat is needed as it can again be stored easier and cheaper than electricity. The  
108   utilization of DC together with heat pumps to generate and even store cooling energy can  
109   further enhance these capacities due to the introduction of a higher energy demand in  
110   summer, when DH usually operates at lower capacities, and an overall higher energy demand  
111   throughout the year. This added flexibility allows for more intermittent energy sources to be  
112   added into an energy system while keeping CEEP at an acceptable level.  
113   The H2RES model has been used to assess the potentials of DH and DHC to reduce CEEP in  
114   systems with a high share of wind and solar energy. For this purpose, the model presented in  
115   [33] has been additionally upgraded with the capacity to model DC systems.

### 116           **2.1. The H2RES model**

117  
118   The H2RES model [33] is a long-term energy planning linear optimization model that considers  
119   hourly resolution scale for energy dispatch, while choosing optimal investment plans at a  
120   yearly level for all technologies considered in the planning strategy. H2RES is particularly  
121   developed to model and analyse the penetration of variable renewable sources in an energy  
122   system as well as sectoral coupling via Power-to-X technologies (PtX). Hence, H2RES enables  
123   the analysis of decarbonization strategies among the power, heating and cooling, transport,  
124   and industry sectors using Power-to-Heat, Power-to-EV, Power-to-Power, and Power-to-  
125   hydrogen technologies. The optimization performed minimizes the total cost incurred in  
126   supplying all demand carriers, including variable, capital, and policy costs. Figure 1 shows a  
127   general representation of the H2RES model. The H2RES model is built in Python and is solved  
128   using the GUROBI solver for linear optimization models.

129   H2RES considers three main set of decisions. First, it models yearly capacity investments  
130   (sizes) for all technologies (e.g., power plant size or H2 storage size). It then considers that  
131   when a capacity addition is made for a given technology, this addition becomes available at  
132   the beginning of the year. Also, H2RES follows this capacity over the planning years and  
133   performs a decommission (percentage of the capacity added) based on decommission curves  
134   predefined by the users. Secondly, given the capacity investment plans, H2RES models the  
135   dispatch for all technologies. Dispatch of the technologies is considered at an hourly resolution  
136   for every year of the planning horizon. The hourly resolution allows the user to better  
137   represent the relation between variable renewable sources and Power-to-X technologies. The  
138   dispatch of each technology is also subject to the initial capacity, capacity investments,  
139   availability factors (for variable sources) and the decommission that the technology suffers.  
140   The third set of decisions for H2RES corresponds to storage levels (hydro-dam, heat, H2, EV,  
141   and stationary batteries). Storage levels for each unit or technology, when available, are also  
142   represented with an hourly resolution for every year considered in the planning horizon and

143 are subject to maximum storage levels, defined by initial capacities, future investment, and  
 144 decommission curves.  
 145



146  
 147 **Figure 1: Representation of the H2RES model**

148 Investments, dispatch, and storage level decisions in H2RES are made with the main objective  
 149 of minimizing total annual discounted cost over the planning horizon (see Equation 1) subject  
 150 to a set of constraints. The cost minimization components are variable dispatch cost, capital  
 151 investment, ramp up-down costs of power plants, import costs, emissions costs, energy  
 152 transformation cost (e.g., cost of electrolysers) and the cost associated to CEEP. The cost  
 153 minimization is obtained while guaranteeing that a set of constraints are met. Such constraints  
 154 consider dispatch and technical constraints (e.g., ramp constraints of power plants), balancing  
 155 of supply and demand for all markets and hours (time periods), storage constraints, policy  
 156 constraints (e.g., CO2 limits, targets of renewable electricity, and/or CEEP limits) and  
 157 maximum-minimum penetration levels of certain technology options in different markets.  
 158 Note that H2RES allows the setting of limits on both CO2 emissions and CEEP levels, while it  
 159 also allows the user to assign costs to these parameters. Therefore, H2RES is designed to  
 160 assess scenarios in which both CO2 and CEEP levels are either penalized or limited by the  
 161 users.  
 162

$$\sum_y \sum_p \sum_t df_y [C_{t,p,y} D_{t,p,y} + TC_{t,y} K_t Inv_{t,y} + R_{t,p,y} Ramp_{t,p,y} + I_{p,y} Imp_{p,y} + CO_2 Price_y CO_2 Levels_{t,p,y} + CEEP\_cost CEEP_{t,p,y} + HSk_t Hsto_{t,y}] \quad \text{Equation 1}$$

163  
 164 The component  $C_{t,p,y} D_{t,p,y}$  in the objective function (Equation 1) represents the variable cost  
 165 ( $C_{t,p,y}$ ) incurred by dispatching ( $D_{t,p,y}$ ) a given technology (t), in a period or hour (p), and in year  
 166 (y). The variable cost,  $C_{t,p,y}$  (see Equation 2), considers the fuel cost and non-fuel cost, allowing  
 167 to account for different cost structures for distinct types of technologies. This component is  
 168 general across all technologies in H2RES, including the dispatch cost of power and DHC  
 169 technologies (e.g., electric boilers or heat-pumps). Similarly, the component  $TC_{t,y} K_t Inv_{t,y}$   
 170 represents the cost (K and TC) incurred by commissioning a given technology (power, heating  
 171 or cooling). The unit costs are separated into a fixed value across the duration of the entire  
 172 scenario (K) and a variable section dependent on annual cost curves (TC). The last term

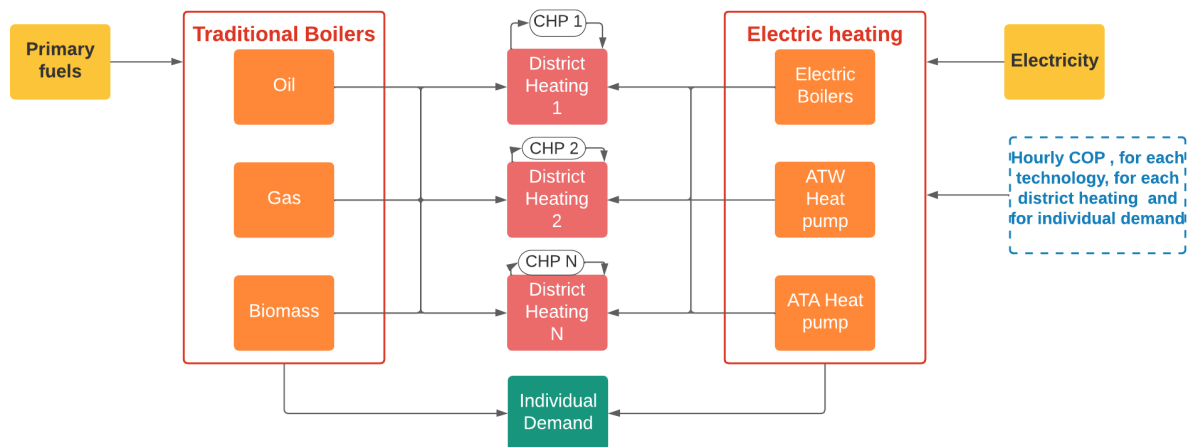
173  $HSk_t Hsto_{t,y}$  represents the capital investment cost (HSk) for heat storage (Hsto) in district  
174 heating networks.  
175

$$C_{t,p,y} = \left[ \frac{FuelCost_{t,p,y}}{eff_{t,p,y}} + NonFuelCost_{t,p,y} \right] \quad \text{Equation 2}$$

176  
177 Although the version of H2RES used in this research does not consider network flows (trade)  
178 among different regions (rather, it considers a national system), the model considers different  
179 heat and cooling demand curves for different zones within the system (see Table 1 for further  
180 details on input data and curves). Similarly, H2RES has the possibility to including the  
181 necessary number of wind and solar production zones within the national planning system. In  
182 this way, H2RES provides the option to assess the role of areas or regions with high or low  
183 capacity factors (assuming that transmission infrastructure is always available) with different  
184 availability profiles. Similarly, adding different demand zones (heat and cooling), each  
185 represented by an individual hourly profile (demand curves are exogenous and defined in the  
186 input data) allows the user to assess the electrification or decarbonization of heat and cooling  
187 systems with different characteristics (availability of DH, DC and DHC, availability of power-to-  
188 heat technologies, and integration of renewable energy with different demand profiles). Also,  
189 the introduction of different zones allows the consideration of different COP (coefficient of  
190 performance) as well as other efficiencies and losses associated to heat-pump technologies,  
191 influencing their ability to provide heat and cooling energy over seasons and day-night  
192 periods. Further details of the heat and cooling sectors in H2RES are described below.

193 H2RES differentiates between DH and individual heating demands. Both demand types can be  
194 supplied by a set of technologies, including traditional fuel boilers (coal, gas, biomass boilers),  
195 electric boilers, and different heat-pump technologies. Each of these technologies is defined  
196 by a set of technical characteristics, including variable cost, efficiencies, COP, and lifetimes,  
197 among others. In the case of DH demand, CHP plants are available. H2RES assumes that each  
198 CHP plant is connected to a DH system with heat storage that can be optimized (size and usage  
199 of heat storage). It also models losses in heat storage, input, output and losses among the  
200 time periods of the scenario, and in energy transformation processes. Additionally, H2RES  
201 allows the use of power to heat technologies through the introduction of Electric Boilers and  
202 Heat-pumps as well as heat storage. Additionally, there is no limit in terms of how many DH  
203 systems can be modelled with H2RES. Note that DH system are by default connected to CHP  
204 plants, however, if no CHP plant is to be considered, the capacity of such can be set to zero,  
205 removing this option from the system. A depiction of the heat sector in H2RES is shown in  
206 Figure 2.





207

208 **Figure 2: Representation of the Heating sector in H2RES**

209 For the purpose of this research, individual cooling demand and DC systems were developed  
 210 and incorporated into the base module of H2RES (not available in previous versions of the  
 211 model published in scientific literature). DC follows a similar modelling paradigm as DH. H2RES  
 212 considers different cooling demand profiles for different systems (representing different  
 213 regions, cities, or areas with independent cooling demands). It is assumed that heat-pump  
 214 technologies are available to meet cooling demand. Note that such heat-pump technologies,  
 215 if installed, also provide heat when heat demand in DH systems is present. Therefore, H2RES  
 216 optimizes the size (capacity) and usage of heat-pumps during both heating and cooling  
 217 seasons with the goal of minimizing total supply cost while considering the technical  
 218 characteristics of the different technologies (variable cost, losses, efficiencies, COPs, others).  
 219 Finally, as any technology in H2RES, heat pumps are also subject to decommission. Therefore,  
 220 if a long-term planning scenario is analysed, heat-pump for cooling systems can be replaced  
 221 for cheaper and more efficient technologies in future periods. It is important to note that  
 222 H2RES can model any technology for which the user can supply the needed inputs which  
 223 include the investment and other costs, efficiencies, ramp-up and down speeds and limits to  
 224 the installed capacities. The current version of the H2RES model does not take grid losses into  
 225 account, however they can be added as an additional demand. These functionalities will be  
 226 added in future versions.

227 **Table 1: Main input data files in H2RES**

Demand file	Definition/Parameter	Notes
Demand data	Electricity demand per demand sector	Hourly electricity demand profile for each year in MWh
Heat demand data	General demand	Hourly individual heat demand profile for each year in MWh
	Industry demand	Hourly industry heat demand profile for each year in MWh
	DH demand	Hourly DH demand profile per DH network for each year in MWh
Cooling demand data	DC zones	Hourly DC demand profile per DC network for each year in MWh

	General demand	Hourly individual cooling demand for each year in MWh
<b>H2 demand data</b>	Hydrogen demand per demand sector	Hydrogen demand for each period and year in MWh
<b>Fuel price data</b>	Fuel price	Variable (fuel) price of fuel for each of the fuels considered in H2RES.
<b>Availability factors</b>	availability factor	Availability factor for all non-dispatchable zones, including wind, solar and HROR zones
<b>Inflow data</b>	Water inflows	Water inflows (scaled to capacity) for each of the HDAM and HPHS units defined in the power generator data files.
<b>Import-export</b>	Import and export net transfer capacity	Imports net transfer capacity (MWh) are always required.

### 228 3. Scenarios and implementation

229 As stated in the introduction, The Republic of Croatia has been used as a case study for this  
 230 research. This Section provides details on the inputs and scenarios used in this process. It is  
 231 also important to note that, even though H2RES supports multi-year scenarios, this research  
 232 focuses on single-year scenarios meaning that some aspects of its functionalities, for instance  
 233 decommission, are not utilized.

234 As H2RES is not a computationally demanding model, the scenarios developed for the purpose  
 235 of this research have been implemented on a consumer grade laptop with an intel i7 processor  
 236 and 16 GB of RAM. Each individual scenario has been calculated in less than 5 minutes.

#### 237 3.1. Scope of the case study

238 The case study has considered the total electricity demand of the Republic of Croatia as stated  
 239 in [34]. The heating and cooling demands of 9 cities have been considered, out of the 556  
 240 cities and municipalities in Croatia. The cities have been selected based on their location and  
 241 size (6 largest continental/mild climate and 3 largest costal/Mediterranean climate cities) and  
 242 the consideration if they already have a DH system (8 of the 9 cities have a DH system of some  
 243 scale). There are currently no DC systems present in Croatia which also means that there are  
 244 none in the 9 selected cities. Table 2 presents the scope of the case study. The 9 selected cities  
 245 represent 37% of the total Croatian heating and 34% of the total Croatian cooling demand.  
 246 The heating demands have been taken from [27] and cooling demands have been taken from  
 247 [28].

248 **Table 2 Scope of the case study**

City	Heating demand MWh	Cooling demand MWh	Location	DH
<b>Zagreb</b>	8.257.006,82	2.121.063,25	Continental	Yes
<b>Osijek</b>	1.091.397,66	290.098,76	Continental	Yes
<b>Split</b>	928.099,75	606.437,04	Costal	Yes
<b>Velika Gorica</b>	655.852,50	170.538,14	Continental	Yes
<b>Rijeka</b>	653.951,94	437.963,20	Costal	Yes
<b>Slavonski Brod</b>	584.941,17	158.793,92	Continental	Yes
<b>Karlovac</b>	547.486,55	149.557,51	Continental	Yes

<b>Sisak</b>	464.509,38	128.251,98	Continental	Yes
<b>Zadar</b>	403.957,07	255.586,36	Costal	No
<b>Total</b>	13.587.202,83	4.318.290,16		
<b>Croatia</b>	36.288.855,02	12.521.269,96		
<b>Coverage</b>	37%	34%		

### 249 **3.2. Demand and supply distributions**

250 The hourly electricity demand for Croatia has been taken from [34]. The hourly space heating  
251 demand has been modelled for two climate zones, Continental based on the City of Zagreb  
252 and Coastal based on the City of Split using a degree hour analysis which resulting in two unit  
253 curves. The hourly domestic hot water demand has been taken from [35]. The final unit  
254 heating demands have been calculated using an 18% share of hot water demand against space  
255 heating demand for the Continental and 30% for the Coastal climates. The Continental share  
256 has been taken from real data available in the City of Zagreb while the Coastal share has been  
257 assumed considering the difference in overall heating degree days between Zagreb and Split.  
258 The hourly cooling demand distributions have been created as a combination of space cooling  
259 and baseline cooling demands and again for the same two climate zones based on Zagreb and  
260 Split. The baseline cooling demand has been created using the first week of the Gothenburg  
261 hourly DC demand distribution available in the EnergyPLAN model [36]. The space cooling  
262 demand has again been calculated as a degree hour analysis for two climate tones again  
263 represented by the City of Zagreb (continental) and City of Split (Costal). The final distribution  
264 has been created with an assumed share of the baseline demand of 60% in the Continental  
265 and 40% in the Coastal climates as no data is available for Croatia.  
266 The hourly supply distributions include the hourly electricity production from wind and solar  
267 and they have been taken from [37].

### 268 **3.3. Technical and economic parameters**

269 The following technical parameters have been used as inputs for the model:

- 270 1. Photovoltaics
  - 271 a. Hourly availability factor (0 – 1)
- 272 2. Wind powerplants
  - 273 a. Hourly availability factor (0 – 1)
- 274 3. CHP
  - 275 a. Electrical efficiency: 0,306
  - 276 b. Thermal efficiency: 0,647
  - 277 c. Power loss factor: 0,18
- 278 4. Heat pumps
  - 279 a. Heating COP: hourly model from [34]
  - 280 b. Cooling COP: hourly model from [34]
- 281 5. Heat storage:
  - 282 a. Storage self-discharge rate: 0,04

283 The investment costs for the technologies have been taken from [38]. Additionally, the system  
284 cost of CEEP has been set to 4.000 EUR/MWh

### 285 **3.4. Scenario creation**

286 To isolate and highlight the impact DH and the combination of DHC has on the potential for  
287 the utilization of intermittent renewable energy sources, two lines of scenarios have been  
288 developed:

- 289 1. DH plus renewable electricity generation;  
 290 2. DHC plus renewable electricity generation.

291 Renewable electricity generation in all scenarios means a combination of wind and PV  
 292 (photovoltaics) in four intervals, namely steps of 2.000, 4.000, 6.000 and 8.000 MW of both  
 293 wind and PV (for example in the 2.000 MW scenario this means 2.000 MW of wind and 2.000  
 294 MW of PV power simultaneously). These installed capacities and with that the hourly  
 295 production of electricity from intermittent renewable sources have been used consistently  
 296 across all scenarios. No additional electricity sources outside of the ones connected to the  
 297 DHC systems have been permitted.

298 The energy systems in the scenarios with DH were permitted to utilize CHP, heat pumps,  
 299 electric boilers and heat storage in order to satisfy the heating demand. In the scenarios with  
 300 cooling, heat pumps were the only allowed source of cooling.

301 This has resulted in the development of the following 7 scenarios presented in Table 3.

302 **Table 3 List of the developed scenarios**

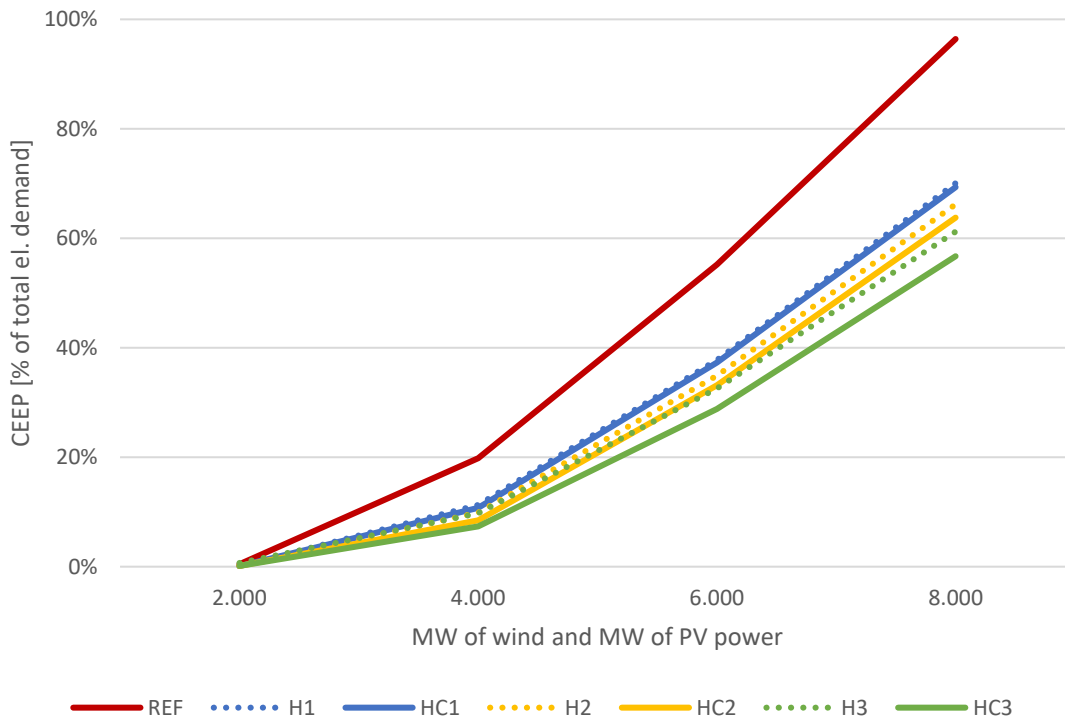
Scenario name	Description
REF	Reference scenario with no DH or DC
H1	DH share of 30% of total heat demand
H2	DH share of 50% of total heat demand
H3	DH share of 90% of total heat demand
HC1	DH share of 30% of total heat and DC share of 10% of total cooling demand
HC2	DH share of 50% of total heat and DC share of 30% of total cooling demand
HC3	DH share of 90% of total heat and DC share of 50% of total cooling demand

303 Additionally, each scenario except REF has been additionally tested with two limits to the use  
 304 of electric boiler as a source of heating and power to heat capacities. For this purpose, two  
 305 sub-scenarios have been created for the 6 scenarios with limits set to 600 MW and 2.500 MW  
 306 of electric boilers.

307 In all six scenarios with DH and/or DC, the heat capacity of the CHP units has been set to match  
 308 the peak heat demand in the individual systems so that the power to heat units can be  
 309 optimized to the electricity demand and not the heat demand as well.

#### 310 **4. Results**

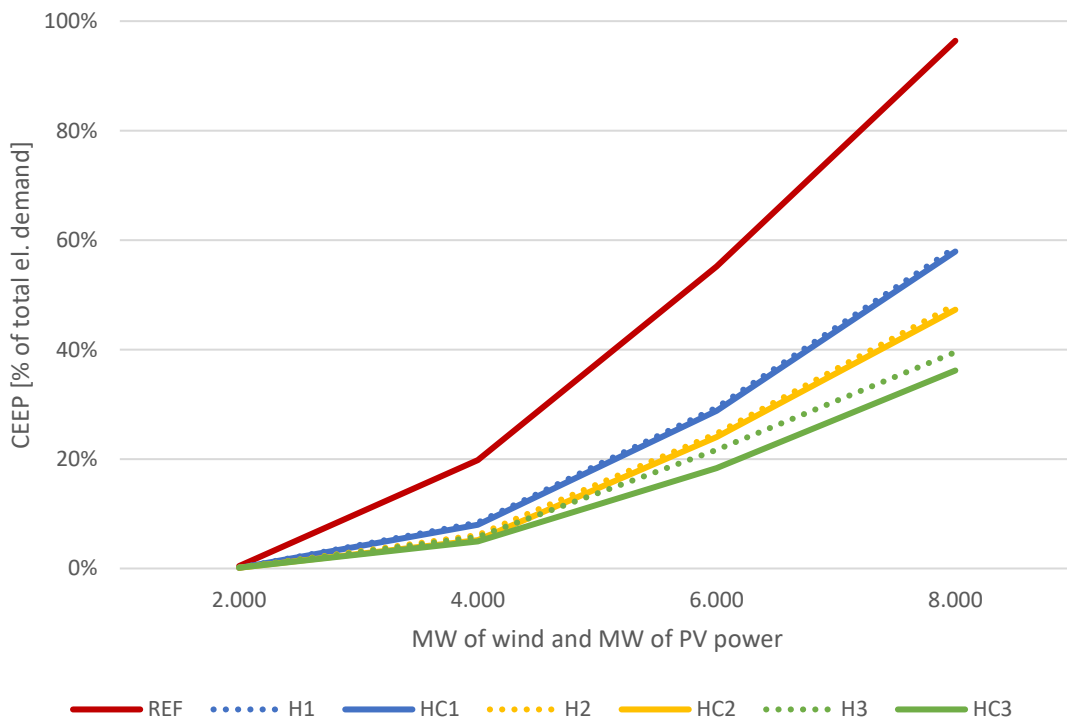
311 The results of the performed assessments can be seen in the figures and tables below. Figure  
 312 3 presents the results of all 7 scenarios including the reference and the 6 combinations of DH  
 313 and DC with a set limit for the use of electric boilers of 600 MW across all considered systems.  
 314 Figure 4 presents the same results but with the limit on electric boilers set to 2.500 MW.



315

316

**Figure 3 CEEP for all scenarios with electrical boiler limit of 600 MW**



317

318

**Figure 4 CEEP for all scenarios with electrical boiler limit of 2.500 MW**

319 Table 4 shows the CEEP of the reference scenario and the six scenarios which include DH  
 320 and/or DC with both electric boiler limits. It is evident from the presented results that the  
 321 increase in the DH and DC capacities impacts the potential for the utilization of intermittent  
 322 renewables favorably. If we compare the reference with any of the other six scenarios, we can  
 323 observe a sharp decline in CEEP. For instance, in the case of the highest installed capacity of

324 wind and PV power, 8.000 MW each, we can see that the CEEP is above 96% of the total  
 325 electricity demand. If we compare that to scenario HC3 we can see that the number drops to  
 326 roughly 57% in the case in which we limit the capacity of the electric boilers to 600MW total  
 327 across all system and to roughly 36% if we set the limit to 2.500 MW. We can also observe a  
 328 noticeable impact of DC on the reduction of CEEP across all cases. If we disregard the results  
 329 for the 2.000 MW of installed wind and PV as the CEEP is almost negligible, the average  
 330 reduction in CEEP when DC is added to the systems is close to 12%. Considering the relatively  
 331 small cooling demand compared to heating as well as the fact that DH was set to values  
 332 ranging from 30-90% compared to the 10-50% for DC, this can be considered a significant  
 333 impact. If we look at the results of HC3, the system could easily absorb 4.000 MW of wind and  
 334 4.000 MW of PV which would produce upwards 17,13 TWh of electricity with roughly 5% CEEP.  
 335 The total electricity demand in this case, including electricity for heat production, is 23,5 TWh,  
 336 meaning that wind and PV could cover 73% of the total electricity demand. In comparison, the  
 337 total electricity demand for the entirety of the Republic of Croatia is 18,32 TWh in the  
 338 reference case.

339 **Table 4 CEEP for all scenarios**

	Scenario	Installed wind and installed PV power [MW]			
		2.000	4.000	6.000	8.000
Max. el. boiler	REF	0,45%	19,81%	55,19%	96,41%
600 MW	H1	0,12%	11,27%	37,77%	70,06%
600 MW	HC1	0,11%	10,78%	37,30%	69,34%
600 MW	H2	0,14%	9,87%	34,93%	66,20%
600 MW	HC2	0,13%	8,46%	33,15%	63,77%
600 MW	H3	0,68%	9,76%	32,57%	61,21%
600 MW	HC3	0,14%	7,35%	28,80%	56,72%
2.500 MW	H1	0,12%	8,39%	29,42%	58,67%
2.500 MW	HC1	0,11%	7,96%	28,81%	57,91%
2.500 MW	H2	0,14%	6,14%	24,64%	48,23%
2.500 MW	HC2	0,13%	5,19%	24,03%	47,28%
2.500 MW	H3	0,20%	5,78%	21,65%	39,52%
2.500 MW	HC3	0,14%	4,94%	18,35%	36,17%

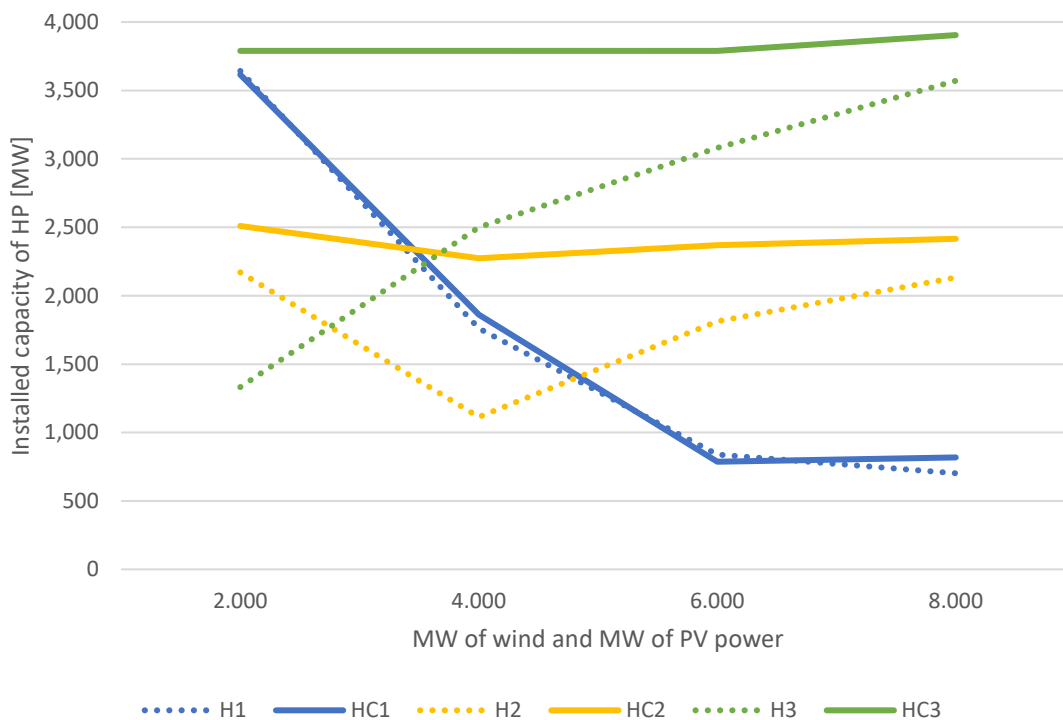
340  
 341 Table 5 and Figure 5 present the installed capacities of Heat pumps for all six scenarios with a  
 342 600 MW limit on electric boilers across all scenarios. Table 6 and Figure 6 present the same  
 343 results for a 2.500 MW limit. It is important to note that the installed capacities are aggregated  
 344 across all systems, however the model selects them per system and utilizes them only in the  
 345 one they are linked to. The utilization of Heat pumps varies across the scenarios, and it greatly  
 346 depends on the availability of electric boilers. Due to their lower investment price and lower  
 347 efficiency, the model prefers electric boilers at higher penetrations of intermittent renewables  
 348 as they are capable of absorbing more electricity at a lower cost. This is especially evident in  
 349 scenarios with a smaller share of DHC in which the system can't utilize the large amount of  
 350 heat which would be produced by efficient heat pumps so it chooses to gradually reduce  
 351 investments in heat pumps and replace them with electric boiler to utilize excess electricity.  
 352 This impact is less evident in larger systems which a higher heating and cooling demands. In  
 353 some of these cases, the investments into Heat pumps continue to increase, especially when  
 354 electric boilers are limited, to enable to utilization of the produced electricity. Heat pumps are

355 also essential in the scenarios with cooling as they are the only source of cooling the system  
 356 permits.

357 **Table 5 Installed capacity of Heat pumps [MW] for all scenarios with a 600 MW limit on electric**  
 358 **boilers**

	Installed wind and installed PV power [MW]			
Scenario	2.000	4.000	6.000	8.000
H1	3.643	1.761	839	702
HC1	3.615	1.861	787	817
H2	2.171	1.113	1.812	2.133
HC2	2.510	2.273	2.368	2.415
H3	1.332	2.500	3.081	3.570
HC3	3.789	3.789	3.789	3.904

359

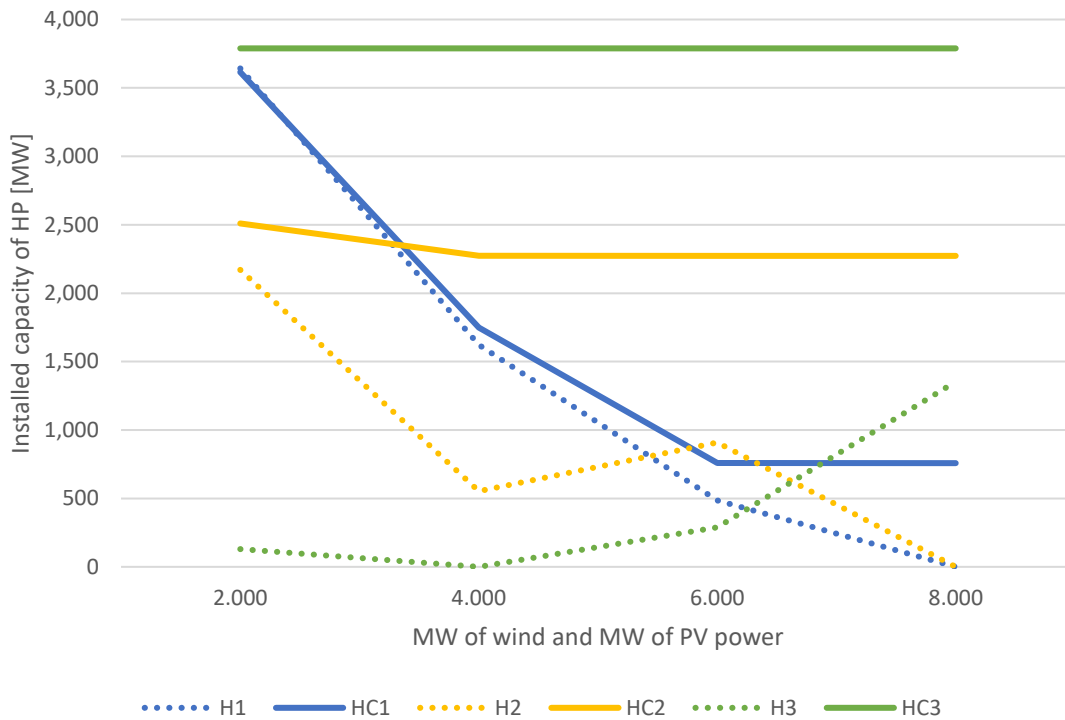


360

361 **Figure 5 Installed capacity of Heat pumps [MW] for all scenarios with a 600 MW limit on electric**  
 362 **boilers**

363 **Table 6 Installed capacity of Heat pumps [MW] for all scenarios with a 2.500 MW limit on electric**  
 364 **boilers**

	Installed wind and installed PV power [MW]			
Scenario	2.000	4.000	6.000	8.000
H1	3.643	1.623	484	0
HC1	3.615	1.749	758	758
H2	2.171	553	908	0
HC2	2.510	2.273	2.273	2.273
H3	131	0	288	1.353
HC3	3.789	3.789	3.789	3.789



366

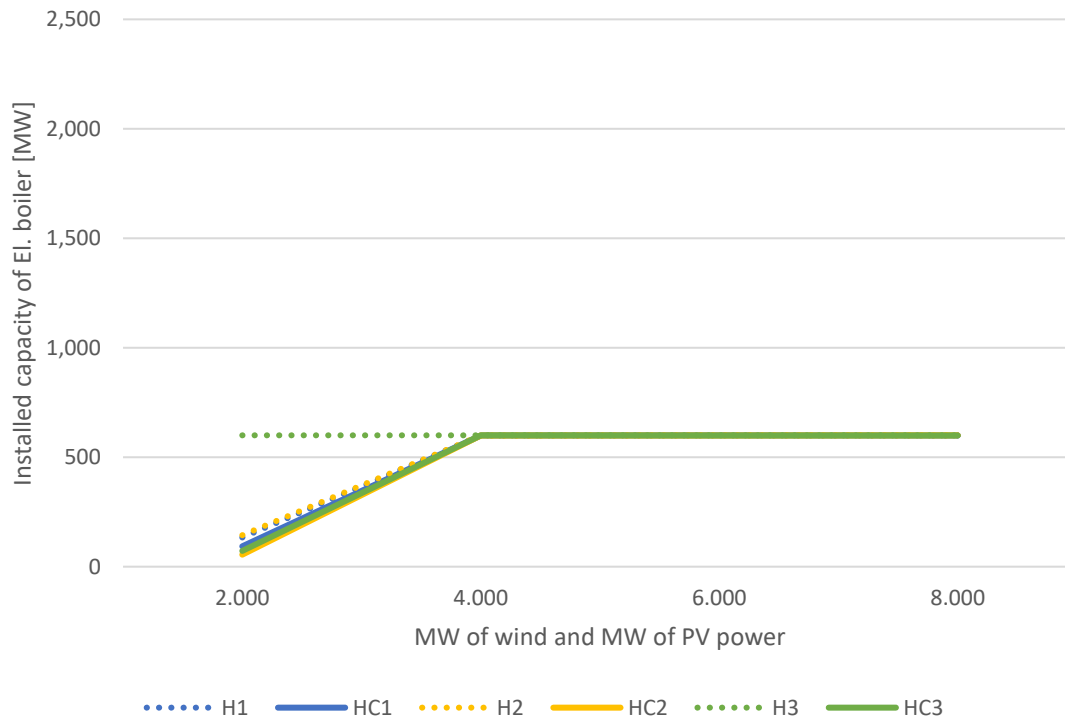
367 **Figure 6 Installed capacity of Heat pumps [MW] for all scenarios with a 2.500 MW limit on electric**  
 368 **boilers**

369 Table 7 and Table 8 as well as Figure 7 and Figure 8 present the investments into electric  
 370 boilers. As mentioned above, due to their low cost and low efficiency, the model prioritizes  
 371 them as a power to heat option. It can be seen that the model continuously increases the  
 372 investments into this technology up to the set limit as well as that the investments are lower  
 373 in the scenarios with DC. This is to be expected as heat pumps are the only available source of  
 374 cooling, so their utilization reduces the need for electric boilers.

375 **Table 7 Installed capacity of Electric boilers [MW] for all scenarios with a 600 MW limit on electric**  
 376 **boilers**

Scenario	Installed wind and installed PV power [MW]			
	2.000	4.000	6.000	8.000
H1	133	600	600	600
HC1	93	600	600	600
H2	144	600	600	600
HC2	55	600	600	600
H3	600	600	600	600
HC3	72	600	600	600



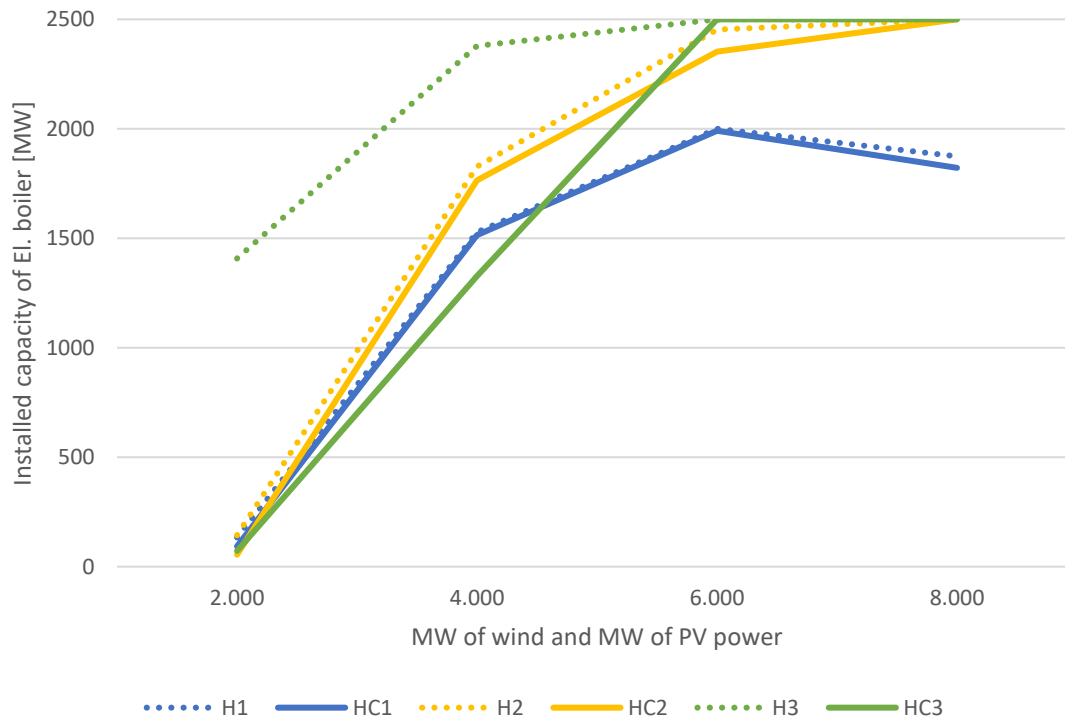


377

378 **Figure 7 Installed capacity of Electric boilers [MW] for all scenarios with a 600 MW limit on electric**  
 379 **boilers**

380 **Table 8 Installed capacity of Electric boilers [MW] for all scenarios with a 2.500 MW limit on electric**  
 381 **boilers**

Scenario	Installed wind and installed PV power [MW]			
	2.000	4.000	6.000	8.000
H1	133	1.528	2.000	1.875
HC1	93	1.515	1.991	1.822
H2	144	1.828	2.453	2.500
HC2	55	1.765	2.352	2.500
H3	1.408	2.379	2.500	2.500
HC3	72	1.327	2.500	2.500



382

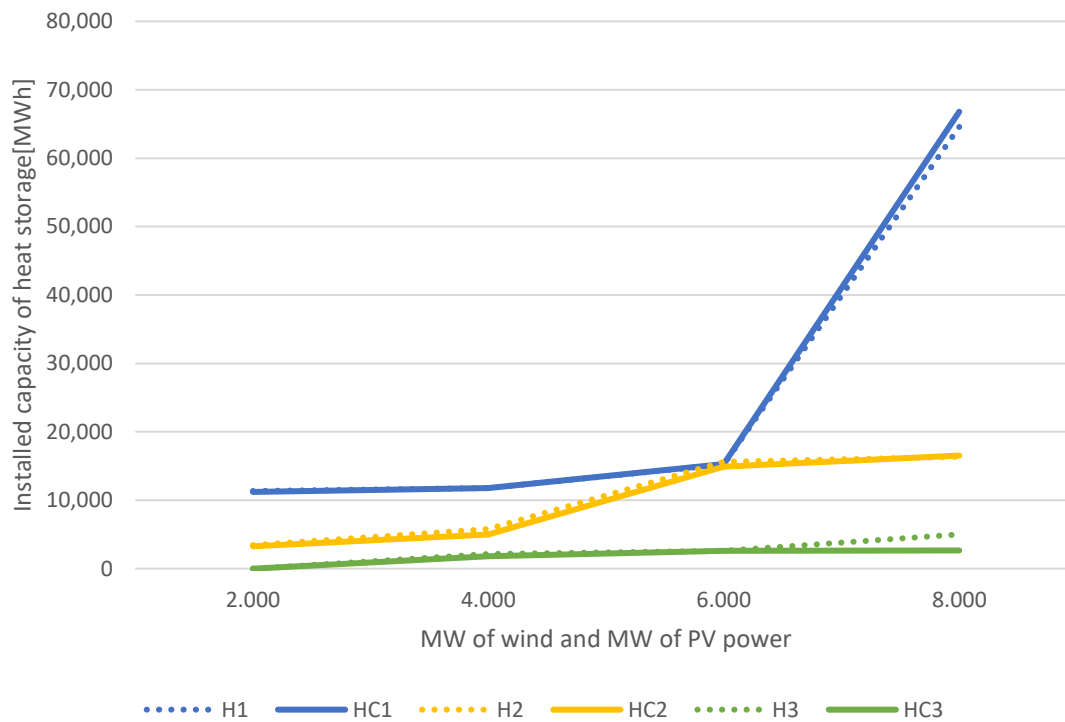
383 **Figure 8 Installed capacity of Electric boilers [MW] for all scenarios with a 2.500 MW limit on electric**  
 384 **boilers**

385 Finally, Table 9 and Table 10 as well as Figure 9 and Figure 10 present the installed capacities  
 386 of heat storage across all six scenarios and both electric boiler limits. It can be seen from the  
 387 results that, as expected, an increase in the penetration of intermittent sources increases the  
 388 need for energy storage. It is interesting to observe that higher shares of electric boiler led the  
 389 model to select higher storage capacities. This can be attributed to the fact that CEEP has not  
 390 been limited to a set value, but a cost has been attributed to it, meaning that at a certain level  
 391 of investments into a combination of heat pumps and storage, the model decided that it is  
 392 less costly to tolerate higher shares of CEEP than to continue investments into heat storage.  
 393 It can also be seen that higher shares of DHC also reduced the need for heat storage due to  
 394 the capacity of the larger systems to absorb more of the heat produced via power to heat  
 395 systems.

396 **Table 9 Installed capacity of Heat storage [MWh] for all scenarios with a 600 MW limit on electric**  
 397 **boilers**

Scenario	Installed wind and installed PV power [MW]			
	2.000	4.000	6.000	8.000
H1	11.352	11.781	15.261	64.569
HC1	11.217	11.781	15.298	66.787
H2	3.446	5.772	15.603	16.352
HC2	3.274	5.010	14.899	16.529
H3	0	2.158	2.628	5.010
HC3	0	1.796	2.615	2.664

398

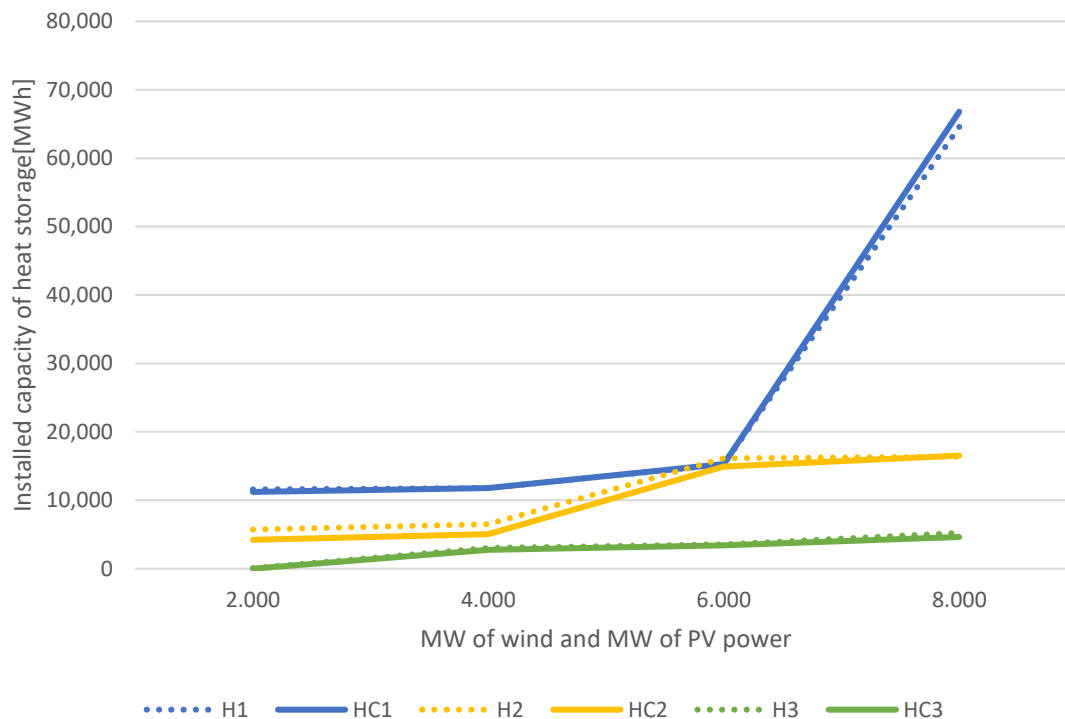


399

400 **Figure 9 Installed capacity of Heat storage [MWh] for all scenarios with a 600 MW limit on electric**  
 401 **boilers**

402 **Table 10 Installed capacity of Heat storage [MWh] for all scenarios with a 2.500 MW limit on electric**  
 403 **boilers**

Scenario	Installed wind and installed PV power [MW]			
	2.000	4.000	6.000	8.000
<b>H1</b>	11.585	11.781	15.261	64.569
<b>HC1</b>	11.217	11.781	15.298	66.787
<b>H2</b>	5.724	6.513	16.124	16.352
<b>HC2</b>	4.221	5.058	14.899	16.529
<b>H3</b>	76	3.056	3.526	5.227
<b>HC3</b>	0	2.750	3.425	4.633



404  
405  
406

**Figure 10 Installed capacity of Heat storage [MWh] for all scenarios with a 2.500 MW limit on electric boilers**

## 407 5. Conclusion

408 The research in this paper presents the capabilities of the upgraded linear optimisation tool  
409 H2RES to set-up and model energy systems which consist of one electricity system and several  
410 DH and DHC systems as well as the impact DH and DHC can have on the potential for the  
411 utilization of intermittent energy sources such as wind and PV.

412 The presented version of H2RES has been updated to incorporate DC as one of its demand  
413 streams. The tool can model one or several DC systems in parallel, all connected to same  
414 overall electricity network, same as its previous capabilities to model DH. Additionally, the  
415 DHC systems can be connected so that technologies, such as heat pumps, can satisfy both the  
416 heating and cooling demand if set up in such a way.

417 The tool has been utilized to model an energy system consisting of several DHC systems in  
418 Mediterranean and mild climates with a goal to assess their impact on the potential for the  
419 utilization of intermittent renewables. As can be seen from the results, the impacts are  
420 significant. When comparing the reference scenario with no DH or DC, we can see a sharp  
421 increase in the generation of CEEP of up to 96% of the total electricity demand in the case with  
422 8.000 MW of wind and 8.000 MW of PV. This figure drops to roughly 39% and 36% in the cases  
423 with the highest levels of DH (H3) and DHC (HC3). If we look at the HC3 scenario, we can see  
424 that at a level of 4.000 MW of wind and PV the CEEP is below 5% of the total electricity demand  
425 which includes the electricity consumption of power to heat technologies when generating  
426 heat. Wind and PV generate 17,13 TWh of the total 23,5 TWh of electricity consumed in this  
427 scenario meaning that these two sources could generate 73% of the total electricity demand  
428 while keeping CEEP below 5%. The reference electricity demand of the Republic of Croatia is  
429 18,23 TWh. The results also demonstrate a significant impact of DC on CEEP especially  
430 considering its low total demand compared to heating.

431 Overall, the presented research clearly demonstrates the positive impacts widescale DHC  
432 utilization can have on the potential for the penetration of intermittent sources for the  
433 generation of electricity if power to heat technologies are utilized.

## 434 **Acknowledgement**

435 This research did not receive any specific grant from funding agencies in the public,  
436 commercial, or not-for-profit sectors.

## 437 **List of references**

- 438 [1] "EU Mission: Climate-Neutral and Smart Cities | European Commission." [Online]. Available:  
439 [https://ec.europa.eu/info/research-and-innovation/funding/funding-opportunities/funding-](https://ec.europa.eu/info/research-and-innovation/funding/funding-opportunities/funding-programmes-and-open-calls/horizon-europe/eu-missions-horizon-europe/climate-neutral-and-smart-cities_en)  
440 [programmes-and-open-calls/horizon-europe/eu-missions-horizon-europe/climate-neutral-](https://ec.europa.eu/info/research-and-innovation/funding/funding-opportunities/funding-programmes-and-open-calls/horizon-europe/eu-missions-horizon-europe/climate-neutral-and-smart-cities_en)  
441 [and-smart-cities\\_en](https://ec.europa.eu/info/research-and-innovation/funding/funding-opportunities/funding-programmes-and-open-calls/horizon-europe/eu-missions-horizon-europe/climate-neutral-and-smart-cities_en). [Accessed: 05-Mar-2022].
- 442 [2] EUROPEAN COMMISSION, "A European strategic long-term vision for a prosperous, modern,  
443 competitive and climate neutral economy," 2018. [Online]. Available: [https://eur-](https://eur-lex.europa.eu/legal-content/EN/TXT/HTML/?uri=CELEX:52018DC0773&from=EN)  
444 [lex.europa.eu/legal-content/EN/TXT/HTML/?uri=CELEX:52018DC0773&from=EN](https://eur-lex.europa.eu/legal-content/EN/TXT/HTML/?uri=CELEX:52018DC0773&from=EN). [Accessed:  
445 07-Oct-2019].
- 446 [3] European Commission, "The Energy Performance of Buildings Directive Factsheet," 2019.
- 447 [4] United Nations, "2018 Revision of World Urbanization Prospects," 2018.
- 448 [5] D. Connolly, "Heat Roadmap Europe: Quantitative comparison between the electricity, heating,  
449 and cooling sectors for different European countries," *Energy*, vol. 139, pp. 580–593, Nov. 2017.
- 450 [6] European Environment Agency, "Time series of population-weighted heating and cooling  
451 degree days averaged over Europe." [Online]. Available: [https://www.eea.europa.eu/data-](https://www.eea.europa.eu/data-and-maps/daviz/trend-in-heating-and-cooling-2#tab-dashboard-01)  
452 [and-maps/daviz/trend-in-heating-and-cooling-2#tab-dashboard-01](https://www.eea.europa.eu/data-and-maps/daviz/trend-in-heating-and-cooling-2#tab-dashboard-01). [Accessed: 20-Aug-2021].
- 453 [7] J. Huang, J. Fan, and S. Furbo, "Feasibility study on solar district heating in China," *Renewable*  
454 *and Sustainable Energy Reviews*, vol. 108. Elsevier Ltd, pp. 53–64, 01-Jul-2019.
- 455 [8] M. Huculak, W. Jarczewski, and M. Dej, "Economic aspects of the use of deep geothermal heat  
456 in district heating in Poland," *Renewable and Sustainable Energy Reviews*, vol. 49. Elsevier Ltd,  
457 pp. 29–40, 10-May-2015.
- 458 [9] J. Barco-Burgos, J. C. Bruno, U. Eicker, A. L. Saldaña-Robles, and V. Alcántar-Camarena, "Review  
459 on the integration of high-temperature heat pumps in district heating and cooling networks,"  
460 *Energy*, vol. 239, p. 122378, Jan. 2022.
- 461 [10] P. Mi, J. Zhang, Y. Han, and X. Guo, "Study on energy efficiency and economic performance of  
462 district heating system of energy saving reconstruction with photovoltaic thermal heat pump,"  
463 *Energy Convers. Manag.*, vol. 247, p. 114677, Nov. 2021.
- 464 [11] L. Miró, S. Brückner, and L. F. Cabeza, "Mapping and discussing Industrial Waste Heat (IWH)  
465 potentials for different countries," *Renewable and Sustainable Energy Reviews*, vol. 51. Elsevier  
466 Ltd, pp. 847–855, 21-Jul-2015.
- 467 [12] E. Oró, P. Taddeo, and J. Salom, "Waste heat recovery from urban air cooled data centres to  
468 increase energy efficiency of district heating networks," *Sustain. Cities Soc.*, vol. 45, pp. 522–  
469 542, Feb. 2019.
- 470 [13] J. Li, Z. Yang, H. Li, S. Hu, Y. Duan, and J. Yan, "Optimal schemes and benefits of recovering waste  
471 heat from data center for district heating by CO<sub>2</sub> transcritical heat pumps," *Energy Convers.*  
472 *Manag.*, vol. 245, p. 114591, Oct. 2021.
- 473 [14] E. Fahlén, L. Trygg, and E. O. Ahlgren, "Assessment of absorption cooling as a district heating  
474 system strategy - A case study," in *Energy Conversion and Management*, 2012, vol. 60, pp. 115–  
475 124.
- 476 [15] C. Y. Hsu, T. Y. Lin, J. De Liang, C. H. Lai, and S. L. Chen, "Optimization analysis of waste heat  
477 recovery district cooling system on a remote island: Case study Green Island," *Energy Convers.*

- 478 *Manag.*, vol. 183, pp. 660–670, Mar. 2019.
- 479 [16] G. Franchini, G. Brumana, and A. Perdicizzi, “Performance prediction of a solar district cooling  
480 system in Riyadh, Saudi Arabia – A case study,” *Energy Convers. Manag.*, vol. 166, pp. 372–384,  
481 Jun. 2018.
- 482 [17] K. Thakar, R. Patel, and G. Patel, “Techno-economic analysis of district cooling system: A case  
483 study,” *J. Clean. Prod.*, vol. 313, p. 127812, Sep. 2021.
- 484 [18] Z. Shi, S. Hsieh, J. A. Fonseca, and A. Schlueter, “Street grids for efficient district cooling systems  
485 in high-density cities,” *Sustain. Cities Soc.*, vol. 60, p. 102224, Sep. 2020.
- 486 [19] Z. Shi, J. A. Fonseca, and A. Schlueter, “Floor area density and land uses for efficient district  
487 cooling systems in high-density cities,” *Sustain. Cities Soc.*, vol. 65, p. 102601, Feb. 2021.
- 488 [20] A. Alajmi and M. Zedan, “Energy, cost, and environmental analysis of individuals and district  
489 cooling systems for a new residential city,” *Sustain. Cities Soc.*, vol. 54, p. 101976, Mar. 2020.
- 490 [21] M. Abugabbara, S. Javed, and D. Johansson, “A simulation model for the design and analysis of  
491 district systems with simultaneous heating and cooling demands,” *Energy*, vol. 261, p. 125245,  
492 Dec. 2022.
- 493 [22] S. Bordignon, D. Quaggiotto, J. Vivian, G. Emmi, M. De Carli, and A. Zarrella, “A solar-assisted  
494 low-temperature district heating and cooling network coupled with a ground-source heat  
495 pump,” *Energy Convers. Manag.*, vol. 267, p. 115838, Sep. 2022.
- 496 [23] D. Romanov and B. Leiss, “Geothermal energy at different depths for district heating and  
497 cooling of existing and future building stock,” *Renew. Sustain. Energy Rev.*, vol. 167, p. 112727,  
498 Oct. 2022.
- 499 [24] Y. Zhang, P. Johansson, and A. Sasic Kalagasidis, “Assessment of district heating and cooling  
500 systems transition with respect to future changes in demand profiles and renewable energy  
501 supplies,” *Energy Convers. Manag.*, vol. 268, p. 116038, Sep. 2022.
- 502 [25] K. N. Finney, V. N. Sharifi, J. Swithenbank, A. Nolan, S. White, and S. Ogden, “Developments to  
503 an existing city-wide district energy network - Part I: Identification of potential expansions using  
504 heat mapping,” *Energy Convers. Manag.*, vol. 62, pp. 165–175, 2012.
- 505 [26] S. Nielsen and B. Möller, “GIS based analysis of future district heating potential in Denmark,”  
506 *Energy*, vol. 57, pp. 458–468, Aug. 2013.
- 507 [27] T. Novosel, T. Pukšec, N. Duić, and J. Domac, “Heat demand mapping and district heating  
508 assessment in data-poor areas,” *Renew. Sustain. Energy Rev.*, vol. 131, p. 109987, Oct. 2020.
- 509 [28] T. Novosel, M. Grozdek, J. Domac, and N. Duić, “Spatial assessment of cooling demand and  
510 district cooling potential utilizing public data,” *Sustain. Cities Soc.*, vol. 75, p. 103409, Dec. 2021.
- 511 [29] H. Golmohamadi, K. G. Larsen, P. G. Jensen, and I. R. Hasrat, “Integration of flexibility potentials  
512 of district heating systems into electricity markets: A review,” *Renew. Sustain. Energy Rev.*, vol.  
513 159, p. 112200, May 2022.
- 514 [30] F. Xu, L. Hao, L. Chen, Q. Chen, M. Wei, and Y. Min, “Discussions on the real potential of district  
515 heating networks in improving wind power accommodation with temperature feedback as one  
516 consideration,” *Energy Convers. Manag.*, vol. 250, p. 114907, Dec. 2021.
- 517 [31] H. Lund, N. Duic, P. A. Østergaard, and B. V. Mathiesen, “Future district heating systems and  
518 technologies: On the role of smart energy systems and 4th generation district heating,” *Energy*,  
519 vol. 165, pp. 614–619, Dec. 2018.
- 520 [32] H. Lund, N. Duic, P. A. Østergaard, and B. V. Mathiesen, “Smart Energy and District Heating:  
521 Special Issue dedicated to the 2016 Conference on Smart Energy Systems and 4 th Generation  
522 District heating,” in *Energy*, 2018, vol. 160, pp. 1220–1223.
- 523 [33] L. Herc, A. Pfeifer, F. Feijoo, and N. Dui, “Energy system transitions pathways with the new  
524 H2RES model: A comparison with existing planning tool,” *Electron. Energy*, vol. 1, p. 100024,  
525 2021.
- 526 [34] “Dispa-SET for the Balkans region — Documentation.” [Online]. Available:  
527 <http://www.dispaset.eu/en/latest/casebalkans.html>. [Accessed: 14-Jul-2022].
- 528 [35] “Measurement of Domestic Hot Water Consumption in Dwellings.”
- 529 [36] “EnergyPLAN | Advanced energy systems analysis computer model.” [Online]. Available:

- 530 <http://www.energyplan.eu/>. [Accessed: 24-Feb-2018].
- 531 [37] "Renewables.ninja." [Online]. Available: <https://www.renewables.ninja/>. [Accessed: 14-Jul-
- 532 2022].
- 533 [38] Danish Energy Agency, "Technology Data for Energy Plants for Electricity and District heating
- 534 generation," Copenhagen, 2016.
- 535