

Mapping of product functions and design principles for additive manufacturing

Valjak, Filip

Doctoral thesis / Disertacija

2022

Degree Grantor / Ustanova koja je dodijelila akademski / stručni stupanj: **University of Zagreb, Faculty of Mechanical Engineering and Naval Architecture / Sveučilište u Zagrebu, Fakultet strojarstva i brodogradnje**

Permanent link / Trajna poveznica: <https://urn.nsk.hr/urn:nbn:hr:235:355755>

Rights / Prava: [In copyright](#) / [Zaštićeno autorskim pravom.](#)

Download date / Datum preuzimanja: **2024-07-17**

Repository / Repozitorij:

[Repository of Faculty of Mechanical Engineering and Naval Architecture University of Zagreb](#)





University of Zagreb

Faculty of Mechanical Engineering and Naval Architecture

Filip Valjak

**MAPPING OF PRODUCT FUNCTIONS AND
DESIGN PRINCIPLES FOR ADDITIVE
MANUFACTURING**

DOCTORAL DISSERTATION

Zagreb, 2022



University of Zagreb

Faculty of Mechanical Engineering and Naval Architecture

Filip Valjak

**MAPPING OF PRODUCT FUNCTIONS AND
DESIGN PRINCIPLES FOR ADDITIVE
MANUFACTURING**

DOCTORAL DISSERTATION

Supervisor:

Professor Nenad Bojčetić, PhD.

Zagreb, 2022



Sveučilište u Zagrebu

Fakultet strojarstva i brodogradnje

Filip Valjak

**POVEZIVANJE FUNKCIJA PROIZVODA
I PRINCIPA KONSTRUKCIJSKOGA
OBLIKOVANJA PO KRITERIJU
PRIHVATLJIVOSTI ZA
ADITIVNU PROIZVODNJU**

DOKTORSKI RAD

Mentor:

Prof. dr. sc. Nenad Bojčetić

Zagreb, 2022.

BIBLIOGRAPHY DATA

UDC:	005.933.1:658.5
Keywords:	design for additive manufacturing, early design phases, function structure, function integration, design principle, mapping process, case study research
Scientific area:	Technical Sciences
Scientific filed:	Mechanical Engineering
Institution:	University of Zagreb, Faculty of Mechanical Engineering and Naval Architecture
Supervisor:	Prof. Nenad Bojčetić, PhD.
Number of pages:	191
Number of figures:	57
Number of tables:	24
Number of references:	200
Date of oral examination:	08. 07. 2022
Committee members:	Prof. Mario Štorga, PhD University of Zagreb, Faculty of Mechanical Engineering and Naval Architecture, Croatia Prof. Damir Godec, PhD University of Zagreb, Faculty of Mechanical Engineering and Naval Architecture, Croatia Prof. Željko Ivandić, PhD University of Slavonski Brod, Mechanical Engineering Faculty, Croatia
Archive:	University of Zagreb National and University Library in Zagreb Faculty of Mechanical Engineering and Naval Architecture, University of Zagreb

ACKNOWLEDGEMENTS

I would like to extend my gratitude to my supervisor Prof. Nenad Bojčetić, for his guidance, encouragement and help throughout this research project. My sincere gratitude goes to the examiners, Prof. Mario Štorga, Prof. Damir Godec, and Prof. Željko Ivandić, for reviewing the thesis and providing insightful remarks.

Thanks to my colleagues from CADLab and everyone with whom I had the pleasure to work during this journey.

Many thanks to Mateja, Fanika and especially Regina for their time, effort, and patience in creating a bunch of function structures that enabled me to test some early ideas. Special thanks to Marija, Petra, Ivona, Ana, and Tomislav for their willingness to participate in case studies. Your help and effort significantly supported the completion of my thesis. Thank you!

Tomislav, thank you for your support, bits of advice and help over the years, as well as encouragement to become a mechanical engineer in the first place!

Marija, thank you for lugging me to take a break from research from time to time!

Dora, thank you for your continuous support and encouragement, for proofreading my papers, for all the phone calls and coffee breaks, for calming me down and for giving me advice when I needed one. You were always there with a word of encouragement or a listening ear. Thank you!

Finally, the biggest thanks and gratitude to my parents, Ana & Darko, and brother Luka for the support, encouragement, and love. Without you, this thesis would not be possible! Hvala Luka! Hvala mama i tata!

Filip Voljak

This page intentionally left blank.

CONTENTS

Contents.....	i
About the Supervisor.....	v
Abstract.....	vi
Prošireni sažetak.....	vii
List of Figures.....	xii
List of Tables.....	xiv
List of Abbreviations.....	xv
1 Introduction.....	1
1.1 Motivation.....	1
1.2 Research Focus.....	6
1.2.1 Research Objective.....	8
1.2.2 Research Hypothesis.....	8
1.3 Overall Research Methodology.....	8
1.4 Scientific Contribution.....	10
1.5 Thesis Structure.....	10
2 Literature Background.....	15
2.1 Additive Manufacturing.....	15
2.1.1 Principle & general process of AM.....	16
2.1.2 AM processes and materials.....	19
2.1.3 Characteristics of AM.....	20
2.2 Design for Additive Manufacturing.....	23
2.2.1 DfAM Categorisation.....	24
2.2.2 DfAM Methodologies.....	26
2.2.3 DfAM Methods.....	27
2.2.4 DfAM Guidelines.....	29
2.2.5 DfAM Tools.....	30
2.3 Function Modelling.....	32
2.3.1 Function & Function Models.....	33
2.3.2 Function structure.....	37
2.3.3 Critique of function models.....	39
2.3.4 Vocabularies for function modelling.....	39
2.3.5 Rules for creating function structures.....	42
2.4 Function Integration & Function Mapping.....	44
2.4.1 Function Integration.....	45
2.4.2 Function mapping for design synthesis.....	46
2.4.3 Function mapping for design evaluation.....	48
2.5 Research Gap.....	49
2.5.1 RQ1.....	49
2.5.2 RQ2.....	50
2.5.3 RQ3.....	51
2.5.4 RQ4.....	52
3 Analysis of AM Products & Parts.....	53
3.1 Empirical Study Outline.....	53
3.2 Data Gathering.....	55
3.3 Study of AM Products & Parts Functions.....	58

3.3.1	Initial Function Modelling.....	58
3.3.2	Consolidation of Function Structures	61
3.3.3	Results	64
3.4	Study of AM Forms	64
3.4.1	AM Form Analysis	65
3.4.2	Results	67
3.5	Study of AM Form-to-Function Relations.....	67
3.5.1	Form-To-Function Analysis	68
3.5.2	Results	70
3.6	Convergence of Results	70
4	Mapping Methodology	71
4.1	Mapping Methodology.....	71
4.2	Function Class Method	77
4.2.1	Graphical Representation	79
4.2.2	Vocabulary.....	80
4.2.3	Function Classes	82
4.2.4	Modelling Rules	86
4.3	Mapping Method.....	87
4.3.1	Mapping Rules.....	88
4.3.2	Design Principles for AM.....	91
5	Computational Prototype Framework	93
5.1	FM App Architecture	93
5.2	FM App Modes of Operation.....	99
5.2.1	Function Modelling	100
5.2.2	Function Mapping.....	101
6	Case Study Design	103
6.1	Overview of case study research.....	103
6.2	Rationale for using validation case studies	105
6.3	Design of Case Study	106
6.3.1	Case study questions.....	106
6.3.2	Case study propositions	107
6.3.3	Units of analysis	107
6.3.4	Selection of Cases.....	107
6.4	Case Study Preparation	109
6.4.1	Data collection procedure	109
6.4.2	Logic linking data to propositions	113
6.4.3	Selected Case Studies	115
7	Case Study Results	119
7.1	Case Study 1: AM Gear	119
7.1.1	Case study context.....	119
7.1.2	Case study report & analysis	122
7.1.3	Conclusion & Pattern Matching	125
7.2	Case Study 2: AM Bicycle.....	127
7.2.1	Case study context.....	127
7.2.2	Case study report & analysis	130
7.2.3	Conclusion & Pattern Matching	133
7.3	Case Study 3: Toy Car	135
7.3.1	Case study context.....	135
7.3.2	Case study report & analysis	137

7.3.3	Conclusion & Pattern Matching	139
7.4	Case Study 4: Heat exchanger	141
7.4.1	Case study context	141
7.4.2	Case study report & analysis	144
7.4.3	Conclusion & Pattern Matching	145
7.5	Cross case study analysis	147
8	Discussion	149
8.1	Function modelling of AM products.....	149
8.2	Design Principles for AM	153
8.3	Function to form relations in AM products	155
8.4	Function integration and embodiment of AM design solutions.....	157
8.5	Characteristics of the Mapping Methodology.....	159
8.6	Validity of the Mapping Methodology	161
9	Conclusion.....	165
9.1	Research Outline	165
9.2	Hypothesis & Contribution	167
9.3	Research Limitations	168
9.4	Future Work	169
	References	170
	Biography	188
	Životopis.....	189
	Bibliography	190
Appendix A	Illustrative Example	A-1
A.1	Function Modelling.....	A-1
A.2	Mapping Process	A-4
A.3	Concept Generation	A-7
Appendix B	FC Method	B-1
B.1	Primary Rules.....	B-1
B.2	Function Classes	B-3
B.3	Modelling Rules.....	B-11
Appendix C	AM Design Principles.....	C-1
Appendix D	Mapping Rules	D-1
D.1	Function blocks mapping rules	D-1
D.2	Flow Mapping Rules.....	D-6
D.3	Individual Function Mapping Rules	D-7
Appendix E	Case Study 1: AM Gear	E-1
E.1	Project documents	E-1
E.2	Observation Notes.....	E-9
E.3	Interview Transcript.....	E-11
Appendix F	Case Study 2: AM Bicycle.....	F-1
F.1	Project documents	F-1
F.2	Observation Notes.....	F-13
F.3	Interview Transcript.....	F-16
Appendix G	Case study 3: Toy Car	G-1
G.1	Project documents	G-1
G.2	Observation notes.....	G-11

G.3	Interview transcript 1	G-14
G.4	Interview transcript 2	G-16
Appendix H	Case Study 4: Heat Exchanger.....	H-1
H.1	Project documents.....	H-1
H.2	Observation notes.....	H-6
H.3	Interview Transcript.....	H-7

ABOUT THE SUPERVISOR

Nenad Bojčetić was born in Sisak, Croatia, in 1965. He enrolled in the study of Mechanical Engineering at the Faculty of Mechanical Engineering and Naval Architecture University of Zagreb (UNIZAG-FSB) in 1985 and in 1991 he graduated as Master of Mechanical Engineering at the same institution with specialization in the Engineering Design. After graduation he applied for the position at the Chair of Design and Product Development at UNIZAG-FSB as a young researcher he also started his PhD study. In 1996 he received M.Sc. in Mechanical Engineering, Chair for Design and Product Development, Faculty of Mechanical Engineering and Naval Architecture, University of Zagreb, 1996, Advisor: Prof. Dorian Marjanović and in 2001 Ph.D. in Mechanical Engineering at the same faculty.

He participated in a number of research projects and was project member on three research projects funded by Ministry of Science and Technology of Republic of Croatia: “Models of Intelligent Computer Aided Design System” (1996-2001); “Models and Methods of Advanced Computer Support to Product Development” (2002-2006) and “Models and Methods of Knowledge Management in Product Development” (since 2007). He was also a project member on EUREKA founded project "E!4911 TRaceability of ENgineering INformation – TRENIN", (2009-2011). He also participated or led couple of industrial projects on PLM implementation and customization (Cimos ltd., Koncar - Power Transformers ltd. and Koncar - Medium Voltage Apparatus Inc.) and on CAD customization (Dalekovod ltd., Gorenje ltd., Koncar - Generators and Motors Inc., IHS ltd., MotoMAN ltd., Elan ltd.)

The primary field of research and scientific focus of Mr Bojčetić in last 25 years has been multidisciplinary field of the CAD, CAE applications, knowledge management and technical information systems in engineering design. Mr Bojčetić is a member of HDESK (Croatian Society for machine elements and design) and international organisation The Design Society. He has actively participated in the organisation of the biennial DESIGN series event since 1998 that regularly attracts more than 250 experts from more than 30 countries around the world.

Besides the scientific and professional work, Mr Bojčetić is involved in teaching through UNIZAG-FSB undergraduate and graduate study programs in knowledge management, technical information systems and CAD. As a part-time assistant lecturer, he held tutorials at the Polytechnics of Zagreb and Study of Design at the Faculty of Architecture. He was also involved in tutorials on advanced usage of various CAD and PLM applications.¹

¹ <https://www.cadlab.fsb.hr/en/chair/staff/nenad-bojctetic-3>

ABSTRACT

Additive Manufacturing (AM) brought new manufacturing capabilities, new and unique design possibilities, and unprecedented design freedom. However, due to the uniqueness of AM, the designers working with AM have trouble designing products that will utilise those benefits. The issue is noticeable when the AM knowledge needs to be applied from the early phases of the design process to influence product functionality and preliminary layout. The research presented in this thesis aims to develop the Mapping Methodology for choosing AM Design Principles (DPs) used for creating a design solution for one or more functions of a product. The methodology aims to help engineers to apply DfAM (Design for Additive Manufacturing) in the early stages of the design process to utilise and implement the unique possibilities of AM. To develop such a methodology, the research is focused on investigating and understanding function modelling of AM products, sources of AM knowledge for early design phases and formalisation of function-to-form relation to be used in new AM product development.

The presented research follows the Design Research Methodology. It firstly provides research clarification, followed by a review of relevant literature on DfAM and function modelling. Then an empirical study based on the analysis of the pool of AM products is conducted to improve the understanding of the observed phenomena. Furthermore, based on the theoretical background from the literature review and the results of the empirical study, the Mapping Methodology is presented. The developed Mapping Methodology provides the design support for the early design phases of AM oriented design process by integrating the conceptual and early embodiment design. Through the function modelling and mapping process, the methodology supports function integration and mapping of product functions and AM DPs. Furthermore, it enables the development of concepts that, through the preliminary layout of the form, embody AM based solutions.

The results of the research are validated using the case study research method. The validation showed the Mapping Methodology's benefits in the early design phases. Through four case studies, both novice and expert designers successfully used the methodology to develop various concepts of AM products and achieved function integration and embodiment of AM design solutions. The evidence gathered through the validation process supports the research hypothesis that mapping of function model of a product and AM DPs enable function integration and embodiment of design solutions adapted for AM.

Keywords: design for additive manufacturing, early design phases, function structure, function integration, design principle, mapping process, case study research

PROŠIRENI SAŽETAK

Aditivna proizvodnja je relativno novi proizvodni postupak, koji je principom proizvodnje gdje se materijal dodaje samo tamo gdje je potrebno kako bi se izradio neki objekt ili proizvod, donio nove jedinstvene mogućnosti i slobodu konstrukcijskog oblikovanja. Jedinstvene mogućnosti aditivne proizvodnje očituju se kroz kompleksnost oblika (moguće je izraditi praktično bilo koji geometrijski oblik), kompleksnost materijala (materijal, svojstva materijala ili boja može se promijeniti u bilo kojoj točki proizvoda), hijerarhijsku kompleksnost (značajke proizvoda mogu biti konstruirane na različitim razinama veličine) i funkcijsku kompleksnost (funkcionalne naprave mogu biti proizvedene u jednom procesu). Svojim mogućnostima aditivna proizvodnja je promijenila način izrade proizvoda, ali i vrste proizvoda koji se izrađuju, te time zahtijeva promjenu načina konstruiranja proizvoda. Kao posljedica tih promjena razvijaju se različite metode i alati konstruiranja po kriteriju prihvatljivosti za aditivnu proizvodnju kao pomoć konstruktorima za implementaciju novih mogućnosti koje aditivna proizvodnja nudi u proizvode koje konstruiraju. Iako postojeće metode konstruiranja po kriteriju prihvatljivosti za aditivnu proizvodnju pokrivaju velik dio procesa konstruiranja, još uvijek imaju mnogobrojne probleme poput nedostatka integracije u zajedničku strukturu procesa konstruiranja, nezavisnost od prijašnjih konstrukcijskih metoda, i ograničenost u jedinstvenom pristupu procesu konstruiranja. One također imaju sklonost usmjeravanja na samo neke potencijale aditivne proizvodnje, kao i usmjerenost na optimizaciju postojećih proizvoda, a ne na stvaranje novih. Dodatni problem postojećih metoda je nedostatak istraživanja utjecaja aditivne proizvodnje na rane faze razvoja proizvoda. Kako bi se premostili navedeni problemi i implementiralo znanje o aditivnoj proizvodnji i njenim mogućnostima u ranim fazama razvoja proizvoda, ovim istraživanjem predložena je nova metodologija mapiranja funkcija proizvoda i konstrukcijskih principa po kriteriju prihvatljivosti za aditivnu proizvodnju.

Cilj ovog istraživanja je razvoj metoda i alata za odabir konstrukcijskih principa namijenjenih aditivnoj proizvodnji kojima se oblikuje rješenje jedne ili više funkcija nekog proizvoda. Svrha metoda i alata je pomoć inženjerima u ranim fazama konstrukcijskog procesa za aditivnu proizvodnju kako bi iskoristili i primijenili jedinstvene mogućnosti aditivnih tehnologija tijekom konstruiranja i razvoja proizvoda. Ovim istraživanjem verificira se hipoteza da povezivanje funkcijske dekompozicije proizvoda i konstrukcijskih principa oblikovanja po kriteriju prihvatljivosti za aditivnu proizvodnju tijekom ranih faza konstrukcijskog procesa

omogućuje integraciju funkcija i oblikovanje konstrukcijskih rješenja prilagođenih aditivnoj proizvodnji.

Kako bi se razvile željene metode i alati u ovom istraživanju korištena je opća metodologija istraživanja u znanosti o konstruiranju (eng. *Design Research Methodology*). Metodologija se temelji na četiri osnovna koraka: (i) raščišćavanje zahtjeva na istraživanje, (ii) deskriptivno istraživanje I, (iii) preskriptivno istraživanje i (iv) deskriptivno istraživanje II. Raščišćavanje zahtjeva na istraživanje je prvi korak istraživanja u kojem je identificiran i formuliran istraživački problem te definiran plan istraživanja. Ovaj korak je omogućio inicijalno razumijevanje trenutnog stanja u području istraživanja te je pomogao u identifikaciji istraživačkog problema, formulaciji istraživačkih pitanja i definiranju okvira za provođenje istraživanja. Deskriptivno istraživanje I omogućilo je dubinsko razumijevanje područja istraživanja kroz pregled literature i empirijsko istraživanje. Ovaj korak je pomogao u razumijevanju glavnih čimbenika koji utječu na promatrani fenomen konstruiranja po kriteriju prihvatljivost za aditivnu proizvodnju u ranim fazama razvoja proizvoda. U preskriptivnom istraživanju razvijena je metodologija mapiranja na temelju spoznaja iz prva dva koraka. Zadnji korak istraživanja, deskriptivno istraživanje II, je bio usmjeren na empirijsku evaluaciju razvijene metodologije pomoću kvalitativnih istraživačkih metoda.

Doktorski rad strukturiran je tako da prati opisanu metodologiju istraživanja. Rad je podijeljen u devet poglavlja, te ima osam dodataka. Prvo poglavlje i dio drugog poglavlja odgovaraju koraku raščišćavanja zahtjeva na istraživanje. Dio drugog poglavlja i treće poglavlje prikazuju deskriptivno istraživanje I. Četvrto i peto poglavlje opisuju preskriptivno istraživanje, dok preostala poglavlja (šesto, sedmo, osmo i deveto) opisuju provedeno deskriptivno istraživanje II.

Prvo poglavlje („*Introduction*“) je uvodno poglavlje rada koji prikazuje motivaciju za provođenje istraživanja kroz opis potrebe za istraživanjem ranih faza razvoja proizvoda u kontekstu upotrebe aditivne proizvodnje i njenih mogućnosti konstrukcijskog oblikovanja. U motivaciji je naglašena potreba za korištenjem funkcijskog modeliranja prilikom konstruiranja za aditivnu proizvodnju i korištenje prikladnih izvora konstrukcijskog znanja kako bi se omogućila funkcijska integracija i oblikovanje konstrukcijskih rješenja prilagođenih aditivnoj proizvodnji. Ovo poglavlje opisuje ciljeve istraživanja, hipotezu istraživanja, korištenu opću metodologiju istraživanja u znanosti o konstruiranju i očekivani znanstveni doprinos disertacije. Poglavlje završava pregledom ostalih poglavlja doktorskog rada.

Drugo poglavlje („*Literature Background*“) daje pregled relevantne literature o temi istraživanja za područje konstruiranja po kriteriju prihvatljivosti za aditivnu proizvodnju i

područje funkcijskog modeliranja kroz četiri pod poglavlja. Prvi dio pregleda literature opisuje tehnologiju aditivne proizvodnje i jedinstvene mogućnosti koje ona pruža u oblikovanju i konstruiranju proizvoda. Drugi dio daje pregled trenutnih postignuća u području istraživanja konstruiranja po kriteriju prihvatljivosti za aditivnu proizvodnju s naglaskom na rane faze procesa razvoja proizvoda. Ovaj dio daje pregled postojećih metodologija, metoda i alata, te izvora znanja o konstruiranju za aditivnu proizvodnju. Treći dio pregleda literature daje pregled dosadašnjih postignuća u funkcijskom modeliranju proizvoda. Naglasak pregleda je na rječnicima za izražavanja funkcija i tokova u funkcijskoj dekompoziciji proizvoda i pravilima za modeliranje funkcijskih dekompozicija. Četvrti dio daje opis postojećih metoda mapiranja funkcija za sintezu i evaluaciju konstrukcija. Poglavlje dva završava opisom identificiranih nedostataka u području istraživanja i formulacijom četiri istraživačka pitanja.

- Koje su značajke funkcijskih modela aditivnih proizvoda i kako se trebaju izraziti funkcijske strukture proizvoda izrađenih aditivnom proizvodnjom?
- Koji su konstrukcijski principi temeljeni na mogućnostima aditivne proizvodnje?
- Koji su odnosi između konstrukcijskih principa i funkcija proizvoda u postojećim proizvodima izrađenima aditivnom proizvodnjom te kako se mogu formalizirati?
- Kako se pravila mapiranja mogu primijeniti za omogućavanje integracije funkcija i oblikovanje konstrukcijskih rješenja?

Treće poglavlje („*Analysis of AM Products & Parts*“) opisuje provedeno empirijsko istraživanje. Poglavlje započinje argumentacijom empirijskog istraživanja i postavlja okvir za njegovo provođenje kroz indukcijski pristup korištenjem tri različite analize postojećih proizvoda izrađenih aditivnom proizvodnjom. Drugi dio poglavlja opisuje protokol i kriterije za prikupljanje proizvoda koji su analizirani u ovom istraživanju. Ukupno je prikupljeno i analizirano četrdeset i pet proizvoda izrađenih aditivnom proizvodnjom. Prva provedena analiza je funkcijska analiza koja je omogućila razumijevanje značajki funkcijskih dekompozicija aditivno proizvedenih proizvoda. Druga analiza je omogućila izdvajanje konstrukcijskog znanja o aditivnoj proizvodnji potrebnog u ranim fazama razvoja proizvoda, kasnije formaliziranoga o obliku konstrukcijskih principa po kriteriju prihvatljivosti za aditivnu proizvodnju. Zadnja provedena analiza proučavala je veze između funkcija proizvoda te oblika i značajki proizvoda koji su temeljeni na mogućnostima konstrukcijskog oblikovanja za aditivnu proizvodnju. Formalizacija proučavanih veza omogućila je razvoj pravila mapiranja funkcija proizvoda i konstrukcijskih principa.

Četvrto poglavlje („*Mapping Methodology*“) predstavlja predloženu metodologiju za mapiranje funkcija proizvoda i konstrukcijskih principa po kriteriju prihvatljivosti za aditivnu proizvodnju. Predložena metodologija je razvijena na teorijskoj osnovi predstavljanoj u drugom poglavlju i rezultatima empirijskog istraživanja iz trećeg poglavlja. U ovom poglavlju prvo je predstavljen cjelokupni okvir predložene metodologije koja se sastoji od dvije razvijene metode za podršku funkcijskom modeliranju i procesu mapiranja. Metodologija je postavljena u općenite preskriptivne procese konstruiranja, kao i u specijalizirani proces konstruiranja za aditivnu proizvodnju. Time je pokazana mogućnost integracije predložene metodologije u postojeće konstrukcijske procese i povezivanje s drugim postojećim metodama i alatima za razvoj proizvoda. Opis korištenje metodologije mapiranja prikazan je u dodatku Appendix A. U drugom dijelu poglavlja predstavljena je razvijena metoda za funkcijsko modeliranje proizvoda („*Function Class Method*“) temeljena na unaprijed definiranim predlošcima funkcijskih blokova. Metoda je podržana definiranim i kategoriziranim pravilima funkcijskog modeliranja i predlošcima funkcijskih blokova koji su prikazani u dodatku Appendix B. U trećem dijelu poglavlja predstavljena je metoda za mapiranje („*Mapping Method*“). Metoda se temelji na razvijenim pravilima mapiranja (dani u dodatku Appendix D) i razvijenim konstrukcijskim principima po kriteriju prihvatljivosti za aditivnu proizvodnju (dani u dodatku Appendix C).

Peto poglavlje („*Computational Prototype Framework*“) opisuje računalni prototip okoline za podršku povezivanju funkcijske dekompozicije proizvoda i konstrukcijskih principa oblikovanja po kriteriju prihvatljivosti za aditivnu proizvodnju („*Function Mapping Application*“). Računalni prototip razvijen je kao programski dodatak za MS Visio programsku aplikaciju i pisan je u programskom jeziku *Visual Basic for Application*.

Šesto poglavlje („*Case Study Design*“) je prvo od dva poglavlja koje opisuje evaluaciju razvijene metodologije mapiranja korištenjem metode studije slučaja. U ovom poglavlju prvo su predstavljene teoretska pozadina metode studije slučaja i argumentacija za korištenje ove metode za evaluaciju metodologije mapiranja. Poglavlje potom opisuje izradu protokola i pripreme studije slučaja te daje opis odabira slučajeva koji su proučavani.

Sedmo poglavlje („*Case Study Results*“) predstavlja drugi dio opisa studije slučaja. U ovom poglavlju opisana i analizirana su četiri različita slučaja. Svaki slučaj je opisan u pojedinačnom izvješću te analiziran tehnikom podudaranja obrazaca. Sedmo poglavlje završava usporednim izvještajem studije slučaja kojim su predstavljen opći zaključci povedene evaluacije opisanom metodom. Svaka od studija slučaja potkrijepljena je dokumentima koji su prikazani u dodacima Appendix E, Appendix F, Appendix G i Appendix H. Rezultati studije slučaja prikazuju uspješno korištenje razvijene metodologije u različitim kontekstima upotrebe, za razvoj

pojedinačnih komponenata i sklopova, za razvoj novih proizvoda i redizajn postojećih, kad metodologiju koriste iskusni i neiskusni konstruktori. Rezultati studije slučaja pokazuju da je metodologija omogućila funkcijsku integraciju i oblikovanje konstrukcijskih rješenja prilagođenih aditivnoj proizvodnji te time podupiru postavljenu hipotezu istraživanja.

Osmo poglavlje („*Discussion*“) daje osvrt na provedeno istraživanje. U ovom poglavlju najprije se raspravlja o četiri istraživačka pitanja postavljena na kraju drugog poglavlja. Za prvo istraživačko pitanje pokazano je kako su značajke funkcijskih modela proizvoda izrađenih aditivnom proizvodnjom velik broj tokova mehaničke energije i materijala, te funkcija za prihvata, provođenje i prijenos mehaničke energije. Zbog tih značajki predložena je izrada funkcijskih modela pomoću predložaka funkcijskih blokova kako bi se postigao ujednačeni prikaz funkcijskog modela potrebnog za provođenje procesa mapiranja. Drugo istraživačko pitanje je odgovoreno kroz razvoj trideset i dva konstrukcijska principa po kriteriju prihvatljivosti za aditivnu proizvodnju. Treće istraživačko pitanje identificiralo je veze između funkcija proizvoda i konstrukcijskih principa koje su formalizirane kroz razvoj četrdeset i dva pravila mapiranja. Posljednje istraživačko pitanje je odgovoreno kroz razvoj metodologije mapiranja koja omogućava integraciju funkcija i oblikovanje konstrukcijskih rješenja prilagođenih aditivnoj proizvodnji. Ovo poglavlje završava osvrtom na karakteristike razvijene metodologije i valjanost provedenog istraživanja i rezultata istraživanja pokazujući logičku dosljednost koraka istraživanja.

Deveto poglavlje („*Conclusion*“) je zaključno poglavlje ovog doktorskog rada. Poglavlje sažima provedeno istraživanje i daje osvrt na hipotezu istraživanja i znanstveni doprinos rada. Nakon toga dan je osvrt na ograničenja istraživanja i prijedlog mogućih smjerova budućih istraživanja. Izvorni znanstveni doprinosi ovog doktorskog rada očituju se kroz:

1. Metodologiju za rane faze procesa razvoja proizvoda koja omogućuje povezivanje funkcija proizvoda ili niza funkcija s konstrukcijskim principima oblikovanja po kriteriju prihvatljivosti za aditivnu proizvodnju.
2. Računalni prototip okoline za podršku povezivanju funkcijske dekompozicije proizvoda i konstrukcijskih principa oblikovanja po kriteriju prihvatljivosti za aditivnu proizvodnju temeljem predložene metode sa svrhom integracije funkcija i oblikovanja konstrukcijskih rješenja.

Ključne riječi: konstruiranje po kriterijima prihvatljivosti za aditivnu proizvodnju, rane faze konstrukcijskog procesa, funkcijska struktura, funkcijska integracija, konstrukcijski princip, proces mapiranja, studija slučaja

LIST OF FIGURES

Figure 1.1	Examples of AM enabled features.....	2
Figure 1.2	Current application of DfAM and proposed application of DfAM.....	6
Figure 1.3	Overview of thesis structure.....	13
Figure 2.1	Subtractive manufacturing compared to additive manufacturing.....	16
Figure 2.2	Principle of AM through two basic techniques.....	17
Figure 2.3	Generic AM process workflow.....	18
Figure 2.4	Examples of four AM complexities.....	22
Figure 2.5	DfAM design support overview.....	25
Figure 2.6	Four function models of a screwdriver.....	36
Figure 2.7	Process of creating Function Structure.....	38
Figure 3.1	Overview of Empirical Research.....	55
Figure 3.2	Data Gathering Protocol.....	56
Figure 3.3	Overview of the pool of AM products & parts.....	57
Figure 3.4	Steps of evaluating function modelling approaches in the context of DfAM.....	58
Figure 3.5	Example: Initial function structures of an AM Gear.....	60
Figure 3.6	Protocol for functional analysis.....	62
Figure 3.7	Three morphologies of function Transfer Energy.....	63
Figure 3.8	Protocol for AM form analysis (based on [47,155]).....	65
Figure 3.9	Example: Analysis of AM milireactor.....	67
Figure 3.10	Protocol for form-to-function analysis.....	68
Figure 3.11	Example: Form-to-Function analysis of space pointing mechanism.....	69
Figure 3.12	Convergence of derived FCs, DPs, and MRs.....	70
Figure 4.1	Mapping Methodology Framework.....	73
Figure 4.2	Position of Mapping Methodology inside the systematic design processes [18,28].....	75
Figure 4.3	Position of Mapping Methodology inside the DfAM Framework by Kumke et al. [77].....	76
Figure 4.4	Function Class Method's Framework.....	78
Figure 4.5	Elements of graphical representation [18,116,129].....	79
Figure 4.6	Representation of flows entering and exiting function block [134].....	80
Figure 4.7	Representation of flows in carrier-carried relation [132].....	80
Figure 4.8	Mapping Method's framework.....	88

Figure 5.1	FM App Architecture.....	94
Figure 5.2	MS Visio with loaded FM App Stencil (FM_App.vsmm).....	94
Figure 5.3	Stencil Objects.....	95
Figure 5.4	Start User Form.....	96
Figure 5.5	Function Block Form.....	96
Figure 5.6	Mapping form.....	97
Figure 5.7	Double Rule form.....	97
Figure 5.8	Connect Flows Form.....	98
Figure 5.9	Excel Workbook Example.....	98
Figure 5.10	Example of Function Block record in an XML File.....	99
Figure 5.11	FM App Initialisation process.....	99
Figure 5.12	Workflow for creating Function Block using FM App.....	100
Figure 5.13	Function Block Creator VBA User Form.....	101
Figure 5.14	Workflow for creating mapping process using FM App.....	102
Figure 5.15	Mapping process VBA User Form.....	102
Figure 6.1	Phases of the Case Study research [172].....	104
Figure 6.2	Data Collection Protocol.....	110
Figure 6.3	Overview of selected cases.....	117
Figure 6.4	Case Study Report Format.....	117
Figure 7.1	Overview of Case Study 1: AM Gear [186].....	121
Figure 7.2	Overview of Case Study 2: AM Bicycle [188].....	129
Figure 7.3	Overview of Case Study 3: Toy Car [189].....	136
Figure 7.4	Overview of Case Study 4: Heat Exchanger [190].....	143
Figure 8.1	Occurrence of flows in the performed analysis.....	150
Figure 8.2	Occurrence of functions in the performed analysis.....	151
Figure 8.3	Validation Square [199,200].....	162
Figure 8.4	Construct's information flow.....	163

LIST OF TABLES

Table 2.1	Overview of AM processes	20
Table 2.2	Selected function definitions from the literature	33
Table 2.3	Three function modelling vocabularies (function terms only)	41
Table 4.1	Vocabulary of function and flows	81
Table 4.2	Example of Function Class definition for function Separate Material	84
Table 4.3	Function Classes for function Transfer	85
Table 4.4	Example of function blocks MRs	89
Table 4.5	Example of flow MRs.....	90
Table 4.6	Examples of individual function MRs.....	90
Table 4.7	Example of DPs	92
Table 6.1	Interview guide	112
Table 6.2	Data systemisation template	113
Table 6.3	Case Study Patterns	115
Table 6.4	Cases used for Mapping Methodology validation	116
Table 7.1	List of data sources for Case Study 1, AM Gear	122
Table 7.2	Pattern Matching for Case Study 1	126
Table 7.3	List of data sources for Case Study 2: AM Bicycle	130
Table 7.4	Pattern Matching for Case Study 2.....	134
Table 7.5	List of data sources for Case Study 3: Toy Car	137
Table 7.6	Pattern Matching for Case Study 3	140
Table 7.7	List of data sources for Case Study 4: Heat Exchanger	142
Table 7.8	Pattern Matching for Case Study 4.....	146
Table 7.9	Patterns from all case studies.....	147
Table 8.1	Comparison with the list of Important Characteristics of Early Phase DfAM Methods [14,197]	159

LIST OF ABBREVIATIONS

3D model	3-dimensional model
3DP	3D Printing
3MF	3D Manufacturing Format
AM	Additive Manufacturing
AMF	Additive Manufacturing File
AMIO	Additive Manufacturing of Intermediate Objects
AMK	AM Design Knowledge
ASTM	American Society for Testing and Materials
CAD	Computer-Aided Design
CLI	Common Layer Interface
CNC	Computer Numerical Control
CS	Case Study
DfA	Design for Assembly
DfAM	Design for Additive Manufacturing
DfM	Design for Manufacturing
DfX	Design for Excellence
DIwAM	Design Innovation with Additive Manufacturing
DLP	Digital Light Processing
DMLS	Direct Metal Laser Sintering
DP	Design Principle(s)
DRM	Design Research Methodology
DS-I	Descriptive Study I
DS-II	Descriptive Study II

EBM	Electron Beam Melting
EBW	Electronic Beam Welding
EF-M	Enhanced Function-Means modelling
FC	Function Class
FC Method	Function Class Method
FDM	Fused Deposition Modelling
FGM	Functionally Graded Materials
GUI	Graphical User Interface
IDE	Integrated Development Environment
ISO	International Organization for Standardization
LENS	Laser Engineered Net Shaping
LiDS	Lifecycle Design Strategies
LLM	Layer Laminate Manufacturing
LOM	Laminated Object Manufacturing
MFP Structure	Mapped-Function-Principle Structure
MMAM	Multiple Material Additive Manufacturing
MR	Mapping Rule
PR	Proposition
PRFS	Procedural Rule-based Functional Modeling Structure
PS	Prescriptive Study
RC	Research Clarification
RQ	Research Question(s)
SLA	Stereolithography
SLM	Selective Laser Melting

SLS	Selective Laser Sintering
STL	Standard Tessellation Language
SWOT	Strengths, Weaknesses, Opportunities and Threats
TO	Topological Optimisation
TRIZ	Theory of Inventive Problem Solving
UV	Ultraviolet
VBA	Visual Basic for Application
XML	Extensible Markup Language

This page intentionally left blank.

1

Introduction

Chapter 1 is an introductory chapter of the thesis. It firstly describes the motivation of the research and places the research in the context of the design process. Secondly, the chapter outlines the research aims, objectives and hypotheses. This is followed by the description of the used research methodology and the expected contributions of the thesis. Finally, the chapter concludes with an overview of the thesis structure.

1.1 Motivation

Additive manufacturing (AM), also known as 3D printing, is a relatively novel manufacturing technology based on the principle of adding material only where it is needed to build a part [1]. The additive nature of the technology enables unique design and manufacturing capabilities that significantly influence the design and functionalities of products [2]. Foremost, AM enables the manufacturing of complex shapes and removes many design restrictions, such as drafts, undercuts, etc., without direct correlation with production costs. Furthermore, it permits access to the inside of the part during fabrication which enables the creation of internal structures. Additionally, point-by-point material deposition permits the use of different materials and enables Multiple Material Additive Manufacturing (MMAM), but also enables the use of Functionally Graded Materials (FGM) through manipulation of material properties across the part. AM also enables the consolidation of parts, function integration and has the capability to manufacture entire assemblies in a single build, thus reducing the need for assembly operations. At the same time, AM does not require additional tooling, which facilitates economically viable small batch production, consequently allowing individual customisation of each product to fit a particular user or use case [1,3–5]. These examples are only a fraction of AM capabilities that make the AM technology stand out from conventional manufacturing processes and is gaining rapid popularity for various applications (Figure 1.1).

The AM started its journey as a rapid prototyping technology, but with the advent of AM technologies in recent years, its technical capabilities were greatly improved, and AM transferred from laboratory and rapid prototyping settings to production shop floors as manufacturing technology for end-use products [6]. Nowadays, AM is made of a versatile set of technologies that provide reliable and repeatable manufacturing and enable unprecedented design freedom, new and unique design capabilities, as well as new business model

1. Introduction

opportunities [1,4,5]. Because of the advantages AM offers, more and more companies and designers are adopting AM [7,8], and new products with unique features, functionalities and performance improvements enabled with AM are hitting the market.

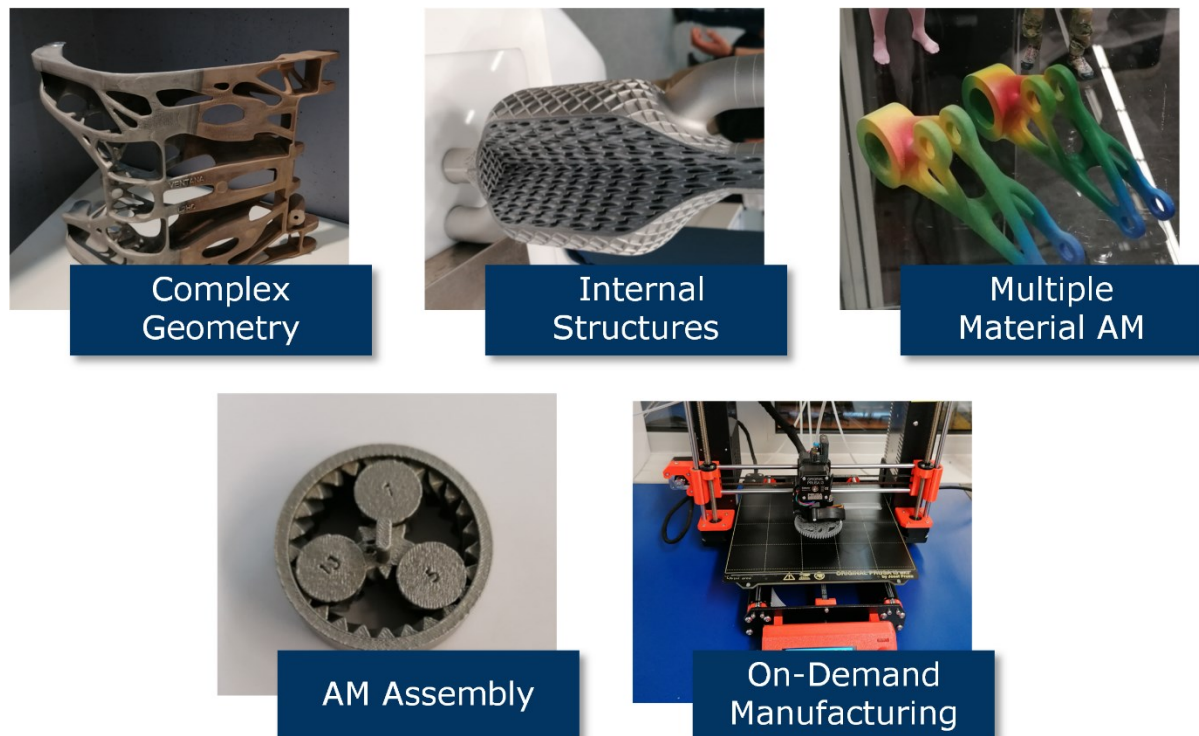

Figure 1.1 Examples of AM enabled features

And while the thrilling-looking examples of AM products and AM applications can regularly be seen in media, advertisements, and fairs, designers often do not have experience in designing such products and utilise all possibilities of AM [9]. Some of the reasons why designers struggle to design genuine AM products are the designers' unfamiliarity with the AM technology [2], lack of specialised sources of AM design knowledge (AMK), lack of design methods and tools tailored for AM oriented design process [10], but also conceptual barriers created by conventional manufacturing technologies that cause design fixation [11–13] and limit designers' creativity while designing AM products [2]. Due to the different nature of AM when compared to conventional manufacturing technologies, designers need to break from their traditional mindset imposed by the established curriculum in engineering schools and design practice that is still mainly based on subtractive and formative technologies and embrace AM possibilities [2,14]. Hence, new AMK sources and new approaches tailored for the AM oriented design process are needed.

Researchers responded to these issues by investigating the influence of AM on the design process and developed a new set of design support methods and tools tailored for this new technology to help designers utilise its potentials. As a result, a new design approach emerged

from this research - Design for Additive Manufacturing (DfAM). DfAM is a design paradigm focused on utilising AM potentials and avoiding its limitations [15,16]. In this regard, the DfAM is similar to other Design for Excellence (DfX) approaches based on a specific knowledge that attempts to maximise desirable characteristics in a product during the design process, such as manufacturability, reliability, safety, environmental friendliness, etc., while minimising the manufacturing and lifetime costs [17].

To understand the benefits and limitations of current DfAM approaches, they are observed inside Pahl & Beitz's [18] design process framework (shown later in Figure 1.2). This systematic design process starts with planning and clarification of the design problem. Followed by the conceptual design where, through abstraction, the establishment of function structures and the search for a working principle, the principle solution is specified in the form of concepts. The concepts are further developed in the embodiment design phase in two steps. Firstly, the preliminary layout and form of the product are created. This includes, among other activities, design of the form, material selection, and solving auxiliary functions regarding technical and economic criteria. Secondly, the definitive layout is created by completing and optimising the form, checking for errors, and preparing preliminary parts for production. The design process ends with the detail design, which completes the embodiment of the product.

In this context, most of the hitherto developed DfAM design support methods and tools are focused on the design phases of embodiment, detail design, and manufacturing preparation [10,19]. These design supports help in the detailed design of AM products by providing information regarding features dimensions, part orientation, support structures, manufacturing process parameters and so on, and thus have a crucial role in ensuring the manufacturability of final designs (e.g., [20–27]). Therefore, the final designs usually utilise some AM possibilities, such as topologically optimised shapes, lattice structures for lightweight design, etc. However, because DfAM is applied after the principle solution is developed, these AM features do not influence the functionality of the product and its principle layout, and only a portion of AM possibilities are utilised in the design of a product.

Therefore, to truly utilise the design possibilities enabled by AM, it is essential to think additively and apply DfAM design supports and use AMK from the early phases of the design process [14]. This importance arises from the design activities of establishing the functional and working structure of the product and defining the preliminary product layout because these design activities directly influence the function and form of the product [18,28,29]. Therefore, when DfAM and AMK are applied during the activities of early design phases (conceptual design and early embodiment), the component, subsystem or even the entire product can be

1. Introduction

designed in a way that will take advantage of AM to improve product shape, functionality, function integration and performance. Designers working with AM are aware of the importance of thinking additively from the beginning of the design process but feel the lack of DfAM design support and appropriate sources of AMK for the early design phases [9].

While today handful of DfAM design supports for early phases of AM oriented design process exist, they vary in purpose and granularity. Moreover, they are often just a source of AMK or are focused only on a particular design task or activity without a broader framework of how they relate to the rest of the design process. Therefore, a comprehensive systematic DfAM design support for early design phases that can be easily incorporated into the existing systematic design processes is needed. Firstly, many literature sources prescribe and recommend the use of systematic design approaches due to the technical and economic benefits they provide [18,28–32]. Systematic design approaches steer the design process, and among the other benefits, they increase the chance of finding appropriate solutions, promote collaboration, support management of design activities, help in automation of design activities and enable the reuse of previous design solutions. Furthermore, systematic design can aid in creativity and search for new and innovative solutions, help solve emerging issues, and act as a safeguard that no critical function, requirement, or constraint is overlooked [18,28]. It also provides support for routine design activities that enable designers to focus on more essential design tasks rather than trivial ones [31,32]. Secondly, the systematic design approaches are part of the curriculum during designers' education, so most designers are familiar with the overall layout of the design process and can quickly grasp and incorporate a new module into the design process if it is compatible with the existing framework they follow.

An important characteristic of many systematic design processes is consideration of design requirements in terms of product functions and making sure the final solution incorporates technical solutions to fulfil the product functions to meet those requirements, thus reducing the uncertainty and risk, while increasing the chance of finding the optimal solution [18]. The product function is a solution neutral description of what the product does [29]. Every design has a function it must perform to satisfy the design requirements; hence function-driven design activities are a backbone of many design processes, methods, and tools, from design generation and modification to evaluation and comparison, diagnoses, etc., [33]. When conducting a design task, either task of creating a new design or redesigning an existing one, designers usually firstly start with function modelling. Here they specify the desired functions of the product and create a function model composed of functional entities that together provide the overall function of

a product. Hence the design activities that follow and the design process itself are function-laden and function-oriented [34].

Due to its abstract and solution neutral representation, the function model is often used in early design phases as the starting point for searching partial solutions for the given design problem [28], as it enables easy comparison of different solutions from various domains. Furthermore, the use of a function model in early design phases enables the establishment of product layout, helps in creativity and breakage of cognitive barriers, and supports the conceptualisation of the product [18,28,31]. The function modelling and function model enable an overview of all product functions and support function integration. Function integration refers to the fulfilment of a sequence of functions in a component to reduce the number of parts and improve product performances [35,36]. Due to its benefits, functions and function models found their role in many prescriptive design support methods and tools in various engineering design domains. However, their role in DfAM is not thoroughly investigated, with only a handful of DfAM approaches using functions in AM oriented design process [37–42].

The use of function modelling and function models in DfAM could enable a broader search of AM based solutions, and consequently support their embodiment. Furthermore, one of the ways how AM can further influence the products' functionality and performance is through function integration. While the conventional DfX approaches often emphasise function independence and modularity due to design simplification, function integration can improve product performance as it removes the interfaces among the function modules, produces better designs, and is often a source of novelty and interesting designs [43]. However, the function integration inevitably brings additional complexity into the design as one part needs to fulfil multiple functions, but due to the design freedom of AM, the added complexity of function integration is not an issue in DfAM [15,16,44,45].

To address the identified gap, this thesis proposes the DfAM methodology for the early phases of the design process that will, through a systematic approach, support the functional modelling of AM products and enable the application of AMK earlier in the design process to facilitate function integration and embodiment of AM based design solutions. In comparison to Pahl & Beitz's design process framework [18], the methodology will cover the conceptual and early embodiment design phases (Figure 1.2). The methodology should enable function modelling and establishment of *function structures* to facilitate the search for a *working principle* and *function integration* through *the mapping process* between product *functions* and *AM Design Principles* (DPs), but also support the design of *form adapted for AM*. Therefore, the concept should specify both the principle solution and its embodiment adapted for AM. The

embodiment refers to the description of concepts in terms of physical structure along with an explanation of how that embodiment works [32] which includes the definition of the preliminary layout of the product regarding form and material selection [18] adapted for AM.

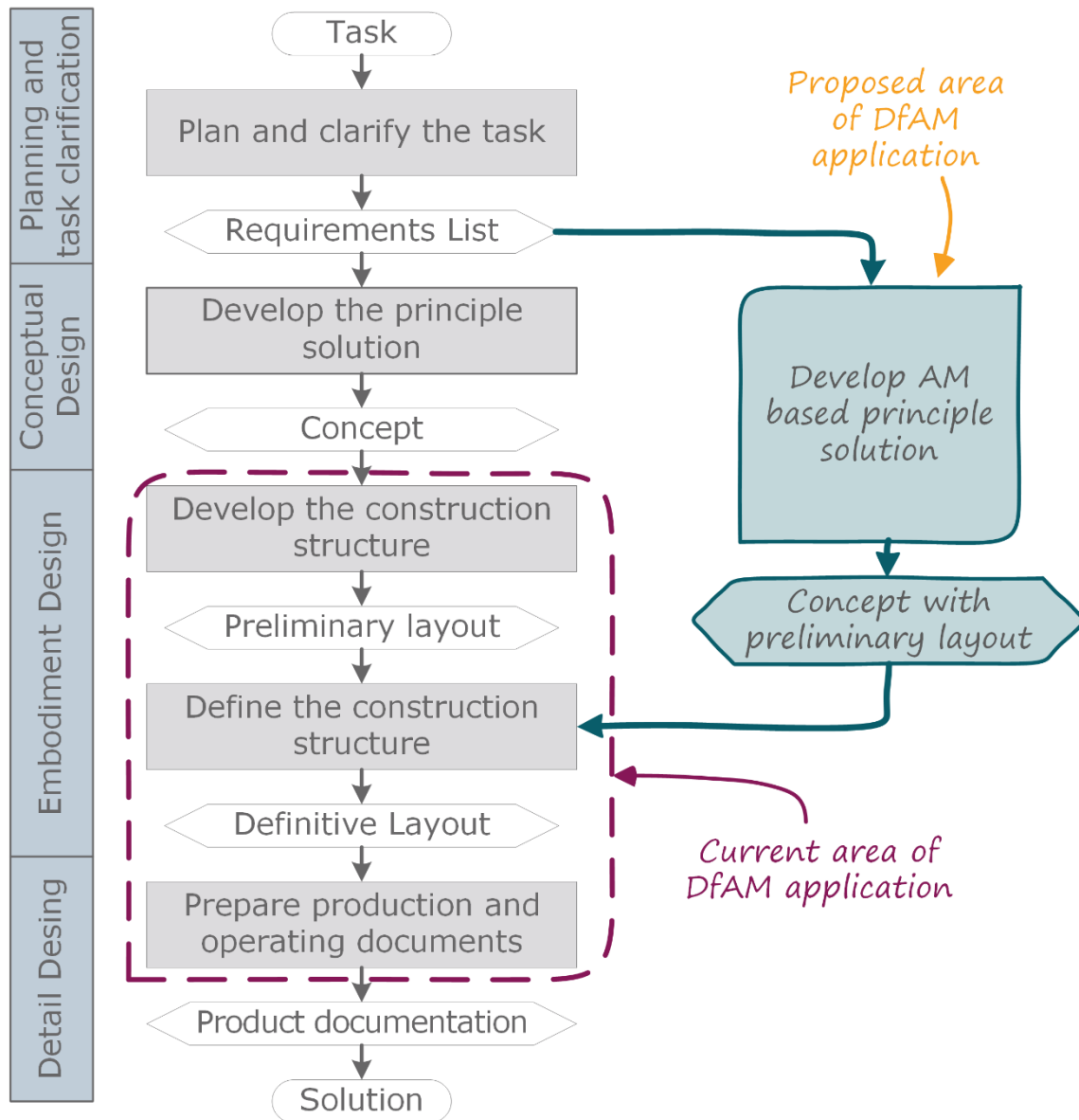

Figure 1.2 Current application of DfAM and proposed application of DfAM

1.2 Research Focus

To develop the DfAM methodology for early design phases, this research is focused on three key topics: function modelling and function models of AM products, sources of AMK for early design phases in the form of DPs, and relations between the product functions and DPs.

The interest in function models emerges from their role in systematic design approaches. The function based systematic design approaches, through abstractions, support the exploration

of design space and helps designers find creative solutions or solutions they would not intuitively think of. The rationale for focusing on the function modelling and use of function models in DfAM are:

- Function models enable abstract and solution neutral representation of the product. They support the conceptualisation on a higher level of abstraction, aid in removing cognitive barriers during conceptualisation and enable a broader view of the design problem,
- Function models are used in many existing design approaches and domains outside DfAM. Hence, many designers are familiar with the concept of function models. This can be used as a solid and familiar point of view when they use DfAM for the first time,
- Function models provide a way for connecting and comparing different phases of the design process. Therefore, the use of function models should enable easier implementation of the DfAM methodology for early design phases into the overall design framework.

The second focus of the research is the AMK. To utilise AM possibilities from the early design phases an appropriate source of AMK is needed. To date, few sources of AMK for early design phases exist (e.g., [46–48]), and they come in various forms like design features, design heuristics and design principles that are not directly mappable with the product functions. Therefore, this research investigates what AMK for early design phases is and how it should be formulated to be mapped with the product functions. While literature suggests different possible forms of knowledge explications to store design knowledge [49], this research primarily focuses on utilising AM DPs as a source of AMK needed for the conceptualisation of AM products. The rationale for focusing on the use of AM DPs are:

- DPs are a form of knowledge explication based on broad empirical evidence, which enables design process guidance and increases the chance of finding an optimal design solution for the given design problem [49],
- The existing literature sources [50] show the suitability of the DPs as a form for storing and using AMK for use in the early design stages of the design process.

Finally, the third focus of the research is the relations between product function and AM DPs. Investigation of relations between function and AM DPs will enable the use of function-to-form mapping in new product development [51–53]. Mapping in a mathematical term refers to any prescribed way of assigning each entity from one set to a particular entity on another set [54].

1. Introduction

Hence, the goal of the proposed methodology is to enable the mapping of product functions and AM DPs to enable the search of AM based solutions and support the conceptualisation of products that will utilise the potentials of AM. The reasons for mapping the function structures and AM DPs are:

- The mapping process will enable the broad search of AM DPs,
- The mapping of function structure will enable function integration,
- The mapping process will enable the embodiment of AM based solutions.

1.2.1 Research Objective

The objective of the research is the development of methods and tools for choosing design principles of additive manufacturing that are used for creating design solutions for one or more functions of a product. The purpose of methods and tools is to help engineers in the early stages of design for the additive manufacturing process to utilise and implement unique possibilities of additive technologies during the design and development process.

1.2.2 Research Hypothesis

The research hypothesis is:

Mapping of functional model of a product with design principles for additive manufacturing in early phases of design process enables function integration and embodiment of design solutions adapted for additive manufacturing.

1.3 Overall Research Methodology

The design research is driven by two main objectives: (i) to formulate and validate models and theories about the phenomenon of the design process, and (ii) to develop and validate the design support built on these models and theories to improve design practice [55]. To achieve these two goals, the design research must be scientific for its results to be valid in both theoretical and practical sense. The scientific aspect of the research is achieved through a systemic and methodological approach to the research activities. The common methodology in design research is the Design Research Methodology (DRM), defined as: “*an approach and a set of supporting methods and guidelines to be used as a framework for doing design research*” [55]. The DRM methodology is adopted for the research project presented in this thesis.

The DRM methodology distinguishes seven different types of research projects. This research project can be described as a Type 5 project - *Development of Support Based on a*

Comprehensive Study of the Existing Situation [55]. The Type 5 research project is used for the development of support when the understanding of the existing situation is poor; hence it includes the comprehensive development of understanding of the research problem and comprehensive development of support. The Type 5 research project consists of four stages described in the following sections.

1) Research Clarification (RC)

RC is the initial stage of a design research project used to identify and formulate a research problem and establish an overall research plan [55]. The review-based nature of the RC stage provides an understanding of current state-of-the-art achievements in the area of research, helps identify the research gap, formulates the line of argumentation and shapes the framework for conducting the research.

The outputs of the RC are Research Focus, Aim and Hypothesis (Section 1.2), Research Questions (Section 2.5) and Research Methodology (Section 1.3).

2) Descriptive Study I (DS-I)

The Type 5 research project utilises a comprehensive DS-I stage, which involves both literature review and empirical study and consists of five steps [55]. Firstly, the literature is reviewed to gain an in-depth understanding of the research area (Chapter 2) and is followed by an empirical study (Chapter 3). This step involves data collection (Section 3.2) and three data analyses (Section 3.2, 3.3, 3.4). In this research, the empirical study is based on the analysis of existing AM products. The comprehensive DS-I stage is highly iterative, involving different methods in each cycle and continuous growth of understanding [55]. The DS-I stage built foundations for the PS stage

3) Prescriptive Study (PS)

Comprehensive PS is conducted to develop design support for mapping product functions and the DPs for AM to such an extent that its functionality can be compared to the purpose for which the design support was developed [55]. This stage builds on the conclusions from DS-I. It includes the definition of a function modelling approach for the creation of functions structure of AM products, consolidation of AMK in the form of DPs for AM, formalisation of Mapping Rules (MRs) and design of an overall methodology for mapping of product functions and the AM DPs (Chapter 4). The stage also includes the development of a computational prototype framework to support the application of developed design support (Chapter 5).

4) Descriptive Study II (DS-II)

The fourth and final stage of DRM, DS-II, is focused on empirical evaluation. This research utilises an initial DS-II approach focused on evaluating the developed method for mapping product functions and DPs for AM and drawing conclusions about relations between the developed support and the aims of the research project [55]. The qualitative evaluation using the case study method is conducted with the goal of indicating the applicability, usability, and usefulness of the developed support, as well as the potential issues, challenges, and future recommendations [55].

1.4 Scientific Contribution

The research conducted in this thesis has two goals, to contribute to the theoretical knowledge of design science and to provide practical design support for design engineers working on the conceptual design of new AM products. Therefore, the expected scientific contribution of the research conducted in this thesis is manifested through:

- Methodology for early phases of product development process that will enable mapping of product functions or sequence of functions with design principles for additive manufacturing.
- Computational prototype framework for supporting mapping of functional model of a product with design principles for additive manufacturing based on proposed methodology with the goal of function integration and embodiment of design solution adapted for additive manufacturing.

1.5 Thesis Structure

The thesis is structured into nine chapters, describing the conducted research with respect to the used DRM methodology. The structure of chapters mapped with the DRM methodology stages is shown in Figure 1.3.

Chapter 1 introduces the research topic and the motivations behind it. It states the research aims, main research question and research hypothesis. In Chapter 1, an overall research methodology is presented, as well as the expected scientific contribution of this work. Chapter 1 is the first part of the RC stage.

Chapter 2 presents a review of the literature regarding the research topic. The literature review covers two main topics of the research, the AM and the function modelling. The first part introduces the overview of AM technologies, where the unique design possibilities of AM and its challenges are outlined, whose understanding is essential for the successful design and manufacturing of AM products. The second part presents the current achievements in the area

of DfAM. It briefly provides an overview of DfAM, but the emphasis is on the DfAM for early design phases. This part describes the latest literature on design support and sources of AMK for early design phases. The third part of the literature review presents an overview of function modelling approaches. The review's focus is on the current achievements in formalising the function model representation through function structure. The emphasis of the review is on the vocabularies for expressing the product functions and rules for function modelling. The fourth part of the literature review outlines the literature sources on the function integration and function mapping methods. Chapter 2 concludes with the description of identified research gaps and a formulation of four research questions (RQs) that guided the research. Chapter 2 is the second part of the RC stage as it further refines the understanding of the research problem. The chapter is also the beginning of the DS-I stage as it provides a theoretical understanding of the observed phenomena.

Chapter 3 presents the conducted empirical research, and it is the second part of the DS-I stage. The chapter firstly introduces the argumentation and framework of the empirical research. This is followed by presenting the protocol for gathering data and the pool of AM products used to conduct empirical research through three different analyses. The first presented analysis is the functional analysis that is conducted to understand and describe how the function model of AM products can be represented. Secondly, the analysis of AM forms on the pool of AM products is presented. The analysis is used for extracting AMK in the form of AM DPs. The final described analysis is the analysis of form-to-function mapping used for formalising the function-to-form MRs. The results of the conducted analyses are used for the development of the Mapping Methodology and its methods and tools.

Chapter 4 presents the proposed methodology for mapping product functions and DPs for AM. This chapter solely corresponds to the PS stage of DRM. The proposed Mapping Methodology is developed on the theoretical background from Chapter 2 and empirical analyses described in Chapter 3. The chapter presents the overall framework of the Mapping Methodology and its two design methods. The first method is a Function Class Method, a function modelling method based on predefined function block templates. The method is supported by modelling rules and Function Classes (FCs). The second method is Mapping Method which uses AM DPs and MRs to suggest potential AM solutions to the designers.

Chapter 5 is the second part of the PS stage. This chapter presents the developed computational prototype framework that supports the application of the Mapping Methodology. The chapter describes the architecture of the computational prototype framework called Function Mapping Application developed as a macro for MS Visio but also presents the two

1. Introduction

operating modes for function modelling and function mapping using the proposed Mapping Methodology.

Chapter 6 presents the case study design for the validation of the developed methodology and is the first part of the DS-II stage. The chapter first provides the overview of case study research and the rationale for using the case study research to validate the Mapping Methodology. This is followed by the development of the case study protocol and preparation of case studies.

Chapter 7 is the second part of the DS-II stage, and it presents the results of the case study research. Four different cases are studied, and each is described and analysed in an individual case study report using a pattern-matching technique. Chapter 7 concludes with the cross-case report presenting the overall conclusions of the case study research.

Chapter 8 reflects on the conducted research. Firstly, four RQs posed at the end of the chapter are discussed. Secondly, the chapter reflects on the characteristic of the DfAM for the early design phases and the validity of the conducted research and research results. Chapter 8 is a part of the DS-II stage.

Chapter 9 concludes the thesis. This chapter summarises the conducted research and discusses the research hypotheses and the scientific contribution of the thesis. This is followed by underlining the research limitations and highlighting the possible directions for future research.

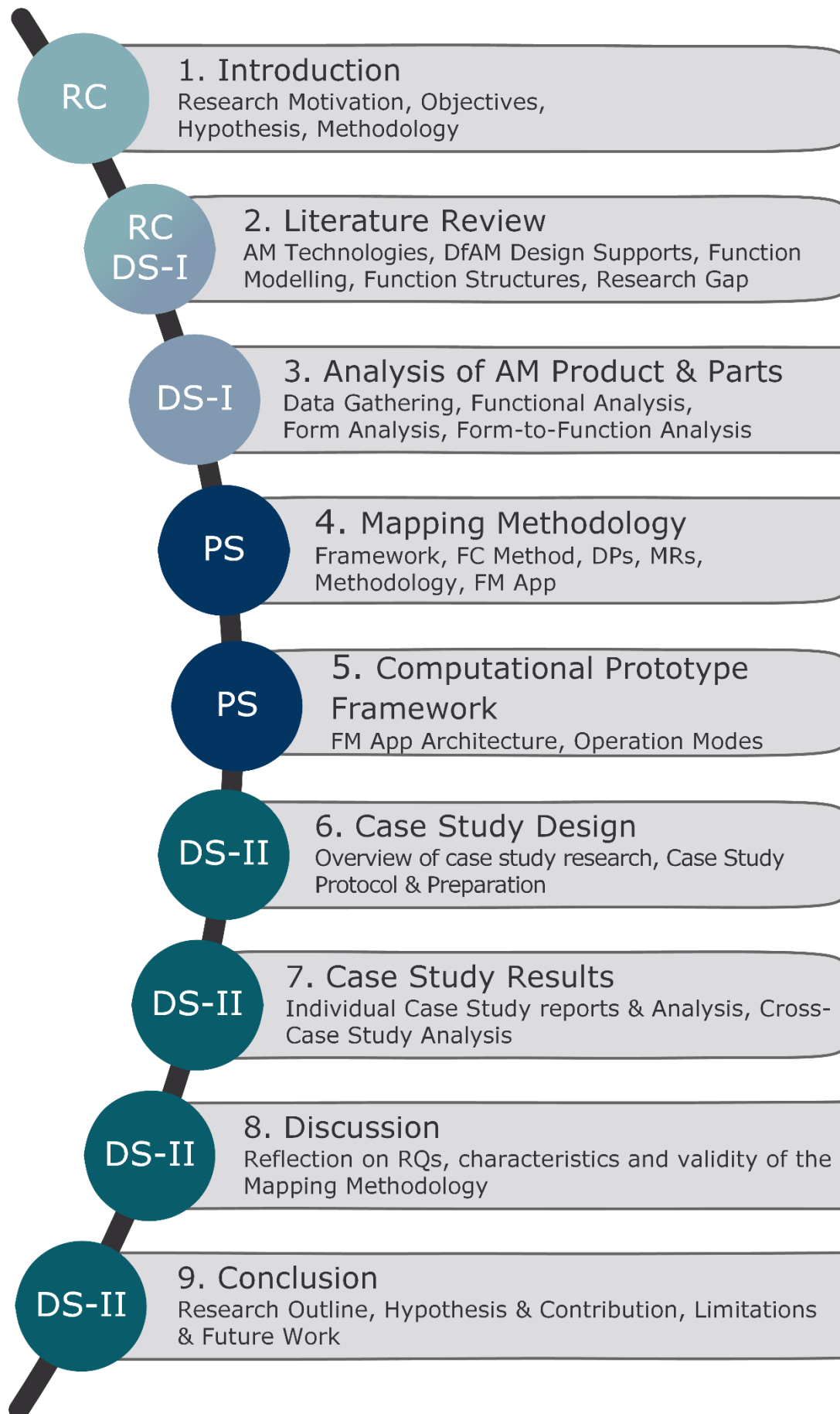

Figure 1.3 Overview of thesis structure

This page intentionally left blank.

2

Literature Background

Chapter 2 is a part of the RC and DS-I stages of the research methodology. Firstly, an overview of AM technology is presented to get insight into the uniqueness of AM and its design potential. This is followed by a review of relevant literature on the topics of DfAM, function modelling and function mapping related to the research focus. The literature review provided further clarification of research and enabled the posing of four RQs at the end of the chapter. Furthermore, the literature review provides the theoretical ground for the DS-I and PS stages of the research.

2.1 Additive Manufacturing

Additive Manufacturing (AM) is a name used to describe a range of manufacturing processes based on the principle of adding material only where it is needed to form an object being fabricated. The AM is a technology with new and unique possibilities that is gaining attention across multiple fields of application, from mechanical engineering, where it has its roots, to civil engineering, medicine, art, food processing and many more [56]. Today, the term AM describes a set of technologies used for manufacturing physical objects from a 3D (3-dimensional) model by adding material, usually layer-by-layer, until the object is completed [1,3]. The term is defined by ISO/ASTM 52900:2021 standard as “*process of joining materials to make parts from 3D model data, usually layer upon layer, as opposed to subtractive manufacturing and formative manufacturing methodologies*” [57].

The AM process usually starts with a clean build plate on which an object is built by adding material one layer at a time, layer upon layer, until the entire object is completed. The AM contrasts conventional manufacturing technologies, especially subtractive ones like CNC (Computer Numerical Control) machining, where manufacturing starts with a block of material, and by removing excess material, a final object is formed [3] (Figure 2.1). The additive nature of the AM enables selective placement of the material and access within the object during the manufacturing process, from which unique possibilities and design freedom emerge [1].

2. Literature Background

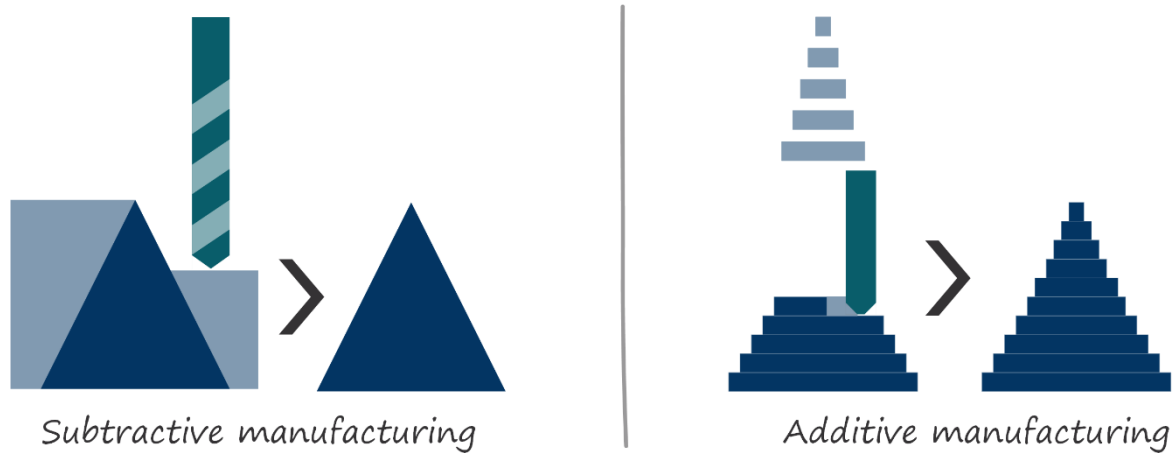

Figure 2.1 Subtractive manufacturing compared to additive manufacturing

2.1.1 Principle & general process of AM

The AM is a direct manufacturing technology as the object is built directly from a CAD (Computer-Aided Design) 3D model without much need for process planning [1]. The objects are made by adding material layer-by-layer, or voxel-by-voxel, with a definite thickness and number of layers. In each layer, the material is added selectively, only where needed, according to the cross-section of an object derived from CAD data. To build an object, every AM process requires a build plate or a chamber, raw material, and energy or adhesive to bond the material. The build process starts with applying and bonding the first layer of raw material. After the first layer is formed, a new layer is formed on top of it. Then, by repeating the steps and building layer upon layer, the whole object is manufactured. During this process, the material and energy are applied, either with selective deposition of material, where material and energy are applied simultaneously or by applying material over the entire layer and selective application of energy across to form a cross-section of fused material [1,3,58,59]. The Material Extrusion process is an example of the former type, and it often requires support structures, while the example of the latter is the Powder Bed Fusion process, where unbonded material can act as a support as it fills the entire build chamber (Figure 2.2).

To successfully build a part every AM process follows, to some extent, the same working process consisting of digital dataflow and physical workflow with six distinctive steps. In the digital dataflow model of an object is created, and instruction data on how to build an object are generated, while in the physical workflow, the AM machine uses the instruction data from digital dataflow to transform the raw material into the final physical model of the object [4]. Some steps are universally applied for all AM technologies, while others are adjusted or omitted when using a particular AM technology [1].

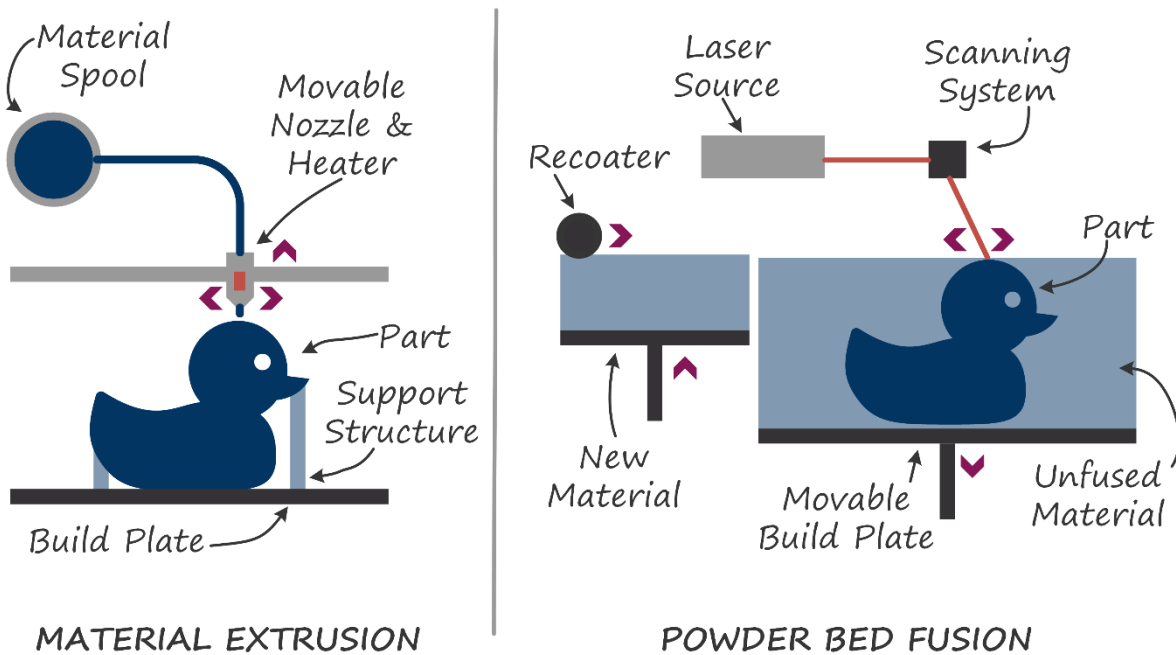

Figure 2.2 Principle of AM through two basic techniques

The process of AM (Figure 2.3) starts with the creation of a virtual 3D model of an object, usually using CAD software or reverse engineering techniques like laser or optical 3D scanning of an existing object. The output must be a 3D solid CAD model or a fully closed surface CAD model, i.e., a “watertight” model. Afterwards, the CAD model is converted to AM compatible data format in the second step. The most common format is STL (Standard Tessellation Language) [60], where the object's surface is described through an approximation of triangle facets. The gradient of the triangulation can directly impact the quality of the final physical object. While STL is a popular format, it does not store any additional data besides the object's shape; thus, new formats like AMF (Additive Manufacturing File) [61] and 3MF (3D Manufacturing Format) [62] emerged. Both formats greatly extend the capabilities of data conversion and transfer as they can store additional information about the object being fabricated with AM, such as colour, material, texture, support structures, lattice structures, and other AM related information [61,62]. In the final step of the dataflow, the 3D model is loaded into preparation software, i.e., a slicer. Here the model is positioned and oriented in a virtual build chamber, and building parameters like temperature, scanning/deposition speed, layer thickness and infill are adjusted [63]. Also, in this step, support structures can be added and edited. When the digital setup is completed, the model is sliced on a finite number of layers and information about each cross-section layout and build parameters are stored [64], e.g., in G-code or Common Layer Interface (CLI) [65] data format, and transferred onto an AM machine.

2. Literature Background

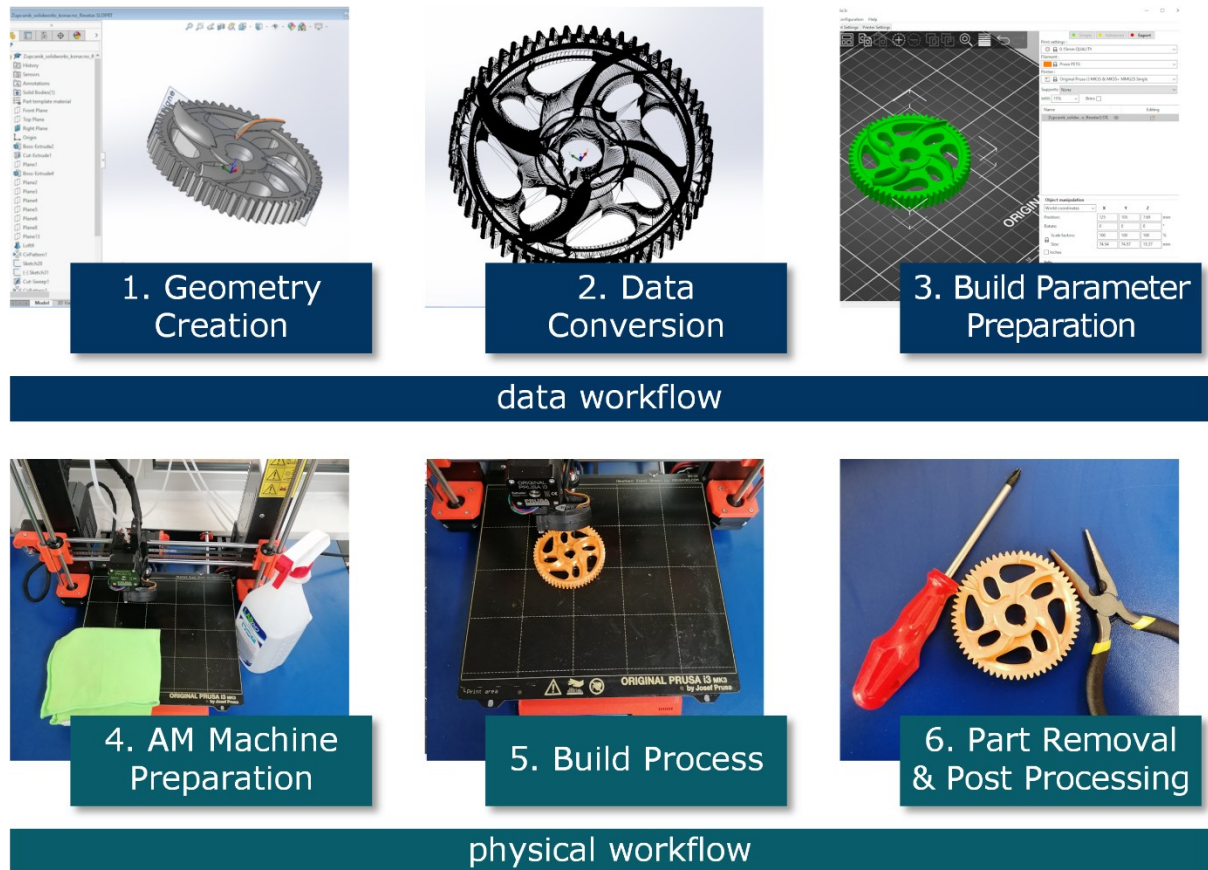

Figure 2.3 Generic AM process workflow

The physical workflow of an AM process starts with machine preparation. This step is highly dependent on the type of AM process and particular AM machine, but usually set up consists of cleaning the machine, its calibration, filling a new supply of raw material, filling the chamber with inert gas if required, and preheating the machine. The build process is highly automated and requires only slight monitoring to ensure the building goes without any simple errors like running out of material. Sometimes build errors can occur, like weak adhesion to a build plate or partial material solidification. In cases like this, it is usually possible to adjust the build parameters like temperature and speed of depositing material on the machine itself while the process is running. If the error is significant, the build process can be aborted. Finally, once a build process is completed, a part must be removed from the build chamber and, if necessary, post-processed. In post-processing, various operations are conducted, such as cleaning excessive material, removal of support structures, further solidification under UV (ultraviolet) light and heat treatment to achieve desired material properties or sterilisation for use in medical practice. Furthermore, additional processing for aesthetic reasons can be applied, like sandblasting or painting, to achieve the desired surface finish. [1,3,58]

| 2.1.2 AM processes and materials

Today, several different AM processes exist, with the main differences between processes being in the type of raw material used and the energy source or adhesive needed for material bonding. Raw material can be liquid, resin, paste, wax, powder, or solid (in the form of wire, film, sheet, or granules). The usual energy sources used are UV light, thermal energy, laser beam, electronic beam, or adhesives like glues and resins [1,58]. The ISO standard 17296-2:2015 [66] classifies AM processes on; (i) vat photopolymerization, (ii) sheet lamination, (iii) material extrusion, (iv) powder bed fusion, (v) direct energy deposition, (vi) material jetting, and (vii) binder jetting. A short overview of AM processes, together with their commercial names, available materials, and their raw state, as well as the power source used for material bunding, is shown in Table 2.1.

As can be seen from the table, many different materials are used in engineering practice. Still, the most common are polymers and metals for manufacturing both prototypes and final end-user parts. A wide variety of polymers are available on the market with different mechanical properties and colours for all sorts of applications, such as prototyping, soft tooling, everyday production, and medical application. For example, polyamides, polystyrenes, thermoplastic elastomers, polycarbonate, acrylonitrile butadiene styrene, acrylonitrile styrene acrylate, and polyaryletherketones are just some of the more popular types of polymers offered on the market [1,58,59]. Similarly, many metals and alloys are available on the market for different applications, from everyday production, rapid toolmaking, dental and medical application to materials used in the aero and space industry. Commercially available materials include aluminium alloys, maraging and high-grade stainless steel, titanium alloys, as well as nickel and cobalt chrome alloys [1,3,58,59].

Every material processed by AM machine has its own set of parameters required for a successful build, such as deposition or scanning speed, temperature of the nozzle or laser power, the temperature of the bed or build chamber, and many others. The control of the parameters is critical for the quality fabrication of the parts. Furthermore, control of parameters can be used to control material structure and properties in different areas of the part, providing another capability over the conventional manufacturing processes where material properties are mostly uniform across the part [1,3]. For example, by varying the temperature and scanning width, different densities of material can be achieved throughout the part, or when the support structure is made from the same material as a part, a different combination of the parameters is used to make support weaker and thus easier to remove.

Table 2.1 Overview of AM processes

CATEGORIES Commercial technologies	COMMERCIAL MATERIALS	FORM OF RAW MATERIAL	POWER SOURCE TO FORM AND BUND MATERIAL
VAT PHOTOPOLYMERIZATION Stereolithography (SLA) Digital Light Processing (DLP)	photopolymers, ceramics (alumina, zirconia)	resins	ultraviolet light, radiation, visible light, electron beam
SHEET LAMINATION Laminated Object Manufacturing (LOM), Layer Laminate Manufacturing (LLM)	plastics, metals, wood, paper,	sheets, films	mechanical cutter, laser beam, ultrasound, adhesive and thermal bonding
MATERIAL EXTRUSION Fused Deposition Modelling (FDM)	thermoplastics, metal pastes	wire	thermal energy
POWDER BED FUSION Selective Laser Sintering (SLS) Direct Metal Laser Sintering (DMLS) Selective Laser Melting (SLM) Electron Beam Melting (EBM)	polymers, different alloys, titanium, stainless steel, cobalt chromium	atomized powder	laser beam, electron beam
DIRECT ENERGY DEPOSITION Laser Engineered Net Shaping (LENS) Electronic Beam Welding (EBW)	metals	powder, wire	laser beam, electron beam
MATERIAL JETTING Polyjet/Inkjet Printing	photopolymers, wax	resins	thermal energy, photocuring
BINDER JETTING 3D Printing (3DP)	polymers, ceramics, metals	powder, resins	thermal energy, photocuring

Furthermore, some AM processes can process more than one material in a single build through Multiple Material Additive Manufacturing (MMAM). MMAM can be used for improving part performance by varying different materials or material compositions between layers or in the single layer itself [67], but also for aesthetics by using different colours of materials. Also, MMAM enables the use of dedicated support material that is different from the product's material. The support material can then be either a cheaper material to reduce the cost of sacrificial structures or a soluble material that is easier to remove.

2.1.3 Characteristics of AM

AM brought new possibilities in the manufacturing and design of products [2], but AM has its advantages and disadvantages like any other manufacturing technology. Therefore, for the

designer who designs products for AM, it is necessary to understand the characteristics of AM and how to utilise the advantages of AM while avoiding or minimising the disadvantages. Furthermore, as AM is a direct manufacturing technology that does not require tooling or fixtures [68], it is essential to consider characteristics beyond material properties and geometrical accuracy, like digital discretization of a model, need for the support structure and build time.

The additive nature of AM enables unprecedented design freedom compared to conventional manufacturing technologies. The selective placement of the material, the possibility to process different materials, and the possibility to access the inside of the product and change of parameters during fabrications enable customization, performance improvements, multi-functionality, and lower costs of manufacturing [69]. These capabilities and unique possibilities are manifested through four complexities of AM: geometrical, material, hierarchical and functional complexity [1,70].

Geometrical complexity refers to the possibility of building almost any shape imaginable to the designer [1]. Such design freedom is possible because there is no need to consider manufacturing restrictions imposed by conventional manufacturing processes. Therefore, customized geometries and shape optimization features are easy to manufacture. A notable example of AM's geometrical complexity is topological optimisation (TO) (Figure 2.4). TO shapes are determined by the ideal material distribution for the given design objectives and load cases [3]. Consequently, the TO shapes have a complex geometry which is hard or even impossible to manufacture with conventional manufacturing processes but is easily achievable with AM. The benefits of using TO shapes are mostly notable for weight reduction, thus, TO is often used in the aerospace industry [71], where the savings in overall weight can reduce operating costs.

Material complexity derives from the material processing of AM layer by layer or even point by point [1]. Therefore, it is possible to change the type of material in each layer or point of the part through MMAM. Additionally, with the change of process parameters, it is possible to change the material's microstructure in different areas of the part through FGM. Both possibilities enable the manufacturing of a part with complex material composition, thus enabling optimization of the mechanical properties of the part. Figure 2.4 shows an example of MMAM, where materials of different colours are used for aesthetic purposes.

Hierarchical complexity is related to the build sizes of AM and the possibility of manufacturing multiscale features from nanostructures, microstructures, and mesostructures to part-scale macrostructures [1]. It is possible to manufacture design features on one scale of the

2. Literature Background

size that has an embedded sub-feature of a smaller scale, and this sub-feature can have even smaller features and so on. An example of hierarchical complexity is the use of lattice structures in AM parts. Lattice structures are cellular structures made by repeating patterns of a unit cell in a larger volume [3]. There are many applications of lattice structures, for example, weight reduction in a part, improvement of strength-to-weight ratio, or mimicking the bone structure in implant production [3] (Figure 2.4).

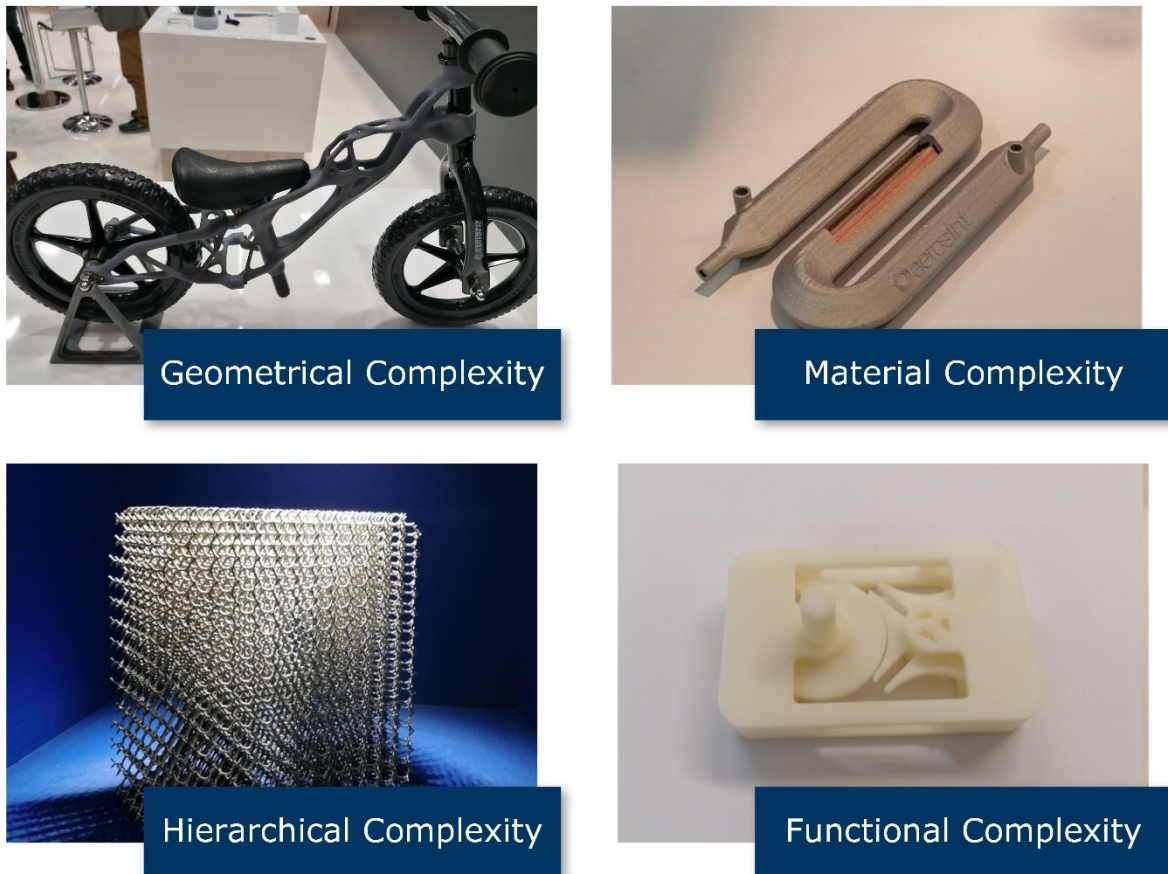

Figure 2.4 Examples of four AM complexities

Functional complexity refers to the possibility of producing fully functional devices and mechanisms in a single build [1]. This can be achieved in two ways. Firstly, it is possible to produce assemblies and mechanisms with different types of joints by controlling the clearance between components in the build (Figure 2.4). Secondly, it is possible to embed prefabricated parts into AM part during the AM process. Both possibilities give new design freedom and reduce the assembling operations during the post-processing phase.

While AM brought new design possibilities and removed many of the limitations that exist in conventional manufacturing, such as the need for uniform wall thickness or the necessity to avoid undercuts and to add drafted surfaces [72], it has its own set of restrictions and limitations one needs to be aware of. One of the most significant constraints of AM is the anisotropic

properties of a fabricated part [1]. Due to production in layers, the mechanical properties of deposited material are different in the building direction compared to properties in a direction parallel to layers. These properties are usually poorer and can significantly impact product performance. Part orientation during build must be considered and adjusted to avoid and minimize this effect. An additional problem associated with production in layers is the occurrence of delamination if the layers are not bonded properly [1]. This effect can occur during the build when it can also damage the AM machine or during cooling, post-processing, or part application.

Furthermore, the scale of product size is dependent on the technology and applications, with commercially available AM machines providing sizes for mechanical engineering applications from a few millimetres to a few thousand millimetres. Geometrical and dimensional accuracy are usually lower than milling and similar technologies and depend on the system's size, the type of process used, and specific parameters of the machine [5]. In general, AM cannot achieve fine tolerances and geometrical accuracy but rather requires post-processing for fine tolerances, accuracy, and surface finish. The digital spectrum also influences geometrical and dimensional accuracy. For example, the tessellation process directly impacts surface representation and later fabrication of curved surfaces, while slicing the digital model and fabrication in layers can cause a so-called “staircase effect” [3].

Another limitation of the AM is the need for support structures in many processes. The AM workpiece is influenced by different internal and external factors like recoating forces, thermal and residual stresses, and its own weight. To cope with these factors, anchoring and supporting structures are needed depending on the product's shape and AM process [73]. These structures come in different forms, as unfused material surrounding the workpiece, as support structure integrated into the design of a product, sacrificial support made from the same material, or as different (cheaper or soluble material) that is removed in post-processing. The supporting structures are a limiting factor in design, surface quality, post-processing, and building volume utilisation. Therefore, engineers working with AM must be aware of both advantages and limitations of AM described in this section.

| 2.2 Design for Additive Manufacturing

Over the years, the development of AM technologies transformed the AM from being only the rapid prototyping technology to technology for manufacturing end-use products for customers, and with this transformation, a need for AM knowledge (AMK) and new design methods emerged [74]. Furthermore, AM changed not only how the products are made but also

2. Literature Background

the type of products being made. To fully utilise the unique possibilities of the AM, it is necessary to change the paradigm of how the products are designed for AM [2]. For these reasons, but also due to the unique possibilities and limitations of AM described in Section 2.1.3, researchers started to investigate how to design products for AM. This led to the development of the DfX methodology known as Design for Additive Manufacturing (DfAM). DfAM can be defined as *a design methodology where design criteria are focused on the unique capabilities of AM, as well as its limitations, that through a set of methods and tools guide designers and support the design process of products with new functions, forms and material compositions enabled with AM* [15,16,42].

| 2.2.1 DfAM Categorisation

Today DfAM contains a wide range of approaches for supporting all stages of AM oriented design process and utilisation of AM potentials. According to Blessing & Chakrabarti [55], design support includes all techniques that can be used to improve the design and are divided into: (i) design approaches or methodologies that provide an overall framework for doing design, (ii) methods composed of a sequence of activities to improve a particular stage of design process, (iii) guidelines used to accomplish some design objective and (iv) tools as a form of hardware or software support based on some previous type of design support.

Inside DfAM, various categorisations of design support exist. For example, Laverne et al. [75] make a distinction between “DfAM for concept assessment” and “DfAM for decision making”, where the latter is subdivided into “Opportunistic DfAM” and “Restrictive DfAM” [15]. Likewise, Yang and Zhao [76] distinguish “general design guidelines”, “modified conventional design theory and methodology for AM”, and “Design for Additive Manufacturing”. On the other hand, Kumke et al. [77] divide DfAM into “DfAM in strict sense” which includes approaches for the core design process and activities, and “DfAM in the broad sense” which includes approaches beyond the core design process, while Pradel et al. [10] map different approaches onto the design process phases.

Combining the categorisation of design support [55] with existing DfAM categorisation and mapping them onto a design process as prescribed by Ulrich & Eppinger [32] overview of design support for DfAM over the entire design process and on four levels of granularity can be seen in Figure 2.5.

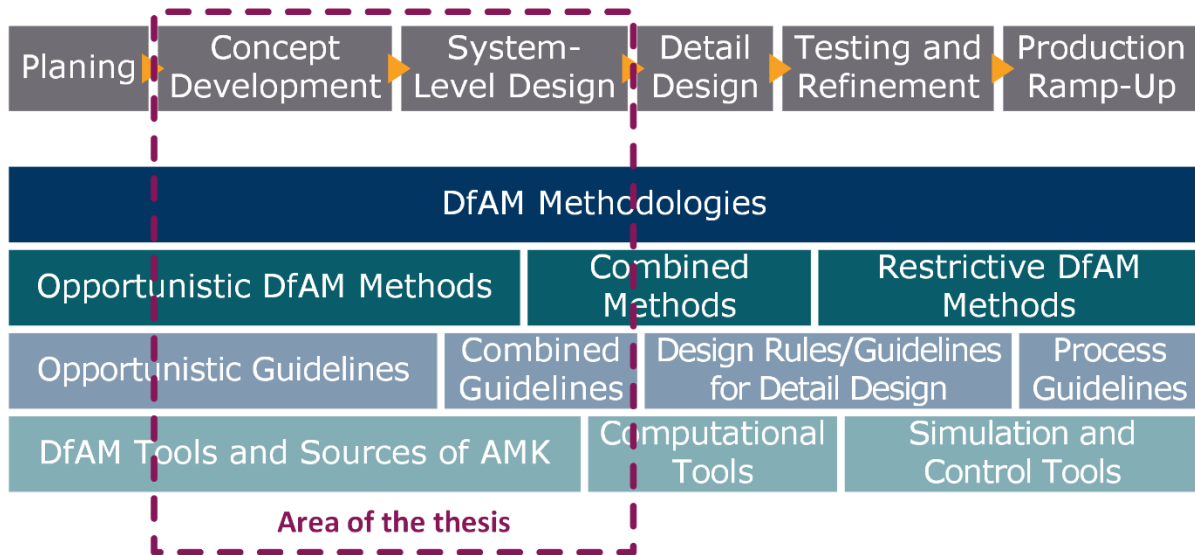

Figure 2.5 DfAM design support overview

Most approaches developed to date, especially those so far implemented in industry practice, are mainly focused on later design phases of embodiment and detail design [9,10]. These approaches primarily consist of different sets of restrictive DfAM methods, rules, and guidelines to determine design and manufacturing parameters and ensure the feasibility of features and the manufacturability of the part, and from computational and simulation tools for the design of complex shapes and AM process control. These approaches have immense value for detailing the final design and ensuring the manufacturability of the product. However, as they are applied after the concept and layout of the product have been established, their influence on functionalities, layout, and form is relatively small. Usually, they utilise only a fraction of the AM potentials.

On the other hand, the uniqueness of AM enables new forms and functionalities of products, allowing new possibilities for innovative design often needed to satisfy customers' needs and stay competitive in the market. A structured design process is a basis for developing innovative products, and early design phases where designers go from concept to preliminary layout are essential for innovative design [78]. Thus, the early design phases have a vast influence on the embodiment and detail design of a product [18]. Designers working with the AM recognised the importance of applying AMK early in their design processes but are facing a lack of DfAM support for early design phases [9]. As the thesis is focused on the early phases of DfAM (Figure 2.5), the four types of DfAM design support in the context of early design phases are thoroughly reviewed in the following sections.

| 2.2.2 DfAM Methodologies

Design methodologies are the broadest type of design support and, as such, provide the overall framework for conducting the design process and provide support and guidance through the entire design process or several design phases [55]. Design methodologies in the context of DfAM provide the framework for the design process that incorporates the specificities of AM in various stages of the design process. By prescribing general steps of design activities in various phases of the design process and defining inputs and outputs for each step or phase, DfAM Methodologies provide guidance throughout the design process. The DfAM Methodologies vary in the level of detail for the prescribed steps of the design process. While some include only major steps (e.g., [79]), others have multiple steps, modules, and detailed guidelines for conducting the AM design process (e.g., [77]). Furthermore, as the broadest type of AM design support, DfAM Methodologies have a universal approach independent of the AM process used. However, some methodologies foresee applying specific AMK when the decision on the manufacturing AM process is made during product development.

The DfAM Methodologies provide the framework for conducting early phases of the design process and enable integration with other phases by defining inputs and outputs between phases. Various approaches provide different prescriptive steps for conducting early design phases. Kumke et al. [77] proposed the overall DfAM framework based on VDI 2221 procedure. Through its modular design, the framework enables the incorporation of different modules for specific AM design tasks and the integration of generic design methods and tools and DfAM specific approaches. The AM potentials are utilised in early design phases through association aids, such as AM design feature database [46], and further developed with other modules like general creativity techniques. A similar framework was also proposed by Segonds [80], where the conceptual design phase is based on Rias et al. [81,82] creative approach, and it is intended to enable the exploitation of unique AM possibilities.

While the above methodologies integrate creative approaches in conceptual design, Renjith et al. [79] proposed the DfAM methodology based on the Axiomatic Design Theory and TRIZ (Theory of Inventive Problem Solving). The conceptual phase consists of formulating the design problem in an axiomatic design framework, using TRIZ to derive design parameters for mapping with AM capabilities found in the AM database and applying them to create the concept. Kaspar et al. [83] and Zaman et al. [84] extended the DfAM methodologies by considering the manufacturing process and its characteristics during the design process. A variety of working principles, manufacturing technologies (including AM) and materials are

assessed against technical, economic, and ecological criteria [83] as well as resource selection [84] already in early design phases.

| 2.2.3 DfAM Methods

Design methods support a particular design stage or specific design task during the design process and aid the designer by prescribing a sequence of tasks or activities that need to be performed [55]. In the early phases of AM oriented design process, DfAM Methods support the ideation and enable the utilisation of AM possibilities. Their workflow is usually composed of divergent phases for generating ideas and exploring design space, a utilisation phase where concepts are created and a convergent phase for concept assessment. The methods are not always linear but rather iterative, with the repetition of some or all steps and activities.

To support the utilisation of AMK in assembly design, Laverne et al. [15] developed a method for AM conceptual design of assemblies. The method splits the early DfAM phases into four stages used to identify requirements, generate concepts, working principles and working structures with specific AMK applied in each phase. The method's goal is to improve the design features by referring to both possibilities and constraints of AM using intermediate representations as checkpoints. Similarly, Rias et al. [81,82] proposed a five-step concept generation and evaluation method. The specificity of the method is the discovery of product features by looking at intra-domain and far-domain examples used for idea exploration in the creative process. This is followed by an evaluation of ideas regarding AM feasibility before concepts are generated and evaluated. Afterwards, a new divergent phase of concept generations is conducted, followed by another convergent phase of concept evaluation.

Another method to foster designers' creativity is a combination of the Disney Method with DfAM Tools proposed by Kumke et al. [85]. In a "Dreamer" phase, mood boards are used for generating ideas, followed by the "Realist" phase, where physical models of AM design potentials are used together with a proposed interactive system for AM design potentials. These tools allow designers to explore the AM design space and are intended to foster inspiration and ideations by creating awareness of the new design freedom and its utilisation in end-use products. Finally, in the "Critic" phase, AM design rule collection is used to evaluate the generated ideas. The method is highly iterative, and the conducted ideation sessions showed the benefits of the proposed method and its possibilities in utilising AM. Likewise, the research group from SUTD-MIT investigated the influence of DfAM on innovation [86–88]. As a result, they developed the Design Innovation with Additive Manufacturing (DIwAM) methodology based on the Design Innovation framework with the goal of understanding AM, developing a

2. Literature Background

set of creative solutions, and testing and delivering an innovative product that takes advantage of AM.

On the other hand, Gross et al. [89] proposed a DfAM method based on TRIZ. The method is based on a matrix of contradictions among improving and worsening AM design features. The offered solutions are 156 different design rules categorised in 18 inventive principles that populate a new AM TRIZ matrix. The rules and details of the method are not fully disclosed, but the intention is to find a creative solution for solving AM contradictions throughout the design process. Similarly, Leutenecker-Twelsiek et al. [90] also considered the limitations of AM in early design phases through the method for defining part orientation in the early design stages. The method is used for reconfiguration of the AM concept, where the concept is decomposed into design elements to determine the best orientation for each element and to establish a new layout of the concept according to AM limitations.

Furthermore, AM limitations are the focus of a method for the redesign of existing designs proposed by Borgue et al. [91]. The method utilises the advantages of AM during the redesign and, at the same time, considers its limitations. It is based on Enhanced Function-Means modelling (EF-M) [92], where first, the EF-M model with existing manufacturing constraints is developed from the original part. Then, the original constraints are removed from the model and substituted with AM constraints in the next phase, and the new EF-M model is used for a redesign. The method enables partial utilisation of AM potentials as the EF-M used is based on the original part designed for conventional manufacturing, and the method focuses on the AM manufacturing limitations. Nevertheless, the method uses AM's advantages and supports the redesign of existing parts in the early design phases. Functions are also the focus of Yang and Zhao's [93] "Function-behaviour-functional entity-functional feature design synthesis strategy" for conceptual redesign and application of AMK. The method aims to decompose functions of existing design and enable the synthesis of new functional features according to AM and, through it, form a new design space. The method facilitates the design synthesis and enables function integrations, but it is limited only to redesign context, as the CAD model of a product is needed as input.

Finally, Markou et al. [94] proposed the DfAM method for early design stages with environmental considerations. The method consists of the divergent phase, where the design space is explored, and the convergent phase, where concepts are created. The method suggests the use of three tools for environmental assessment: (i) Lifecycle Design Strategies (LiDS) wheel for AM technologies, (ii) card with an overview of AM processes and (iii) AM Material

Card. With these tools, environmental considerations are incorporated into concepts before evaluating concepts using Strengths, Weaknesses, Opportunities and Threats (SWOT) analysis.

| 2.2.4 DfAM Guidelines

Design guidelines come in various forms such as rules, principles or heuristics and are used to achieve a particular design objective [55]. While the guidelines for embodiment and detail design were developed parallelly with the AM technology in the form of rules for ensuring the manufacturability of AM designs (e.g., [20,95–97]) and are well established, the DfAM guidelines for early design phases are relatively new development inside the DfAM. Such guidelines are used to inspire designers to explore the AM design space, evaluate the possibilities of AM, and to enable conceptualisation of AM products. An essential aspect of hitherto developed DfAM guidelines for early design phases is their role as a source of AMK. Some guidelines are focused on the exploration of AM potentials and unique capabilities during conceptualisation to foster creative ideation, while others also include AMK about AM limitations for early assessment of design ideas.

The first developed source of AMK for early design phases is the design feature database by Bin Maidin et al. [46,98]. The design features database contains 106 design features organised in a taxonomy based on reasons for using AM (user fit requirement, improved functionality, parts consolidation, aesthetics) and type of application. The designer navigates through design features by answering 11 questions to find appropriate design features for the given design problem. The design features provide ideas and solutions that can be incorporated into AM products. The developed DfAM features primarily focus on geometrical complexity and shape enabled with AM. On the other hand, Blösch-Paidosh & Shea proposed the use of AM design heuristics that utilise all four types of AM complexities [14,47,99]. They initially developed a set of 29 AM design heuristics that were later redefined into the final set of 25 process independent AM heuristics in which broad AMK is captured. Heuristics are a source of AMK focused solely on unique AM possibilities and do not contain remarks regarding the limitations of AM. Heuristics should be used during ideation sessions, focusing on the transfer of AMK relevant in the early phases of the design process to both novice and experienced designers. Heuristics aim is to foster designers' creativity and, through AMK on a high level of abstraction, enable utilisation of AM possibilities in generated concepts. The developed AM heuristics are organised into eight thematic categories: *part consolidation*, *customisation*, *information communication*, *materials*, *material distribution*, *embed-enclose*, *lightweight*, and *reconfiguration*. AM heuristics are also used by Lindwall & Törlind [100] for fostering ideation

2. Literature Background

in the context of using AM in the aerospace industry. Their set of 10 AM design heuristics is mapped onto existing Design for Manufacturing (DfM) and Design for Assembly (DfA) guidelines and categorised into three design areas: part consolidation, connection elements and structure design.

Weiss et al. [37] proposed the concept of a design catalogue for additive manufacturing compliant solutions. The catalogue is based on classical German design catalogues (e.g., [101]) with AM solutions categorised according to the product function they are solving. Each solution is explained and commented on regarding manufacturability with different AM processes. Furthermore, each AM solution is compared with a similar conventional design due to premisses that AM solution will be easy to understand because most designers will know the conventional solution. The AM design catalogue will be a valuable source of AMK, especially if the systematic design process is followed (e.g., [18]), but unfortunately, no version is publicly available. A similar approach is also used by a research group from *Technische Universität Braunschweig*, who proposed the use of AM design feature catalogue to be used in combination with creativity methods like Brainstorming, Method 635 and the Disney method [102]. The same research group later reported the development of 23 AM Design Principles (DPs) as a source of AMK for conceptual design [39]. DPs are organised in a matrix based on the general functions and operating flows. The matrix suggests the intention of using DPs as a partial solution for an individual function like in Pahl & Beitz [18] systematic design approach, but no details were given. At the same time, they also developed a separate set of 41 solutions principles based on the potentials of MMAM [40]. The solution principles are also organised in a matrix for function-oriented access. Neither of the three reported approaches are publicly available.

The research group from SUTD-MIT developed a set of 23 AM design principles that are derived from the analysis of a crowdsourced repository of AM design data [48,88,103]. Principles extracted relate to manufacturing and assembly, digital manufacturing, and AM, focusing on the FDM process, as most analysed artefacts are optimised for FDM. The principles are intended to be a source of AMK and should help designers to create innovative solutions, primarily when used with the previously described DIwAM methodology.

| 2.2.5 DfAM Tools

Design Tools are low-level support for supporting operational and proficient use of methodology, method, or guidelines [55]. Therefore, the development of DfAM Tools for early design phases is closely related to the development of a particular method or guideline they

support. The DfAM tools exist as hardware and software tools and are used as a source of AMK, tools for ideation and inspiration, and evaluation tools.

Software tools are mostly used as a source of AMK. Bin Maidin et al. [46] used the *MS Access* database for storing AM design features. The database uses questions to navigate designers to the appropriate design feature described with its name and ID number, the application and aim category, functionality keywords, AM process and material information, and a graphic of a design feature. Another approach for storing AMK is a collaborative web-based DfAM Wiki repository proposed by Doubrovski et al. [74]. They conducted a pilot study where the participants were responsible for creating and editing the AMK stored in the Wiki repository. As AMK is continuously evolving, due to constant advances in AM technology, it is challenging to capture, store and edit such a dynamic volume of knowledge, but the study showed the potential of a collaborative effort in such application. Similarly, Kumke et al. [85] store the AMK in the web-based application called “Interactive system for AM design potentials” made of dynamic network charts, digital 3D models and a collection of the AM case studies, but their approach is not intended for collaborative editing. The research group from Braunschweig also uses a web approach through online cards for search and representation of the design principles, where each principal card contains various elements, form title, ID, and description, to example, graphics and links to other solutions [39,40]. None of these tools is publicly available.

DfAM hardware tools are used for inspiration, design knowledge sources, and evaluation tools in the early design phases. Two common forms of hardware tools are cards and 3D objects. The cards are used as a source of AMK to explain the possibilities and sometimes restrictions of AM, as well as sources of inspiration in ideation sessions due to the graphical and exemplary representation of AMK. SUTD-MIT research group [87,104] developed a set of AM Principle Cards. Each card describes one AM DP through categorisation, short description, graphic representation of the traditional and principled solution, and well as examples. DPs are divided into four categories: product, business process, design process and printing. Cards are also used for representing heuristics. Blösch-Paidosh & Shea developed a set of cards where each heuristic is described with title, category, short text description, sketch and an example of a utilised heuristic on a single card [14,105,106]. Together with AM heuristics cards go supplementary 3D objects called *Design Heuristics for AM Objects* [14,105], a physical 3D representation of each AM heuristic. The objects are used for easier understanding of heuristics but also as a source of inspiration in ideation sessions [106]. 3D objects are also used by Rias et al., who proposed the use of an intermediate physical representation called Additive

2. Literature Background

Manufacturing of Intermediate Objects (AMIO) [82]. The AMIO objects embody the ideas generated in the ideation session. As they are physical objects, they link mental understanding of a generated idea and its tangible experience. They can foster the perception of the idea, stimulate creativity, and be used for early technical validation. Kumke et al. [85] also developed 3D models for presenting the AM potentials. When manufactured, models enable physical interaction and foster ideation, especially with novices in DfAM.

Another proposed DfAM tool is the AM Design Catalogue [37], where AMK is stored in the form of principle solutions, similarly to existing design catalogues used in German literature. However, the entire development of the catalogue was not reported. The same authors developed a paper tool for evaluation in conceptual design where a worksheet is used to select the manufacturing process in the early design stages [107]. As the AM technologies vary in their characteristic, the proposed tool enables the assessment of concept or product characteristics regarding different AM technologies. Similarly, Booth et al. develop the DfAM Worksheet, a tool that aids in the evaluation of concepts or CAD models regarding manufacturability [108]. Although the tool does not help generate concepts, it can help designers assess the feasibility of the concept and avoid or redesign features that are hard or impossible to manufacture.

2.3 Function Modelling

The goal of engineering design is to find an optimum solution for the given design problem [18]. In this search, designers must examine different possible solutions but are often limited by their familiarity with previous designs, the domain of expertise, familiarity with a particular technology, design fixation, etc. To broaden the search, remove the conscious and unconscious limitations, and explore new design possibilities, designers use the abstraction of the design problem to remove the barriers and provide an independent view of the design problem [18]. When conducted properly, it produces the overall function of a product to be designed. Function describes what a product must do to satisfy engineering requirements and user needs [29]. However, it does not state *how* to fulfil engineering requirements and user needs; in other words, the function is independent of the form and technical ways of achieving it. Therefore, the function provides an abstract and independent description of the product without the commitment to product form. However, the abstract nature of the product function imposes different challenges: how to define what is a function of a product, how it should be expressed, what is the process of creating a function model, and how can the function model be represented. The following sections provide the literature overview regarding these challenges.

2.3.1 Function & Function Models

Function as a description of a product independent from its form has always been the core concept of many prescribed systematic design approaches and concepts of great interest in design research (e.g., [18,28–31]). Over the years, dozens of different definitions of what a function is have been proposed (Table 2.2). The common denominator among the different definitions of the function is that it represents what a product or a system must do independently of the technical way and physical form of how the function is fulfilled in a final product. The function is an abstract representation of product intention, and it is often described through the transformation of energy, material, and information flows [18,28].

Most of the literature sources distinguish between the overall product function and product subfunctions [18,28,31]. The overall product function describes the highest function that a product must fulfil to satisfy all requirements and user needs [28]. Usually, to solve the overall function of a product, there is no straightforward solution, and multiple design solutions are combined. Therefore, the overall product function is decomposed into subfunctions [18]. Subfunctions are components of the overall function and represent the underlying tasks of the product [28,109]. By linking the subfunctions together, the overall product function is described in the form of a function model [110].

Table 2.2 Selected function definitions from the literature

Author	Definition
Caldwell et al. [110]	<i>A function is a solution-neutral representation of the process of converting a set of inputs to a set of outputs</i>
Deng, Britton & Tor [111]	<i>System viewpoint: here a function is viewed as a relationship between the input, the output, and the state variables of a system Performance viewpoint: here a function is viewed as an abstraction of physical behaviour Designer viewpoint: here a function is viewed as a description of design intention, i.e. the intended purpose of a product</i>
Dym, Little & Orwin [31]	<i>things a designed device or system is supposed to do</i>
Hubka & Eder [30]	<i>“internal task” of a TS [technical system]</i>
Nagel et al. [112]	<i>A function is an operation by a device or artifact on a flow of material, energy, or signal passing through the device or artifact</i>
Otto & Wood [28]	<i>An abstract formulation of the task that is to be accomplished and is independent of any particular solution (physical system) that is employed to achieve the desired result</i>
Pahl & Beitz [18]	<i>the intended input/output relationship of a system whose purpose is to perform a task</i>
Stone & Wood [109]	<i>description of an operation to be performed by a device or artifact, expressed as the active verb of the sub-function</i>
Ullman [29]	<i>description of what the object does</i>
Ulrich & Eppinger [32]	<i>description of what a product does</i>

2. Literature Background

A function model can be defined as a description of a system, a product, or a process in terms of elementary functions or subfunctions that are required to achieve its overall function, general goal, or purpose [113,114]. The function model is created through function modelling, an activity of developing models of products, processes, objects, devices, or systems based on their functionalities [114]. The function model is a high-level description of what a product must do independent of a product form [29]. The abstract nature of a function model provides an independent view of a product that facilitates the search for a given design problem and ease analysis and management of the design throughout different design tasks and phases of the design process. The function model also facilitates communication among designers and engineers from various domains, supports a shared understanding of product function and provides a way to use computational reasoning in the design process [114].

The function model can be represented in many ways. Among others, some forms of function model representation are: the Black Box model, Function List, Function Tree, and Function Structure. The Black Box model is a function model through which an overall product function is represented, together with the input and output flows of the system. It is used for understanding the way the product interacts with the environment [18,28,31] but does not provide any information on the internal functionalities of the product. Another simple function model is a Function List, where all product functions are simply listed or enumerated [31]. This type of function model provides a simple overview of all basic product functions or subfunctions but does not provide any information on how the basic functions are interrelated. Both the Black Box model and Function List model only provide the basic information about product functionality and thus are often used as a starting point in a function modelling process as an intermediate representation before more information reach function model is created.

Function Tree is one such model that provides a hierarchical overview of product subfunctions. Here subfunctions are hierarchically organised in a tree, where each branch represents a collection of similar subfunctions. The function tree is usually created through a bottom-up approach and is helpful for functional analysis of existing products through Subtract and Operate technique [28].

On the other hand, Function Structure is a graphical representation of the function model where the subfunctions of a product are arranged in a diagram like structure and connected with flows on which the functions operate [18]. The Function Structure provides an overview of the entire system and the interrelations between product subfunctions. The function chains show the linearity in performing subfunctions and show which subfunctions can be conducted parallelly; thus, they are a helpful tool in establishing product architecture.

Figure 2.6 shows the four different function models described above on an example of a screwdriver. The screwdriver is a simple manual tool powered by human energy, used for tightening and loosening the screws. All four function models describe the same product, but the level of information they provide varies significantly. The Black Box model shows the input and output flows of the screwdriver and its overall function but does not tell us anything about a screwdriver's internal functionalities. Function List shows the basic functions of a screwdriver but does not provide any information on how these functions are related or how the screwdriver interacts with the environment. Function Tree improves this by providing the hierarchical structure of functions. Finally, Function Structure provides the most information about the functionality of a screwdriver, as it shows the internal subfunctions, their interaction through flows and arrangement through parallel or sequential, functional relationships, as well as the interaction between the modelled system and the environment.

While all four models have different strengths and weaknesses and are used for various design tasks, Function Structure is a common way of function representation due to the versatility of the information it provides and its suitability for various design tasks. Hence, the following section comprehensively describes function structure and how it is created.

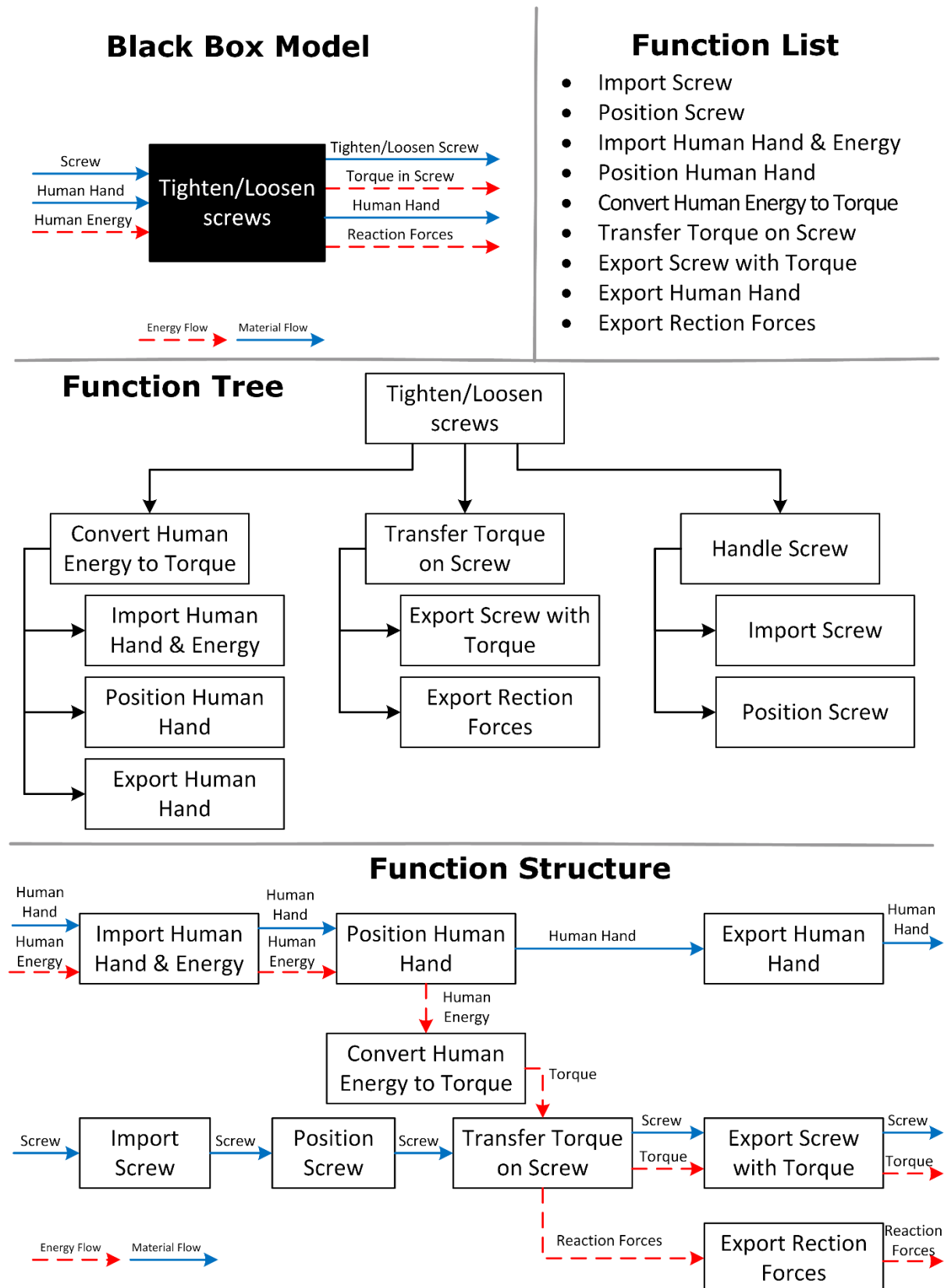

Figure 2.6 Four function models of a screwdriver

| 2.3.2 Function structure

As stated previously, the Function Structure is a graphical representation of a function model in the form of a block diagram, in which each block represents a subfunction of a product, and blocks are connected with the flows of energy, material and signal [18,28]. In the function structure, the overall function of a product is expressed through a solution-neutral relationship between inputs and outputs [18]. A function structure should include working functions (means to fulfil the purpose), assisting functions (allow working functions to fulfil their task), and receptor and effector functions (functions that provide connections across the boundary) at the system boundaries [115].

Every Function Structure consists of a few elements. The first element is a function block, in which the subfunction of a product is stated. The usual notion of a function is in a verb-object format. The individual function blocks are related through connectors (i.e., arrows) representing the flows. As there are three types of flows, each flow is expressed with a different graphical representation (colour, line thickness, line style). Furthermore, the head end of an arrow indicates the input flow, while the tail end indicates the output flow from the function block. Usually, the input flows enter the function block on the left or top side, while output flows exit on the right or bottom. Finally, Function Structure must have a clearly stated boundary of a system. This can be noted with the line encircling the subfunctions of a product [18] or with the nodes that represent the environment [116]. All subfunctions of a product must be inside the system boundaries. Only flows that enable the interaction of a system with the environment can cross the system boundary or are connected with the environment nodes.

Function Structure is created through a technique called functional decomposition. Hubka & Eder [115] talk about two approaches to creating a function structure, one based on a “black box” from which the functions and their relationships are synthesized, and the other based on abstraction of an existing structure and analytical approach for redesigning existing products. Whatever approach is followed in functional decomposition, the complex overall function of a product is broken down into subfunctions of lower complexity. The aim of this process is to find subfunctions that will enable the search for a partial solution and to combine these subfunctions into a Function Structure as a simple and unambiguous graphical representation of a product function model [18].

The functional decomposition starts with determining the overall product function, the input and output flows. The Black Box model is thus often used as a starting point for functional decomposition, as it provides the overview of the overall function product and its interaction with the environment. The next step is to find the subfunctions. If the Function Structure is

2. Literature Background

being made for an existing product, it is recommendable to create a Function List through tear-down and reverse engineering techniques [31]. The requirement list can also be a good starting point for finding the product's subfunctions [18].

To start forming the function structure, it is practical first to determine the main flow and the subfunctions that perform on it to form a temporary basic function structure [18] (Figure 2.7). This is then followed by establishing auxiliary flows and subfunctions associated with them. When all flows and subfunctions are identified and written in Function Structure, their relations need to be established. Finally, a comparison with the Black Box model is made to ensure no input or output flow is forgotten. The conservation of energy and material across the system and each subfunction must be checked [18].

Initial function structure

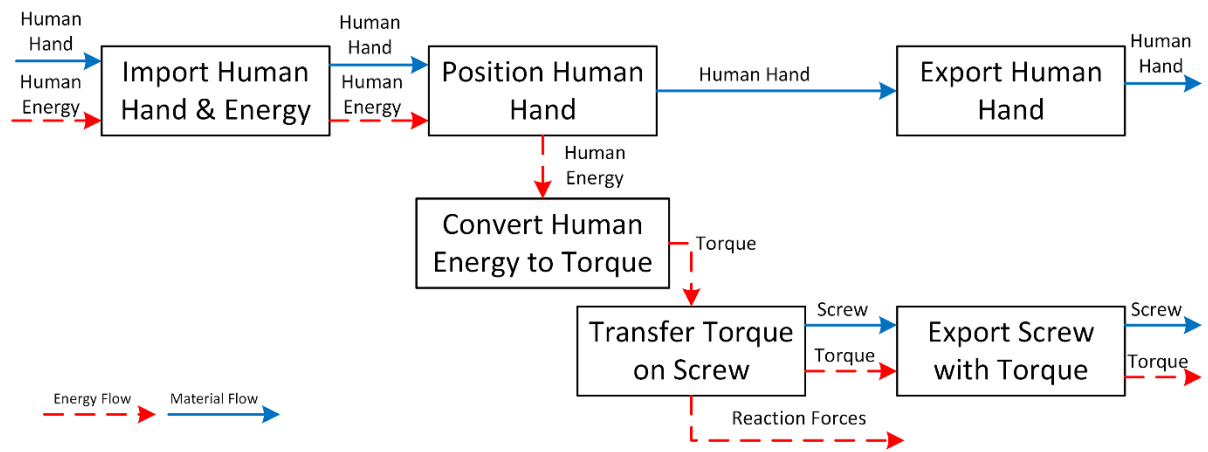

Complete function structure

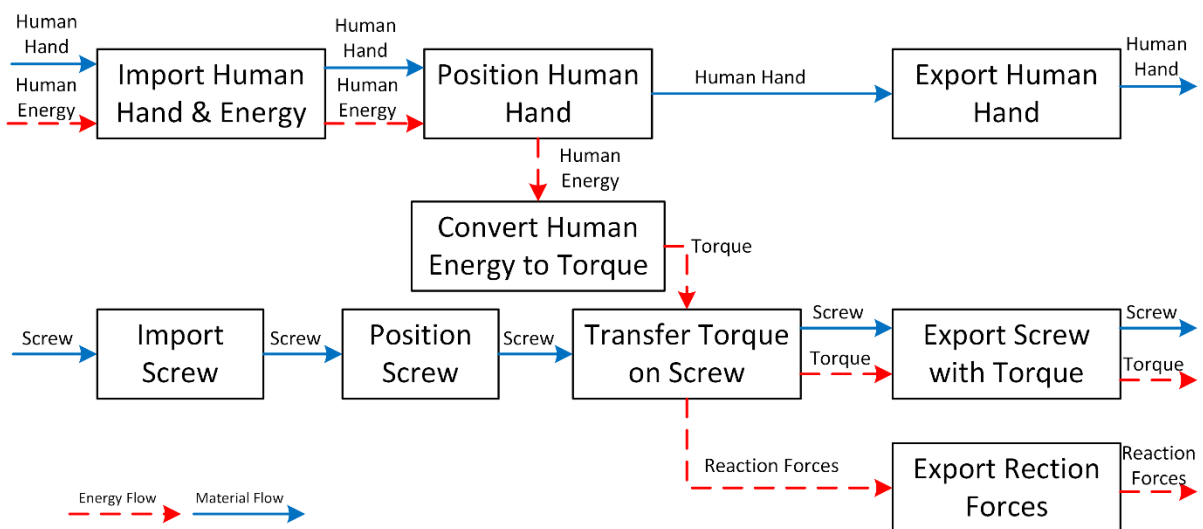

Figure 2.7 Process of creating Function Structure

| 2.3.3 Critique of function models

Function models and functional modelling are helpful tools in the design process. However, they have their limitations that need to be addressed. One of the most common critiques of function models, especially their graphical representation, is the lack of unique representation [109]. The issue can be split into two problems: (i) the unambiguity of how to define a function of a product to describe its meaning with a common understanding, and (ii) how to arrange and connect functions in a function model in a consistent manner.

While the function models, including function structure, are often part of prescribed design processes and activities in engineering design and their layout and way of representation are defined and known, the way how a function and flow inside the function structure should be expressed is arbitrary [52]. Often, designers use their own words to define functions and flows in a function model; hence they understand the intended meaning and reasoning behind such a model [117]. However, the use of such a function model is limited, and it is usually used only inside the team that created it. The lack of common understanding of what a function model represents limits the possibilities of sharing it between design teams, design projects and design domains. Furthermore, it limits the use of function models in automatic and semi-automatic computational activities. Therefore, the first step in achieving the unique representation of function models is to have a controlled vocabulary of functions and flows [118]. To tackle this problem, several vocabularies for function modelling have been proposed over the years and are described in Section 2.3.4.

The second issue is related to the graphical representation of the functions models and is mainly related to the representation of Function Structures. While uniform vocabularies solved the issue of defining individual functions, the challenge of how to arrange the functions in the function model remains. The representation of flows and function blocks in a consistent and formal manner is essential for interpreting function models by human designers, but more importantly, by computer tools to enable computational reasoning and semi-automatization and automatization of design tasks. Hence, prescriptive rules and guidance for creating function structures are needed.

| 2.3.4 Vocabularies for function modelling

Probably the first vocabulary of functions was developed by Collins et al. in 1976 [119]. The research investigated the failures of helicopters, and to retrieve and store the information on causes of failure systematically, they developed the list of 105 so-called elemental mechanical functions. Each function was defined through one keyword and an optional antecedent adjective

2. Literature Background

(e.g., *Supporting, Attaching, Liquid Constraining, Motion Reducing*, etc.). While limited only to functions of one product, the list showed the possibility of using the general description of functions to achieve a common way of function representation.

Pahl & Beitz [18] used a general description of functions through verb-object notation. In this format, a verb describes an action of a product, i.e., function, and an object is a flow on which the function operates. This notation de facto became the standard format for describing functions in many vocabularies and function modelling approaches. Besides the format, Pahl & Beitz provided a list of five general types of functions (*Change, Vary, Connect, Channel, Store*) and three types of flows (*Material, Energy, Signal*). However, these general types of functions only covered the high-level description of functions, but the designers still had to define their own functions on a lower level of abstraction.

Similarly, Hundal [120] defined six primary categories of basic functions (*Channel, Store/Supply, Connect, Branch, Change Magnitude, Convert*). However, Hundal also defines the secondary level of functions called physical functions. Terms on this level provide a description of functions on the lower level of abstraction. For example, the basic function *Channel* is divided into *Transmit, Transport, Move, and Stop*. Each physical function is defined with input and output flow. For example, for physical function *move*, possible input and output flow is *material*, while for function *transmit* possible flows are *energy* and *signal*. Those three are also the only three types of flows in this taxonomy.

Little et al. [121], in their method for mapping product functions with customer needs, required a common basis for comparing products. By analysing household consumer products, they developed a consistent vocabulary made of 31 basic functions categorised in 8 function classes (*Channel, Store/Supply, Connect, Branch, Control Magnitude, Convert, Support, Signal*), and 27 common flows categorised in three types (*Material, Energy, Signals*). Continuing this effort, Stone et al. [109] developed a set of functions and flows called Functional Basis. The terms were further refined and categorised on three levels of hierarchy, and for each function and flow on all levels, a formal definition was provided. The intention of the vocabulary, according to the authors, is to be used for functional modelling regardless of the specific technique applied, with the only requirement to maintain the expression of function as a verb-object pair. Similarly, Szykman et al. [122] developed a generic taxonomy of engineering functions and flows with a hierarchical classification of terms for associating various knowledge entities in the product knowledge representation.

Due to many similarities between the last two vocabularies, Hirtz et al. [118] combined them into one coherent vocabulary, also called the Functional Basis. In the Functional Basis, terms

for defining function and flows are categorised on three levels, primary classes (highest level), secondary level and tertiary level (lowest level). For each term, a short definition and explanation are provided, but also each function and flow have correspondents that map synonyms that are not included in the vocabulary. To date, the Functional Basis has seen wide application in many functional approaches, and it is the most used vocabulary of function and flows [123]. The vocabularies of Pahl & Beitz [18], Hundal [120], and Functional Basis [118] are presented in Table 2.3.

Table 2.3 Three function modelling vocabularies (function terms only)

Pahl & Beitz [18]	Hundal [120]	Functional Basis [118]
Change	Channel	Branch
Vary	transmit, transport,	Separate Divide, Extract,
Connect	move, stop	Remove
Channel	Store/Supply	Distribute
Store	store, supply	Channel
	Connect	Import
	connect, compare, mark,	Export
	valve, switch, pack, mix,	Transfer Transport, Transmit
	add, subtract, multiply,	Guide Translate, Rotate,
	divide, AND, OR	Allow DOF
	Branch	Connect
	Cut, Branch, Count,	Couple Join, Link
	Display, Separate	Mix
	Change Magnitude	Control Magnitude
	Process, crush, form,	Actuate
	coalesce, change	Regulate Increase, Decrease
	Convert	Change Increment, Decrement,
	liquify, solidify, evaporate,	Shape, Condition
	condense, integrate,	Stop Prevent, Inhibit
	differentiate, NOT,	Convert
	display, sense, convert	Provision
		Store Contain, Collect
		Supply
		Signal
		Sense Detect, Measure
		Indicate Track, Display
		Process
		Support
		Stabilize
		Secure
		Position

2. Literature Background

Kurfman et al. [124] carried out an experimental validation of Functional Bases. They concluded that the use of the Functional Basis improves the creation of repeatable function models created by various designers, it improves the clarity in communication among the designers, leads designers towards the creation of a unique function model for the given design problem, but does not support the repeatability of flows thus the identical models are not achieved. Ahmed and Wallace [125] also evaluated the Functional Basis and compared it with Szykeman's taxonomy. They concluded that the Functional Basis significantly improves the expressiveness of function models created with it. Finally, Caldwell et al. [126] analysed the design repository of 130 function models of consumer products created with the Functional Basis. They observed the inconsistent use of terms in function models, where besides the use of Functional Basis terms, often the model contained a term outside the prescribed vocabulary, especially additional qualifiers for describing the flows. Furthermore, by comparing the functional models, they concluded that the secondary level of terms is the most practical level for function modelling, as it provides optimum between abstraction and detailed description of product functions.

| 2.3.5 Rules for creating function structures

Function structure is a graphical representation of a function model, where each subfunction of a product is connected with others through flows, as defined by Pahl & Beitz [18]. In function structure, each subfunction of a product is represented as a single block, and blocks are connected with flows where each type of flow is noted with a different type of connector. All subfunctions of a product are inside the system boundaries, and flows crossing the boundaries are the ones through which a product interacts with the environment or user. For arranging the subfunction and flows in a function structure, Pahl & Beitz use only one basic rule - the conservation rule. The rule states that every flow of energy or material entering the system or a subfunction must exit the system or a function, the input flows can join, separate, or change the form at the output, but no overall loss of energy or material can occur, the sum of input flows must match the sum of output flows. Following the conservation rule only ensures the consistency of the flows and limits the impossible transformation from the physic point of view. However, it does not provide guidance on the relative arrangement of function blocks.

To achieve a consistent representation of function blocks inside the function structure, Sridharan & Campbell [127] developed a set of 69 grammar rules for the semi-automated creation of function structures. They observed a set of products and extracted characteristic patterns of function block arrangements that make a complete function structure. To create a

function structure, one starts with system input and output flows and the main subfunction of a product. Then the grammar rules are applied using so-called action centres for applying the rules. Once the rule is applied, the predefined syntax consisting of one or a few function blocks is added, and the application of rules continues until no action centres are left. The approach enabled the creation of function structures with consistent representation and arrangement of function blocks. Still, it is limited only to energy and material flows and is only suitable for function modelling of electromechanical consumer and household products. The approach was expanded by Nagel et al. [112] with the extension of the approach to modelling signal flows. They analysed a set of electromechanical products and derived 12 grammar rules for modelling signal flows. Their rules complement the original 69 rules and provide a uniform understanding and consistent archival of signal information. Both approaches use the Functional Basis for defining function blocks and flows in their syntax.

Bohm & Stone [128] developed a set of rules for the semi-automated creation of function models in their “Form follows Form” approach. They analysed a set of components to identify inputs and output flows for individual functions those components perform. From this analysis, they developed two sets of rules, so-called stage one and stage two grammar rules. Stage one rules are based on the secondary level of Functional Basis and define the possible input and output flows for each individual function, thus increasing the formal expressiveness of the Functional Basis. Stage two rules are intended for the post-processing of the function model to increase its accuracy. The rules define the primary/carrier flow relations and address the function model instances where functions conflict with one another.

Sen et al. [116,129,130] approach the creation of function models from a physics-based reasoning point of view and is probably the most comprehensive and rigorous set of functional modelling rules to date. Their conservation-based approach is focused on qualitative and quantitative reasoning and analysis to achieve function structure graphs in a consistent and grammatically controlled manner. The developed set of rules consists of hierarchical vocabulary based on the Functional Basis and 33 grammar rules that allow and constrain modelling constructs and, through it, ensure the consistency of a function model. The approach requires high-level abstract thinking about functions and an early commitment to types of flows in a function model and reasoning regarding energy and material losses that might be irrelevant in the early stages of the product development process. Furthermore, while the rules and vocabulary ensure the consistency of created function structures, the significant number of rules and constructs to be checked make the approach cumbersome for manual function modelling;

thus, the authors developed the “*ConMod*” application for modelling and reasoning of function structures.

Similarly to Sen’s physics-based reasoning, Mohammed & Shammari [131] proposed the use of a *Procedural Rule-based Functional Modeling Structure* (PRFS) algorithm for the creation of consistent function structures. The model is also based on the Functional Basis vocabulary; however, it is only used for defining functions, while self-defined terms are allowed for flows. The algorithm consists of four sets of rules for creating function structures: (i) input/output grammar rules, (ii) functional changing rules, (iii) replacement rules, and (iv) meta-rules for functional structures. The rules restrict the function block combinations in function modelling and aid in creating function structures with consistent representation.

On the other hand, few authors focused on the representation of flows in function structures and their interaction inside the system. Nagel et al. [132] and Bohm & Nagel [133] defined the concept and relations of a carrier flow as a flow with the essential purpose of carrying or transporting another flow through the system (e.g., the flow of gas carries the flow of pneumatic energy). They established the basic rules for modelling such flows and mapped the possible primary/carrier flow relations combinations. Wang and Jin [134] focused on functional events and defined three types of flows interaction with the function block. A providing flow that enters the function block and on which the function operates, the enabling flow that also enters the function block but whose purpose is to enable function operation on the providing flow, and the produced flow as the output flow of a function block. While increasing the complexity of function structure, both approaches provide a means for including additional information about the system inside the function structure.

| 2.4 Function Integration & Function Mapping

The goals of using function models in the design process are to establish product architecture, facilitate the search for design solutions for the given problem, support different analyses of a product or a system and provide a way for its common representation[18,28,29,31,135]. Function structures are often used to establish product architecture, most notably to enable function integration or to support the modularisation of the product [35,136]. Furthermore, the mapping of functions onto something, being that something requirements, user needs, solutions, artefacts, risks, components, or any other entity of interest, have been used to provide the mean of observing different relationships inside the product or a system [18,28,29,31,135]. By mapping different entities on the function model as a neutral form of representation, various connections can be observed and utilised to achieve different goals,

from storing information about previous designs to automating the design activities or analysing the risks in the early stages of the design process. However, while the function modelling is abstract and form-independent, current function-to-form mappings are domain-specific and require domain-specific rules for mapping and applying the mapping relations in the design activities [137].

| 2.4.1 Function Integration

Function integration describes the concurrent implementation of several functions by a single feature, structural element, or part [43]. The goal of function integration is to reduce the number of parts contributing to the design's robustness [35]. Furthermore, Ulrich & Seering [43] state three reasons why function integration can be advantageous. Firstly, designs with integrated functions are often, in most respects, better designs. Secondly, function integration can simplify the design, and thirdly it can be seen as a source of novelty. On the other hand, function integration can have negative effects such as reducing serviceability, recyclability, or increased cost of manufacturing [28]. Therefore, the design decision to pursue function integration is always a balance of advantages and disadvantages.

However, due to its high flexibility and design freedom, the AM often removes disadvantages associated with the manufacturing of integrated designs [138], and designers often look to reduce the number of parts when using AM. The AM-integrated designs can be achieved through part consolidation or function integration [16]. Part consolidation refers to geometric remodelling of design by elimination of connection features, easing assembly operations and reducing the number of parts. On the other hand, function integration requires interpretation of functional requirements and is associated with the conceptual design stage of establishing product function structure.

When AM and its capabilities of part consolidation and function integration are considered, researchers proposed a few DfAM methods, mainly on the assembly level, to achieve integrated designs. Yang et al. proposed a methodology for part consolidation through the redesign process for AM [44]. The methodology aims to reduce the number of parts in an assembly and improve product performance through structure optimisation. It takes functional surfaces established in an “original” conceptual design and proposes new and optimised shapes based on AM capabilities. The approach was later refined in the following “Assembly-Level DfAM methodology”, where the emphasis on the early design phases is greater [16]. The core activities here are functional analysis and function integration. By considering AM possibilities, possible alternative concepts and innovative shapes are proposed. From the functional analysis, new

2. Literature Background

possible functions could be identified, and a decision regarding the integration of functions is made.

Similarly, Sossou et al. [139] proposed the AM-oriented design approach for the redesign of assemblies, where the conceptual design phase is focused on functional analysis to identify functional interfaces and product layout. The redesign is conducted in the context of AM, where AM specificities regarding the manufacturing of assemblies are considered, and new constrained design spaces are defined before defining the geometry of components. Glasschroeder et al. [138] identified three areas to accomplish function integration in AM parts made through the PBF process: mechanical functions regarding motions and force distribution, thermodynamic functions associated with exchange and conversion of energy, and electrical functions related to the integration of conductive lines. Rodrigue and Rivette [140] developed a design methodology for the consolidation and optimisation of products using advantages of shape complexity, material complexity and cost functions. The methodology firstly determines the candidates for consolidation and then applies the method for the optimisation of functions to achieve function integration. Boyard et al. [38] focused on the functional specification of the product and possible AM solutions. In the conceptual design phase, a 3D graph of functions is created to allow the reorganisation of functions spatially to determine the product's architecture through both function integration and modularisation. The graph is compared with existing graphs in the database of AM solutions, enabling reconfiguration of the layout and creation of concepts based on the specificities of AM.

| 2.4.2 Function mapping for design synthesis

One of the applications of function mapping is for design synthesis. In early design phases, function mapping is often used to create product layouts or concepts. The morphological matrix is an example of function mapping to create concepts of a product [18]. In the morphological matrix, designers list the product functions in the first column and then populate the matrix with one or more partial solutions for each function. By combining different partial solutions, concepts of a product are generated. While a valuable tool in brainstorming potential design solutions and combinations of solutions for solving product functions, the morphological matrix rely on the designer to populate partial solutions and their synthesis. Strawbridge et al. [141] adopted the morphological matrix in their concept generation technique. However, they firstly develop a function-component matrix, populated through empirical analysis of consumer products, that maps functions and components used as solutions. This matrix is used as input for the concept generator and is multiplied with a filler matrix, a matrix representation of a function model of

a product being designed, to create a morphological matrix, thus providing solutions from previous designs. Bryant et al. [142] follow this approach and use an existing design repository to populate the function-component matrix, thus creating a knowledge base used for the automated concept generation tool.

Kota & Chiou [143] developed a matrix-based approach for the conceptual design of mechanisms. In this approach, functional building blocks are mapped on schematic building blocks that perform specific kinematic functions. The new design is then synthesised using a motion transformation matrix and a sequence of constraining matrices from which possible mechanism configurations are generated by matrix decomposition. On the other hand, Nix et al. [144] created a Functional Basis – TRIZ Correlation Matrix. The matrix maps the functions from the secondary level of Functional Basis [118] with TRIZ design principles for inventive solutions [145]. The conducted mapping aids designers in a systematic function-based design approach to use the TRIZ principles for solving functions.

The above-described approaches are based on matrix-manipulation algorithms for mapping product functions onto the design solutions retrieved through reverse engineering of the existing pool of products. On the other hand, Kurtoglu & Campbell [53,146] developed a graph-grammar method for concept generation through the mapping of product functions. Their approach is based on mapping function structures with components that could be used to solve an individual function or a function block. The method is based on the application of grammar rules, where once the rule is detected in a function structure, the individual function or function block is replaced with the component. By replacing all functions with components, a configuration flow graph is created. The graph represents a possible configuration of the product and is used for generating concepts of a product.

Besides matrix and graphical approaches, ontologies are also used for mapping product functions. Chen et al. [147] created an ontology-based method for deriving innovative products. The method uses an ontology for mapping functions onto behaviour and then behaviour on the structure. Roy et al. [137] proposed a method for design synthesis that utilises mapping from the functional requirements to artefacts through multi-stage optimisation to drive the evolution of the product. The core of the method is the formalisation of function, behaviour, and artefact representation. The uniform representation facilitates the mapping between functions and artefacts. Tang et al. [148] proposed the use of functional reverse engineering for secondary innovation. Their approach uses functional reverse engineering to create an initial function structure through structure-to-function mapping. By conducting the mapping between function and structure, the functions structure of a product is re-engineered and improved to find new

and innovative solutions for the overall product functionality. Zhang et al. [149] developed a hierarchical framework based on the hybrid mapping of functions for supporting the conceptual design phase. The framework uses four design domains (function, working principle, behaviour, and structure) with 15 mapping relations between the domains. Mappings are based on the experiential designer's knowledge and extend the information about the products by mapping functions. The computational tool enables exploration of design space expanded with the multiple mappings and suggests designer possible innovative solutions for the design problem.

| 2.4.3 Function mapping for design evaluation

Alongside the mapping for design synthesis, the mapping of functions is also used to evaluate the design. This kind of design evaluation through function mapping is highly beneficial in early design phases when the product's form is unknown.

Tumer and Stone [150] used mapping of component functions with failure modes to identify potential failure modes in early design stages based on the functional model of the new component. The method utilises a link between failure modes and functionality of components and provides an analytic tool for making decisions during the design process based on functional similarities to avoid potential failure modes. Building on this approach, Grantham et al. [151] proposed the use of the Function-Failure Design Method. The method is based on a matrix approach for mapping functions with components for a new design. The matrix is then multiplied with a component-failure mode matrix containing information on the component's historical failures. The resulting function-failure mode represents the mapping of functions on the failures and shows the likelihood of risks associated with the potential design.

Kalyanasundaram & Lewis [36] proposed a matrix approach based on mapping functions with components for two existing products. The central matrix used is the Function Sharing Matrix, whose goal is to enable mapping for the analysis of function-component relations and their role in developing reconfigurable product architecture. McAdams et al. [152,153] developed a Design-By-Analogy method based on the mapping of product functions through customer needs. In the approach set of functions is mapped with the existing pool of products through a quantitative measure of calculated product importance. Then, using the normalisation process, one can compare the new product's functions with the existing products based on the product's functional similarity. This allows the evaluation of existing design solutions and the use of analogy in design.

| 2.5 Research Gap

The AM, as it can be seen from Section 2.1, is a unique manufacturing technology that comes in various forms and brings an amazing set of design possibilities but also some restrictions as well [4,5]. To utilise the AM possibilities, new sources of AMK and new design support methods and tools for DfAM are needed, and the research community is already responding by developing various DfAM approaches (Section 2.2). However, there is currently no function based DfAM method for the early design phases. Following the motivation of the research to develop the DfAM methodology for early design phases and the literature review focused on DfAM, AMK, function modelling and function mapping, research gaps for the development of the proposed methodology are identified. The research gaps are addressed with the following four research questions (RQ).

| 2.5.1 RQ1

To provide a systematic approach to the design process, the proposed methodology starts with the function modelling of an AM product and its representation through a function structure diagram. Section 2.3 describes the current state-of-the-art in function modelling and function model representation. The literature review emphasised the need for the representation of functions through predefined vocabulary [118,120] while using formal rules for creating function structures [112,127,129]. The use of function vocabulary and rules forms the way how product functions are expressed and how function models, including function structures, are created. This ensures function models have a common representation and understanding essential for developing methods and tools that can be universally applied.

However, while claiming a universal application across the domains, the current approaches in function modelling are mainly developed through the analysis of electro-mechanical consumer products [118,121,146]. The functional models of these products are characterised by the emphasis on the flow of electrical energy and manipulation of signal flows that are used, in combination with other types of flows, to describe the functionality of the product [126]. On the other hand, current AM designs emphasise the interaction with human operators, flow of mechanical energy, and flow of materials. This raises the question of whether hitherto developed approaches for function modelling are suitable for function modelling of AM products. Therefore, to address this research gap first RQ is formulated:

***RQ1:** What are the distinguished features of function models of AM products, and how should the function structures of AM products be expressed?*

2. Literature Background

The first RQ investigates what are the distinguished features of AM products function models in terms of the characteristic functions and flows found in AM products. Furthermore, it investigates how the function structures of AM products need to be expressed to support the proposed methodology for mapping product functions. To address RQ1, a function modelling method for creating function structures through predefined Function Classes (FCs) is proposed in Section 4.2.

2.5.2 RQ2

To create a new design, specific design knowledge is required for a given context in which design is created, manufactured, and used. This knowledge can come from various sources, such as the designer's own intuition and experience, previous designs, or formal sources of design knowledge like design catalogues or repositories [28,32]. While for many conventional manufacturing technologies, what is context-specific design knowledge and its sources are well known, for the context of DfAM, AMK and its sources are not fully established due to the novelty of AM.

The review in Section 2.2 showed different types of AMK are used across the area of DfAM. Hitherto, AMK is stored in design feature databases [46], wiki repositories [74], different types of cards [14,104–106], design principles [48,103], design heuristics [47,100], design rules and many more. Each of those sources formalises AMK for the specific context of the design method or tool in which it is used. Some sources provide AMK needed for conceptualisation, while others are focused on detail design and manufacturability.

Currently, the two most comprehensive forms and sources of AMK for early design phases are design heuristics and design principles [14,48,104]. Heuristics are a form of design knowledge that provides a design process direction based on intuition and tacit knowledge. At the same time, principles are fundamental rules that increase the chances of finding a successful solution [49]. Hence, heuristics for AM are abstract in their form and do not provide direct relation with functions. On the other hand, while less abstract, design principles cover a wider area of the design process. Due to a lower level of abstraction when compared to heuristics, principles are more suitable for defining relations between AMK and functions [50]. Hence, several authors have already proposed different categorisations of AMK based on the partial functions they are solving [37,39,40,42], but none of the approaches is fully developed or publicly available. To address the described research gap, a second RQ is formulated:

***RQ2:** What are the design principles based on the capabilities and limitations of additive manufacturing?*

The second RQ aims to review and consolidate the different sources of AMK for early design phases and, through empirical research, investigate the AMK stored in existing AM products. To address the RQ, a comprehensive list of AM DPs is derived and presented in Section 4.3.2.

2.5.3 RQ3

The paradigm form-follows-function [29] is often used in systematic design processes. The relations between the functions and the form define the product's functionality, look, and performance. Therefore, understanding these relations is essential for understanding the design and design process. Furthermore, the relations between the functions and the form are implicitly embedded in the product itself [53] and can be extracted and formalised [51]. Consequently, by observing these relations, one can better understand the previous designs for the given design context and apply this design knowledge in new product development.

The literature review (Section 2.4) showed different ways how the function-form relations are formalised and used across the engineering design for different contexts and various design activities. Furthermore, Section 2.2 revealed the function-form relations inside the DfAM were already a subject of investigation [37,39,40]. However, none of the three hitherto proposed approaches discloses the full extent of relations between product functions and AM based forms. Moreover, while there are multiple ways for formalising relations between functions and forms in different domains (e.g., matrix-based, graphical, and ontological approaches reviewed in Section 2.4), this was not a point of interest in DfAM so far. Hence the third RQ addresses this research gap and is formulated as:

***RQ3:** What are the relations between AM design principles and product functions in existing AM designs, and how can they be formalised in the form of mapping rules?*

The third RQ should, through empirical investigation, identify relations between functions and AM forms. Furthermore, following the recommendations from existing literature sources, the observed relations are formalised to enable their application in new product development. The third RQ is addressed through the list of function mapping rules proposed in Section 4.3.1.

| 2.5.4 RQ4

Once the first three RQs are addressed and adequate methods and tools developed, they are combined into an overall methodology that will enable utilisation of the AM possibilities during the early design phases of AM oriented design process and enable function integration and embodiment of AM based solutions. Thus, the fourth RQ is:

***RQ4:** How can mapping rules be applied to enable function integration and embodiment of design solutions?*

The fourth RQ investigates the framework for function modelling of AM products, mapping of product functions and AM DPs, and application of mapping rules needed for the conceptualisation of future AM products. The RQ is addressed through the framework of the proposed Mapping Methodology (Section 4.1), which is supported by the computational prototype framework (Chapter 5).

3

Analysis of AM Products & Parts

Chapter 3 is a part of Descriptive Study I and presents an empirical study of the thesis. The study is conducted to understand the functions, forms, and their relations in existing AM products and parts. The gathered insights are the foundation for the development of the Mapping Methodology. Firstly, the outline of the empirical research with the rationale of the research and its phases are described. This is followed by a description of the gathered products and parts. Finally, three conducted analyses are presented, the analysis of functions in AM products, analysis of AM forms, and analysis of form-to-function relations. The results of the analyses are described in the following chapter.

3.1 Empirical Study Outline

Every product can be considered an archive of design knowledge. When the product was initially designed, a designer or design team had to solve a design problem they were facing. To accomplish the task, they used their own design knowledge, experience, and intuition, investigated examples of best practices, developed the product through a trial-and-error approach, or used some other research and development approach to find an optimal solution. In doing so, they incorporated accumulated design knowledge into the product itself. Hence, the design knowledge about the product functions, forms, and relations between the two are embedded into the products and implicitly available and a methodology can be developed that will, through a systematic examination of products, enable the extraction of the accumulated design knowledge utilised during the design process of creating the product [49,53]. The premise used in the empirical study is that examples of “good” AM products embrace innovative forms based on AM potentials and incorporate the best practices used for solving the functions of a product. The term “AM products” used here refers to products and assemblies entirely made with AM and to parts and components that are incorporated in an assembly with other components not necessarily made with AM.

Similar premises were used before for the derivation of design knowledge in multiple domains [154,155], including the domain of AM [47]. As each product has a set of functions it needs to fulfil, one can observe how these functions are solved and what are the used AM forms in doing so. In other words, one can conduct form-to-function mapping. The results of analysis and capture of form-to-function mapping can be reversed and used in new product development

for the function-to-form mapping approach and search for design solutions for each function or a block of functions[51].

The inductive research approach used to develop the methodology for mapping product functions with AM Design Principles (DPs) follows this paradigm. The inductive research process is often used in design research to extract design knowledge by studying existing products, best practices, and patents or by observing the designers and their design processes [49,154,156]. Hence, an inductive approach is adopted based on the observation and analysis of existing AM products, their functions, and key features. It includes three phases: collecting data, analysing data to extract the patterns, and forming a theory based on the identified patterns [49].

The empirical study addresses the first three RQs, how AM products' functionality can be expressed (RQ1), what are the AM DPs (RQ2), and what are the relations between product functions and AM DPs (RQ3). For each RQ, a separate observation is conducted. However, as the RQs are interrelated, the observations are conducted on the same sample of products in a highly iterative manner. Therefore, the empirical research approach is made of four stages:

- 1) data gathering,
- 2) study of functions in AM products & parts,
- 3) study of AM forms,
- 4) study of AM form-to-function relations.

The first stage of the empirical research solely corresponds to the first phase of the inductive approach, while the other three parts are made of two stages corresponding to the data analysis and theory building phases for each respective RQ (Figure 3.1). The phases and stages of the research are interrelated, and their overall output is used to formulate the overall mapping methodology. Each part of the empirical research has a separate protocol that defines the details of conducted analysis. The protocols and analysis are described in corresponding sections of the chapter. The results of the empirical study are sets of function modelling rules, Function Classes (FCs), AM DPs, and Mapping Rules (MRs) that are incorporated into the overall Mapping Methodology and presented in Chapter 4.

The empirical study starts with a search for AM designs to form a pool of AM products needed for the three analyses. The first analysis (Section 3.3) investigates AM products' functions. It is based on reverse engineering of gathered AM products to understand each AM product's functionality and form, and to create their function structures. With cross-comparison of function structures, conclusions regarding how function models of AM products can be expressed are drawn. The created function structures are used for facilitating the other two

conducted analyses. The AM form study (Section 3.4) observed products from the data pool to find forms and AM features used for solving product functions. By finding patterns among the embodied solutions, design knowledge about AM is extracted and formalised in the form of AM DPs (Section 4.3.2). Finally, in the last stage of the empirical study (Section 3.5), function structures and AM DPs are used to perform the form-to-function mapping. With the consolidation of performed mapping, relations between forms and functions can be generalised. The generalised form-to-function relations are then reversed and formalised in a set of MRs (Section 4.3.1) that enable function-to-form mapping in new product development (Section 4.3).

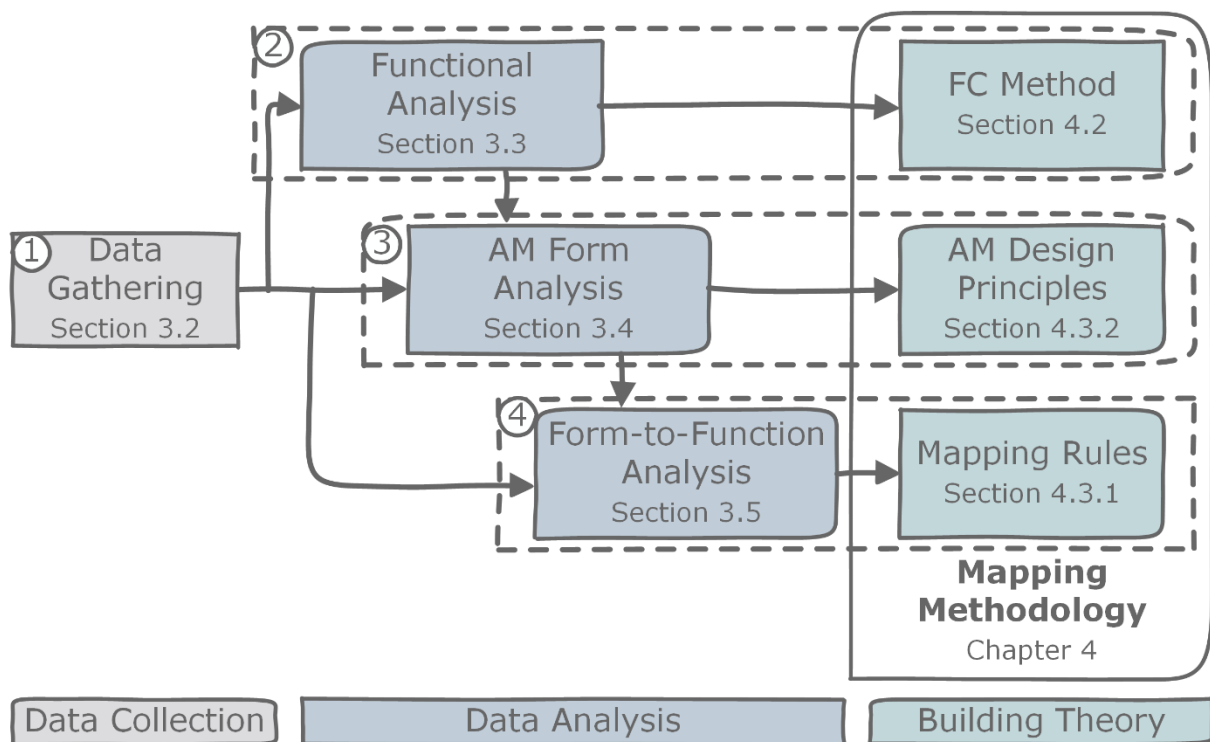

Figure 3.1 Overview of Empirical Research

3.2 Data Gathering

To conduct research based on reverse engineering, firstly, the pool of AM products and their related data that will be analysed is established, which corresponds to the data gathering phase of the inductive approach. Then, to gather AM products for the analysis, selection criteria and potential sources of AM products are defined to enable a meaningful search and ensure appropriate records of design knowledge stored in the AM products are gathered. The steps of data gathering are shown in Figure 3.2.

3. Analysis of AM Product & Parts

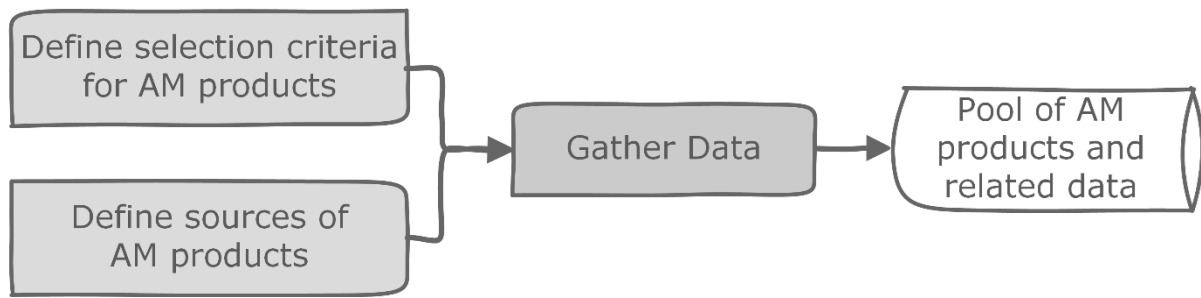

Figure 3.2 Data Gathering Protocol

While analysis of any product can reveal a chunk of knowledge, to have a more meaningful analysis according to the RQs, criteria for the selection of AM products need to be defined. Because the RQs are focused on product functionalities and unique possibilities of AM, selection criteria must include these two requirements. Furthermore, the AM is a rapidly growing area, with the development of new materials, machines, and AM capabilities, and the current status of AM technologies needs to be considered. However, the AM is being developed through both scientific research and commercial research & development, and the state-of-the-art capabilities of AM in those two areas are not necessarily the same. As the research aims to provide design practitioners with a methodology for everyday design activities, methodology based on the possibilities of AM not available through current commercial AM equipment cannot be fully utilised, and selection criteria should reflect this point. Moreover, to conduct the analysis of a product, enough data must be available to have a clear description of the product, its intended functionality, and its AM features. In other words, data must be an appropriate source or stored design knowledge. Taking all the above into account, the following criteria for the selection of AM products are established:

- a product or a part must have features that are solely possible with AM or AM add additional value to the product, its features, or performances;
- a product or a part must be possible to manufacture on the current commercially available AM equipment;
- enough data about a product or a part must be available to conduct necessary analysis (e.g., pictures, description, physical product, or CAD model).

After the criteria are defined, three sources of AM products are identified: (i) commercial products and demo products, (ii) crowdsourced products, (iii) literature sources. Commercial products are a good source of evidence as they show the matured AM capabilities already used for solving functions of products and satisfying user needs. Together with commercial products, demo products of major AM equipment manufacturers provide an overview of current state-of-the-art AM capabilities. However, as their purpose is to show advances in AM capabilities,

careful selection is needed as some of the demo products do not display an overall function clearly, or functionality might be hindered due to the explanatory purpose of the product. The crowdsourced repositories of AM models (e.g., *Thingiverse*², *Thangs*³) provide a great number of designs that are often made through a trial-and-error approach, thus containing empirical knowledge about AM. However, many designs are simply a replication of products originally designed for other manufacturing technologies. Thus, a careful selection of products that show improved functionality or performance using AM must be made. Finally, literature sources are a valuable source of AMK. They usually clearly state how and why some product is designed the way it is, thus enabling objective analysis.

The data gathering started with the initial set of 15 AM products and was gradually expanded in sets of 5 until the results of conducted analyses converged, as explained in Section 3.6. In total, the pool is made of 45 AM products. Figure 3.3 shows the main distribution of AM products by sources and their distribution by domain. Most products are extracted from crowdsourced repositories due to the high volume of examples and accessibility of product information. More than a third of analysed products are commercial and demo products, while literature sources are the source for a quarter of AM products.

Consequently, because crowdsourced repositories are the biggest individual source of AM products, most products are from the domain of consumer goods. However, products from aerospace, mechanical engineering, and medical domains together make up almost half of the pool of AM products. These three domains are significant users of AM [1,7] and AM equipment manufacturers often provide product examples for these domains. The domain labelled as “Other” includes sports equipment, decorative products, scientific equipment, and other domains with fewer than three products or parts in the pool.

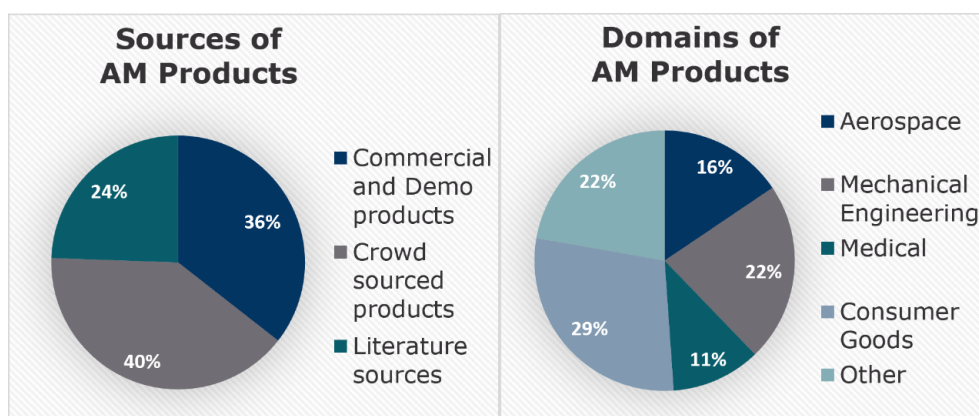

Figure 3.3 Overview of the pool of AM products & parts

² Thingiverse, <https://www.thingiverse.com/>

³ Thangs, <https://thangs.com/>

3.3 Study of AM Products & Parts Functions

This section is based on the submitted paper [157].

The functional analysis is the first conducted study on the pool of gathered AM products. This study is associated with the investigation of the RQ1 – what are the features of AM products function models and how can AM product's functionality be expressed through function structure (Section 2.5.1). The objective of functional analysis is to evaluate existing functional modelling methods and tools in the context of DfAM, identify key functions and flows in AM products, draw conclusions on how function models of AM products should be represented, and categorise the gathered knowledge to enable the creation of AM product's function structures as a part of the Mapping Methodology. The study covers the data analysis and theory building phases of the overall empirical research associated with the investigation of RQ1 (Figure 3.1). The analysis is divided into two parts, the study of existing function modelling approaches through initial function modelling and the development of the function modelling approach (FC Method) for AM products through consolidation of function structures.

3.3.1 Initial Function Modelling

The study of existing function modelling approaches evaluates their suitability for creating function structures of AM products in a formal, consistent, and repeatable manner. It is made of four steps, shown in Figure 3.4. The study starts with the literature review on function modelling approaches (Section 2.3) and investigates their capability for consistent and repeatable representation of AM product's functional models through function structures needed for the formalisation of MRs and the mapping process. The literature recommendations are used to create function structures describing the overall product functionality. The function structures are made using elements of different function modelling approaches from the literature [18,112,113,118,127,129,132,134] to evaluate which approach or combinations of approaches is appropriate for representing functions of AM products.

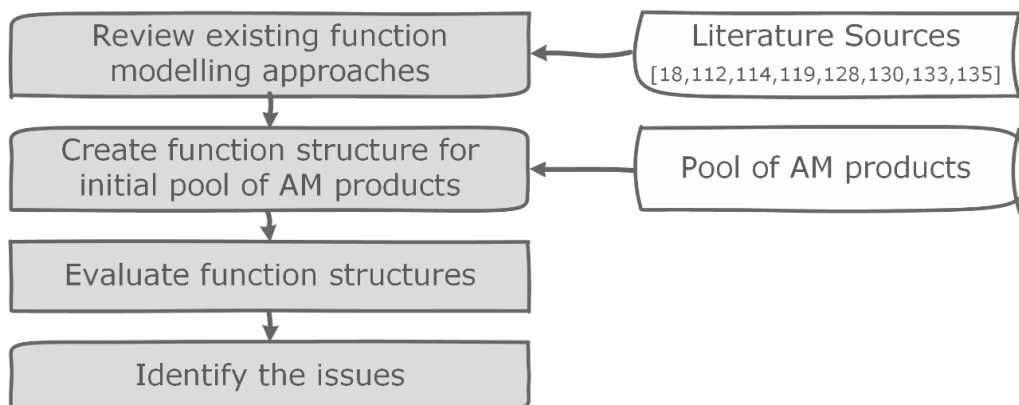

Figure 3.4 Steps of evaluating function modelling approaches in the context of DfAM

The example of crated function structures is shown in Figure 3.5. The four function structures represent the function model of the AM gear with internal channels for cooling [158]. All four function structures contain the same eleven functions, but for every function structure, different approaches from literature are applied to define the functions and arrange them into function chains. For example, the first function structure is based on Pahl & Beitz approach [18], and functions and flows are defined using natural language. Hence for similar functions of bringing flow into the system, three different functions are used – *connect*, *input*, *import*. Similarly, while both solid objects, *shaft* and *gear* are defined using the common terms used in engineering. The function structure is easy to read, and someone with a technical background can easily comprehend the meaning, but its layout is highly dependent on the designer who created it; thus, the repeatability of representation is questionable.

The same logic for function modelling is applied in the second function structure, but the Functional Basis terminology is used for defining functions and flows [118]. Now the functions for bringing flow into the system are defined using the same term – *import*. However, as all levels of Functional Basis are used, the second gear is defined as *solid*, while the shaft is defined as an *object* which is sub-term of solid. The predefined vocabulary enabled consistent use of terminology on a higher level of abstraction, but the use of multiple levels of hierarchy brought an additional ambiguity as it was not clear which level of vocabulary should be used for which purpose. The third function structure addresses this problem as it uses only terms from a secondary level of Function Basis. The secondary level of terms provides the optimum ratio between abstraction and expressiveness [126]. Now repeatability of functions is achieved, but their arrangement in a function chain and overall function structures is still not defined, and consistent representation is not achieved. This is partially addressed by applying the concept of carrier-carried flows [132], providing rules for representing related flows, such as *mechanical energy* that enters the system through the *shaft* (material flow).

The fourth function structure is based on the rules for physics-based reasoning [129]. Here carried flows are stored in the carrier flow, and a list of 33 modelling rules is followed to have a consistent representation of function structure. Furthermore, an analytical approach is used to represent inputs and output flows [134]. This formally defined what are the input, outputs and enabling flows for the given function and their locations for entering a function block.

3. Analysis of AM Product & Parts

Pahl&Beitz

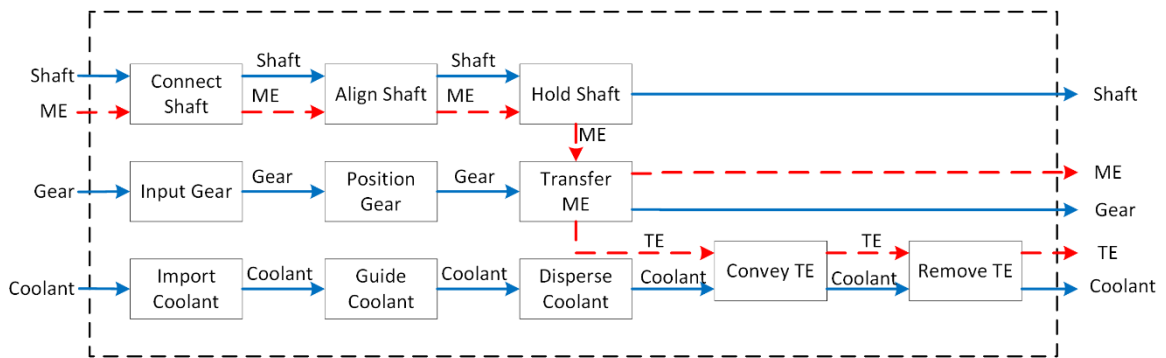

Functional Basis

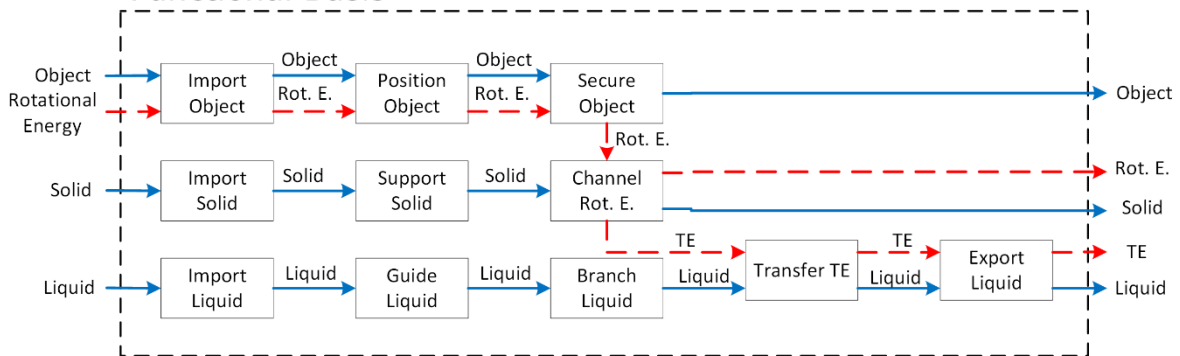

Second Level Functional Basis + Carrier/Carried Rules

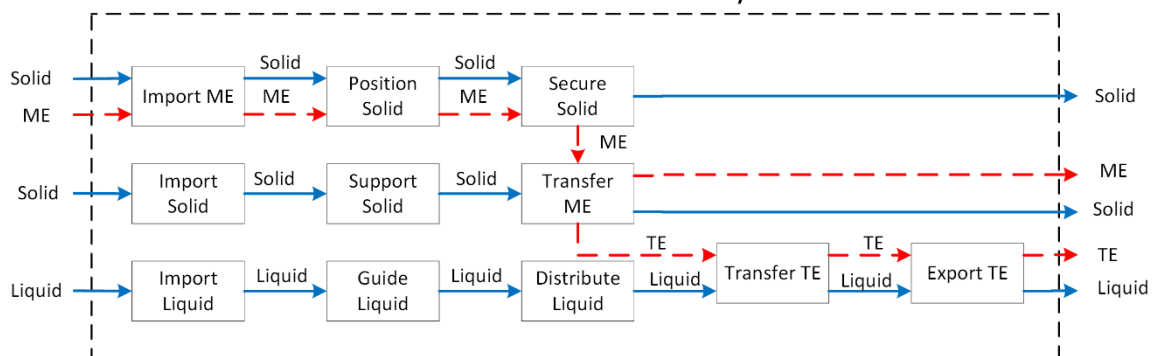

Physics-Based Reasoning + Analytical approach

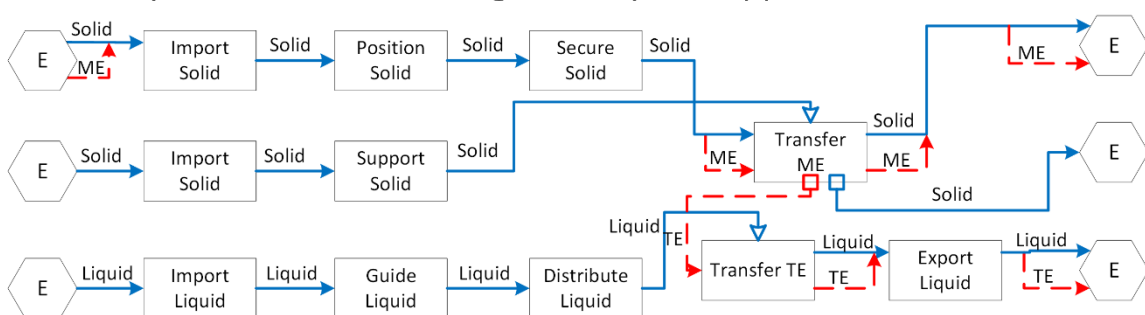

Figure 3.5 Example: Initial function structures of an AM Gear

All four function structures represent the same functionality of an AM gear and are relatively easy to understand. However, one can observe how they differ in representing both the overall

functionality and individual functions. Across the four function structures, uniformity of representation is not achieved, which is necessary for the development of formal MRs and computational approach. This is especially noticeable when these and other function modelling approaches from literature are used across different products to create function structures. By modelling and comparing function structures of multiple AM products created using existing approaches, the following observations are made:

- while similar in nature, every approach produces a different function structure for the same AM product or part,
- approaches have multiple ways of representing the same functionalities,
- regardless of the used approach, the same functionalities are not consistently represented across different products,
- the uniformity of function structure representation is not achieved.

Similar issues are also reported in the literature. For example, Kurtoglu & Campbell [53] reported the issues with determining the granularity of function structures in reverse engineering of consumer products they used to derive grammar rules for the creation of configuration flow graphs. Relatedly, Caldwell et al. [126] reported the inconsistent use of Functional Basis terminology. The inconsistency manifests in two ways: firstly, through simultaneous use of terms from different hierarchy levels and secondly, through using terms outside the defined vocabulary.

3.3.2 Consolidation of Function Structures

As the initial function modelling did not provide a consistent representation of AM products function models a consolidation of function structures is conducted. This is an iterative procedure directed to achieve a common and repeatable representation of function structures and define a function modelling approach for the domain of AM products. The consolidation is performed on subfunctions and flows level by comparing the same intended functionality across the pool of AM products. This enabled the consolidation of function structures to achieve the common representation of functions in the domain of AM products. Parallely with the consolidation phase, the categorisation of consolidated elements needed for function modelling and creation of function structures is conducted. Consolidation and categorisation phases correspond to data analysis and building theory phases of the inductive approach (Figure 3.1) and are performed using the protocol shown in Figure 3.6. The protocol is developed based on the protocol for the formalisation of function verbs [159] with extension regarding the definition of flows, and primary and modelling rules according to the posed RQs.

AM products are created or modified. Once preliminary function structures are created, the three parts of a function modelling language (vocabulary, morphology, and syntax) are consolidated through three analyses using the defined protocol (Figure 3.6). Firstly, the vocabulary used for defining functions and flows is checked. Here the consistency of terminology and function + flow format of expressing product functions are verified. The step confirmed Functional Basis's secondary level of vocabulary is appropriate for modelling function structures of AM products [126]. However, some functions (*Couple*, *Actuate* and *Regulate*) and flows (*Biological Energy*, *Electrical Energy*, *Magnetic Energy*, *Radioactive Energy*) did not appear due to the characteristics of the pool of AM products analysed. On the other hand, additional four terms are added to describe the domain of AM products completely. These are function *Allow DOF* and flows *Particulate*, *Surface*, and *Colloidal*.

Secondly, the consolidation of function blocks' morphology (arrangement of input and output flows) and their accordance with primary rules is conducted. This step is a central part of the analysis as it compares functions and function blocks across function structures of different products. The analysis revealed that the same functions are used in different contexts with different combinations of input and output flows depending on the context. For example, the function *Transfer Energy* is used in three different contexts, for transfer of energy from the system onto the carrier material, for transfer of energy from the system onto the carrier material with the occurrence of energy losses, and for transfer of energy from carrier flow onto the system (Figure 3.7).

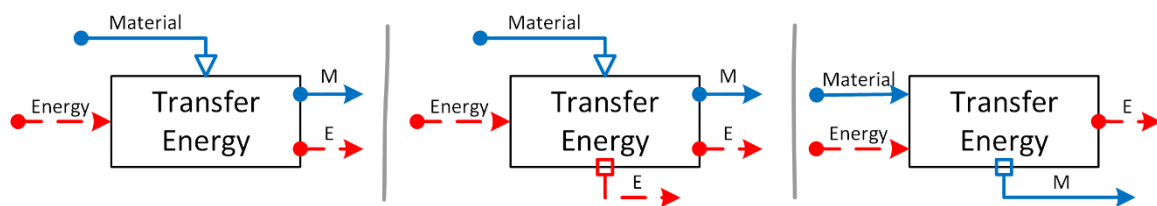

Figure 3.7 Three morphologies of function *Transfer Energy*

In the first case, energy enters the function block from the left side while material flow needed for energy transfer is enabling flow and enters from the top of the function block. The flows exit the function block on the right side in the carrier-carried relation. A similar morphology is used for the second case, with the addition of auxiliary flow representing the energy losses exiting at the bottom of the function block. In the third case, energy and material flows enter the function block in the carrier-carried relation. The energy exits the function block as a main output flow, while the material exits the function block as an auxiliary flow.

By observing the similarities, the functions and their morphology can be consolidated as templates to be applied in the appropriate context. The templates categorise the function blocks through definitions of the type of operating flow, as well as inputs and output flows. Their definition integrates the primary rules, such as conservation rule or input & output rules. Hence, templates define the function blocks and their interaction with input and output flows. At the same time contain class intelligence that acts as a container of design knowledge about a particular function and its intention in a function model. Therefore, the templates are called Function Classes (FCs) and are comprehensively described in Section 4.2.3.

The final consolidation step of functional analysis is the consolidation of function blocks and function chains arrangement, and interrelations inside the function structure. Here function structures are compared, and modelling rules are derived to support the uniform arrangement and representation of function structures.

3.3.3 Results

Parallely with the consolidation stage, the categorisation stage of functional analysis is performed. The stage is focused on the formalisation of described observations through the formal definition of four elements of modelling language: (i) graphology - defined graphical elements (Section 4.2.1), (ii) lexicon - vocabulary of functions and flows (Section 4.2.2), (iii) morphology - the definitions of function blocks (Section 4.2.3), and (iv) syntax - modelling rules (Section 4.2.4), that together make the grammar for functional modelling [112,160]. By following the consolidation and categorisation protocol, the elements of function modelling language are reviewed, consolidated, modified, and new parts of elements are added when necessary. Then, the analysis is repeated until no new parts of elements are encountered (Section 3.6).

The outputs of the Study of AM Products & Parts Functions are reflected through the definition and categorisation of:

- 16 primary rules,
- 12 modelling rules,
- 45 FCs.

3.4 Study of AM Forms

This section is based on the journal paper [161].

The second study of empirical research is an analysis of AM design solutions conducted on the pool of AM products. The goal of the analysis is to identify the design solutions that emerge from AM's unique design and manufacturing capabilities and are used for solving design

problems or improving product performance. The identified design solutions represent a source of AMK that can be stored in the form of AM DPs as a formal knowledge explication. The analysis and extraction of DPs is an inductive approach based on the observations of key features and functionalities of AM products and forming patterns to derive AM design principles. There are multiple examples of inductive approaches being used for deriving various DPs. For example, “Transformation Principles” [154] and “Tolerance design principles” [156] are derived using induction, and according to Fu et al. [49], induction is the most used approach for deriving DPs and other knowledge explications. Furthermore, the inductive approach has also been used for deriving AM design knowledge, like in the work of Blösch-Paidosh & Shea [47] and Perez et al. [48].

3.4.1 AM Form Analysis

The AM Form Analysis is based on Yilmaz & Seifert’s [155] approach for deriving design heuristics, which has been used, with slight modifications, for deriving AM design heuristics as well [14,47]. However, the specificity of the approach used in this thesis is the emphasis on AM products functions during analysis as they are solution-neutral representations of a product [114,162], and as such can be easily compared to the AM based form, features and unique possibilities used for solving product functions. AM forms used to solve the product functions are observed and extracted during analysis.

The analysis uses the data gathered in Section 3.2 and function structures created during functional analysis in Section 3.3 as an input for the protocol. The protocol itself is made of two phases: data analysis to extract the patterns and forming of theory based on the identified patterns [49]. The phases are made of 4 steps shown in Figure 3.8. The process is described linearly, but its implementation is highly iterative, requiring numerous comparisons between products, features, and function structures.

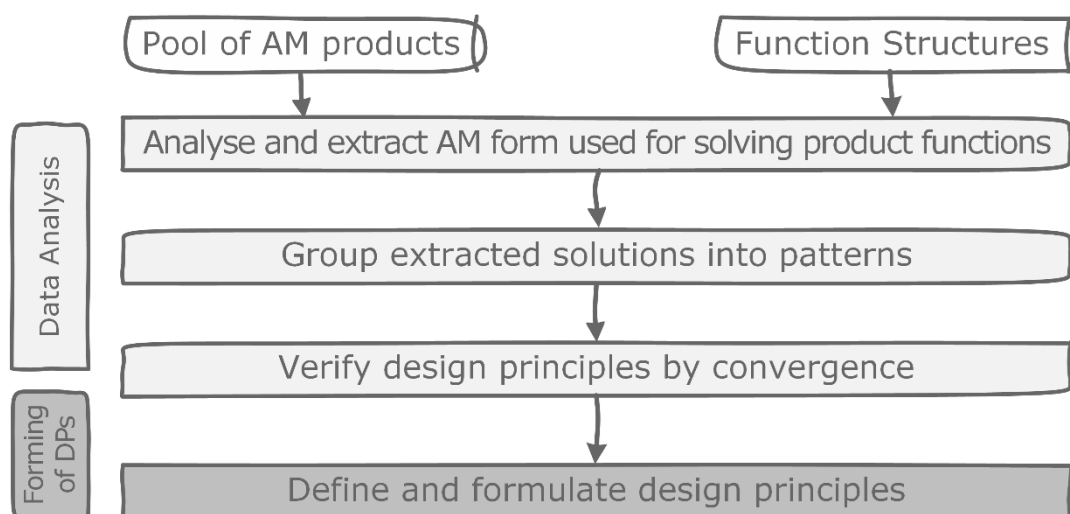

Figure 3.8 Protocol for AM form analysis (based on [47,155])

3. Analysis of AM Product & Parts

In the first step, it is observed how individual product functions are solved using AM capabilities. Here key features and AM solutions are documented and compared with created function structures. The focus of observations is to understand how the functions of a product are solved using AM and what are the benefits of using AM. The used AM forms are mapped onto product functions and extracted. In the second step of data analysis, the extracted solutions are grouped into patterns and consolidated through iterative analysis. New products are added, and the analysis is repeated until a number of extracted DPs converge to an asymptotic value. In the final phase of the proposed methodology, the grouped observations are formalised into DPs using the predefined syntax (comprehensively described in Chapter 4).

To illustrate the data analysis process of extracting AMK described above and performed on the pool of AM products, the example of analysis conducted on the AM milireactor is explained and shown in Figure 3.9. The AM milireactor is a piece of laboratory equipment used to synthesise liquid chemicals [41,163]. The purpose of the milireactor is to quickly synthesise two liquid chemicals by inducing the turbulent flow in small channels using internal chambers and barriers. Furthermore, as it is used for experimental synthesis, it must provide a way for visual observations of the synthesis. The product analysis starts with the creation of the function structure (top of Figure 3.9). The function structure is made of ten functions operating on the flows of *Liquid*, *Chemical Energy (CE)* and *Status* (visual information). In the second step of data analysis, it is observed how functions of a product (bottom of Figure 3.9) are solved using AM solutions. Four observations are documented. Functions *Import Liquid* and *Export Liquid* are solved by integrating the threaded channel opening (marked red). Function *Guide Liquid* is solved using winding channels integrated into the body of milireactor (marked green). Function *Mix Liquid and Liquid* is solved with internal chambers and geometry that increase the turbulent flow and enable better mixing of liquids (marked purple). Finally, one of the requirements of the milireactor is to allow visual observation of chemical reaction and mixing of liquids, thus individual functions related to this requirement (*Sense Liquid*, *Indicate Status*, *Export Status*) are solved using semi-transparent material and material distribution to allow visual observation through the entire length of the milireactor channel (marked orange).

For the presented example, the red observation is combined with other similar solutions found in other AM products and generalised into principle #DP6 (*Enable interaction with environment by integrating standard geometry*), the green observation became #DP9 (*Enhance fluid performance by using integrated internal channels*), the purple #DP10 (*Enhance material/energy conversion by shaping internal chamber for the use case*), and orange #DP27

(Convey information and/or change permutability of light by applying custom material distribution).

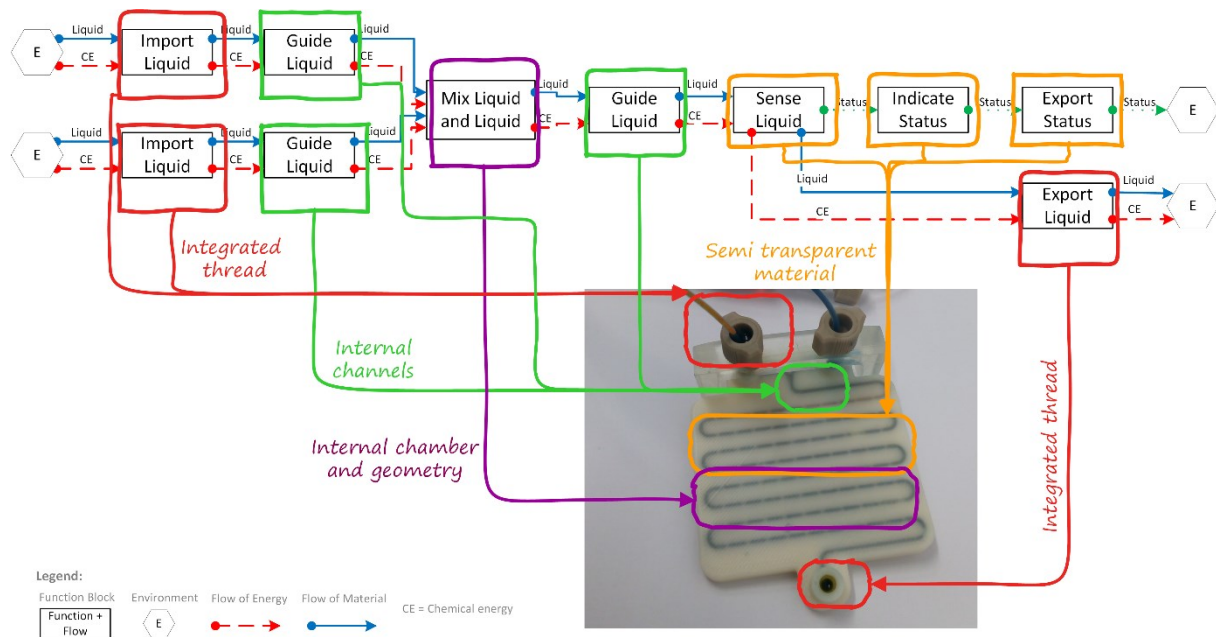

Figure 3.9 Example: Analysis of AM milireactor

3.4.2 Results

The AM Form analysis resulted in the derivation of 32 AM DPs. The AM DPs are part of the Mapping Method, which maps product functions and DPs using MRs. The definition and description of AM DPs are provided in Section 4.3.2.

3.5 Study of AM Form-to-Function Relations

The final empirical research study is used to extract and formalise mapping rules for mapping product functions and AM DPs. It is based on the premise that form-to-function relations from existing designs can be reversed and formalised in a set of mapping rules to perform function-to-form mapping in new design development [51]. The approach used for performing the form-to-function analysis is similar to a methodology used by Kurtoglu & Campbell's for mapping function structures with components of electromechanical products [53]. Their approach for grammar rule derivation consists of four steps. Firstly, the product is taken apart to evaluate its functionality and components used as a solution. In the second step, a function structure and so-called configuration flow graph are created. The configuration flow graph represents relations between functions and components used to solve those functions. Third, the mappings between function blocks and components are extracted from the configuration flow graphs. Finally, the extracted mappings are used to define formal rules for function-to-form mappings in the fourth step.

3.5.1 Form-To-Function Analysis

The goal of the form-to-function analysis is to derive rules for mapping product functions with DPs for AM by observing relations between functions of the products from the pool of AM products and the form that is used as a solution. These relations are observed and extracted using the protocol shown in Figure 3.10. The analysis is conducted on the same set of products as the rest of the empirical research; hence the data gathered previously (AM products, function structures and DPs) is used as the input.

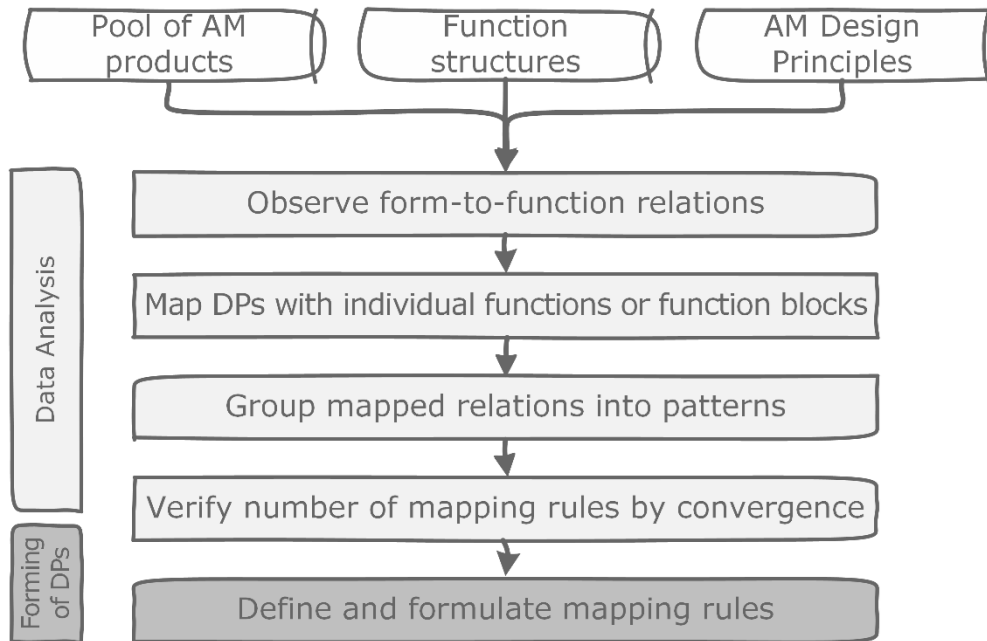

Figure 3.10 Protocol for form-to-function analysis

The first step of the analysis is the observation of form-to-function relations. Each product from the pool is observed and its function structure is compared to an embodiment of DPs it contains. Here attention is given to identifying what are the relations between product functions and form that is used to solve individual functions or block of functions. In the second step the identified relations between form (DPs) and functions are mapped. The mappings include one-to-one correlations between a function block and DPs, as well as many-to-one and many-to-many relations. The possibility of mapping multiple functions as a single relation supports function integration. Each mapping, when reversed, represents a potential MR for function-to-form mapping. If more than one function structure is created for a product, the process is repeated for each function structure. Once the form-to-function mappings are conducted for all the products, the mapped relations are grouped into patterns. Each group is reviewed and edited in an iterative process to generalise the observed form-to-function mappings. Finally, once all extracted mappings are consolidated across all products, they are inverted, and the rules are formalised in a set of function-to-form MRs.

The example of analysis conducted on the space pointing mechanism with two degrees of freedom is shown in Figure 3.11. The product embodies three different DPs used for solving product functions. The top of the figure shows the design principles mapped onto a function structure. The function *Import ME* is mapped with #DP6 (standard interface) which is embodied in two places (marked red). Block of functions *Import*, *Position* and *Secure Solid* are solved as mapping many-to-one, with the #DP6 (marked blue). Similarly, functions *Allow DOF ME*, and *Position Solid* are mapped with #DP19 (enable movement with compliant mechanism) (marked green). Function *Export ME* is mapped with #DP7 (custom interface) (marked yellow), while function *Export Solid* remains unmapped.

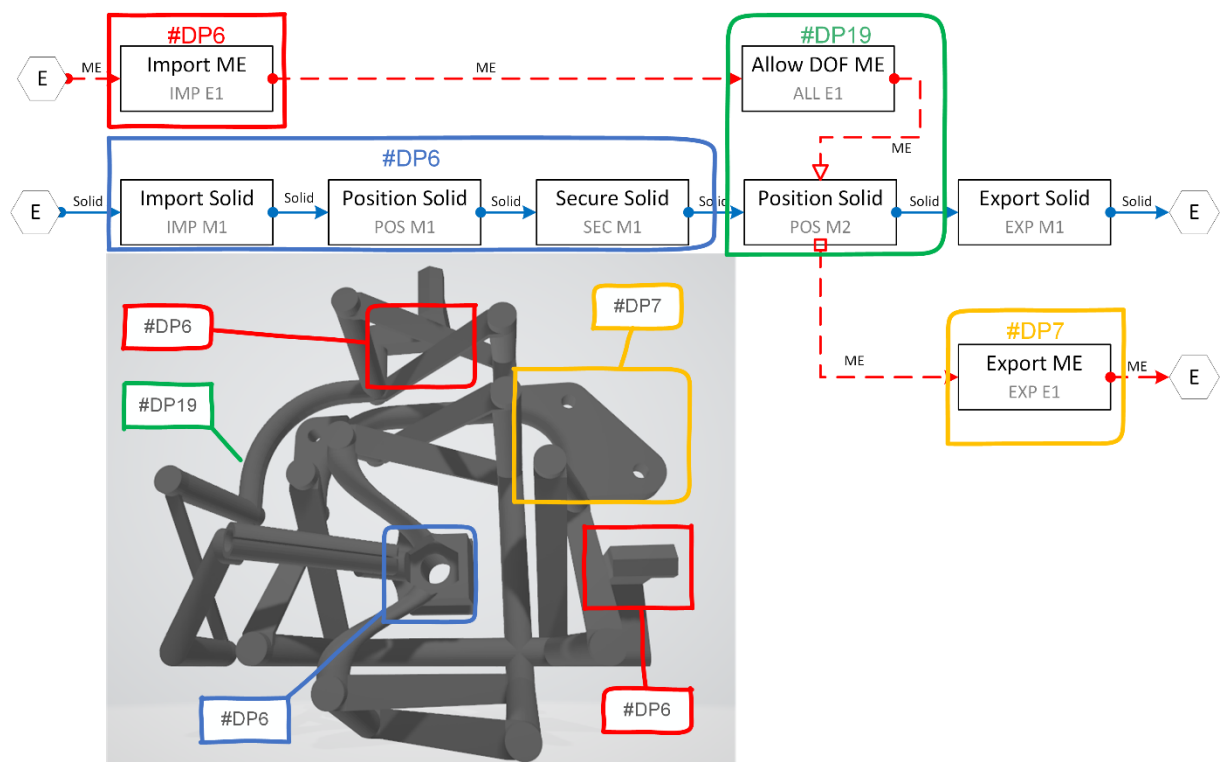

Figure 3.11 Example: Form-to-Function analysis of space pointing mechanism

The observations from all conducted analyses are grouped into patterns based on the similarities of mapped function blocks. The patterns are generalised into the function-to-form rules, where for a given individual function or block of functions, one or more DPs are suggested as a potential solution. For the presented example, the red relation became the rule *Import Mechanical Energy* mappable with #DP6 and #DP7. The blue observations became rule *BR-SU1 - Passive interaction with solid objects* mappable with #DP6, #DP7 and #DP7 + #DP20. The green relation became rule *BR-CH7 - Active movement of the system* mappable with #DP19, #DP20, #DP23, #DP30, #DP32 and #DP20 + #DP32. The yellow relation became rule *Export Mechanical Energy* mappable with #DP4, #DP5, #DP6 and #DP7

3.5.2 Results

The form-to-function analysis resulted in the derivation of 42 MRs. The MRs are part of the Mapping Method and enable the mapping of product functions and AM DPs. The definition and description of MRs are provided in Section 4.3.1.

3.6 Convergence of Results

When conducting research by analysing the empirical data, the question is how big a data set is needed for the analysis and when the analysis can be stopped. The strategy used to determine the needed sample size is the convergence analysis, often used in inductive approaches for knowledge extractions [49] (e.g., [53,103,127]). In convergence analysis (asymptotic analysis), the number of data observed is compared with the number of unique observations. The analysis is continued until the number of observations converges to a horizontal asymptote [49]. Figure 3.12 shows the convergence of derived FCs, DPs and MRs. The horizontal axis shows the chronological number of analysed AM products, while the vertical axis marks the total number of extracted FCs, DPs, and MRs. When the graph is observed for the initial set of 15 products (dotted line), the rate of deriving new instances is lower with each new product, but convergence is not achieved. The empirical analysis continues in sets of 5 new products until results converge, and no new FC, DP or MR is found in an additional set. The derived DPs converged after 25 analysed products (grey dashed line) with 31 found DPs. However, one more DP is derived later. The FCs converged after 30 analysed products (green dashed line), with an additional one FC derived later. The final to converge is the number of derived MRs. Convergence of MRs occurred after 40 analysed products (blue dashed line). As the 7th set of 5 products did not reveal new instances of FCs, DPs, and MRs the analysis is stopped. The derived sets are not definite, but the convergence of results indicates that most instances for the given criteria are derived.

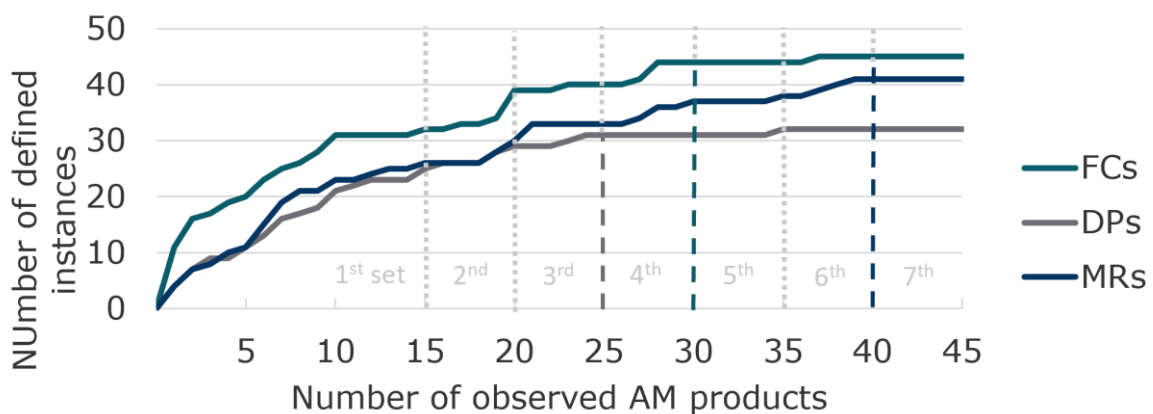

Figure 3.12 Convergence of derived FCs, DPs, and MRs

4

Mapping Methodology

Chapter 4 presents the Prescriptive Study where the methodology for mapping product functions and AM design principles is proposed. The Mapping Methodology is made of two design methods and concept generation. The first method is a Function Class Method, a function modelling method based on predefined function block templates, supported by modelling rules and Function Classes. The second method is Mapping Method which uses AM Design Principles and Mapping Rules to suggest potential AM solutions to the designers.

4.1 Mapping Methodology

The methodologies are the broadest type of design supports that provide an overall framework for doing design [55]. Hence, the Mapping Methodology defines the overall framework for conducting the early design phases of AM oriented design process. It is made of two developed methods, Function Class Method (FC Method) (Section 4.2) and Mapping Method (Section 4.3). The methods prescribe a sequence of activities that need to be performed to complete a design task or activity [55]. In the Mapping Methodology, the FC Method supports the function modelling process that creates a function structure of an AM product, while the Mapping Method supports the mapping process and enables the mapping of product functions and AM DPs. Five design tools are used as low-level support for supporting operational and proficient use of methods and the Mapping Methodology [55]. The modelling rules (Section 4.2.4) and Function Classes (FCs) (Section 4.2.3) support the FC Method, while AM DPs (Section 4.3.2) and Mapping Rules (MRs) (Section 4.3.1) support the Mapping Method. Finally, the computational prototype framework, the Function Mapping Application (FM App) (Chapter 5), provides the computational support for applying the Mapping Methodology and its parts.

Through its methods and tools, the Mapping Methodology provides the systematic approach for the early phases of AM oriented design process. As already discussed in the introductory chapter, the systematic nature of the Mapping Methodology, among other benefits, will provide support for routine design activities, exploration of AM design space, and help designers to find creative AM based solutions or find solutions they would not intuitively think of. Furthermore, the use of functions as solution neutral representation of a product enables common relation among the parts of the methodology, ensures the systematic approach, and enables integration

4. Mapping Methodology

of the Mapping Methodology inside existing and future frameworks for the systematic design process [18]. On the other hand, the methodology differs from the common design process and DfX approaches by applying specific design knowledge about AM early in the design process before product concepts are generated. While this somewhat limits the conceptual design as only AM based solutions are considered, it enables better utilisation and integration of unique AM possibilities into the product and supports function integration enabled by AM geometrical and functional complexity.

The use of Mapping Methodology and its subparts is prescribed through the framework shown in Figure 4.1. The framework defines the sequence of design activities that must be carried out during early design phases and prescribes the inputs and outputs among them. The framework supports function modelling of future AM products, the creation of function structures, and mapping with AM DPs. This process creates so-called Mapped-Function-Principles Structures (MFP Structure) that is used to generate AM product concepts which contain preliminary layouts and embody AM design possibilities. The inputs to the Mapping Methodology are design requirements, and customer needs defined in the planning phase of the design process [28,32]. The activities of this phase are not part of the proposed methodology, and common design tools for the planning phase should be used (e.g., market research, interviews, focus groups, etc. [18,28,31,135]) to define design requirements and customer needs prior to using the Mapping Methodology.

The design activities of the Mapping Methodology start with the creation of a function structure for a future product or part. In this stage, the designer creates one or more function structures to represent the functionality of the product that will satisfy user needs defined in the planning phase. As the function structures will be mapped later in the framework, it is essential to ensure the common representation of function blocks inside the function structure needed for the application of MRs. This is achieved through the use of the FC Method, which defines the steps of function modelling activity, and provides modelling rules and definitions of product functions through FCs. The output of the function modelling stage is one or more function structures compliant with the FC Method used as input for the mapping activity.

In the second stage of the Mapping Methodology, the function structures are mapped using the Mapping Method. The Mapping Method uses MRs to find the possible AM DP to be used to create solutions for fulfilling partial functions or blocks of functions. In an iterative process, the designer applies MRs and chooses AM DPs to create one or more MFP Structures. The MFP Structure represents the abstract layout of the future product and shows mappings between product functions and AM DPs.

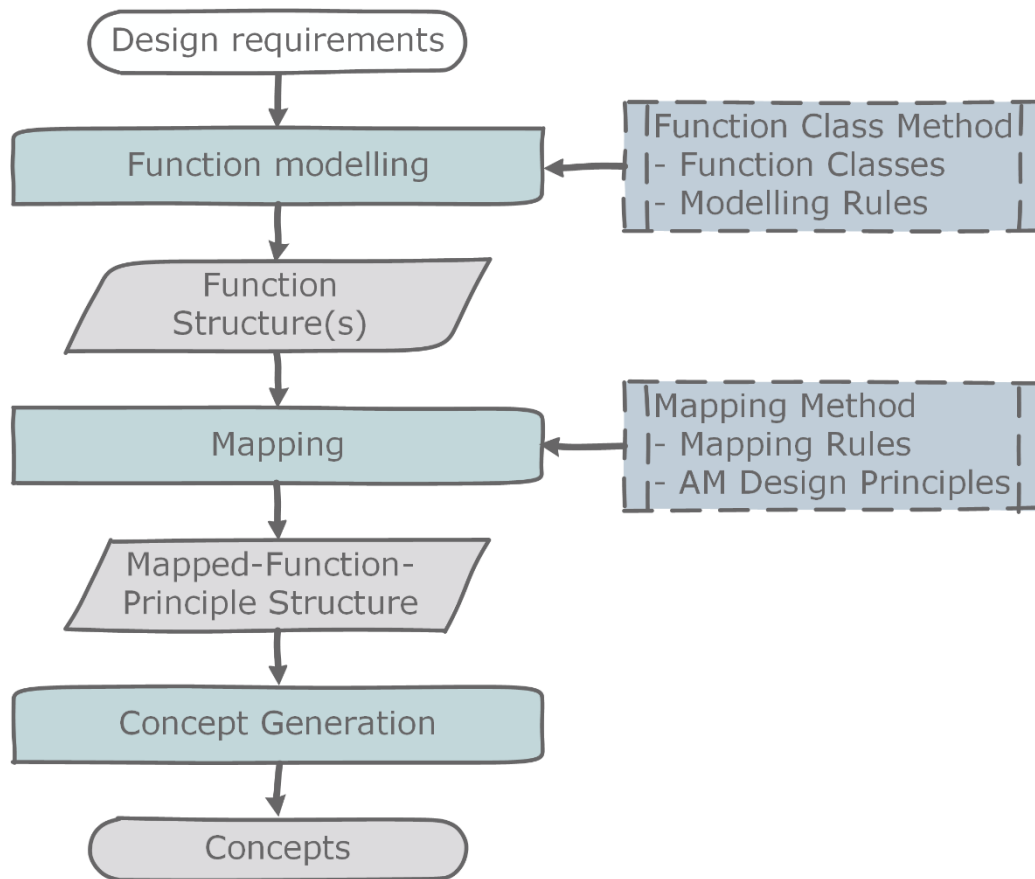

Figure 4.1 Mapping Methodology Framework

Finally, created MFP Structures are used in the concept generation, where the mapped DPs are embodied to solve the functions of the product. In this step, the designer uses the MFP Structures as an input for concept generation. How the concepts will be made and represented depends on the designer's preference, as the Mapping Methodology does not prescribe the process details. However, the goal should be to create multiple concepts for the product as a greater number of generated ideas increase the chance of generating better ideas [164]. The outputs of the methodology are concepts that utilise the AM possibilities. Once the concepts are created, the concept selection and other design activities of embodiment and detail design should be carried out. These activities are not prescribed with a Mapping Methodology and depend on the overall design process, design context, and designer's preferences in approaching the design process. To illustrate how the Mapping Methodology should be used with all its methods and tools, an example of redesign a screwdriver is provided in Appendix A.

As could be seen from the description above, the Mapping Methodology is not a standalone entity for conducting the entire design process, but rather it is used for facilitating the design activities in the early design phases of the overall design process being carried out to design and develop an AM product or a part. While the Mapping Methodology is made of specific methods and tools for AM, it can be easily incorporated into existing systematic design

4. Mapping Methodology

processes for general product development due to defined inputs and outputs that match their prescribed frameworks. Figure 4.2 shows the position of the Mapping Methodology (marked with purple dashed rectangles) in two common systematic design processes. When the systematic design process proposed by Otto & Wood [28] is observed, the Mapping Methodology is placed inside the concept development phase. Still, it does not include all design activities carried out in this phase and even reaches out to the phase of concept implementation and embodiment engineering. Similarly, if Pahl & Beitz's [18] systematic design process is observed, the Mapping Methodology corresponds to the phase of the conceptual design and phase of early embodiment design. The activities of concept and preliminary layout development correspond to the activities of the Mapping Methodology. Due to the use of the same inputs and outputs, the Mapping Methodology can replace the prescribed phases of these design processes and be easily incorporated into the overall design process framework.

At the same time, Mapping Methodology can be easily incorporated into a purposely built DfAM design process framework proposed by Kumke et al. [77]. DfAM framework includes three design phases and has 9 general modules for conducting design activities. The Mapping Methodology entirely corresponds to the conceptual design phase (Figure 4.3). Furthermore, the FC method corresponds to Module 2 (Determination of functions and their structures), while Mapping Method and Concept Generation correspond to Module 3 (Development of basic solution ideas). Therefore, using the Mapping Methodology inside the DfAM framework will enable not only the conceptualisation of AM based solutions but also their embodiment design, detail design and ensure manufacturability of the design.

The compatibility of the Mapping Methodology with the different prescribed design processes enables its easy integration and utilisation of existing design methods and tools in the creation of new AM products. It should also facilitate the adoption of the proposed Mapping Methodology in design practice as it is placed in the context of the design process many designers are familiar with. The following sections describe the FC Method (Section 4.2) and Mapping Method (Section 4.3), the core parts of the proposed methodology.

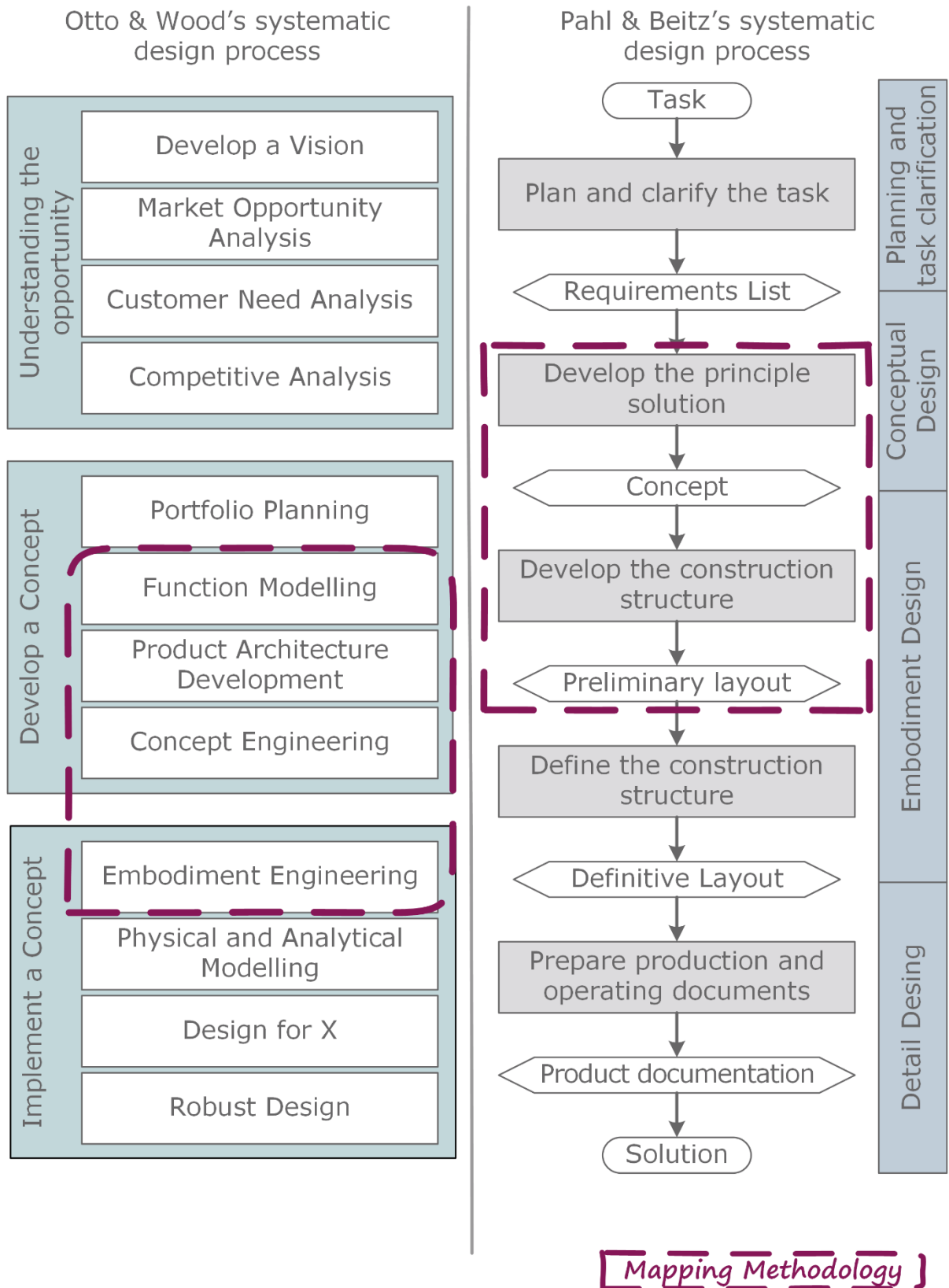

Figure 4.2 Position of Mapping Methodology inside the systematic design processes [18,28]

4. Mapping Methodology

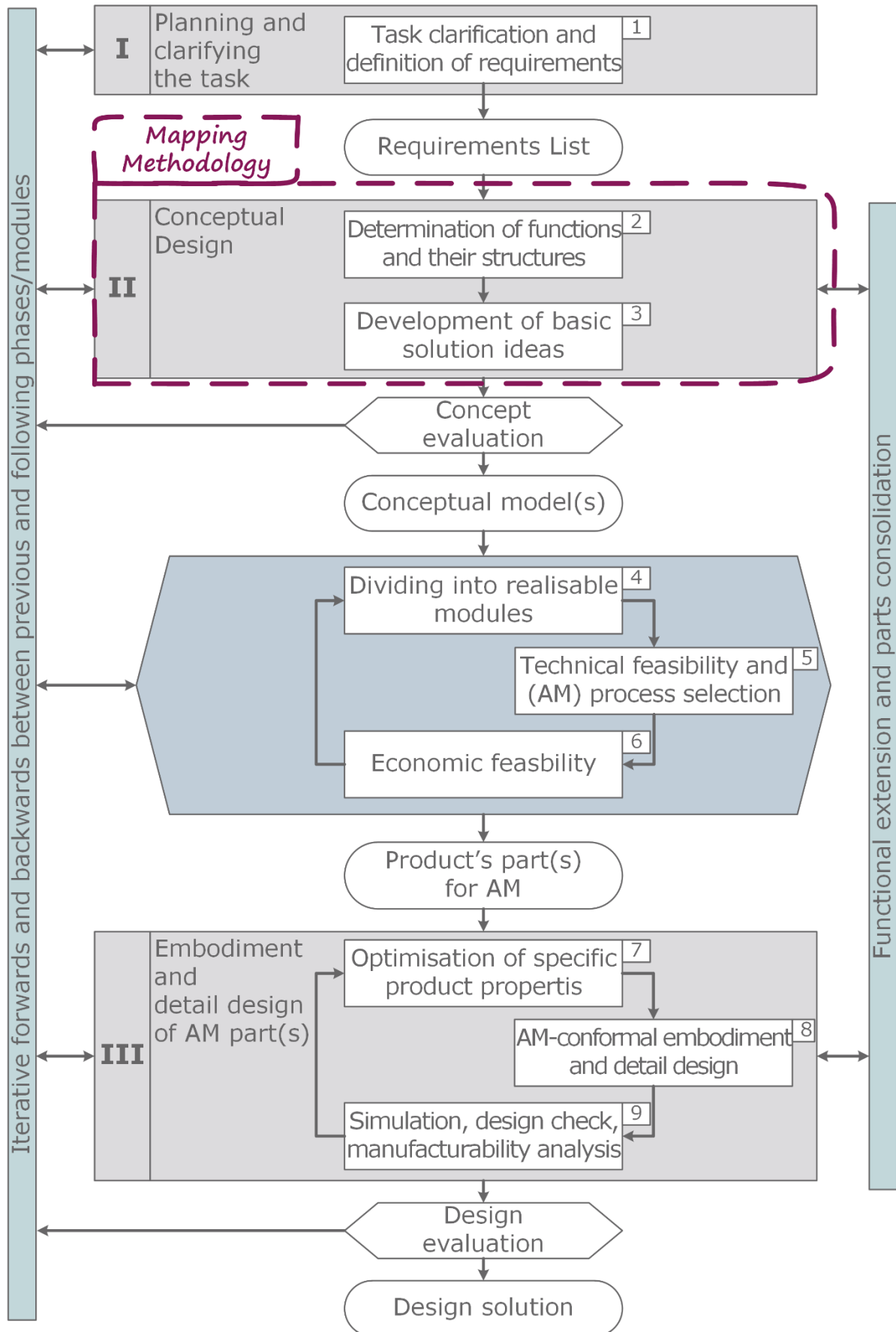

Figure 4.3 Position of Mapping Methodology inside the DfAM Framework by Kumke et al. [77]

| 4.2 Function Class Method

This section is based on the submitted paper [157].

To enable mapping with AM DPs, function modelling inside the Mapping Methodology must enable the repeatable creation of function structures of future AM products, with the uniform representation of function blocks and function chains. Hence, a function modelling approach based on the use of function block templates is proposed – the Function Class Method. The FC Method provides a systematic approach to function modelling, that enables consistent creation and representation of function models expressed in the form of function structures. To achieve the stated the FC Method utilises four elements of a modelling language (graphology, lexicon, morphology, and syntax) [112,160] to create function structures with consistent and common representation. The central part of the FC Method is the use of predefined templates in the form of Function Classes (FCs) that define morphology on a function block level. Each FC provides a classification of the function block that includes the definition of function and operating flow as well as the input and output flows. The FCs are supported by the defined graphology and prescribed lexicon of verbs and nouns for defining functions and flows. Furthermore, the application of FCs and their arrangement in coherent function structures are enabled with the modelling rules.

The framework of the FC Method shown in Figure 4.4, prescribes the steps and activities of the function modelling process, provides systematic guidance through the process, and enables the correct application of FCs and modelling rules. The modelling process consists of four phases, where each phase is made of several steps and activities:

- 1) Modelling the Black Box model (optional),
- 2) Modelling subfunctions using FCs and connecting them into function chains,
- 3) Combining subfunctions and function chains into an overall function structure,
- 4) Reflection on the function modelling process.

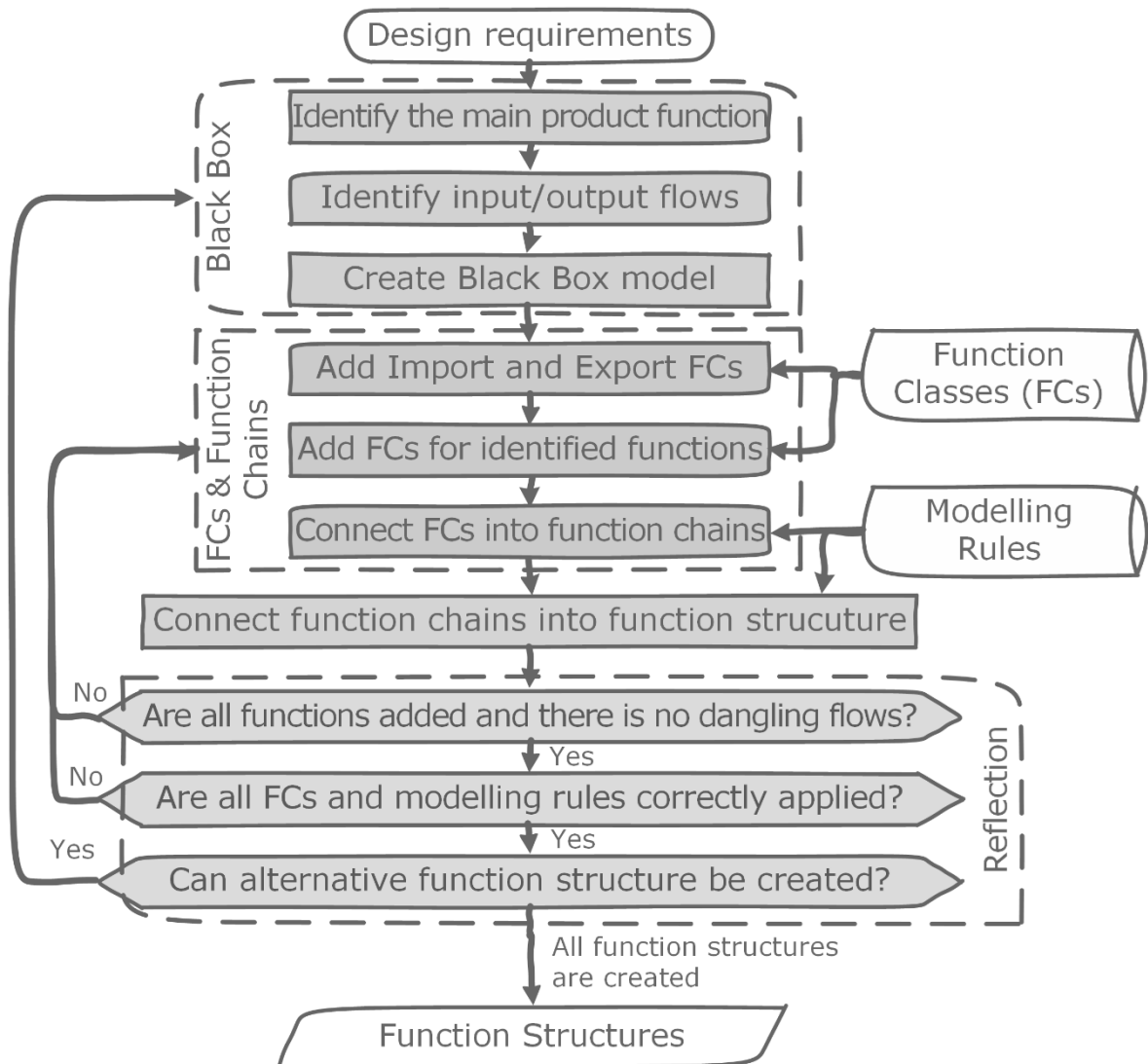

Figure 4.4 Function Class Method's Framework

The function modelling process starts with the common approach of identifying the main product function, and for this, user needs and requirements are reviewed, and used as input for the creation of the Black Box model [115]. Based on the requirements, firstly, the main product function is identified, followed by identifying the main input and output flows. Here it is important to have a qualitative assessment of the conservation rule and check that the sum of inputs equals the sum of output flows in a Black Box model. This phase is not mandatory but is strongly encouraged as it facilitates the rest of the process and aid in the assessment of the conducted function modelling.

In the second phase, firstly, the FCs are added, starting with *Import* and *Export* functions, main subfunctions, and continuing with other easily identifiable subfunctions. After adding FCs, in the third phase, they are connected with appropriate flows following the modelling rules. Following this process, some flows will be dangling, and additional subfunctions will be identified. Iteratively, additional FCs are added and connected with flows until the final

function structure is created and checked for compliance with FC Method. The final phase of the FC Method is to reflect on the function modelling process and, if applicable, to create alternative function structures that can have some different or additional functions and flows.

The following sections provide the descriptions of FC Method elements derived from the literature review (Section 2.3) and functional analysis of AM products (Section 3.4).

4.2.1 Graphical Representation

The first element of modelling language is graphology or the definition of elements for graphical representation of function structure. The formally defined graphical elements ensure a formal and unequivocal representation of function models in the proposed approach. The graphical elements are function blocks, flows, and system boundaries (Figure 4.5). These elements are based on the common representation of elements [18,116,129] found through the literature review in Section 2.3.

The function block expresses the subfunction of the product, and it is graphically represented through a rectangular block. Flows are represented through arrows connecting the function blocks, where the arrowhead indicates the direction of the flow. Material flow is a solid blue arrow, energy flow is a red dashed arrow, and information flow is a green dotted arrow.

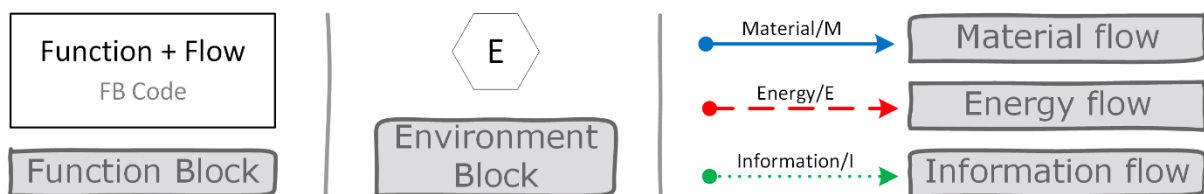

Figure 4.5 Elements of graphical representation [18,116,129]

The proposed FC method recognises different types of flows (described in detail later in the chapter); hence it is necessary to follow a single way of the flow representation to capture the flow type and role in a function structure (Figure 4.6) [134]. The main input flow(s) should always enter the function block from the left side of the block and is indicated with a filled arrowhead on the flow. Enabling flow enters the block on the top side of a function block with a closed arrowhead indicating enabling flow. The main output flow(s) exit the function block on the right side with a filled dot on the end tail of the arrow as an indication of the output flow, while the auxiliary flow exits at the bottom of the function block with a closed square to indicate auxiliary output flow. The flows in carrier-carried relation are indicated in a function structure when two flows have the same output and input blocks (Figure 4.7) [132]. Carrier flow should be put above the carried flow.

4. Mapping Methodology

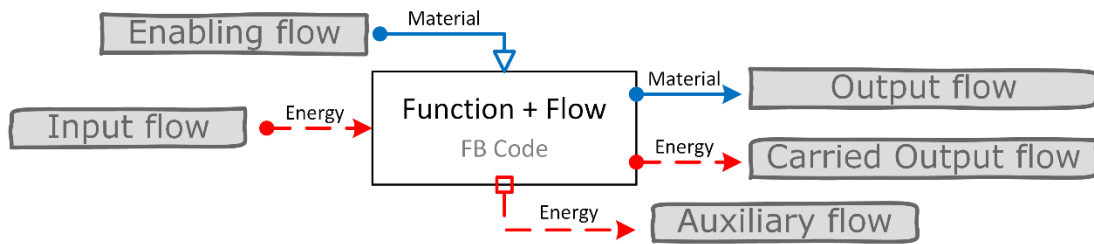

Figure 4.6 Representation of flows entering and exiting function block [134]

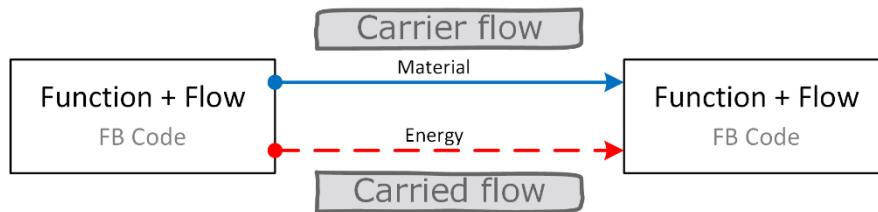

Figure 4.7 Representation of flows in carrier-carried relation [132]

The final graphical element is the system boundary [18,28]. The system boundary defines the area of product operations. The function blocks inside the system boundary are subfunctions of a product, while the flows that cross the system boundary represent the system's interaction with the environment. The environment is represented with a hexagon and the letter E (Figure 4.5) [116,129].

4.2.2 Vocabulary

To have a consistent representation of a function model, it is necessary to have a predefined vocabulary to define functions and flows. The existing vocabularies and their benefits and drawbacks are described in Section 2.3, and following the previous research on predefined vocabularies [110,125,126,165], the Functional Basis [118] is chosen as the base for the development of the FC function modelling approach. To date, the Functional Basis is the most used vocabulary [123], and its usefulness and appropriateness for function modelling have been proven through experimental research [110,125,126,165]. However, as the goal of the FC approach is to support the creation of a function structure with consistent representation that will be suitable for computational reasoning, a multilevel vocabulary would represent an additional challenge as the same function, or a flow can be represented on various levels of granularity. Therefore, a single level vocabulary is needed to remove any ambiguity in expressing the meaning of functions and flows. Therefore, the second level of Functional Basis is chosen as a base vocabulary, as it is a level with the highest expressiveness [126].

However, as the Functional Basis has some uncertainties in the definitions of functions and flows [128,166] and as difficulties in defining a few functions and flows are encountered in the empirical study (Section 3.3), the secondary level of vocabulary is modified by adding

additional terms. Function *Allow DOF* is added from the third level to describe product movement because the term *Guide* did not fully explain the intended functionality. In the original Functional Basis, *Solid* is subdivided into *Object*, *Particulate*, and *Composite* to provide a fine representation of the solid flow. As object and particulate have different physical properties, the term *Solid* is used to represent a material with a definitive firm shape – an object. At the same time, *Particulate* describes a substance made of separate particles. Furthermore, the new term *Surface* is added to represent a material that is stationary in the environment and cannot be wholly absorbed by the system. Similarly, the term *Colloidal* is adopted from the tertiary level as the term for representing flow of tiny particles suspended in air (i.e., aerosol).

For categorisation, the primary level is kept, but it is not to be used in functional modelling. Furthermore, due to the characteristics of the current state of AM and the pool of AM products analysed, some functions and flows are not encountered in this study. Nevertheless, they are kept as placeholders in the vocabulary for the future development of FCs. The complete vocabulary of functions and flows is presented in Table 4.1.

Table 4.1 Vocabulary of function and flows

Functions		Flows		
Branch	Separate	Material	Human	
	Distribute		Gas	
Channel	Import		Liquid	
	Export		Solid	
	Transfer		Particulate	
	Guide		Surface	
	Allow DOF		Plasma	
Connect	<i>Couple</i>		Mixture	
	Mix		Colloidal	
Control	<i>Actuate</i>		Energy	Human (HuE)
	Magnitude	<i>Regulate</i>		Acoustic (AE)
		Change		<i>Biological</i>
	Stop	Chemical (CE)		
Convert	Convert	<i>Electrical (EE)</i>		
Provision	Store	Electromagnetic (EME)		
	Supply	Hydraulic (HE)		
Signal	Sense	<i>Magnetic</i>		
	Indicate	Mechanical (ME)		
	Process	Pneumatic (PE)		
Support	Stabilize	<i>Radioactive (Nuclear)</i>		
	Secure	Thermal (TE)		
	Position	Information		
		Status		
		Control		

*Bolted terms are new terms to the secondary level of FB

**Terms in italic were not encountered in this research but are placeholders for future FCs development

4.2.3 Function Classes

The third element of a modelling language is morphology. Morphology defines the subfunctions of a product through function blocks and embodies the basic concepts of function modelling. In the proposed FC Method, this element is defined through the conception of Function Class (FC). FC is a description of a product subfunction and its abstract realisation in a function structure that contains a description of possible operating flows, as well as input and output flows for each function, with respect to fundamental function modelling rules and concepts. The goal of the FC is to provide the template for modelling individual subfunctions to ease the process of function modelling and creation of function structure while ensuring the consistency in meaning and representation of a function model is achieved. Furthermore, this provides a formal description of product subfunctions and their interactions.

Each developed FC is compliant with basic function modelling concepts and a set of primary rules developed through the empirical study (Section 3.3, Figure 3.6). The primary rules (Appendix B.1) are applied on the function block level and are implicitly embedded into each FC. The following function modelling concepts and primary rules are embodied in the FCs.

The function is a solution-neutral way of describing the product operation on a flow of energy, material, or information [18,28,110] and must be expressed through terms of defined vocabulary (Rule #A). Functions of a product are represented through a function block and expressed in a verb + noun format [18] (Rule #B). The verb describes a function, and the noun describes the flow on which the stated function operates. The format is used for all functions apart from functions *Convert*, *Mix*, *Couple* and *Allow DOF*. The first three functions operate on two flows. Hence, they require conjunction between two stated flows (e.g., *Convert Liquid to Gas*, *Mix Liquid and Particulate*, *Couple Solid and Solid*), while the function *Allow DOF* (*degree of freedom*) perform only on the flow of mechanical energy not stated in the function block and is used to describe the movement of the system needed to perform another function.

Three types of flows exist in a function model: material, energy, and information [18]. Material and energy are physical flows and, as such, must follow conservation laws [18,116,129,130] (Rule #C). Every flow of energy or material that cross the system boundary or function block must exit the system or a function block, it can change its form, be combined with another flow, or split, but it cannot vanish. Also, no flow can just appear in the system without entering the system. Therefore, the sum of all energy or material input flows must be equal to the sum of output flows. Due to the abstract nature of the function structure, the rule must be checked with qualitative assessment rather than quantitative.

On the other hand, information flow is the abstract flow that represents any information that interacts with the system. Primarily, it should be modelled independently from other flows (Rule #D). Due to its abstract nature, the information flow does not have to follow conservation rule. It can enter and exit the system, but also a new information flow can be a result of a function block (e.g., information about system status), or the function block can absorb information (e.g., control signal needed for function operation). However, when needed, the information flow can be modelled with dependency on material or energy flow that acts as a carrier of information (e.g., electric impulse carries a piece of information) [112,129] (Rules #L, #M). In this case, information flow is modelled in carrier-carried relation with material or energy flow (Rules #N, #O), and the carrier flow needs to follow conservation law (Rule #D).

Every function block must have at least one input and one output flow (Rule #E). The main input flow is the primary flow of interest and one on which the function performs its operation. The main output flow is the primary product of function operation that exits the function block. However, these two flows are not enough to describe every product function; thus, two optional types of flows are enabling and auxiliary flows [134]. Enabling flow supports the function operating on the main flow, and it provides additional input necessary for the operation (Rule #F). For example, converting material from one form to another requires an energy source; hence the flow of energy for this operation is an enabling flow (e.g., conversion from liquid to gas requires thermal energy). Similarly, auxiliary flow represents the secondary output flow of a function block (Rule #G). Therefore, the flow of losses and other output flows of secondary interest are modelled as auxiliary flows. For example, when the transfer of mechanical energy from the system onto a solid object is conducted, often, energy losses occur in the form of thermal energy. These losses will be modelled as an auxiliary output flow. When all flows are added to the function block, the sum of flows must be according to a conservation law.

While the goal of function modelling should be to model the flows independently from one another, due to constraints imposed on the design in the form of design requirements or user needs, this is not always possible. For example, a design requirement could be that the system uses mechanical energy delivered through the shaft as an energy source. In this case, the two flows (energy and material) are dependent, and occasionally this relation must be captured in a function structure. To model such relations, a concept of primary and carrier flows is used [132,133]. The primary flow is usually the flow of interest, and the carrier flow is a supporting flow that carries primary flows through the system. In the example above, the shaft would be a carrier of mechanical energy. However, in the function chain, the focus can be shifted between the primary and carrier flows; thus, the notation of primary and carrier flows can be misleading.

4. Mapping Methodology

Furthermore, only combinations in accordance with the laws of physics are allowed. Therefore, to avoid the ambiguity of the representation, this concept will be referred to as the Carrier-Carried relation. When flows in carrier-carried relation enter a function block, a function always operates on a carrier flow (Rule #L) (e.g., system import shaft and through it mechanical energy) while the carried flow passes through. The exceptions to this rule are functions of energy *Transfer* and *Conversion*. Following the physics-based view, allowed carrier-carried relations are: (i) material flows carry energy or information flow, and (ii) energy flows carry an information flow (Rules #N, #O, #P).

All these concepts and rules are embodied in the form of FCs that act as a template for modelling product subfunctions. Each FC is defined by four elements: (i) FC Code, (ii) textual description, (iii) class description, and (iv) graphical template (Table 4.2). The FC code is a unique ID for each FC and is used as an identifier for each function block in the function structure. The textual description consists of FC's definition to transfer the meaning of FC and mode of operation to the designer and an example for easier understanding.

FC's class description uses the pseudo-code of an object-oriented class to formalise the elements of the FC [159]. The class description defines the type of operating flow and required input and output flows, with information regarding their type, number, and restrictions. For the development and definition of FC's class description, a protocol for formalising function verbs to support conservation-based model checking proposed by Sen et al. is followed [159]. Once developed, the class description enables a formal form of description that can be used for computational reasoning of function structure created through the FC approach. Finally, the graphical template is created to capture the class description formalism in a graphical form. The graphical templates are used to represent each FC in a function structure.

Table 4.2 Example of Function Class definition for function *Separate Material*

Code	Textual Definition	
	Graphical Template	Class definition
SEP M1	Separating material into two or more distinctive flows using an energy source. <i>Example:</i> Bottle opener separates cap (solid) from the bottle (solid).	
		OF_Type = M In_Type = M, n = 1 En_Type = E, n = 1 Out_Type = M (=/#In), n = 2 Aux_Type = M (=In),

Because a function can have more than one operating mode, a different FC definition is established for each operating mode. An example can be seen in Table 4.3, where three FCs for function *Transfer* are shown. Function *Transfer* can be used to model the transfer of energy from the system on material flow as an ideal system. Furthermore, it can be used for the same purpose, but significant losses occur and are modelled as an auxiliary flow from the function. Also, function *Transfer* can describe a transfer of energy from carrier flow on the system. As the example shows, function *Transfer* has three different operating modes, and for each operating mode, an individual FC is defined.

Table 4.3 Function Classes for function *Transfer*

Code	Textual Definition	Class definition
	Graphical Template	
TRA E1	<p>Transfer of energy onto the carrier material. The enabling flow of material is needed. Output flows of material and energy are in a carrier/carried relation. <i>Example:</i> Slingshot transfer the mechanical energy on the object.</p>	<p>OF_Type = E In_Type = E, n = 1 Out_Type = M (=In), n = 1; E (=In), n = 1 En_Type = M, n = 1 Aux_Type = /</p>
TRA E2	<p>Transfer of energy onto the carrier material. The enabling flow of material is needed. Output flows of material and energy are in a carrier/carried relation. Additional auxiliary flow is added to represent losses of energy. <i>Example:</i> Gear transfers the mechanical energy on second gear with losses in the form of thermal energy due to friction.</p>	<p>OF_Type = E In_Type = E, n = 1 Out_Type = M (=In), E (=In), n = 2 En_Type = M, n = 1 Aux_Type = E (=In)</p>
TRA E3	<p>Transfer of energy from carrier material onto the system. The main output flow is energy, while the material is the auxiliary flow. <i>Example:</i> Rotary blades transfer the mechanical energy of moving air on the system.</p>	<p>OF_Type = E In_Type = M, n = 1; E, n = 1 Out_Type = E (=In), n = 1 En_Type = / Aux_Type = M (=In), n = 1</p>

The FCs are a fundamental element of a developed FC Method. The function structures created through the FCs function modelling approach have a common representation and understanding and are formalised on the function block level. It can be argued that FCs simplify the process of creating a function structure by providing a template for each function, and designers build the function structure by adding FCs that best describe the intended function. Once added to the function structure, FC already has defined inputs and output flows, conforming to primary rules. The final function structure is created by connecting FCs and checking modelling rules. While this approach somewhat limits the designer's freedom in expressing functions, it ensures a uniform graphical representation with defined meaning for each function, thus simplifying the sharing and understanding of function structure among various participants of the design process. Furthermore, class descriptions of function blocks will support computational design activities. In total, 45 FCs are derived and presented in Appendix B.2.

4.2.4 Modelling Rules

As the FCs formalise function structure only on the function block level, the formal syntax is needed to support the arrangement of FCs inside the function structures. The syntax is formalised in a set of modelling rules that define relations between function blocks and how the function chains are created (Appendix B.3). The main purpose of the modelling rules is to guide designers in the process of creating a function structure to apply the FCs properly and arrange them in a function structure to create an expressive combination of function chains and the entire function structure.

The first part of the rules defines relations between function blocks and flows (Rules #1 – #4). For example, the flow (arrow) cannot have a dangling end. Both the tail and head must always connect to a function block or system boundary node. The second part of the rules provides guidance for modelling carrier-carried flows (Rules #5 – #8). These rules define that when carrier-carried flows are modelled, they can enter the system in carrier-carried relation, continue in this relationship throughout the function chain, or be separated inside the system on independent flows. Also, two independent flows can be joined inside the system into a carrier-carried relation.

The rules also impose certain prerequisites for each function structure, such as the use of import and export functions for interaction with the environment (Rule #9), but also restrictions on function modelling to avoid creating unfeasible combinations (Rule #10). The final two rules (Rules #11 and #12) suggest how relations among function chains should be modelled.

4.3 Mapping Method

The mapping process inside the proposed methodology is enabled through the Mapping Method. The Mapping Method uses MRs to map the function structures of a product and AM DPs. The mapping process creates an MFP Structure that represents an abstract product layout and enables the generation of concepts that utilise the AM possibilities. It provides a systematic exploration of AM design space by suggesting AM DPs that could be used to create a possible solution for fulfilling individual functions or block of functions.

The Mapping Method's framework is made of six steps and is shown in Figure 4.8. The input to the method is the function structure that must be compliant with the FC approach. The first step of the method is to identify or choose a function block from which the mapping process will start. The selection depends on the designer conducting the mapping. As a starting function block, the designer can choose the function block they think is the most important one, choose the first function block on the main function chain, choose the function block randomly, or use some other strategy they think is appropriate. In the second step, all possible MRs applicable for the chosen function block are detected together with DPs that can be used as a solution for each rule. The designer must carefully review the suggested MRs and DPs. After reviewing all possible MRs, the designer chooses MR and DP to be applied (step three). Alternatively, if MRs and DPs suggested are not applicable or no MR is found, the designer can leave the function block unmapped and start the mapping process with a different starting block. Once the MR is chosen, the function block or blocks to which MR refer are marked together with the complementary DP. The process is repeated until all functions are mapped (or purposely left unmapped), and a Mapped-Function-Principle Structure (MFP Structure) is created. MFP Structure is a graphical representation showing all applied MRs and DPs on a function structure. It represents an abstract layout of the product in terms of DPs applied to solve its functions similarly to a systematic combination inside the morphological matrix [18].

After the first MFP Structure is created, the designer should create alternative MFP Structures with different combinations of MRs and DPs applied to fully explore the AM-enabled design space. Each created MFPS will be a foundation for the potential concept of an AM product.

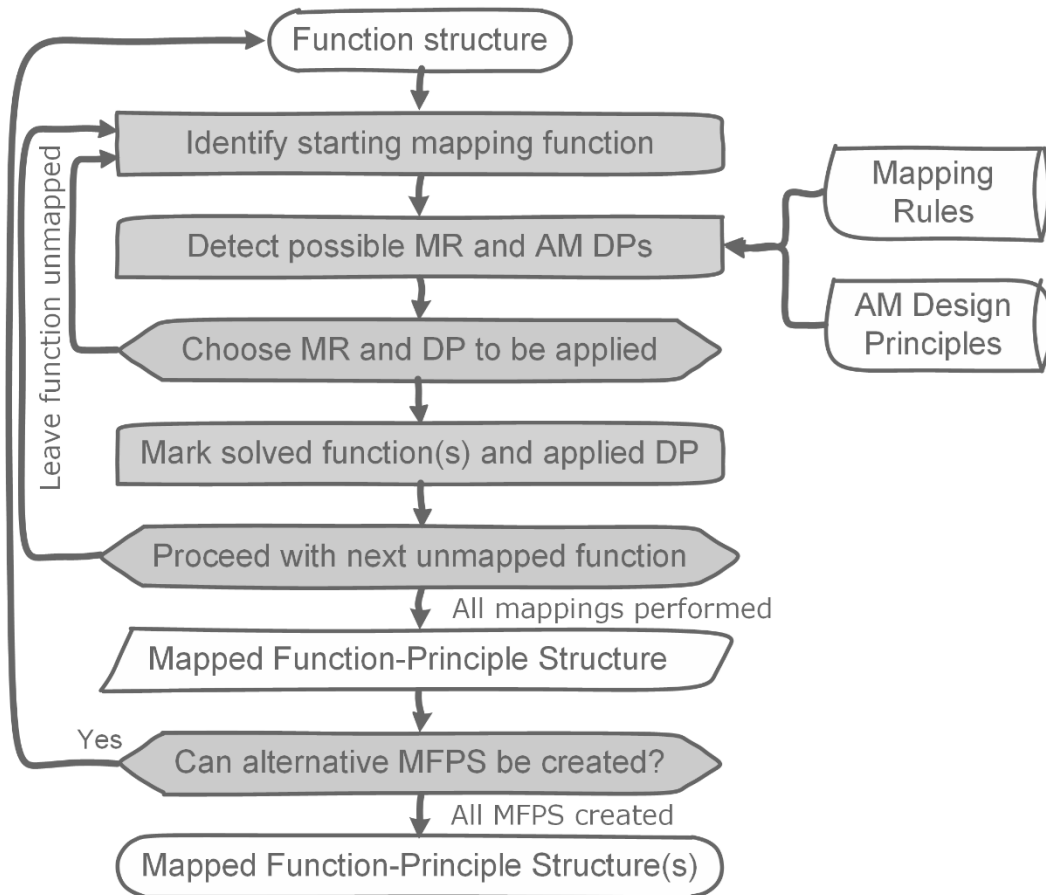

Figure 4.8 Mapping Method's framework

4.3.1 Mapping Rules

The form-to-function relations observed and extracted in the empirical study (Section 3.5) capture the relationships between product functions and AM forms used to solve them. By matching product functions and AM DPs, a set of Mapping Rules (MRs) is constructed. The MRs describe how product functions can be solved using the AM DPs and are a backbone of the mapping methodology.

The MRs are formalised in a set of 42 rules, containing design knowledge for performing mapping in new product development of AM products. The MRs are formulated to allow an open-end formulation and not only a one-to-one match between product functions and AM DPs. Such formulation enables the mapping of one or more function blocks to one or more DPs simultaneously, which is necessary for achieving a function integration by solving two or more functions with a single solution and encouraging innovations by allowing multiple combinations of AM DPs. The derived set is made of three types of rules: block rules (23 rules), flow rules (3 rules) and individual function rules (16 rules). Each MR is defined with a name, a short description of the rule, a graphical example and a list of DPs that can be used to solve the MR. The list of MRs is presented in Appendix D.

The block rules are the largest subset of derived MRs. They are used for mapping two or more individual function blocks with AM DPs. Table 4.1 shows two examples of block rules. The first example is the MR “*Transfer of ME onto Surface*”. The rule is used when a block of three functions is encountered (*Import Surface*, *Transfer ME* and *Export Surface*) that are used to represent the interaction of the system with the environment and transfer of ME or reaction forces onto the surface (e.g., running shoe sole embodies these three functions). When the rule is applied, the three functions are mapped as a single block with one of the three suggested DPs (#DP4, #DP5 or #DP7). While this rule uses three specific functions, the following example of the rule is more universal in its definition. The rule “*Transfer of TE on Fluid*” is made of function *Transfer TE*, which must be accompanied by the function *Guide* or *Distribute* or both (e.g., cooling channels embody these functions). The functions can operate on the flow of *Gas* or *Liquid*. Such definition of the rule enables broader application in the mapping process and limits the number of derived MRs, as otherwise 6 rules would be required to describe every possible combination of functions and flows contained in this rule. However, the designer who applies the MRs must carefully observe that rule applies to the given context, and all functions contained are then mapped with a DPs (#DP9 or #DP24).

Table 4.4 Example of function blocks MRs

Code	Name of the mapping rule	Possible mappings with DP
Textual Definition/ Graphical Definition		
BR-CH1	Transfer of ME onto Surface	#DP4, #DP5, #DP7
Block of functions used for transferring mechanical energy onto the surface to ensure grip and transfer of reaction forces. It consists of functions <i>Import Surface</i> (IMP M1), <i>Transfer ME</i> (TRA E1) and <i>Export Surface</i> (EXP M2).		
BR-CH2	Transfer of TE on Fluid	#DP9, #DP24
Block of functions used for cooling capability of the system. It consists of functions <i>Guide</i> (GUI M1) and/or <i>Distribute</i> (DIS M1) that operate on the flow of <i>Liquid</i> or <i>Gas</i> , and function <i>Transfer TE</i> (TRA E1).		

4. Mapping Methodology

The next type of rules are flow rules. Flow rules do not focus on the function blocks but rather on the particular flow. Flow rules map all the function blocks through which a flow passes as a single block. Only three such rules are derived that operate on the flow of *Acoustic Energy*, *Human Material/Energy* and *Electromagnetic Energy*. Table 4.5 shows an example of the flow rule. The rule “Management of acoustic energy” is used on the flow of *Acoustic Energy*, and all function blocks through which it passes are mapped as a single block.

Table 4.5 Example of flow MRs

Code	Name of the mapping rule	Possible mappings with DP
Textual Definition		
Graphical Definition		
FR-AE	Management of acoustic energy	#DP11
Function chain for management of a flow of acoustic energy. It is made of all functions operating on the flow of <i>acoustic energy</i> (AE).		

The final subset of MRs are individual function rules. These rules are used for mapping a single function block and a DP. Table 4.6 shows two such rules. The first example is the rule “*Change Light*” that maps function *Change EME* with #DP27. The second example is the rule “*Export Liquid*”. This rule maps function *Export Liquid* (expressed through FC EXP M1 or EXP M2, depending on whether the liquid is an energy flow carrier or not) with #DP6 or #DP17.

Table 4.6 Examples of individual function MRs

Name	Graphic
Description	
Function(s)	
Possible Mapping	
Change Light	
Function used for changing the permutability of light.	
CHA E1 EME	
#DP27	
Export Liquid	
Function used for exporting liquid (and the carried energy) from the system.	
EXP M1 Liquid, EXP M2 Liquid	
#DP6, #DP17	

| 4.3.2 Design Principles for AM

This section is based on the journal paper [161].

The AMK extracted through empirical research (Section 3.4) is formalised in the form of AM Design Principles (DPs). DPs, together with design heuristics and design guidelines, are one of the most common forms of knowledge explications used to codify and formalise design knowledge [49]. The design principle is defined as: “*A fundamental rule or law, derived inductively from extensive experience and/or empirical evidence, which provides design process guidance to increase the chance of reaching a successful solution*” [49]. When compared to design heuristics, DPs, are less context-dependent and are based on empirical evidence rather than tacit knowledge. While in comparison with design guidelines, DPs provide more specific instructions rather than context-dependent directives.

DPs must clearly articulate the intended meaning of AMK stored in them. Two main formats for articulating DPs are prescriptive and descriptive formats. The prescriptive format is stated in the imperative grammatical form and prescribes an action designer must take. On the other hand, the descriptive format is stated in grammatical declarative form, and it informs the designer about the concept, fact, or knowledge to be applied in the given context [49]. If the existing sources of AMK for early design phases are reviewed, crowdsourced AM design principles are defined using the prescriptive format [48,103], while AM design heuristics are defined in descriptive format [14,47]. Because the mapping methodology developed in this thesis proposes AM solutions on how to solve a particular product function or block of functions, an imperative form with clearly stated action the designer should take will be used. This type of form is also recommended as an adequate form for defining DPs [49].

To clearly represent the DPs, the AMK and their intention, a syntax proposed by Lauff et al. [104] is adopted with smaller modifications to better reflect the function-oriented nature of the derived DPs. The syntax firstly states a design problem or requirement, followed by the conjunctive “by” and a generalised action to address the design problem. The syntax can be stated as:

SOLVE DESIGN PROBLEM “Y” by USING “X” AM CHARACTERISTIC.

Table 4.7 shows two examples of derived and formulated DPs. Each principle is defined with a statement in an imperative form following the prescribed syntax and accompanied by a short description explaining the AM possibility and intended action. In #DP1 the design problem is how to fit the user, associated with the flows of *Human Material* and *Human Energy* through the system. The suggested solution is the use of custom-made geometry to ensure

4. Mapping Methodology

ergonomic interfaces for the user. In #DP12, the functions *Guide* and *Distribute Mechanical Energy* are solved with the use of lattice structure geometry.

Table 4.7 Example of DPs

#	Design Principle
#DP1	Fit user by using custom ergonomic geometry AM enables manufacturing of complex and curved geometry. Furthermore, each product manufactured with AM can have different geometry. Therefore, the geometry in interaction with the user can be easily customised for an individual user or different groups of users to provide an optimum ergonomic.
#DP12	Conduct mechanical energy and forces by applying lattice structures AM enables easy manufacturing of lattice structures, on multiple levels of hierarchy, through the entire geometry or only in part of the geometry. Use the lattice structures to conduct mechanical energy through the product and create a lightweight but stiff product.

Furthermore, as AM features can be used to solve multiple different functions, the syntax avoided mentioning functions in DP definitions but rather used a general description of the design problem referring to multiple functions. Formulating DPs to include a declaration of a particular function in syntax would lead to the extensive expansion of the number of DPs, which would be exhausting to comprehend with little additional value to the stored AMK. Similarly, a lack of reference to specific materials and AM technologies gives universality to the derived DPs and emphasises their focus on early design phases. In the end, from the pool of 45 products, 32 principles are derived, and the complete list is given in Appendix C.

5

Computational Prototype Framework

Chapter 5 is the second part of the Prescriptive Study. The chapter describes the developed computational prototype framework, software support for the Mapping Methodology and its parts. The developed computational prototype framework is named the Function Mapping Application. The chapter firstly describes the architecture of the computational prototype framework and continues with the description of its operating modes.

To use the Mapping Methodology, the designer must be familiar with the FCs, DPs, and MRs. Due to the sheer size of information contained in these elements of the Mapping Methodology, applying the methodology using a pen & paper approach could be troublesome. Designers would have to search through lists of FCs, DPs, and MRs frequently. This would require a significant amount of time and increases the possibility of error in the search and application of the FCs, DPs, or MRs. Therefore, a computational prototype framework is developed as a software design tool for Mapping Methodology to address these issues. The use case of the FM App can be seen in Appendix A.

5.1 FM App Architecture

The computational prototype framework developed as part of this research is named the Function Mapping Application, FM App for short. The FM App provides support for function modelling and mapping processes using the developed Mapping Methodology. It is developed as a macro for Microsoft Visio, a diagramming and vector graphics application [167], written in the Visual Basic for Application (VBA) language. The FM App architecture is made of five parts (Figure 5.1):

- MS Visio,
- FMApp Stencil [OPC/XML stencil, macro-enabled document (.vssm)],
- MS Excel Workbook (.xlsx),
- Visio Drawing [OPC/XML drawing (.vsdx)],
- XML (Extensible Markup Language) document (.xml).

5. Computational Prototype Framework

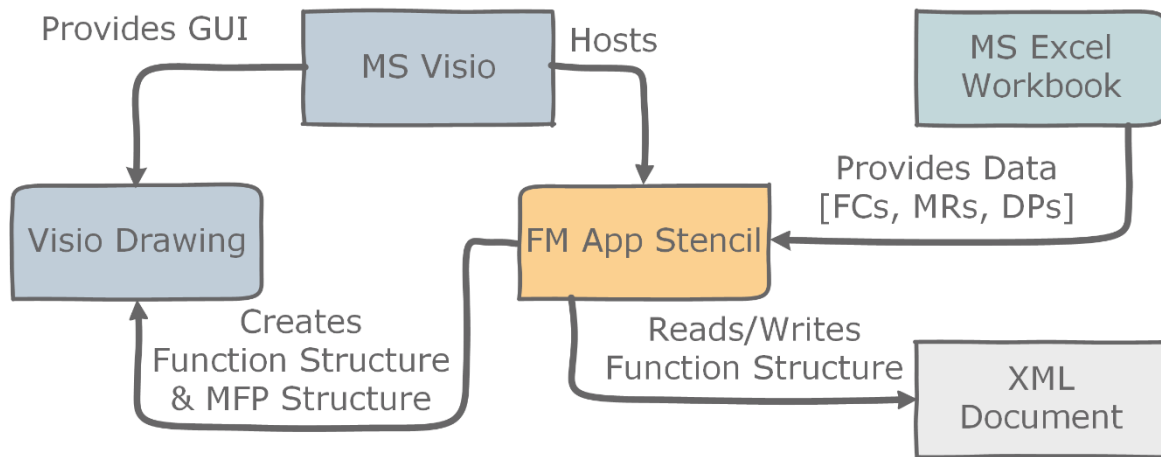

Figure 5.1 FM App Architecture

The first part of FM App architecture is an MS Visio, a host application that provides a Graphical User Interface (GUI) for creating function structures and MFP Structures. The structures are made on canvas using the MS premade stencil shapes objects (Figure 5.2) hosted in the FM App Stencil document and MS Visio GUI to manipulate the graphical objects. Furthermore, MS Visio is a host application for VBA that enables the creation of user-defined functions to automate the processes of function modelling and mapping. It provides the Integrated Development Environment (IDE) in which VBA code is running. The VBA code is created in an event-driven manner and is run when the user creates a graphical object using a stencil or uses a VBA User Form.

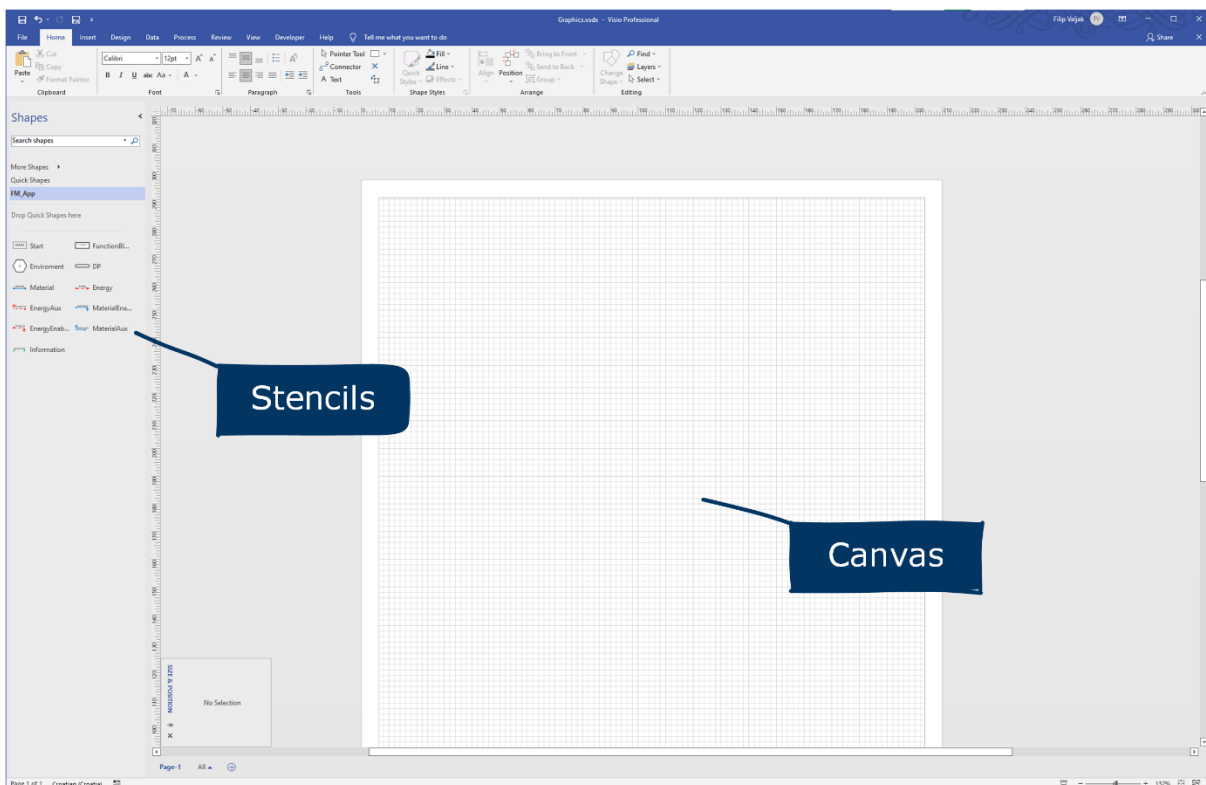

Figure 5.2 MS Visio with loaded FM App Stencil (FM_App.vsmm)

The second part of FM App architecture is an FM App Stencil. It is a macro-enabled document that contains stencil shape objects, VBA code and VBA User Forms. The stencil shape objects (Figure 5.3) are used for the graphical representation of function blocks, environment nodes, flows and MR-DP blocks that make a function structure and MFP Structure. The stencil objects are divided into two groups. The first group is made of three objects that the user drags and drops onto the canvas. These are the Start Stencil, a temporary object used for starting the FM App, and Function Block and Environment Stencil objects that the user needs to drag and drop onto the canvas to create a node element of the function structure. Other stencil objects (Flow Stencils and DP Stencil) are not placed on the canvas by the user but are automatically added when appropriate VBA code is run.

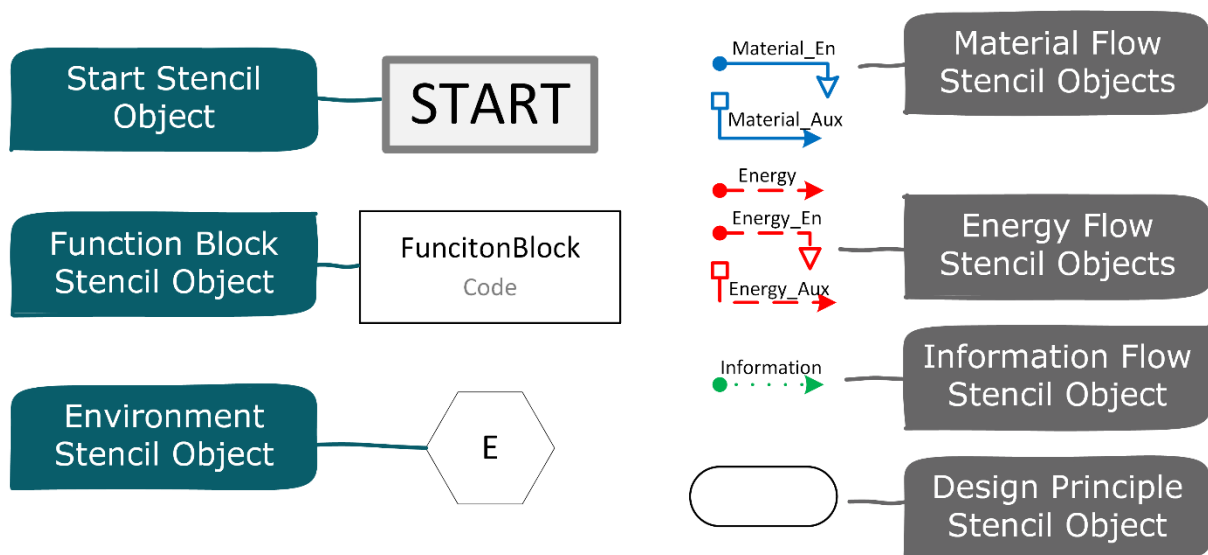

Figure 5.3 Stencil Objects

VBA code is organised in four modules and five user forms that enable the creation of function blocks, connecting of functions to create function structure and application of MRs to create MFP Structure.

- **General Module:** The module contains global variables, VBA code and functions that are needed by other modules and forms.
- **Excel Module:** The module contains VBA code needed for accessing the Excel Workbook where data about FCs, DPs and MRs are stored. Its code reads the Workbook and provides data for other modules and forms.
- **XML Module:** Its code creates, reads, and edits the XML document where data about the created function structure is stored.
- **Start User Form:** The form (Figure 5.4) provides basic instructions for the user and enables the user to use functions for connecting flows and deleting function blocks,

as well as to start mapping mode. Its code provides the initialisation of the FM App and the background processes such as loading MS Excel Workbook and XML document.

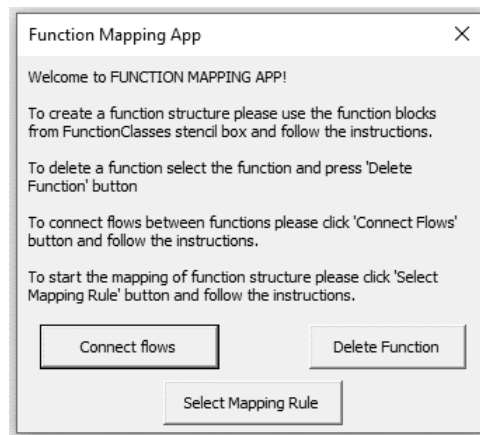

Figure 5.4 Start User Form

- **Function Block Module & Function Block Form:** The Function Block form is invoked when Function Block Stencil is placed on a canvas. The user form (Figure 5.5) enables the user to choose the FC and define its interacting flows. The VBA code stored in the Function Block module reads the FCs data stored in the database and checks if the user selected the correct flows. Once the user defines the FC, the VBA code creates the graphical representation on canvas with all its input and output flows using the appropriate stencil objects for flows and filling the description texts.

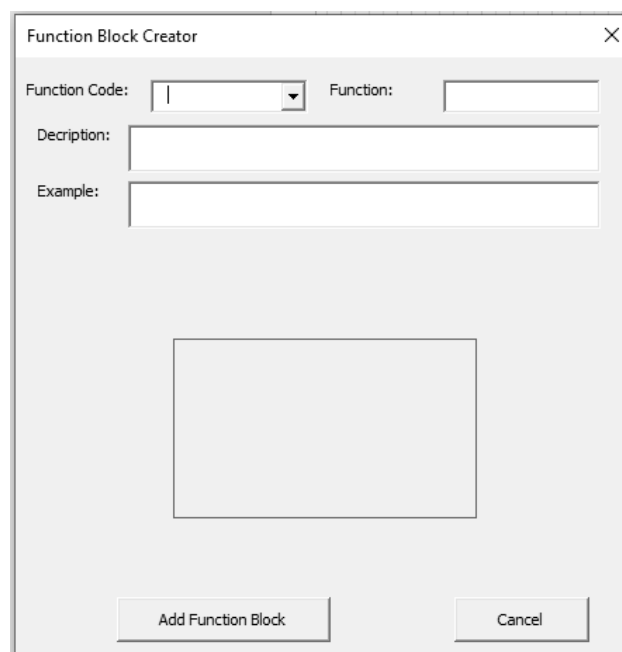

Figure 5.5 Function Block Form

- Mapping Form: The user form (Figure 5.6) enables the designer to view the MRs and DPs and choose which one to apply. The code checks which MRs are possible for the given function blocks and makes the markings on MFP Structure once the user confirms the selected MR and DP.

The screenshot shows a window titled "Mapping" with a close button (X) in the top right corner. Inside the window, there is a "Search Rules" button and a text instruction: "Please select single function block and click Search Rule button to begin the search". Below this, there are two columns of input fields. The left column is labeled "Selected function block can be mapped with following mapping rules;" and contains two empty text boxes. The right column is labeled "Chose Design Principle:" and contains a dropdown menu. Below these columns is a large empty rectangular area. At the bottom of the window, there is an "Instructions:" label above another empty text box. At the very bottom, there are three elements: a dropdown menu currently showing "Red", a "MAP" button, and a "DoubleMap" button.

Figure 5.6 Mapping form

- Double Rule Form: This form (Figure 5.7) and its code enable the user to make a double mapping of the function block when it is simultaneously mapped with two MRs and DPs.

The screenshot shows a window titled "Double Rule Mapping" with a close button (X) in the top right corner. Inside the window, there is a text instruction: "Please select a function block on which two rules are applied. Choose the two colours of already mapped functions and click button MAP!". Below this instruction, there are two dropdown menus: the first one is currently showing "Red" and the second one is currently showing "Blue". At the bottom center of the window, there is a "MAP" button.

Figure 5.7 Double Rule form

5. Computational Prototype Framework

- **Connect Flows form:** This form is used for connecting function blocks with appropriate flows. The form shows basic instructions to the user (Figure 5.8), and its VBA code checks if the connecting flows user has selected follow the modelling rules and notify the user if the connection is not compliant and why.

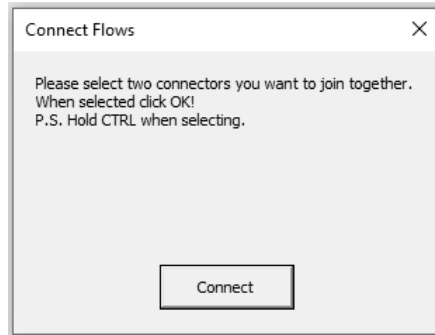

Figure 5.8 Connect Flows Form

The third part of the FM App architecture is an MS Excel Workbook that acts as a database of FCs, DPs, MRs, and relations between them. The VBA code, through the Excel module, access the Excel Workbook to read data about the user-selected FC, or possible MRs and DPs for a given function. All the data is stored in multiple tables (Figure 5.9) to capture the definitions FCs, MRs, DPs, and the relations between them,

	A	B	C	D	E	F	G	H	I
1	Code	Function	Description	Example	Operating Flow	InFlow1	OutFlow1	InCarried1	OutCarried1
2	SEP M1	Seperate	Separating r	Bottle oper	Material	EqualOF1	Material		
3	DIS E1	Distribute	Distributing	Lens distril	Energy	EqualOF1	EqualOF1		
4	DIS E2	Distribute	Distributing	In a cherry j	Energy	EqualOF1	EqualOF1		
5	DIS M1	Distribute	Distributing	Internal che	Material	EqualOF1	EqualOF1		
6	DIS M2	Distribute	Distributing	Fuel injectc	Material	EqualOF1	EqualOF1	Energy	EqualInCarrie
7	IMP E1	Import	Import ener	Handle on t	Energy	EqualOF1	EqualOF1		
8	IMP M1	Import	Import mate	Pneumatic	Material	EqualOF1	EqualOF1		
9	IMP M2	Import	Import mate	Pneumatic	Material	EqualOF1	EqualOF1	Energy	EqualInCarrie
10	IMP M3	Import	Import mate	Push-butto	Material	EqualOF1	EqualOF1	Energy	

	A	B	C	D	E	F	G	H	I	J	K	L	M	N	O	P	Q	R	S	T	U	V	W	X	Y
1		DP1	DP2	DP3	DP4	DP5	DP6	DP7	DP8	DP9	DP10	DP11	DP12	DP13	DP14	DP15	DP16	DP17	DP18	DP19	DP20	DP21	DP22	DP23	DP24
2	BR-CH1			x	x		x																		
3	BR-CH2									x															x
4	BR-CH3																		x						x
5	BR-CH4																								x
6	BR-CH5					x	x																		
7	BR-CH6									x															

Figure 5.9 Excel Workbook Example

The fourth part of the FM App architecture is a Visio drawing document. It is user created document in which a graphical representation of function structure and MFP Structure are stored.

The fifth part of the FM App architecture is an XML document. It is a textual record of created function structure. In an XML document, each created function block is written as a separate XML node that contains information describing the function block (Figure 5.10). It

contains information regarding FC and defined flows but also information for identifying the graphical elements on the canvas.

```

▼<FunctionStructure>
  ▼<FunctionBlock FBID="FunctionBlock">
    <FBCode>TRA E2</FBCode>
    <OpFlow1>ME</OpFlow1>
    <InFlow1 FlowID="Energy" Point="0">ME</InFlow1>
    <OutFlow1 FlowID="Material" Point="6">Solid</OutFlow1>
    <OutCarriedFlow1 FlowID="Energy.5" Point="9">ME</OutCarriedFlow1>
    <EnablingFlow FlowID="MaterialEnabling" Point="11">Solid</EnablingFlow>
    <AuxFlow FlowID="EnergyAux" Point="10">TE</AuxFlow>
  </FunctionBlock>
  ▼<FunctionBlock FBID="FunctionBlock.9">
    <FBCode>EXP M2</FBCode>
    <OpFlow1>Solid</OpFlow1>
    <InFlow1 FlowID="Material.10" Point="4">Solid</InFlow1>
    <OutFlow1 FlowID="Material.11" Point="6">Solid</OutFlow1>
    <InCarriedFlow1 FlowID="Energy.12" Point="5">ME</InCarriedFlow1>
    <OutCarriedFlow1 FlowID="Energy.13" Point="9">ME</OutCarriedFlow1>
  </FunctionBlock>
</FunctionStructure>

```

Figure 5.10 Example of Function Block record in an XML File

5.2 FM App Modes of Operation

The FM App has two modes of operation – as a tool for creating function structure and as a tool for mapping function structure and DPs. In both cases, the users firstly must start the MS Visio, load the FM App Stencil, and start the FM App. The FM App is started by dragging and dropping the Start Stencil on the Visio canvas. At that moment, the initialisation of the FM App is conducted. This includes background opening of the Excel Workbook and loading of the XML document of a function structure or creating a new one if none exists (Figure 5.11).

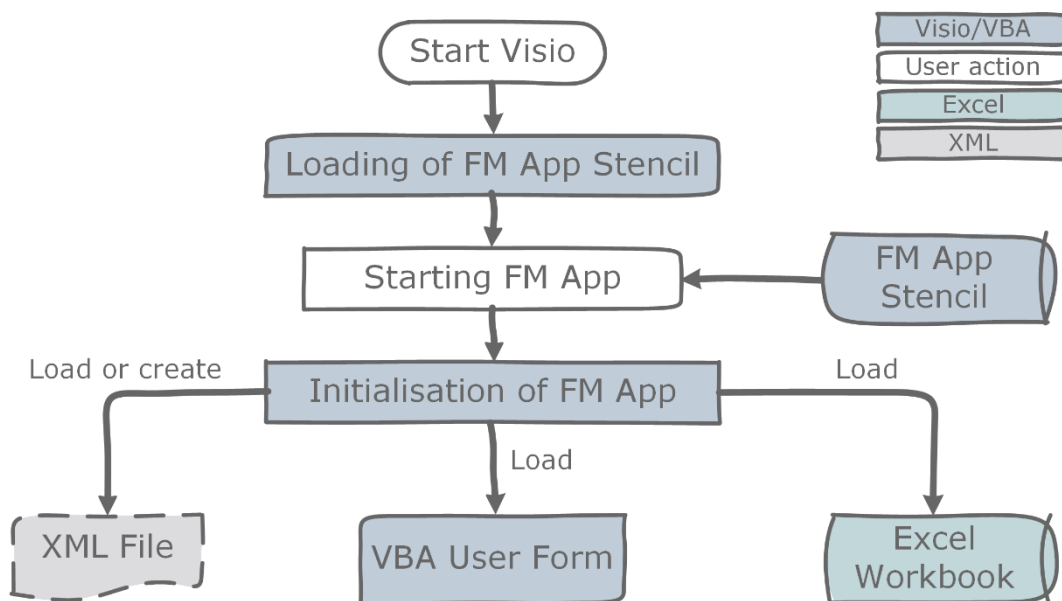

Figure 5.11 FM App Initialisation process

5.2.1 Function Modelling

Once the FM App is started, the process of creating a function structure is based on the workflow for defining individual function blocks (Figure 5.12) and once the individual functions are added and defined connecting them into an overall function structure.

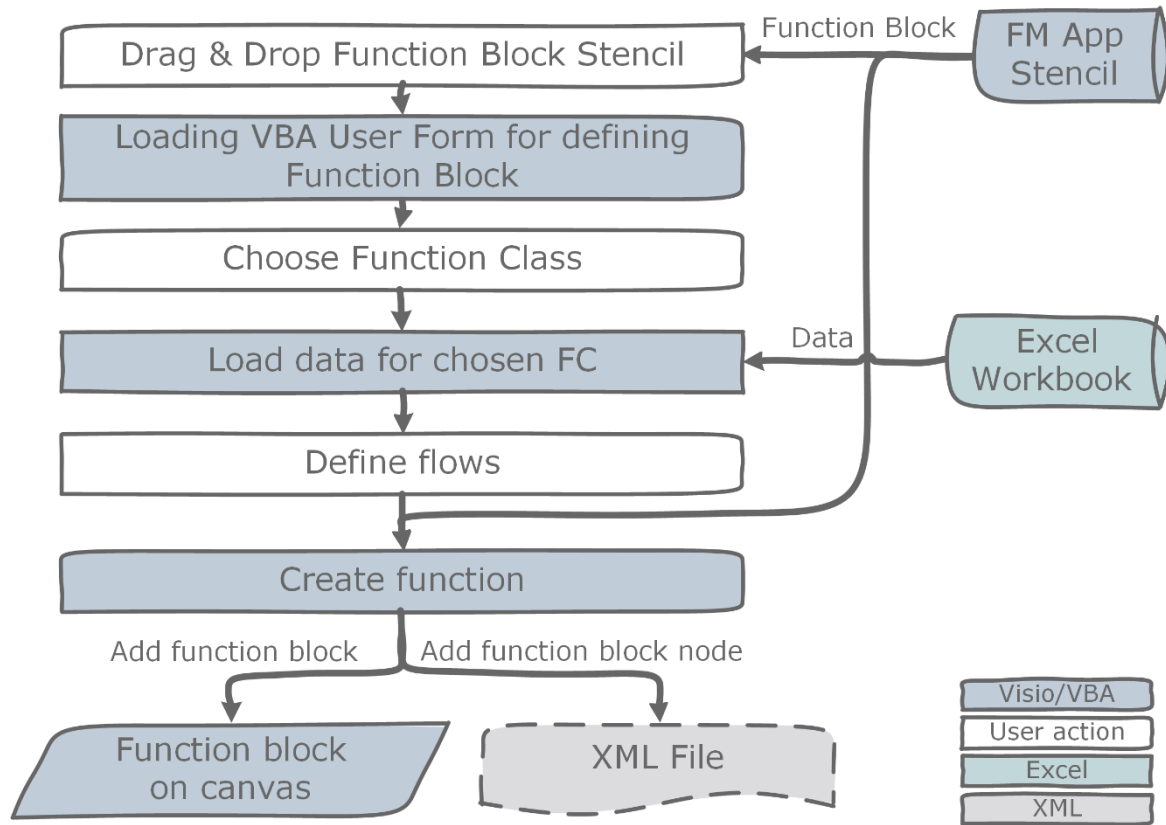

Figure 5.12 Workflow for creating Function Block using FM App

The process of creating a function block starts with a designer dragging and dropping the Function Block stencil onto the canvas. This action loads a VBA User Form for choosing FC (Figure 5.13). The designer selects the FC they want to apply using the drop-down menu. Once the FC is chosen, the FM App loads the definition of the chosen FC from the Excel Workbook. It displays the information about the FC (textual description and image) and configures the menus for selecting the flows associated with the FC. First, the designer must choose the operating flow using the drop-down menu. If the input and output flows are not equal to the operating flow, the designer must choose them as well. Then, the designer confirms the FC using Add button, and the FM App adds appropriate flows (from stencil object) and text to the function block on the canvas and writes the data in the XML file as a node. The process is repeated until all function blocks are added.

Using the Connect Flows function, the designer connects flows between two function blocks by selecting the input flow of one block and the output flow of the other. Then, the FM App

checks the appropriate connection is made, and it connects the flows on canvas and updates the appropriate nodes in the XML file of the function structure.

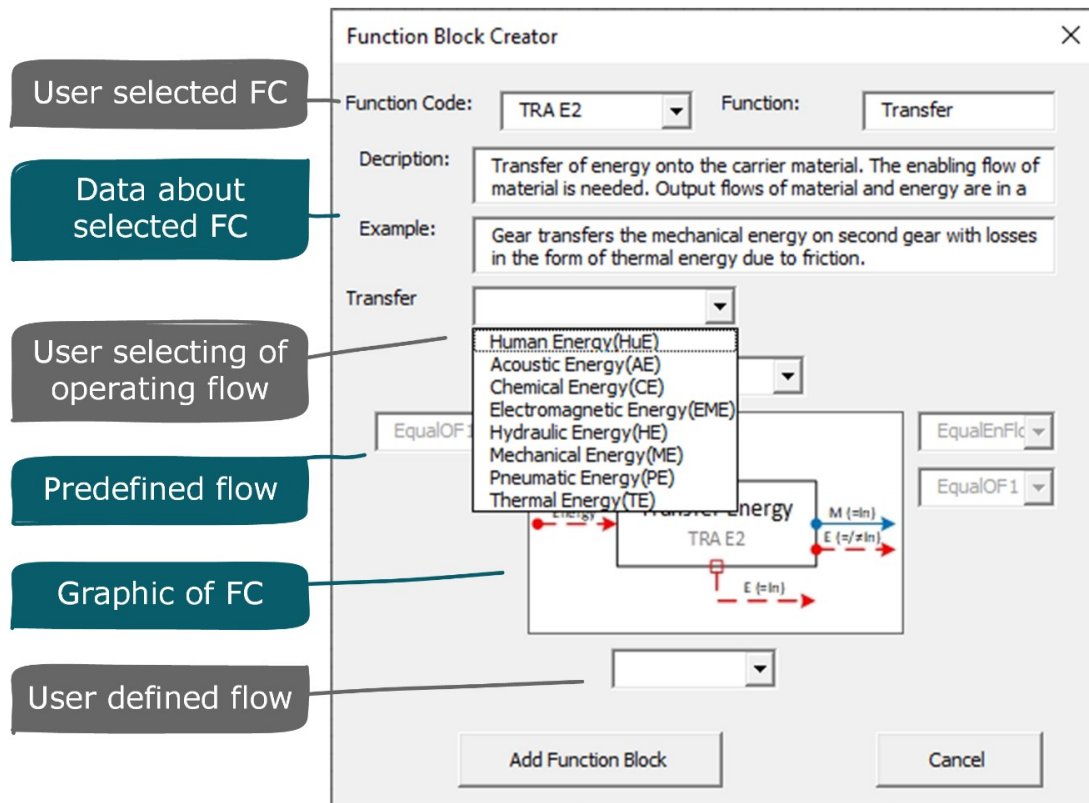

Figure 5.13 Function Block Creator VBA User Form

5.2.2 Function Mapping

Once the function structure is created, a mapping process can be started (Figure 5.14) using the second mode of operation. To map a function structure designer must start the VBA User Form for the mapping process, select a function block from which they want to start the mapping process and begin the search (Figure 5.15). The FM App reads the FC information from the XML file for the selected function block and searches the possible MRs for the selected function in an Excel Workbook. All possible rules are displayed to the designer in a drop-down menu. The designer must review the rules, choose the rules they want to apply, manually select the rest of the functions if necessary, and choose the DPs that would be mapped with the selected MRs. Once the “Map” button is pressed, the FM App marks the function blocks with the designer’s choice of colour and adds the text box in which the information about the MRs and DPs are stated. By repeating the steps for all functions, the MFP Structure is created.

The additional functions of the FM App are functions for deleting function block and double mapping. The former is used for removing unwanted function block both from canvas and XML file, while the latter is used to colour the function block in two colours in a case where two MRs or DPs are applied simultaneously.

5. Computational Prototype Framework

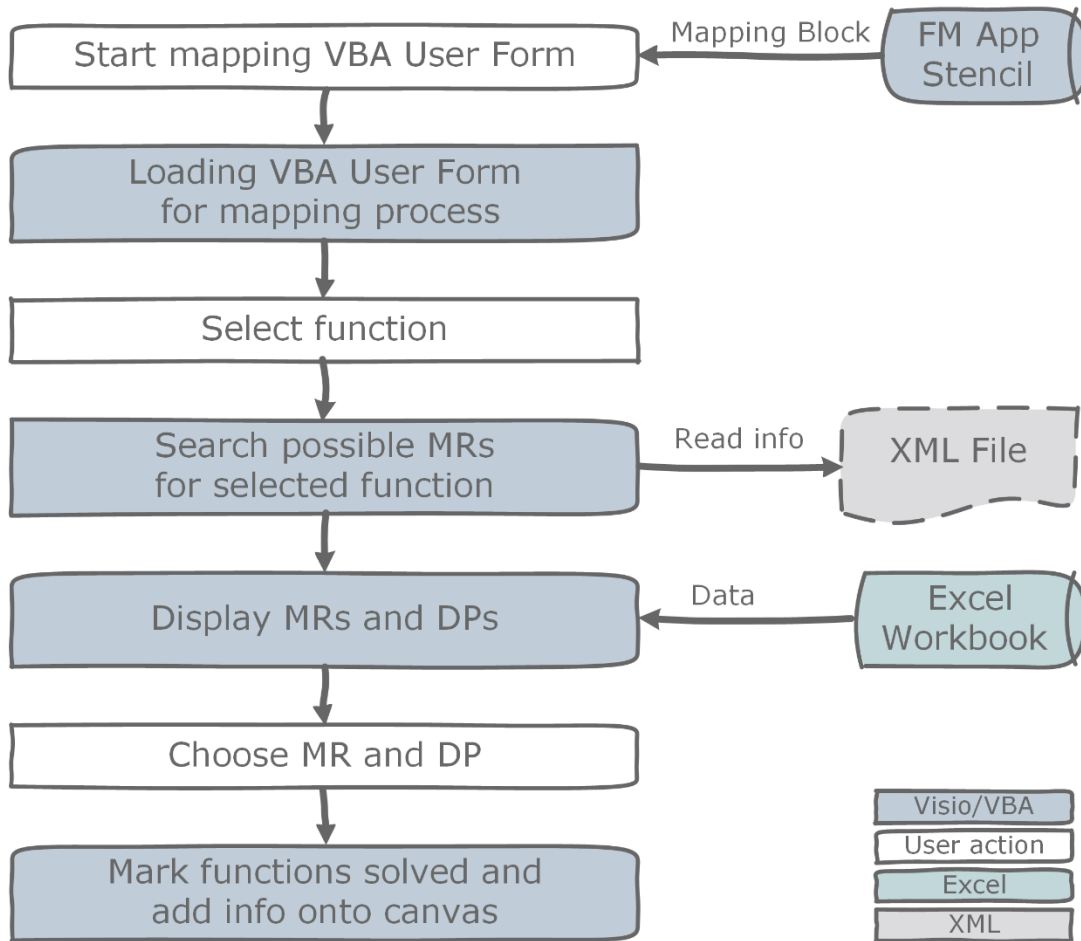

Figure 5.14 Workflow for creating mapping process using FM App

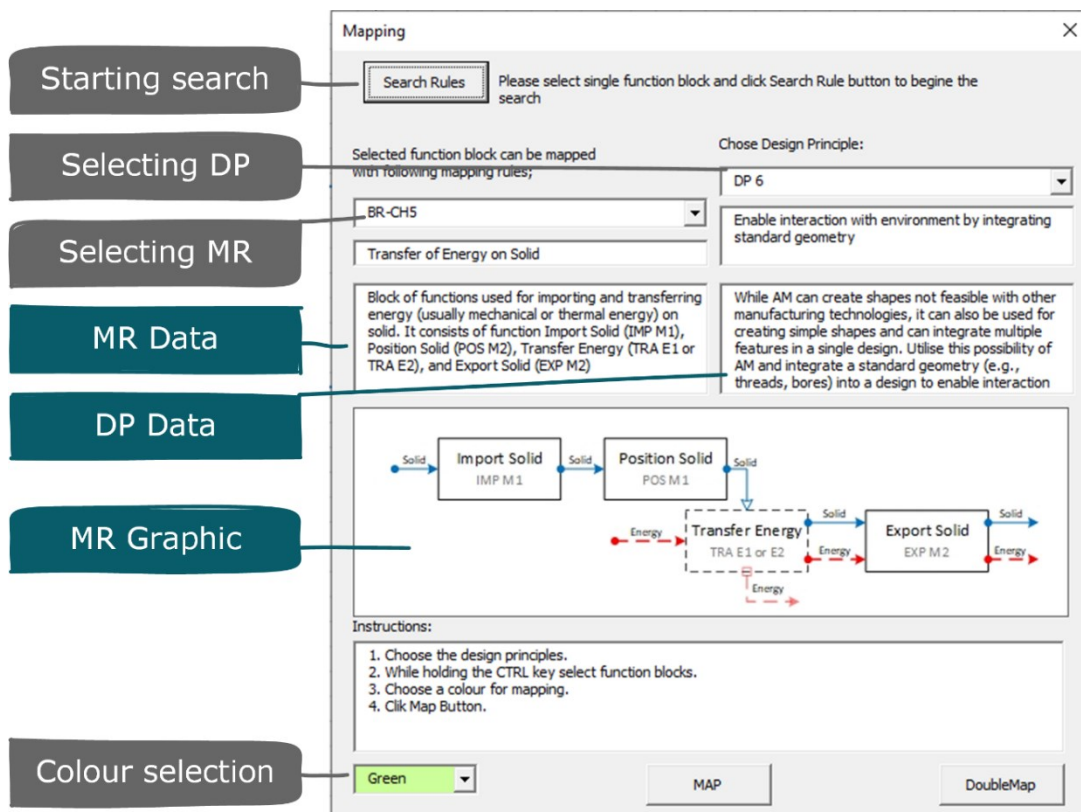

Figure 5.15 Mapping process VBA User Form

6

Case Study Design

Chapter 6 is the first part of Descriptive Study II. This chapter presents the background of the case study research. The chapter starts with the overview of case study research and the rationale why it is used to validate the Mapping Methodology. Then the case study design is presented, including the definition of the case study question, propositions, units of analysis, and criteria for selecting cases. Finally, the chapter ends with the development of protocols for data gathering, data analysis and selection of cases.

| 6.1 Overview of case study research

Design research is a highly interdisciplinary field of science with influences from many other fields of science like engineering science, economics, psychology, or sociology [168]. For design research results to be valid and considered scientific, design research must use systematic methods to validate knowledge [169]. The interdisciplinarity of design research led to the implementation of validation methods from other science fields, most notably from social sciences, to formulate and verify hypotheses [169]. One such method is a case study method, a common method in social sciences that has been applied in many scientific fields due to its flexibility, applicability, and ease of use. For these reasons, it is also used as a method of inquiry in design research to generate a hypothesis, analyse a phenomenon, or validate design support methods [55,168–171].

The case study is an empirical research method for investigating a contemporary phenomenon within its real-life context using multiple sources of evidence [168,172]. While case study as a research method had a stigma of being improper, invalid, and invaluable [172,173], with the development of case study research methodology, with clearly defined protocols and a systematic approach for conducting the research, the stigma has been removed. Therefore, if properly conducted, a case study is a valuable research method [168,172–174].

The case study is an empirical research method used to gather and analyse both quantitative and qualitative data [173,174]. It provides an opportunity for a researcher to investigate or describe a phenomenon, collect data, and conduct data analysis in a real-life context by using various data sources rather than a laboratory setup. Such an approach enables testing a range of variables in a single study [172,175]. The case study method is based on the replication logic rather than sample logic and does not aim to control or manipulate the variables but intends to

6. Case Study Design

gather data without the influence or control over the environment [172]. The use of replication logic enables the generalisation of conclusions from the small sample of investigated cases. Because the generalisation is made with a small sample, case study research attempts to use multiple sources of evidence and data triangulation through various methods and techniques to validate the results [176]. The supporting data is crucial for argumentation.

The case study research is a linear but iterative process made of six different phases [168,172] (Figure 6.1). The researcher wanting to conduct the case study research must first identify and evaluate a relevant situation for undertaking a case study and compare it with other methods of inquiry. Once the case study is identified as an appropriate research method for a given context, it must be designed. The design phase includes a definition of a case or cases, development of theory and definition of propositions. Furthermore, the design must be tested for validity to maintain the quality of the case study. Next, the case study protocols for data gathering and analysis are developed in the preparation phase. Moreover, the general strategy and analytic techniques are selected, and argumentations for rival explanations are considered. The fourth phase of conducting the case study is data collection. It is advisable to use multiple sources of evidence and create a case study database as a formal repository of evidence, independent from the final report, containing raw data. In the collection phase, the emphasis must be on maintaining the chain of evidence. After the data is collected, it must be analysed. Here, different procedures can be used, such as examining, categorising, or recombining evidence in combination with one or more analytic strategies defined in the design and preparation phases. The goal is to “play” with data and attend to all collected evidence, addressing the research questions, propositions, and rival theories. Finally, the case study research is concluded by sharing the conclusions drawn from the research. Regardless of the form in which the case study results are presented, it is essential to form the report for the intended audience and show enough evidence for a reader to make their own conclusions. [172]

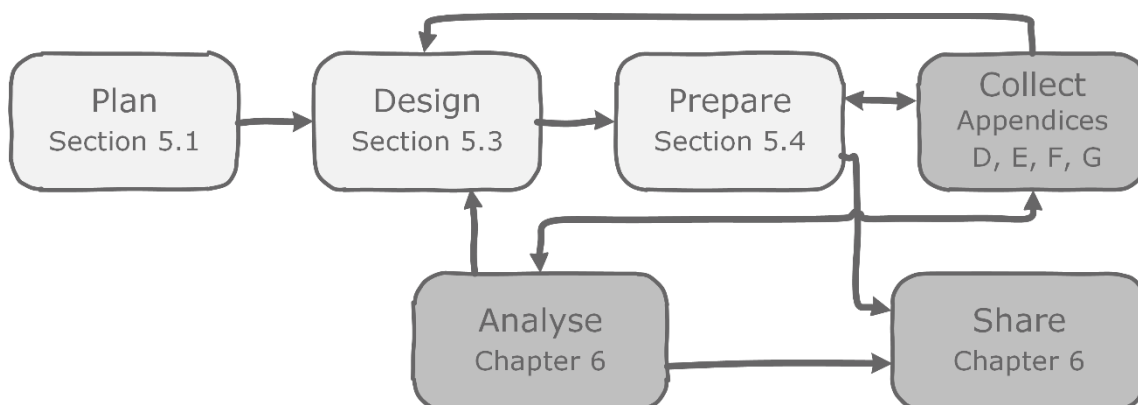

Figure 6.1 Phases of the Case Study research [172]

| 6.2 Rationale for using validation case studies

A design methodology is considered valid if its usefulness for the specific intended purpose could be proven [55]. To validate a methodology, a number of different qualitative and quantitative research methods can be used, such as experiments, surveys, observations, and among others, case study research. The case study is a comprehensive method appropriate for investigating situations where the phenomenon is not distinct from the context [168]. It allows testing the hypothesis in a real-life context where many variables, including the environment, cannot be controlled. The characteristics of a case study research method make it suitable for validating the proposed Mapping Methodology. Firstly, the case study is focused on the phenomenon (e.g., activity, particular event) rather than on individual representatives of a group. Secondly, the phenomenon of interest is studied in a real-life context, bounded by space and time. Thirdly, the case study research method is based on various sources of information; thus, it is richly descriptive and can describe multiple variables of interest [177]. As the proposed Mapping Methodology incorporates many design methods and tools, and is intended to be used in design practice, validation through case study analysis is considered an appropriate method of inquiry.

Furthermore, qualitative studies, especially workshop-style studies, are a common way to validate DfAM methods and tools for the early phases of the design process. The post-survey, oral feedback and interviews are often used in validation approaches (e.g., [39,46,99,100,178]) but often lack rigidity and details and are conducted on a single case study. The validation of a single case study is not always enough for generalisation through the case study method because a single case study usually includes only one design task. As the design tasks can vary significantly, for example, original design vs redesign, part design vs assembly design, individual task vs team task, or novice vs expert designers, to validate the proposed methodology, several different cases with a broad spectrum of coverage will support better generalisation of conclusions.

The next point of interest is the reliability of the validation method. For case study research to provide a reliable result and construct validity, a well-established protocol for data collection, analysis, interpretations, and composition is essential [172]. This can be achieved by using multiple data sources and simultaneous analysis of those sources, constructing the chain of evidence and review of preliminary results by key informants [179]. The objectivity of the case study emerges from the study of the phenomena without direct impact on the process execution or performance [180].

6.3 Design of Case Study

To conduct case study research first step is to define and design a method for carrying out the case study [168,172]. The objective of the case study design phase is to define a set of procedures to be followed during the case study research, provide a systematic approach, minimise the variations between the cases, ensure the uniformity of collected data and performed analysis, and enable the replication of a study. A well-defined case study method with a rigorous framework and minimal bias is essential for increasing the reliability of the case study research and the validity of the results [181].

The scope of the case study method presented here is defined for conducting the case studies for validation of the developed methodology for mapping product functions with design principles for AM. The case study method defines a theoretical framework of case studies. The theoretical framework defines case study questions, propositions, units of analysis, and criteria for selecting cases.

6.3.1 Case study questions

The basis of the theoretical framework of the case study are questions that need to be answered. Questions are the critical part of the case study design phase, and they should be designed with care [172]. The case study questions are a starting point in qualitative research that shapes the study when stated correctly [182]. In qualitative research, the questions should invite a process of exploration and be formulated in a way that requires a qualitative answer rather than a simple yes or no answer [182]. The developed questions relate to the thesis hypothesis (Section 1.2.2) and investigate the influence of the proposed methodology on the designers and design process. The case study questions are stated as *how* questions, as this type of questions, together with *why* questions, are the most suitable for the case study research method [172]. Furthermore, the questions are formulated following the recommendations for qualitative research questions without presuming the implication of the study [182]. The following three questions are stated:

- **CSQ1:** How does the methodology for mapping product functions and design principles for AM affect the creation of function structures of AM products?
- **CSQ2:** How does the methodology for mapping product functions and design principles for AM affect the use of unique capabilities of AM and the embodiment of AM solutions?
- **CSQ3:** How does the methodology for mapping product functions and design principles for AM affect the function integration?

| 6.3.2 Case study propositions

Propositions in case study research are used as guidance for the researcher throughout the study. Their role is to narrow the scope of the study and keep the research within the study's boundaries [181]. In addition, the well-formed propositions guide researchers to relevant sources of evidence and help researchers gather the information needed to conduct the study. Four propositions are defined before conducting the case study to aid in collecting and analysing data. The proposition corresponds to the case study questions stated in Section 6.3.1.

- **PR1:** The methodology for mapping product functions and design principles for AM enables, through the FC Method, unambiguous expression and repeatable representation of AM product function models.
- **PR2:** The methodology for mapping product functions and design principles for AM enables the utilisation of AM design possibilities by providing a variety of suggestions for fulfilling the functions of a product.
- **PR3:** The methodology for mapping product functions and design principles for AM supports function integration by providing recommendations for fulfilling blocks of functions together.
- **PR4:** The methodology for mapping product functions with design principles for AM enables the embodiment of design solutions adapted for AM.

| 6.3.3 Units of analysis

The unit of analysis defines the case of the study and the design of the research. It also determines which procedure for data collection can be adopted [183]. As the purpose of using the case study method in this research is to validate the methodology for mapping functions, the unit of analysis is the developed methodology for mapping product functions and DP for AM. The scope of the case studies and the unit of analysis is the early phases of the product development process in which the developed methodology is used for functional modelling of the product, search for possible solutions through function mapping and embodiment of the solutions in generated concept.

| 6.3.4 Selection of Cases

The cases used in the case study method must be selected according to the goal and purpose of the case study. Flyvbjerg [173] suggests two sets of strategies for selecting cases: random selection and information-oriented selection. Random selection is used to avoid systematic

biases in the sample but requires a significant sample size for generalisation. On the other hand, information-oriented selection maximises the value of information from a single case or small samples. Here the emphasis is to select cases regarding their information content. In this context, four sub-strategies exist: extreme cases, maximum variation cases, critical cases, and paradigmatic cases [173]. Out of the four strategies, the maximum variation cases strategy is often used for validation purposes, together with multiple-case design, as it enables the study of different cases. Moreover, if the results from different cases are similar, a multiple-case design provides more compelling evidence toward the validation of the research hypothesis [181]. Furthermore, the maximum variation cases strategy enables gathering information regarding the importance of various contexts by varying dimensions of the selected cases [173].

The next question is how many cases are needed in a multiple case study design. Flyvbjerg [173] suggests using 3-4 very different cases, while Eisenhardt [174] states there is no ideal number, but 4-10 cases usually work well. However, if there are fewer than 4 cases, it can be challenging to make a strong generalisation, and with more than 10, the volume of data becomes too large to cope with. Therefore, in a multiple case study research, the cases should be selected in a manner that one or more dimensions vary between the cases. In addition, for multiple-case studies, it is common to use exemplary cases representative of the research goal. For these reasons, used cases should represent endpoints on a broad spectrum of dimensions. In this research, five different dimensions are considered in the selection of cases, and selection is conducted to include the extreme points across the five dimensions (Section 6.4.3). These five dimensions are chosen to represent a variety of scenarios in which the Mapping Methodology can be used and are relevant to the previously stated purpose of the methodology.

The first dimension relates to the type of product being designed using the developed mapping method. Here two types of products are investigated, the product as a single part and the product as an assembly of two or more AM parts. The second dimension represents who conducted the design project, an individual designer or a design team made of two or more designers. The third dimension describes the context of the case studies. Here two types of contexts are recognised, an academic context where the method is applied by student designers and an industry context where the method is applied by professional designers. The final two dimensions measure the prior knowledge about functional modelling and AM of designers included in projects used as the case studies.

6.4 Case Study Preparation

After the case study design phase defined the goal and scope of the study, a preparation phase is conducted. The preparation phase includes a definition of data collection procedures, establishment of strategies and techniques for data analysis with the definition of criteria for interpretation of the results, and decision on cases according to the predefined dimensions. The goal is to provide a straightforward procedure for handling cases to achieve a uniformity of collected data and performed analysis to ease the comparison of the cases, facilitate the process of drawing conclusions, enable independent reviews, and replication of the study [168,172].

6.4.1 Data collection procedure

The data collection procedure is established before conducting the studies because a well-defined procedure guides the collecting process and ensures all relevant data are collected. It also reduces the effort of collecting all available data, as a significant portion might not have value for the investigated phenomena and questions of the case study [172]. Furthermore, the data collection procedure has two main objectives: establishing the database and establishing the method for data analysis. The database of collected data in raw form enables a systematic overview of data when drawing conclusions from the case studies. It enables the independent examination of data by a third party to confirm or dispute the conclusions or draw some new conclusions. Furthermore, establishing the protocol of how the data will be analysed ensures the right data are gathered, no overflow of data is recorded, and provides a systematic way on how the data is analysed, thus increasing the validity of the conducted study.

To increase the rigidity of the study, literature sources recommend the use of multiple sources of evidence and triangulation of collected data to support the claims of the study [168,172,173]. When multiple data sources support the claim, it is more likely the claim is valid. In this case study, the research data is collected in three ways: (i) through project documentation, (ii) by observation of designers and the design process, and (iii) through interviews with designers. The data are collected through 9 stages of case studies, with different modes of data collection in each stage (Figure 6.2).

The first mode of data collection are documents made in a design project that reflect the use of a developed mapping methodology. This data collection and analysis mode is common in case study research [177]. The documents collected include the direct outputs of the mapping method (function structures and mapped structures) but also additional documents, like design requirements, concepts, prototypes, or project reports. While the former documents will exist in all case studies, the latter will differ due to the specificities of each design project included

in the study. The project documents provide objective data because the data is the direct output of the function modelling and mapping activities that exist in all cases, so it can be easily compared.

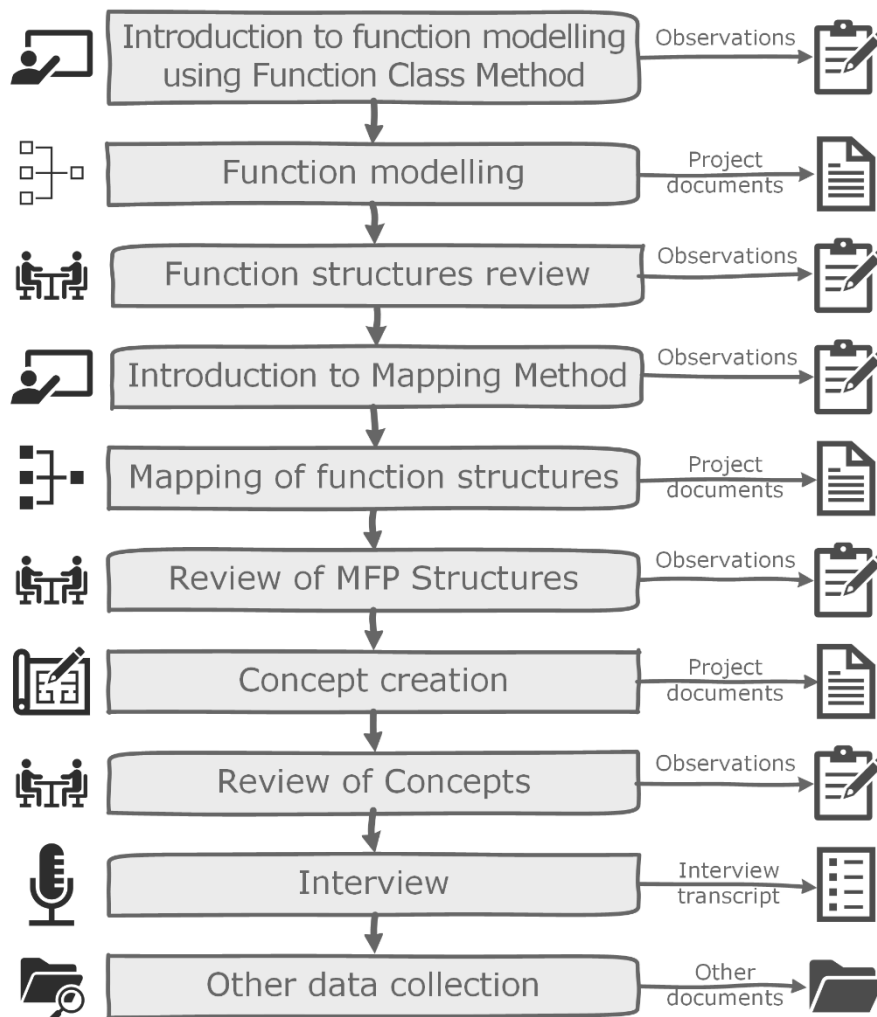

Figure 6.2 Data Collection Protocol

The second mode of data collection is the observation of designers during the learning and application of mapping methodology. The observations by the case study researcher can provide a piece of objective information about the research topic [177]. When conducting an observation, a researcher must clearly define what is being observed and should record all relevant information [177]. This often includes information regarding observation time, date and location, description of specific activities and events, and initial impressions regarding research questions. In doing the observation, the researcher must be aware of their personal role and possible biases in the research [177].

The author is involved in all projects being studied, firstly to explain and teach designers how to use the developed mapping methodology and secondly in the advisory role to provide guidance and answer any questions. The author restrained himself from executing the design

tasks but had an advisory role. Furthermore, the author interacted with the designers during project checkpoints and debriefs. During the lectures, reviews, and project-related communication, the author noted his observations on how the designers understand and apply the mapping methodology and what are the results of the design activities. In recording the observations, particular care was given to the objective recording of observations without including conclusions about observed phenomena in the records.

The third mode of data collection is interview. The purpose of the interview is “*to obtain descriptions of the life world of the interviewee with respect to interpreting the meaning of the described phenomena*” [184]. Interviews are used for gathering qualitative data by asking designers direct questions [176]. They are often found in case study research as a form of data collection because interviews enable gathering rich and personalised information [177].

There exist three types of interviews, structured, semi-structured, and unstructured. For case study research, semi-structured interviews are well suited because they allow the researcher to ask predefined but flexible questions as well as to ask follow-up questions depending on the answers of the interviewee and their interests, allowing broader insight into the case [177].

When conducting an interview, several guidelines should be followed. Firstly, the type of interview must be determined, individual or group interviews. While the individual interview is more time consuming, it provides significant data [177], and as the cases are conducted mostly by a single designer, the individual interviews are used as a form of data collection. Secondly, an interview guide or protocol is developed, and it defines questions the researcher asks the interviewee to gain insights into the research questions [177]. Furthermore, the researcher must be aware of the setting in which the interview takes place to avoid distractions and allow the interviewee to respond freely. Also, the means of recording must be defined prior to the interviews, as well as all legal and ethical requirements must be addressed [177]. The questions that are asked should be open-ended rather than yes/no questions to allow the interviewee to give their own answer and opinion. Also, the researcher must carefully listen during the interview and limit their talking and comments to avoid influencing the interviewee's answers [177]. The questions for the interview are structured following the suggestions from Hancock & Algozzine [177]. The interview guide used in this research is presented in Table 6.1.

Table 6.1 Interview guide

Interviewee	Individual designer
Type of interview	Semi-structured interview
Interview setting	One-on-one interview, conducted in person after the end of the project
Recording of interview	Researcher notes during the interview, audio recording, transcripts of audio recording
Interview structure	<ol style="list-style-type: none"> 1. An interviewee will be informed about the purpose of the interviews, ways of recording and analysis, and their rights. 2. The recording will start for the duration of the interview. 3. Each interviewee will be asked the same set of questions in exact order. Additional sub-questions might be asked if necessary. 4. After the interview, the recording will be transcribed.
Interview questions	<ol style="list-style-type: none"> 1. Did you have any experience with function modelling before this project? If yes, please describe your previous experience with function modelling, what kind of function models did you create, for which products and how many? 2. Did you have any experience with additive manufacturing and design for additive manufacturing before this project? If yes, please describe your previous experience with AM and DfAM. 3. When you think back about the introductory lecture on function modelling using the Function Class approach, what was your impression about the approach? Did you understand the concept of Function Classes and the templates and rules provided during the lecture? 4. What was your experience using the Function Class modelling approach (templates, rules, and application)? Were the vocabulary, FCs, and rules clear and understandable? 5. Please describe your function modelling process from a logical point of view. Please highlight the difficulties you encountered and what you find helpful during function modelling. 6. When you think back about the lecture on methodology for mapping product functions with design principles for AM, what was your impression about the approach? Did you understand the concept of mapping methodology and the design principles and rules provided during the lecture? 7. What was your experience using tools for mapping product functions (rules and application)? Were the mapping rules clear and understandable? 8. Were the design principles provided for the mapping process understandable? Were you able to comprehend the meaning of design principles and the meaning of AM possibilities they were referring to? 9. Please describe your mapping process from a logical point of view. Please highlight the difficulties you encountered and what you find helpful during the mapping process. 10. Please describe your process of generating concepts using mapped function structures. Could you describe how the mapping process influenced your approach to generating concepts? Please highlight the difficulties you encountered and what you find helpful during the concept generation process.

	<p>11. What is your opinion about solutions the mapping process suggested to you? Did you find the quality and broadness of suggested solutions adequate?</p> <p>12. Do you think the mapping process enabled you to achieve function integration (solving two or more functions with the same technical solution)? Please provide an example if possible.</p> <p>13. What is your opinion on using Function Modelling App? Was it a helpful tool for applying mapping methodology? Please highlight the difficulties you encountered and what you find helpful in using the Function Modelling App.</p> <p>14. Do you have any additional comments or thoughts about the entire process of function modelling, mapping, and concept generation?</p>
--	--

After collecting all three types of data, the data is organised and stored. To ease the management and analysis of collected data but also to enable future independent review, the data are recorded and organised in the same format. This aids in the systematic collection and review of data and eases the comparison of multiple cases. Furthermore, the referencing system is established for easier analysis of data. The data is referenced with a unique ID for each piece of data in CS-DM-# format, where CS stands for the case study ID, DM for the mode of data collection (PD – Project Document, ON – Observation Notes, IN – Interview), and # for data ordinal number. Data for each case study is systemised using the tabular format template (Table 6.2).

Table 6.2 Data systemisation template

Data ID	Description of data	Data reference
CS-DM-#1	Data description 1	Reference 1
CS-DM-#2	Data description 2	Reference 2

6.4.2 Logic linking data to propositions

After the protocol for collecting data is established next step is the data analysis. Data analysis is used for examination, testing, verification, interpretation, and categorisation of both qualitative and quantitative data collected in a case study [181]. The case study method prescribes four general strategies for data analysis [172]:

- *Relying on theoretical propositions,*
- *Working your data from the “ground up”,*
- *Developing a case description,*
- *Examining plausible rival explanations.*

6. Case Study Design

The strategies are not mutually exclusive and can be used together in any combination. Whatever the analytic strategy is adopted, the importance is on linking the data to the concepts of interest to analyse the data [172]. The strategy adopted in this research project is based on the first, third and fourth strategies. Firstly, the propositions are established to guide the case study research (Section 6.3.2). Secondly, the data collection procedure (Section 6.4.1) provides a framework for a common description of cases and supports their comparison. Furthermore, the data gathered is compared to rival explanations to increase the validity of drawn conclusions.

Regardless of the general strategy chosen, an analytic technique must be adopted to develop the internal and external validity of case studies [172]. The five commonly used analytic techniques are [172]:

1. Pattern matching,
2. Explanation building,
3. Time-series analysis,
4. Logic model,
5. Cross-case synthesis.

Pattern matching and cross-case synthesis are adopted for conducting case studies in this research project. The pattern matching technique is one of the most suitable techniques in qualitative research as it compares the predicted patterns with empirically based patterns [172], emphasising the replication logic of the case study. In a descriptive study as the one used in this thesis, the pattern matching technique aid in the evaluation of the case study propositions and provide empirical evidence for supporting or disapproving the stated claims in the research. For each case study proposition, a pattern is established prior to data analysis, but to avoid stacking data to a single pattern narrative and increase the objectivity of the analysis, rival patterns are established as well [181]. When the patterns are established, data can be matched with a pattern it supports. The pattern with the most empirical evidence provides the most significant support or opposition for the individual case study proposition. Data that do not support any pattern can be ignored during data analysis. Pattern matching is conducted for each individual case study. The patterns for each proposition (Section 6.3.2) are formed with high contrast between the pattern and rival pattern to ease the binary matching of data (Table 6.3). Furthermore, clear criteria for interpreting case study results for matching data are defined to facilitate the matching process. The definition of matching criteria aids in the objectivity of analysis and helps in an independent review of conducted analysis and drawn conclusions.

The second analytic technique used in this research is cross-case synthesis. The cross-case synthesis compares pattern matchings and draws conclusions from each individual case to draw a generalised conclusion from the analysed data [172]. When multiple case studies support the same claim, the claim has more validity. On the other hand, if results from case studies are contradictive, it will indicate the claim is not investigated enough. By analysing those data, propositions or recommendations for future development can be drawn.

Table 6.3 Case Study Patterns

	Pattern	Rival Pattern
PR1	Designer(s) can create function structure using FC method and through it clearly express the functionality of AM product(s).	Designer(s) are not able to express the functionality of AM products using FC method for creation of function structures.
	Criteria: Designer(s) shows the good understanding of the FC method. The created function structures clearly express the product functionality and are in accordance with FCs and modelling rules.	Criteria: Designer(s) have issues with understanding of the FC method. The created function structures do not express the functionality of the product clearly or are not represented according to the FCs and modelling rules.
PR2	Designer(s) utilised a variety of AM designs solutions using mapping methodology.	Despite using the mapping methodology, designer(s) utilised a small number of different AM solutions.
	Criteria: MFP Structures show a great diversity of chosen AM principles as solutions for individual functions or blocks of functions.	Criteria: MFP Structures show similar AM principles used as a solution for individual functions or blocks of functions. The difference being in only one or two different DPs.
PR3	Designer(s) used suggested mapping to integrate multiple functions using one design solution.	Designer(s) did not embrace the function integration and looked for individual solutions for each function.
	Criteria: Mapped function structures or concepts show designers preferred the use of solutions for integrated functions.	Criteria: Mapped function structures or concepts show designers preferred the use of mapping rules for individual functions.
PR4	Designer(s) created concepts that embody design solutions only or predominantly feasible using AM.	Designer(s) created concepts that are feasible with other technologies besides AM.
	Criteria: Conceptual solutions and features are only feasible if manufactured using AM.	Criteria: Conceptual solutions and features are manufacturable using conventional manufacturing technologies.

6.4.3 Selected Case Studies

After the case study protocol is designed, the case studies are selected according to the protocol and argumentation in Section 6.3.4. The cases are selected using two criteria: (i) the cases must differ on five dimensions with the goal of reaching extreme points in each dimension

6. Case Study Design

across the cases, and (ii) the project used as cases fit in the time frame of the research project and designers are willing to participate in the research. Four cases are studied for the validation of the Mapping Methodology. Table 6.4 lists the four cases with their ID and their values on five dimensions established in the design of case study. Figure 6.3 shows the coverage of individual cases and overall coverage across the dimensions. With the selected cases, the maximum points across the dimensions are achieved, except for the AM experience, as none of the designers had extensive AM experience before the respective projects were conducted.

Table 6.4 Cases used for Mapping Methodology validation

Case Study Project	ID	Product	Type of Product	Who designs	Context	AM Exp.	FM Exp.
Application of 3D scanning and DMLS manufacturing process in reversable engineering	GE	Gear	Part	Individual	Academic	Basic	No
Development of bicycle using design principles for additive manufacturing	BI	Bicycle	Assembly	Individual	Academic	Basic	Yes
Development of toy car powered by air balloon	TC	Toy Car	Assembly	Team	Academic	No	No
Evaluation of AM for the use in processing industry	HE	Heat Exchanger	Part	Individual	Industry	No	Yes

To achieve the uniformity of representation and comparison of studies, all four studies are described and analysed using the same case study report format (Figure 6.4). Each report starts with a description of the case study context. Here the overview of the project is given, followed by a description of the designer's background information. Then the rationale for the application of the Mapping Methodology in the project is given. The case study context concludes with a graphical overview of the case and list of the data gathered. The graphical overview summarises the above-mentioned project and designer information. It also shows quantitative data about the use of the mapping methodology (number of created function structures, MFP structures, concepts and prototypes, and number of used FCs, MRs and DPs) and examples of Mapping Methodology outputs. Individual case study reports and a cross-case analysis are presented in Chapter 7. The raw data referenced in the reports are enclosed in Appendix E, Appendix F, Appendix G, and Appendix H

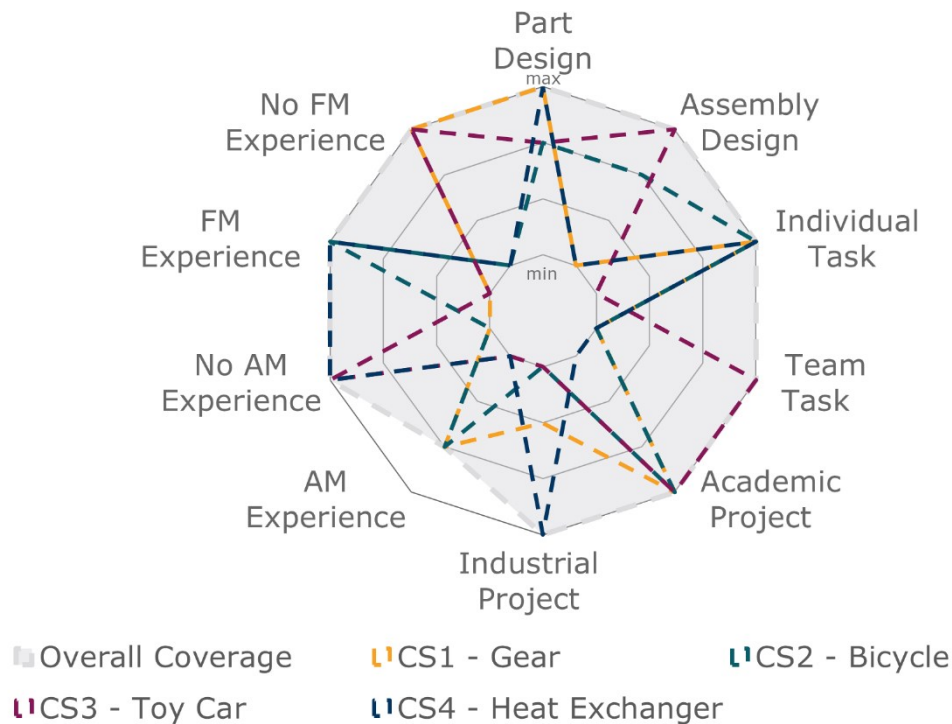

Figure 6.3 Overview of selected cases

Case Study Report

1. Case study context

- Project description
- Designer's background
- Reasoning why Mapping Methodology was used
- Mapping Methodology application context
- Graphical overview of the case
- Case Study Data Sources

2. Case study report & analysis

- Introduction to FC Method
- Creation of function structures
- Introduction to Mapping Method (MRs and DPs)
- Applying Mapping Method
- Creation of concepts and influence of Mapping Methodology on concept generation
- (Concept selection and embodiment)

4. Conclusion & Pattern Matching

- Pattern Matching table
- Remarks
- Insight gained

Appendix

- Project documents
- Observation Notes
- Interview

Figure 6.4 Case Study Report Format.

This page intentionally left blank.

Chapter 7 is the second part of Descriptive Study II. The results of the four conducted case studies are presented and discussed in this chapter. Each case study is individually presented through the description of the case context, case study report and analysis of the case using the pattern matching technique. Finally, the cases are compared in a cross-case study analysis to generalise the results.

| 7.1 Case Study 1: AM Gear

| 7.1.1 Case study context

The context of the first case study is the application of the methodology for mapping product functions and DPs for AM to redesign a gear for AM. The case is a part of the bachelor theses project, “Application of 3D scanning and DMLS manufacturing process in reversible engineering” [185], in which the mapping methodology was used. The project took place from September 2021 to February 2022 at the University of Zagreb, Faculty of Mechanical Engineering and Naval Architecture, in collaboration with an industrial partner from north of Croatia who provided equipment for 3D scanning and manufacturing of the final design using Direct Metal Laser Sintering (DMLS) process.

As 3D scanning and AM technologies are becoming more and more popular, they are often used for reverse engineering and manufacturing of a product based on the existing physical product, often as a replacement part, when the original spare parts or design drawings are not available. The goal of the bachelor thesis project was to establish a methodology for reverse engineering based on the 3D scanning and DMLS process to enable the utilisation of DMLS potentials and, through it, provide an additional value to a product being replicated. The project consisted of several steps and phases. Firstly, the literature review was conducted, and the initial protocol for reverse engineering was established. This was followed by 3D scanning of a case study product (gear), its redesign for AM and manufacturing using DMLS. Finally, a new AM gear was 3D scanned and geometrically compared with the original. Finally, the protocol for reverse engineering was reviewed and consolidated based on the case study observations.

The project was conducted by a bachelor’s student in the seventh semester of undergraduate studies. She is a fourth-year student in a Mechanical Engineering course, specialisation in Engineering Modelling and Computer Simulation. During her studies, she did not have any

7. Case Study Results

courses about design methods, function modelling or generation of concepts. Therefore, the project and the use of the mapping method is her first encounter with systematic design methods. Her knowledge about AM prior to the project is from the industrial internship. Before conducting the bachelor thesis project, she gained first-hand experience using DMLS and FDM processes through a one-month internship with an industrial partner on this project. Her experience included preparing CAD files and AM machines, monitoring AM build process and handling post-processing operations, but it did not include a design for AM (GE-IN-01).

Because the project included the need for a redesign of gear to achieve additional functionalities and leverage the use of DMLS in manufacturing a replacement part, it was decided to apply the mapping methodology in phase three of the project (GE-ON-01) to redesign the gear for AM. When the redesigning phase was conducted, the mapping methodology was in the final stages of its development, and the designer did not have the final version of mapping rules, principles, and a computational tool at her disposal. However, the designer used the computational tool after conducting the project. Because she was familiar with the mapping methodology, she could provide valuable feedback on the use of the computational tool as she was introduced to the methodology and computational tool separately. The designer applied the method according to the given instructions. The observations from the conducted case study were used for feedback information to finalise the mapping methodology.

The mapping methodology was performed by a single designer. She applied the mapping methodology for the redesign of a single part. A graphical overview of the case study is shown in Figure 7.1, while Table 7.1 lists all data sources gathered in this case study enclosed in Appendix E.

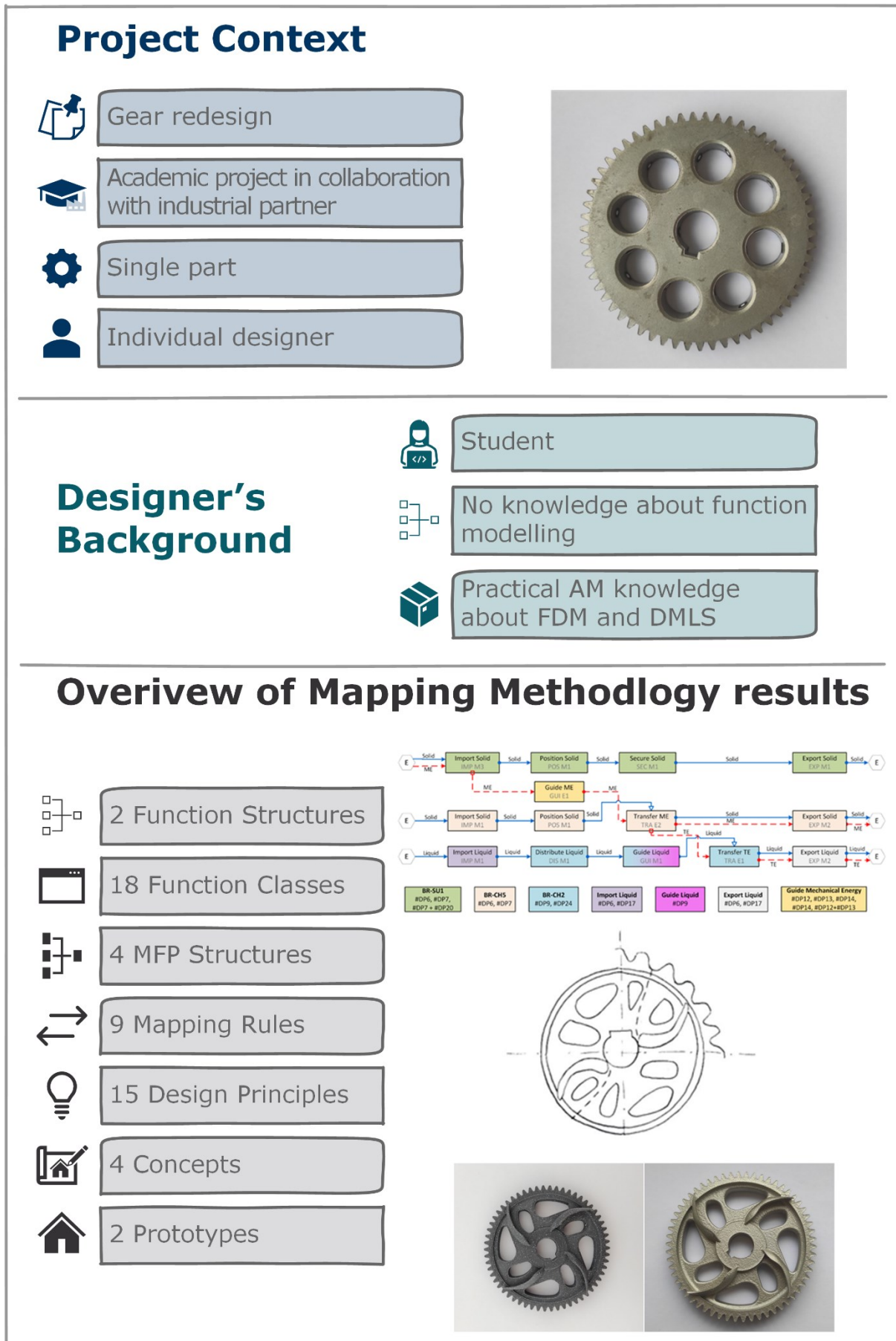

Figure 7.1 Overview of Case Study 1: AM Gear [186]

Table 7.1 List of data sources for Case Study 1, AM Gear

Data ID	Description of data	Data reference
GE-PD-01	Function structure of the gear (1st iteration)	E.1.1
GE-PD-02	Function structure of the gear with cooling (1st iteration)	E.1.2
GE-PD-03	Function structure of the gear with liquid cooling	E.1.3
GE-PD-04	Function structure of the gear with gas cooling	E.1.4
GE-PD-05	Fully mapped function structure – liquid cooling	E.1.5
GE-PD-06	Fully mapped function structure – gas cooling	E.1.6
GE-PD-07	MFP Structure 1	E.1.7
GE-PD-08	MFP Structure 2	E.1.8
GE-PD-09	MFP Structure 3	E.1.9
GE-PD-10	Concept 1	E.1.10
GE-PD-11	Concept 2	E.1.11
GE-PD-12	Concept 3	E.1.12
GE-PD-13	Concept 4	E.1.13
GE-PD-14	CAD Model	E.1.14
GE-PD-15	AM Gear (Physical Models)	E.1.15
GE-ON-01	Project setup observations	E.2.1
GE-ON-02	Observations of FC learning process	E.2.2
GE-ON-03	Observations during function structure review 1	E.2.3
GE-ON-04	Observations during function structure review 2	E.2.4
GE-ON-05	Observations during mapping lesson	E.2.5
GE-ON-06	Observations during concept reviews	E.2.6
GE-ON-07	Observations during product development	E.2.7
GE-IN-01	Interview - Background information	E.3.1
GE-IN-02	Interview - FC Method	E.3.2
GE-IN-03	Interview - Mapping Method	E.3.3
GE-IN-04	Interview - Other information	E.3.4

7.1.2 Case study report & analysis

In the first case study, the mapping methodology was used to redesign existing gear to optimise the geometry for the DMLS process and incorporate additional functionalities enabled with AM into a gear. Before the project, the designer had never used any function modelling technique, and this was her first encounter with function modelling. A comprehensive introduction lecture on functions, function modelling, function structures and the FC method was given (GE-ON-02). Therefore, the designer's only knowledge about creating function structures is through the use of the FC method. During the lecture, the designer understood the concept of product functions and how to use FCs to create function structures. Furthermore, the

designer could comprehend the meaning of all five function structures that were used as examples (GE-ON-02). Learning how to use FCs for a novice designer in functional modelling was easy, and no issues were encountered (GE-ON-02). According to the designer, the FCs are understandable and logical (GE-IN-02).

The function modelling using FCs was done in two iterations, and it was done without a computational tool for modelling. The designer had only paper and PDF copies of FCs, primary and modelling rules at her disposal. In the first iteration, the designer created two function structures, a structure of the gear and part of a function structure regarding additional cooling functionality (GE-PD-01 & GE-PD-02). The function structures were reviewed, but they were not fully compliant with FCs. In the first function structure designer had minor syntax errors, but the overall functionality of the gear was clear, and the designer had no trouble expressing and explaining its functionality. On the other hand, the function structure of the gear with cooling represented only functions associated with the cooling capability of the gear, neglecting all the other gear functionalities. As a standalone entity, this function structure was not clear, but if reviewed together with the function structure of the gear, the functionality could be comprehended. The errors in the first iteration can be attributed to two main factors: (i) the designer used the FCs for the first time, and (ii) there was no computational tool to limit the designer in applying the function block that is not prescribed. However, this is not a concern because it is expected that for novice designer some time is needed to learn a new design method. Also, the design process is iterative in nature, and one of the roles of function structure is to achieve a common understanding of product functionality through revisions and iterations, which was achieved already in the second iteration. Furthermore, the function structure of the gear had only syntax errors, showing the designer was able to express the gear functionality in the first attempt using the FC method.

After the review, four mistakes in total were noted and communicated to the designer (GE-ON-03). Based on the given comments' the designer reworked the function structures and created two function structures of the gear with one using the flow of liquid (GE-PD-03) and the second with a flow of gas (GE-PD-04) for achieving the function of cooling the gear, with 14 function blocks in former and 13 in the later function structure. No mistakes were found during the second review, and both function structures were fully compliant with FCs and modelling rules (GE-ON-04). The designer stated the FCs were easy to use, and she could describe the functionality of the product as she saw fit without any limitations regarding expressiveness. The function structures were clear, and the intended functionality was

understandable during the review. In addition, the designer and reviewer had a common understanding of AM gear functionality (GE-ON-04).

In this case study, the thesis author conducted the initial mapping and imitated the computational tool that should perform and show all possible mappings, as it was envisioned the mapping process would look at the time rather than the selective approach adopted later in the research project. Therefore, the designer was given two mapped function structures where all applicable mapping rules and principles were noted (GE-PD-05 & GE-PD-06). Both function structures were fully mapped, without unmapped function and a few blocks offering multiple mapping combinations. The mapping suggested both individual and block mappings, where the latter were essential for achieving function integration during concept development (GE-PD-05, GE-PD-06). Function structure containing the flow of liquid as a coolant is mapped with 7 mapping rules, of which 2 mapping rules are applicable on the same function block in multiple combinations. In total, 10 different DPs are mapped onto this function structure. There are 8 possible MRs for the second structure, with 4 rules applicable in multiple combinations and 11 different DPs associated with those MRs. The mapping logic was explained to the designer, and she was given a list of all MRs and DPs so she could review the mappings during concept generation. The instructions for the designer were to choose the MRs and associated DPs and combine them in a few MFP Structures to create a variety of concepts (GE-ON-05).

The designer successfully used the fully mapped function structures to create three MFP Structures (GE-PD-07, GE-PD-08, GE-PD-09), from which four concepts were generated. The designer showed an understanding of the MRs, DPs, and the role of MFP Structures in the concept generation process. For the gas cooling structure, only one MFP Structure was created. According to the designer, she only came up with one combination of DPs that satisfied all the requirements and created a concept. For the liquid cooling, two MFP structures were created, with differences in both MFPs and DPs applied, showing how the variety of combinations can be used to explore the AM design space.

From three MFP Structures designer created four concepts of AM gear. Three concepts were with liquid cooling (GE-PD-11, GE-PD-12, and GE-PD-13), and one with gas cooling (GE-PD-10). The four concepts utilised 7 different AM DPs. Due to project constraints, the created concepts kept the part of the geometry as it is (gear teeth, shaft hub); thus, AM redesign was applied only on the part of gear and was used for solving only some of its functions. However, in function structure, the gear teeth and shaft hub functionality were described, and one possible solution mapping method provided was integrating standard geometry in an AM product which was used due to the prescribed design requirements. On the other hand, for other functions

number of different AM DPs were suggested by the mapping. The designer primarily focused on DPs regarding the void and lattice structures; thus, only part of the suggested AM design space was explored. And while the number of profoundly different solutions is not high, the ones used have complex geometry and embrace the AM potentials and are adapted for AM. Furthermore, the chosen solutions do integrate multiple functions in a single feature. For example, void structures with internal channels (Concepts 3 & 4) and open lattice structures (Concepts 1 & 2) combine multiple functions, regarding the guide of mechanical energy and cooling capability, in single features, thus achieving function integration.

The designer created Pugh's matrix for concept selection and chose concept four for further development based on the established selection criteria. Concept four was based on the void structure for guiding mechanical energy from the shaft hub to the gear teeth, with internal channels for cooling. The concept was further developed in embodiment and detail design through multiple iterations and prototypes. The final design of redesigned AM gear included all the features proposed in the concept and incorporated additional details like the distribution of coolant using multiple internal channels. The manufacturing of the prototypes using two different AM processes showed the embodiment of AM DPs in physical objects (GE-PD-14, GE-PD-15).

| 7.1.3 Conclusion & Pattern Matching

The pattern matching technique is carried out to conclude the case study report. Table 7.2 shows the original and rival patterns established in Section 6.4.2 matched with associated supporting evidence (SE). The dominant patterns with the most supporting evidence are highlighted.

For the first proposition, most of the evidence supports the original pattern. While there were some issues in the first iteration of function structures, they could be attributed to the novelty of the approach and the necessary learning curve in adopting the FC method. In the case of novice designers, evidence supports the claim that the FC method is a suitable tool for expressing and representing AM products function models.

In the second proposition, the original pattern has more supporting evidence. Because of the redesign and design requirements, part of the geometry could not be altered, thus reducing the design space available for implementing various AM solutions. For the case of gas cooling, only one MFP Structure and concept were created, while for liquid cooling, two MFP Structures and three concepts were made. Nevertheless, innovative and AM-specific solutions can be seen in created concepts.

Table 7.2 Pattern Matching for Case Study 1

	Pattern	Rival Pattern
PR1	Designer(s) can create function structure using FC method and through it clearly express the functionality of AM product(s).	Designer(s) are not able to express the functionality of AM products using FC method for creation of function structures.
SE	GE-PD-01, GE-PD-03, GE-PD-04, GE-ON-02, GE-ON-03, GE-ON-04, GE-IN-02	GE-PD-02, GE-ON-03
PR2	Designer(s) utilised a variety of AM designs solutions using mapping methodology.	Despite using the mapping methodology, designer(s) utilised a small number of different AM solutions.
SE	GE-PD-08, GE-PD-09, GE-PD-11, GE-PD-12, GE-PD-13	GE-PD-07, GE-PD-10, GE-IN-04
PR3	Designer(s) used suggested mapping to integrate multiple functions using one design solution.	Designer(s) did not embrace the function integration and looked for individual solutions for each function.
SE	GE-PD-07, GE-PD-08, GE-PD-09, GE-PD-10, GE-PD-11, GE-PD-12, GE-PD-13, GE-ON-07, GE-IN-03	
PR4	Designer(s) created concepts that embody design solutions only or predominantly feasible using AM.	Designer(s) created concepts that are feasible with other technologies besides AM.
SE	GE-PD-10, GE-PD-11, GE-PD-12, GE-PD-13, GE-PD-14, GE-PD-15, GE-ON-07	

Furthermore, the function integration was achieved in the created concepts by combining functionality regarding guiding mechanical energy and cooling of a gear. The cooling capability was not present in gear before the redesign. Still, the application of mapping methodology enabled the identification of additional functionality and its embodiment by integrating it with other gear functions in a comprehensive design feature. While a simple example, it nevertheless provides supporting evidence for the third proposition that mapping methodology supports the integration of functions.

Multiple evidence sources support the fourth proposition. The concepts created are impossible to manufacture using other technologies besides AM as they incorporate lattice structures and internal channels. The successful manufacturing of the developed concept using two different AM processes shows the mapping methodology enables the embodiment of DPs.

The first case study showed a successful application of mapping methodology by the inexperienced designer in the context of redesigning an existing component. The insights gained from the first case study are summarised in the following points:

- FC method is an adequate design method for function modelling of parts,
- The designer could easily express product functions and overall product functionality using the FCs,
- The mapping method enabled the creation of multiple concepts that utilise AM capabilities,
- The mapping method enabled the integration of functions and the creation of innovative solutions.

It can be concluded that the conducted case study provided evidence for supporting the research hypothesis and indicated the suitability of mapping methodology to redesign a mechanical part by a novice designer.

| 7.2 Case Study 2: AM Bicycle

| 7.2.1 Case study context

The context of the second case study is applying the methodology for mapping product functions and design principles for AM in the context of designing a new AM Bicycle. The case is a part of a bachelor thesis project called “Development of bicycle using design principles for additive manufacturing” [187]. The project took place from September 2021 to February 2022 at the University of Zagreb, Faculty of Mechanical Engineering and Naval Architecture.

As AM is becoming common and affordable manufacturing technology, more and more designers experiment with AM to redesign a variety of different products. With the development of large-scale AM machines, one of the most widespread products, a bicycle, is also being redesigned for AM. Many prototypes of AM bicycles appeared in the last few years that show the use of AM to increase their performance, provide a new aesthetic value or enable customisation for individual users. The goal of the bachelor thesis project was to design and develop a bicycle that will be manufactured with AM and will utilise the unique possibilities of AM to provide new values to the bicycle and its user. The project was focused on the early design phases of the design process and did not include the detailed design of the final product. The project included analysis of existing AM bicycles, the definition of customer needs and design requirements, development of concepts, prototyping to evaluate the best AM solutions, and initial embodiment of the final design.

7. Case Study Results

The project was conducted by a bachelor's student in the seventh semester of undergraduate studies. She is a fourth-year student in a Mechanical Engineering course, specialisation in Product Design and Development. During her studies, she took courses on design methods and product development; thus, she was familiar with systematic design processes and methods. This includes her familiarity with functional modelling, albeit without the use of predefined vocabulary and strict modelling rules. During her studies, student design projects and assignments, she created a few function structures, mostly of small electromechanical devices, such as household appliances and power tools. Before the project, she had some knowledge about AM and DfAM as she had lecture on DfAM and participated in the tutorial on use of AM design heuristics (BI-IN-01).

As the project was about the design of an AM product, it was decided to use the mapping methodology to create function structures of the bicycles, perform the mapping and generate concepts of different bicycle components (BI-ON-01). Therefore, the project's conceptual design phase was entirely based on the mapping methodology. However, when the project started and the conceptual design phase was conducted, the mapping methodology was in the final stages of its development, and the designer did not have the final version of MRs, DPs, and a computational tool at her disposal. The designer applied the method according to the given instructions. After the project was finished, the designer used the computational tool to repeat the function modelling and mapping process. As she was familiar with the mapping methodology, she could provide valuable feedback on the use of the computational tool because she was introduced to methodology and computational tool separately. The observations from the conducted case study were used as feedback information to finalise the mapping methodology. A graphical overview of the case study is shown in Figure 7.2, while Table 7.3 lists all data sources gathered in this case study enclosed in Appendix F.



Figure 7.2 Overview of Case Study 2: AM Bicycle [188]

Table 7.3 List of data sources for Case Study 2: AM Bicycle

Data ID	Description of data	Data reference
BI-PD-01	Function structure of the bicycle	F.1.1
BI-PD-02	Function structure of the wheel	F.1.2
BI-PD-03	Function structure of the pedal	F.1.3
BI-PD-04	Function structure of the bicycle frame	F.1.4
BI-PD-05	Function structure of the hand brake lever	F.1.5
BI-PD-06	Function structure of the seat	F.1.6
BI-PD-07	Function structure of the steering wheel	F.1.7
BI-PD-08	Mapped function structure of the bicycle frame	F.1.8
BI-PD-09	Mapped function structure of the wheel	F.1.9
BI-PD-10	Mapped function structure of the seat	F.1.10
BI-PD-11	Bicycle frame concept 1	F.1.11
BI-PD-12	Bicycle frame concept 2	F.1.12
BI-PD-13	Bicycle frame concept 3	F.1.13
BI-PD-14	Wheel concept 1	F.1.14
BI-PD-15	Wheel concept 2	F.1.15
BI-PD-16	Wheel concept 3	F.1.16
BI-PD-17	Seat concept 1	F.1.17
BI-PD-18	Seat concept 2	F.1.18
BI-PD-19	Prototypes	F.1.19
BI-ON-01	Project setup observations	F.2.1
BI-ON-02	Observations of FC learning process	F.2.2
BI-ON-03	Observations during first function structure review	F.2.3
BI-ON-04	Observations during second function structure review	F.2.4
BI-ON-05	Observations during mapping lesson	F.2.5
BI-ON-06	Observations during concept reviews	F.2.6
BI-ON-07	Observations during prototyping and product development	F.2.7
BI-ON-08	Observations during FM App testing	F.2.8
BI-IN-01	Interview - Background information	F.3.1
BI-IN-02	Interview - FC Method	F.3.2
BI-IN-03	Interview - Mapping Method	F.3.3
BI-IN-04	Interview - Other information	F.3.4

7.2.2 Case study report & analysis

In the second case study, the mapping methodology was used for designing a new AM bicycle. Before the project, the designer was familiar with function modelling and function structures but had never used predefined vocabulary and strict modelling rules. Therefore, a short introduction lecture on the FCs approach was given. During the lecture, the designer had no issues understanding the concept of FCs and could comprehend the meaning of all five

function structures used as examples (BI-ON-02). However, the designer reported that a bit of time was needed to switch on the use of predefined vocabulary and find an appropriate equivalent for the envisioned function (BI-IN-02).

The function modelling using FCs was done in three iterations, and it was done without a computational tool for modelling. The designer had only paper and PDF copies of FCs, primary and modelling rules at her disposal. The designer created seven function structures in the first iteration, one for the entire bicycle and six for individual bicycle components (BI-PD-[01-07]). It is important to emphasize the approach designer used to create function structures. She started the function modelling process by defining functions using natural language terms (in Croatian) by following the logic and rules she learned during her product development courses. After creating these initial function structures, she “translated” them into the language of FCs (BI-ON-03, BI-IN-03). During the first review, it was noted that the designer understood the FCs approach but had some issues in expressing the functionality of the bicycle or its components. The use of the FC Method is applied in two different contexts, for modelling the bicycle as an entire system and for modelling individual components of the bicycle.

In the case of using the FC method for modelling bicycle as a single system, the biggest problem for a designer was to express the functionality of the bicycle. The main reason for this was the number of functions and the complexity of the relations between the functions. In addition, the function structure contained multiple similar function blocks, and the role of each function chain was not clear as the designer's reasoning was focused on the individual components of the bicycle. In the second iteration, some functions were removed, and the designer added an additional description to the function chain. Still, the function structure was not clear, and the functionality of the bicycle was not expressed adequately. This is probably because the designer was thinking about the bicycle in terms of its components and not as a single system; thus, she wanted to model their interactions in the function structure.

When the designer created seven function structures of individual components, she did not encounter any significant issues and could express the product's functionality. The problems that occurred were the application of wrong FC and syntax errors. These issues were discussed during the first review session, and the designer was instructed to redo the function structures (BI-ON-03). In the second iteration, most of the errors in individual function structures were corrected. The function structure of the bicycle frame had a major upgrade as additional functionalities were added (BI-PD-08) to describe added design requirements (visual identity, gear attachment). After the second iteration, due to the project agenda, only the bicycle framework, seat and wheel were further developed.

7. Case Study Results

In the creation of function structures designer did not follow the prescribed protocol of the FC method. The designer first created a function structure using the function modelling approach before and then “translated” it to be compliant with FCs. She also didn’t strictly follow the prescribed representation as she used her own markings of the flows (BI-IN-01, BI-ON-02, BI-ON-03). These representation errors are a consequence of using the pen & paper approach and are not a limitation of the FC method. No such errors occurred when the designer tested the FM App at the end of the project to recreate the function structures.

The mapping procedure in this case study did not follow the final prescribed mapping method. At the time, an earlier iteration of the method was used in which all possible mappings were shown to the designer, rather than the selective approach adopted later during the development of the mapping method. Therefore, the designer was given three mapped function structures where all applicable mapping rules and principles were noted (BI-PD-[08-10]). The two function structures were not fully mapped, and only one offered multiple mapping combinations. The function structure of the bicycle frame (BI-PD-08) was mapped with 6 MRs and 12 DPs, the function structure of the wheel with 3 MRs and 6 DPs, and the function structure of the seat with 3 MRs and 9 DPs. The function structures of three components were mapped using 5 block rule mappings and 7 individual function mappings, thus providing a basis to achieve function integration (BI-PD-[08-10]).

The mapping logic was explained to the designer, and she was given a list of all MRs and DPs so she could review the mappings during concept generation. The instructions for the designer were to choose the rules and associated DPs and combine them in a few MFP Structures and from them create a variety of concepts (BI-ON-05). Although the designer did not apply the MRs herself, she showed an understanding of the mapping method and had no issues in combining the suggested MRs and DPs to create MFP Structures. The designer created 5 MFP Structures in total, that were used for concept generation.

The designer created three different MFP Structures for the bicycle frame, and from each, a concept was generated (BI-PD-[11-13]). The first concept utilises the most MRs and DPs and uses function integration for solving multiple functions with the same design solution. On the other hand, the other two concepts are focused only on solving the function chain on the flow of ME. They utilise the same MRs and differ only in the DPs used for function *Guide ME*.

In the development of the wheel, the designer created one MFP Structure and, from it, created three concepts (BI-PD-[14-16]). All concepts were created as airless tires, hence embodying the same DPs in multiple variations. For the seat, the designer created two MFP Structures and generated two concepts of the seat (BI-PD-17, BI-PD-18).

The created concepts show a diversity of applied AM solutions. For the bicycle frame, three concepts are created (BI-PD-[11-13]). The first one shows a great level of innovativeness, function integration and part consolidation. Using the Mapping Methodology designer created a lightweight frame in which geometrical information (letters) are part of the frame and made in different colours (multicolour AM). The other two frames were focused on lightweight structure and did not solve all the functions. The concepts of the wheel are all based on the same MFP Structure, thus showing the broadness of developed DPs, as the same functions and suggested DPs are embodied in three different variants. The concepts of the seat are based on two different MFP Structures and are focused on lightweight design and user ergonomics.

All created concepts were prototyped in scaled versions or segments. The prototypes were used for the concept evaluation. Concept 1 of the bicycle, concept 2 of the wheel and concept 2 of the seat were selected for further development, and the final design of the AM bicycle was developed and prototyped in a scaled version (BI-PD-19, BI-ON-07).

7.2.3 Conclusion & Pattern Matching

The pattern matching technique is carried out to conclude the case study report. Table 7.4 shows the original and rival patterns established in Section 6.4.2 matched with associated supporting evidence (SE). The dominant patterns with the most supporting evidence are highlighted.

The evidence for the first proposition mostly supports the original patterns showing the suitability of the FC method for function modelling of AM products. However, the evidence also strongly emphasised the shortage of the FC method for function modelling of assemblies. For the case when the designer is already familiar with the function modelling, evidence supports the claim that the FC method is a suitable tool for expressing and representing AM parts function models.

For the second proposition, most evidence show designer has used multiple AM solutions in different products. All concepts of the wheel are embodied differently, although they are based on the same set of DPs, showing the broadness of DPs. Furthermore, while concepts 2 and 3 of the bicycle frame are fairly similar, concept 1 shows the wide variety of AM based solutions incorporated into a single concept.

The function integration addressed in the third proposition was achieved, to some extent, in almost all concepts. The most notable are concept 1 of the frame and concepts of the wheel, where functions for transferring ME and absorption of vibrations are integrated into a single part.

Table 7.4 Pattern Matching for Case Study 2

	Pattern	Rival Pattern
PR1	Designer(s) can create function structure using FC method and through it clearly express the functionality of AM product(s).	Designer(s) are not able to express the functionality of AM products using FC method for creation of function structures.
SE	BI-PD-02, BI-PD-03, BI-PD-04, BI-PD-05, BI-PD-06, BI-PD-07	BI-PD-01
PR2	Designer(s) utilised a variety of AM designs solutions using mapping methodology.	Despite using the mapping methodology, designer(s) utilised a small number of different AM solutions.
SE	BI-PD-11, BI-PD-14, BI-PD-15, BI-PD-16, BI-PD-17, BI-PD-18	BI-PD-12, BI-PD-13
PR3	Designer(s) used suggested mapping to integrate multiple functions using one design solution.	Designer(s) did not embrace the function integration and looked for individual solutions for each function.
SE	BI-PD-11, BI-PD-14, BI-PD-15, BI-PD-16, BI-PD-17	BI-PD-12, BI-PD-13
PR4	Designer(s) created concepts that embody design solutions only or predominantly feasible using AM.	Designer(s) created concepts that are feasible with other technologies besides AM.
SE	BI-PD-11, BI-PD-12, BI-PD-14, BI-PD-15, BI-PD-16, BI-PD-18, BI-PD-19	BI-PD-13, BI-PD-17

Most concepts embody design solutions that are predominantly only possible to manufacture using AM. For example, lattice structures in bicycle frames, various infills of airless tires, and multicolour embedded into the frame are hard to achieve with other manufacturing processes. The successful manufacturing of 8 prototypes and the final solution using the FDM process showed that the design solutions suggested by the Mapping Methodology could be embodied in physical form.

The second case study showed a successful application of mapping methodology by the inexperienced designer in the context of developing a product made of multiple components. The insights gained from the second case study are summarised in the following points:

- FC method is an adequate design method for function modelling of parts,
- FC method is not an adequate design method for function modelling of assemblies,
- The mapping method enabled the creation of multiple concepts that utilise AM capabilities,
- The mapping method enabled the integration of functions and the creation of innovative solutions.

It can be concluded that the conducted case study provided evidence for supporting the research hypothesis and indicated the suitability of mapping methodology to redesign individual parts of the assembly but is not suitable for function modelling of an entire assembly.

| 7.3 Case Study 3: Toy Car

| 7.3.1 Case study context

The third case study is the development of AM toy car powered by air from the party balloon. The project was purposely conducted to evaluate the Mapping Methodology in the team design activity by novice designers. The secondary purpose of the project is to educate designers participating in the project on the topics of AM and DfAM. The project took place from February 2022 to March 2022 at the University of Zagreb, Faculty of Mechanical Engineering and Naval Architecture.

The design task in the project is to design a toy car that will be manufactured using the FDM AM process. The design requirements were that all parts of the toy car must be made using FDM. The car must be powered by air from the party balloon. And as it is a toy, it needs to be aesthetically pleasing. The project followed the prescribed steps of Mapping Methodology, with the addition of lectures on function modelling, AM and DfAM.

The project was conducted as a team activity. The team was made of two students in the seventh semester of undergraduate studies. Both students are enrolled on a Mechanical Engineering course, specialisation Design of Medical Structures. They did not have any courses about design methods, function modelling, or the generation of concepts during their studies. Therefore, the use of the mapping methodology is their first encounter with systematic design methods. Furthermore, both designers are complete novices in AM and DfAM and had no prior knowledge about either. A graphical overview of the case study is shown in Figure 7.3, while Table 7.5 lists all data sources gathered in this case study enclosed in Appendix G.

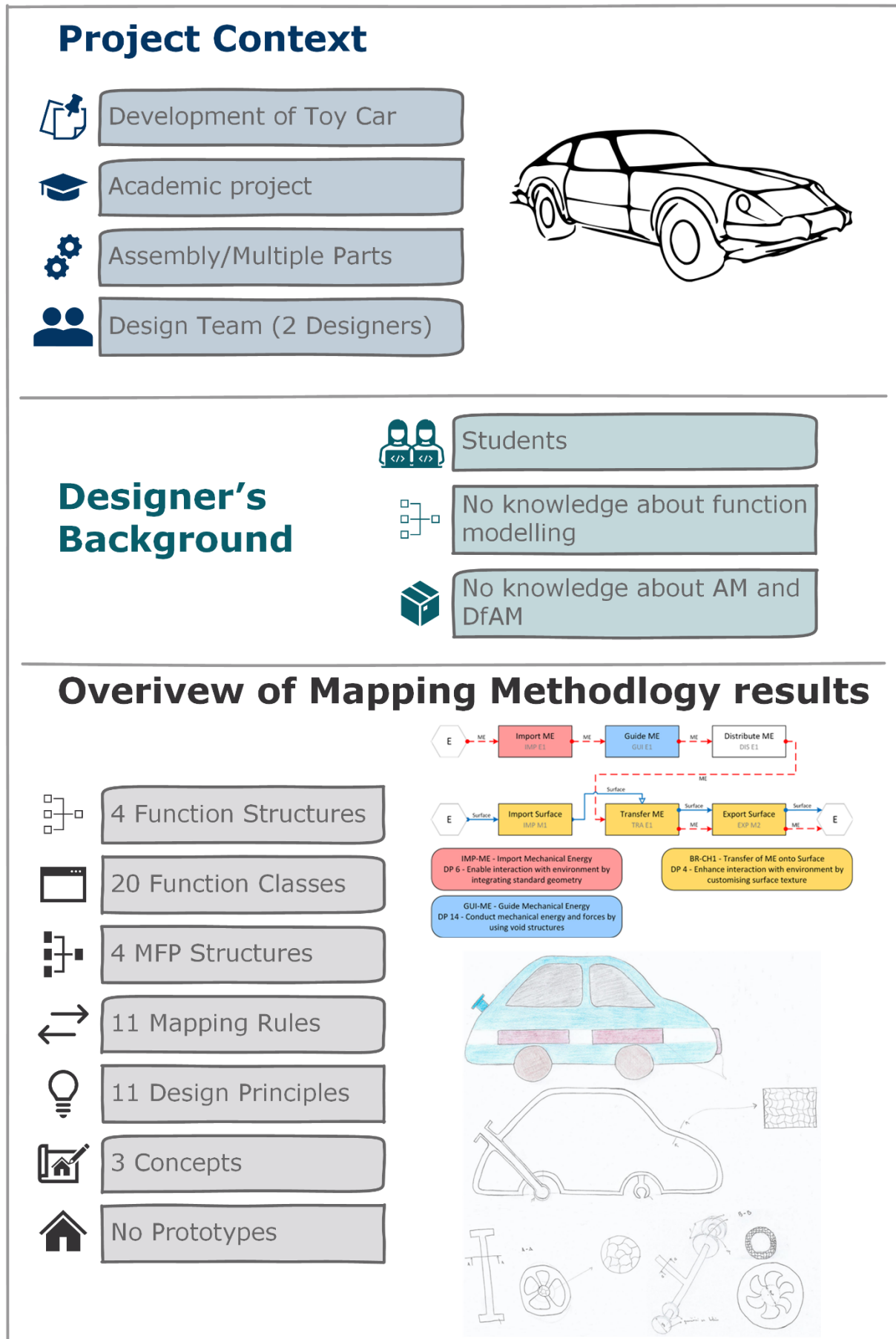

Figure 7.3 Overview of Case Study 3: Toy Car [189]

Table 7.5 List of data sources for Case Study 3: Toy Car

Data ID	Description of data	Data reference
TC-PD-01	Function structure of the toy car	G.1.1
TC-PD-02	Mapped function structure of the toy car	G.1.2
TC-PD-03	Function structure of the wheels	G.1.3
TC-PD-04	Function structure of the propulsion	G.1.4
TC-PD-05	Function structure of the chassis	G.1.5
TC-PD-06	Function structure of the chassis and the propulsion	G.1.6
TC-PD-07	MFP Structure of the wheels 1	G.1.7
TC-PD-08	MFP Structure of the wheels 2	G.1.8
TC-PD-09	MFP Structure of the chassis and the propulsion 1	G.1.9
TC-PD-10	MFP Structure of the chassis and the propulsion 2	G.1.10
TC-PD-11	Concept 1	G.1.11
TC-PD-12	Concept 2	G.1.12
TC-PD-13	Concept 3	G.1.13
TC-ON-01	Project setup notes	G.2.1
TC-ON-02	Observations of FC learning process	G.2.2
TC-ON-03	Observations during function modelling and review of function structures	G.2.3
TC-ON-04	Observations during DfAM and mapping lecture	G.2.4
TC-ON-05	Observations after first mapping	G.2.5
TC-ON-06	Observations of function modelling individual components	G.2.6
TC-ON-07	Observations of mapping individual components and concept generation	G.2.7
TC-IN-01	Interview 1 - Background information	G.3.1
TC-IN-02	Interview 1 - FC Method	G.3.2
TC-IN-03	Interview 1 - Mapping Method	G.3.3
TC-IN-04	Interview 1 - Other information	G.3.4
TC-IN-05	Interview 2 - Background information	G.3.5
TC-IN-06	Interview 2 - FC Method	G.3.6
TC-IN-07	Interview 2 - Mapping Method	G.3.7
TC-IN-08	Interview 2 - Other information	G.3.8

7.3.2 Case study report & analysis

The designers conducting the development of a toy car never used any function modelling technique, and the use of the FC method was their first encounter with function modelling. Hence, the development project started with a comprehensive introduction lecture on functions, function modelling, function structures and the FC method. During the lecture, the designers understood the concept of product functions and how to use FCs to create function structures.

7. Case Study Results

Furthermore, they could comprehend the meaning of all function structures that were used as examples (TC-ON-02). For novice designers to learn what is the FC method and how to use it was fairly easy (TC-ON-02, TC-IN-02, TC-IN-06).

In this case study, the designers had the FM App at their disposal, and all function modelling was conducted using the FM App. However, it was observed designer also took written notes to communicate and brainstorm ideas. The function modelling was done in two ways, firstly on the assembly level and then on the part level.

The function modelling started with the creation of a function structure for the toy car as a single system. The designers created multiple function structures (TC-PD-02), with the majority of them only focusing on the propulsion system and ignoring other functionalities of the toy car. In the beginning, there were errors in choosing the appropriate FC for the given context, but as designers used the FM App to create function structure, no syntax errors occurred. However, it was observed that the designers had issues expressing the overall functionality of the toy car and were trying to model flows of materials that are part of the system itself (TC-ON-03). They were able to express the functionality of the propulsion but had trouble modelling the interaction of the system with the environment. Noticeably, they tried to add a flow representation of the wheels as the external flow entering the system. While using this approach, designers had a common understanding of the toy car's main functions, they were not able to model the full functionality of the toy car, and the subsequent mapping of it was unsuccessful. After reviewing the created function structures, in discussion with the designers, it was decided that they should identify individual components of the toy car and create separate function structures for each. Hence, the function modelling was switched onto the part level, where designers created three separate function structures representing various parts of the toy car.

In the second round of function modelling, the designers created a function structure of the wheels (TC-PD-03) and individual function structures for the propulsion (TC-PD-04) and the chassis (TC-PD-05). When modelling function structures for individual components, designers had no problem expressing their functionality (TC-ON-06). Once they disassembled the overall functionality of the toy car on the smaller units, they were able to review its functionality and combine the function structures of the propulsion and the chassis into a single function structure (TC-PD-06). On the part level function modelling, designers did not have issues expressing the functions of the parts and were able to model and represent the interactions among them using input and output flows. It is interesting to notice that the designers gained an in-depth understanding of the toy car's functions and flows. They used this insight and then combined the two function structures into one (chassis + propulsion) and were even able to further extend

the function structure by adding additional function chains representing the interaction with the object in the case of the crash and representing the visual identity of the toy car.

Because designers participating in the third case study were complete novices in AM and DfAM, a comprehensive lecture on AM and DfAM was given before introducing them to Mapping Method. This was followed by the lecture on Mapping Method, where MRs and DPs were shown and explained to the designer, and the use of FM App mapping functionality was demonstrated. The topic of AM was a novelty for the designers, but they showed an understanding of AM and the DfAM (TC-ON-04). In the case of the mapping method, designers understood the method and were able to apply it (TC-ON-04). However, they reported issues with understanding some of the DPs as some forms and solutions contained in the DPs were unfamiliar to them (TC-IN-03, TC-IN-07).

The mapping process was conducted twice, firstly for the function structure of the entire system and second time for the two function structures of individual components. Firstly, the designers performed mapping on the function structures of the entire system of the toy car. While the application of mapping was partially successful, they could not map the entire function structure. In this mapping, designers wrongly applied some MRs, could not map the entire function structure, were generally displeased with the suggested solutions and were not able to create a concept from the MFP Structures (TC-PD-02). It is interesting to notice that designers also marked some DPs that the MRs did not suggest but they thought it could be used as a solution for their design problem.

In the second mapping, designers mapped the two function structures of the individual components, and from each, two MFP Structures were created. On the MFP Structures of the wheels 3 different MRs and 4 DPs were mapped (TC-PD-07, TC-PD-08), while on the MFP structures of the chassis and propulsion 9 different MRs and 10 DPs were mapped (TC-PD-09, TC-PD-10).

Using the developed MFP Structures, designers created three concepts for the toy car (TC-PD-11, TC-PD-12, TC-PD-13). The concepts are fairly similar and have a lack of details. They embody the suggested AM DPs but with smaller modifications could be manufactured with other manufacturing technologies, except the lattice structures. These issues could be attributed to the designers' inexperience in product development and their unfamiliarity with the AM.

7.3.3 Conclusion & Pattern Matching

The pattern matching technique is carried out to conclude the case study report. Table 7.6 shows the original and rival patterns established in Section 6.4.2 matched with associated

7. Case Study Results

supporting evidence (SE). The dominant patterns with the most supporting evidence are highlighted.

The evidence for the first proposition mostly supports the original patterns showing the suitability of the FC method for function modelling of AM products in team design activity. However, this evidence only indicates the suitability of the FC method for function modelling of parts. Similarly to case study two, the FC method was unsuitable for function modelling on an assembly level. Despite this problem, in this case study, designers could express the product's main functionality but were not able to incorporate the secondary functions of the system. Besides the limitations of the FC method, this could also be attributed to the inexperience of the designers as this was their first encounter with function modelling.

Table 7.6 Pattern Matching for Case Study 3

	Pattern	Rival Pattern
PR1	Designer(s) can create function structure using FC method and through it clearly express the functionality of AM product(s).	Designer(s) are not able to express the functionality of AM products using FC method for creation of function structures.
SE	TC-PD-03, TC-PD-04, TC-PD-05, TC-PD-06, TC-ON-03, TC-ON-06, TC-IN-02, TC-IN-06	TC-PD-01, TC-ON-03
PR2	Designer(s) utilised a variety of AM designs solutions using mapping methodology.	Despite using the mapping methodology, designer(s) utilised a small number of different AM solutions.
SE	TC-PD-09, TC-PD-10, TC-ON-07	TC-PD-07, TC-PD-08, TC-ON-05
PR3	Designer(s) used suggested mapping to integrate multiple functions using one design solution.	Designer(s) did not embrace the function integration and looked for individual solutions for each function.
SE	TC-PD-09, TC-PD-10, TC-IN-03, TC-IN-07	TC-PD-07, TC-PD-08
PR4	Designer(s) created concepts that embody design solutions only or predominantly feasible using AM.	Designer(s) created concepts that are feasible with other technologies besides AM.
SE	TC-PD-12	TC-PD-11, TC-PD-13, TC-ON-07

The second proposition does not have a dominant pattern. The created concepts are rather similar, with a small number of different solutions, even though MFP Structures provide different MRs and DPs. On the other hand, the propulsion system is embodied in three different ways. The lack of a dominant pattern could be attributed to the designers' inexperience in product development.

The third proposition has multiple evidence supporting the original pattern that the mapping method enables function integration. Designers also stated that they feel the mapping methodology enabled them to solve multiple functions with the same AM solution.

The final proposition is predominately supported by evidence for the rival pattern. As the designers are novices in both product development and AM, this is the most likely cause. This can be seen from their responses in interviews, as both designers stated they had issues comprehending the meaning of DPs.

The third case study showed an effective application of mapping methodology by a design team made of two inexperienced designers in the context of new product development. The insights gained from the third case study are summarised in the following points:

- FC method is an adequate design method for function modelling of parts,
- FC method is not an adequate design method for function modelling of assemblies,
- FC method enabled common representation and understanding of function model inside the design team,
- The modality of DPs representation was not suitable for novices in AM and DfAM,
- The mapping method enabled the integration of functions.

To conclude, the evidence suggests the FC method is applicable for representing the functionality of the parts but has limitations in representing the functionality of the entire assemblies. Furthermore, the mapping method did suggest different AM solutions, and designers were able to create concepts that embody those solutions. However, designers were not able to fully utilise the suggested AM solutions due to their inexperience and the limitations of the DPs modality of representation.

| 7.4 Case Study 4: Heat exchanger

| 7.4.1 Case study context

The context of the fourth case study is the use of the mapping methodology to design AM heat exchanger. The case is a part of an evaluation project on the potential use of the AM for manufacturing parts in the processing industry. The project was conducted in collaboration with a company from the central part of Croatia specialising in manufacturing equipment for boiler plants, heat distribution stations and the process industry. The project took place in February and March 2022.

The equipment used in the process industry is highly regulated with the standard and norms that must be followed. The products are mostly made of metal semi-finished products (plates,

7. Case Study Results

flanges, tubes) welded together into a final product. The final products vary in size, from small products (<1 m in size) to large products (>20 m in size). Due to the regulations, size, and standardised products, the AM is not suitable manufacturing technology for this industry at the moment. However, due to advances in metal AM and the complexity of shapes that can be made using AM, the company and its engineers wanted to learn more about AM and evaluate its potential application.

The part of the project that was used as a case study was the design of AM heat exchanger. A single design engineer conducted the design. The designer has 9 years of experience in the design of equipment for the processing industry. His educational background is in product development, so he is familiar with function modelling, although he is not using it in his daily design activities. The designer does not have an experience with the AM. A graphical overview of the case study is shown in Figure 7.4, while Table 7.7 lists all data sources gathered in this case study enclosed in Appendix H.

Table 7.7 List of data sources for Case Study 4: Heat Exchanger

Data ID	Description of data	Data reference
HE-PD-01	Initial function structures of heat exchanger	H.1.1
HE-PD-02	Function structure of heat exchanger	H.1.2
HE-PD-03	Initial MFP Structure of heat exchanger	H.1.3
HE-PD-04	MFP Structures of heat exchanger	H.1.4
HE-PD-05	Concept 1	H.1.5
HE-PD-06	Concept 2	H.1.6
HE-PD-07	Statement	H.1.7
HE-ON-01	Project setup notes	H.2.1
HE-ON-02	Observations during methodology introduction	H.2.2
HE-ON-03	Observations during first review	H.2.3
HE-ON-04	Observations during second review	H.2.4
HE-IN-01	Interview - Background information	H.3.1
HE-IN-02	Interview - FC Method	H.3.2
HE-IN-03	Interview - Mapping Method	H.3.3
HE-IN-04	Interview - Other information	H.3.4

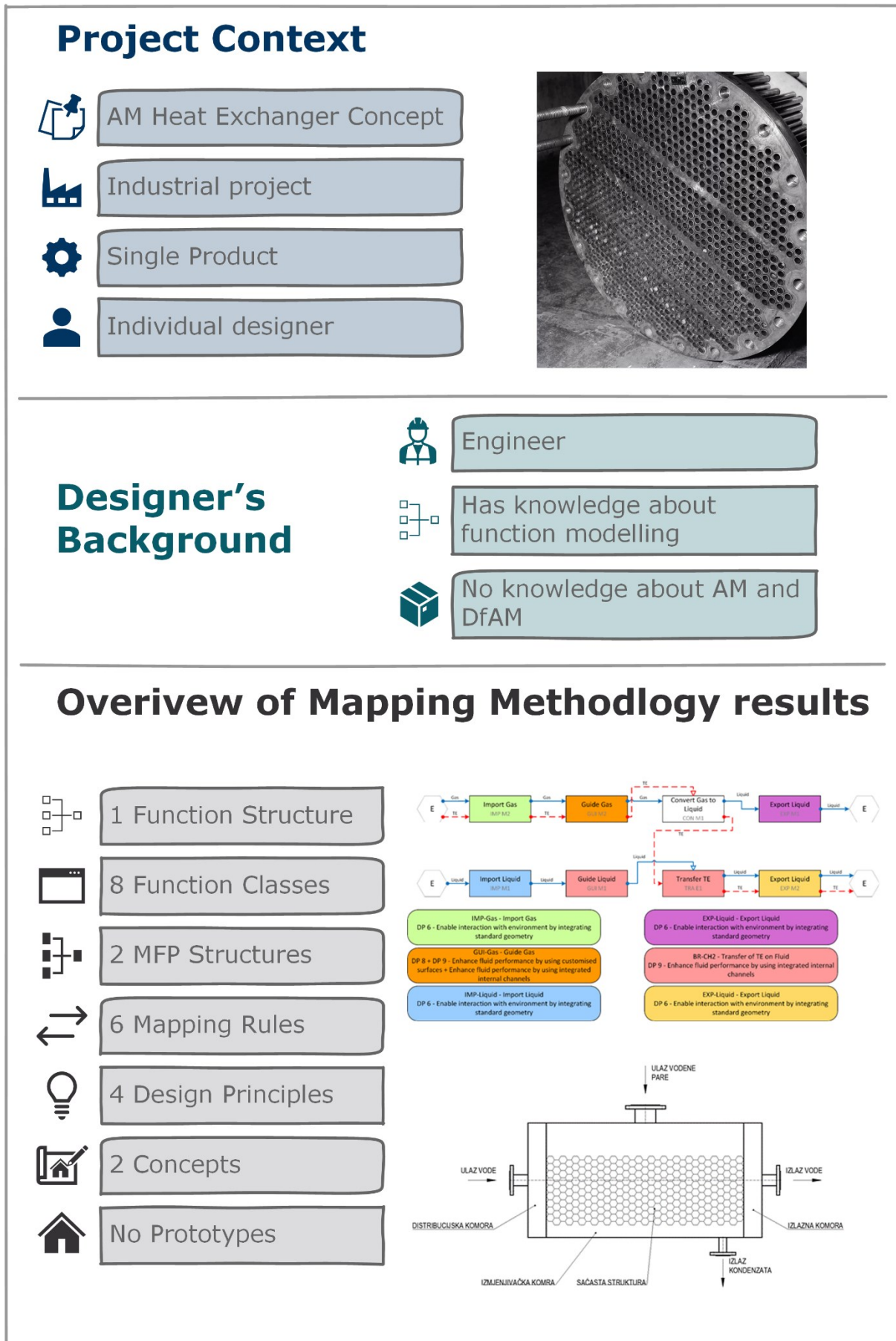

Figure 7.4 Overview of Case Study 4: Heat Exchanger [190]

7.4.2 Case study report & analysis

In the fourth case study, mapping methodology was used for the design of AM heat exchanger. Before the project, the designer was familiar with function modelling and function structures but had never used predefined vocabulary and strict modelling rules. Therefore, a short introduction lecture on the FC method was given. During the lecture, the designer had no issues understanding the concept of FCs and could comprehend the meaning of the examples given in the lectures (HE-ON-02, HE-IN-02). However, during function modelling, there was an initial issue of understanding where the designer wanted to model the function structure as a technical process replicating the real-life physical process. Hence, additional instructions to idealise the system where all the energy is transferred from one flow to another were given. The thinking in abstract terms rather than technical was not a problem for the designer as the FCs description was clear to him. The case study showed that experienced designer could easily learn the FC method. Arguably, the learning process was the fastest in this case study. This can be attributed to experience of the designer, but also could be influenced by the simplicity of the product.

The designer conducted function modelling in two iterations. In the first iteration, the designer created two function structures (HE-PD-01). The designer had an issue with the representation of functions *Convert* and *Transfer TE*, as he tried to describe them as a technical process and not an ideal system. Hence, he wanted to add residual flows of TE and model energy losses. Furthermore, the designer did not follow the defined representation of input and output flows from the function block. After the additional discussion with the designer (HE-ON-03), he created a new version of the function structure that was fully compliant with the FC method, and he could express the overall functionality of the heat exchanger (HE-PD-02). The designer did not report any major issues in applying the FCs except the issue discussed above. The designer could express the entire functionality of the heat exchanger using FCs. The designer later stated the FCs were very clear, and he did not have a problem in understanding and applying them. He also stated that he sees the benefit of using such an approach in product development.

Due to organisational reasons, the mapping method and AM DPs were introduced to the designer at the same time as the FC method. Although the designer did not have previous experience in AM, no extra lecture on the topic was given. The designer was introduced to the MRs, DPs, and how to use the mapping inside the FM App. In applying the mapping method designer had problems in the first iteration. However, this was not related to the mapping method itself but rather a lack of attention during the lecture. After the additional explanation

of the mapping method, the designer understood it and was able to map created function structure.

The mapping was conducted in two iterations. Firstly, the designer conducted only one-to-one mapping, where he tried to apply MR and DP for each individual function in the function structure (HE-PD-03). This was not in accordance with a prescribed mapping procedure. The designer was not satisfied with the result and asked for additional clarification as mentioned previously. The mapping procedure was once again explained (HE-ON-03), and in the second iteration, MRs were properly applied, and two MFP Structures were created (HE-PD-04). Both MFP Structures utilise the same 6 MRs but use a different combination of DPs. Because the designer created only one version of the function structure, and as the function structure contained only 8 functions, there was a limited number of MRs that could be applied.

Two concepts of AM heat exchanger were created. The first concept is based on the hexagonal lattice structure with internal channels to increase the surface for condensation (HE-PD-03). The second concept uses geometry inside the channels to achieve turbulent flow and increase the heat exchange rate (HE-PD-04). And while crated concepts are related to the MFP structures, the designer stated he didn't use them much, as he already had an idea of how to use AM to create the heat exchanger (HE-IN-03). Therefore, no major conclusion on how MFP structures influence concept generation can be derived.

| 7.4.3 Conclusion & Pattern Matching

The pattern matching technique is carried out to conclude the case study report. Table 7.8 shows the original and rival patterns established in Section 6.4.2 matched with associated supporting evidence (SE). The dominant patterns with the most supporting evidence are highlighted.

In the fourth case study, evidence supports the original pattern for the first proposition indicating the suitability of the FC method for function modelling of parts. While the designer firstly tried to create a function structure with flows that resemble technical process, after additional instructions to think about the function in more abstract terms as an idealised system, he could express the product's functionality.

On the other hand, for the second proposition, evidence supports the rival pattern. As the designer created only one function structure, and it had a small number of functions, a limited number of MRs and DPs could be applied. This is related to the type of product the designer was modelling, but also, he did not try to create alternative function structures and MFP structures. Furthermore, the design fixation and experience of the designer could have

7. Case Study Results

influenced this phenomenon, as in everyday design activities, the designer must satisfy the norms and strict design requirements, thus having limited possibilities for experiments and innovations in the design of heat exchanger.

Table 7.8 Pattern Matching for Case Study 4

	Pattern	Rival Pattern
PR1	Designer(s) can create function structure using FC method and through it clearly express the functionality of AM product(s).	Designer(s) are not able to express the functionality of AM products using FC method for creation of function structures.
SE	HE-PD-02, HE-ON-03, HE-ON-04, HE-IN-02	HE-PD-01
PR2	Designer(s) utilised a variety of AM designs solutions using mapping methodology.	Despite using the mapping methodology, designer(s) utilised a small number of different AM solutions.
SE		HE-PD-04
PR3	Designer(s) used suggested mapping to integrate multiple functions using one design solution.	Designer(s) did not embrace the function integration and looked for individual solutions for each function.
SE	HE-PD-04, HE-PD-05, HE-PD-06, HE-IN-04	
PR4	Designer(s) created concepts that embody design solutions only or predominantly feasible using AM.	Designer(s) created concepts that are feasible with other technologies besides AM.
SE	HE-PD-05, HE-PD-06	

For the third and fourth prepositions, data (MFP structures and concepts) supports the original patterns. However, the designer himself stated he already had concepts in mind, and he did not use the MFP structures in concept generation. For this reason, this data is not objective, and no conclusion can be derived from it.

The fourth case study showed an application of mapping methodology by the experienced designer in the context of the redesign of an existing component. The insights gained from the fourth case study are summarised in the following points:

- FC method is an adequate design method for function modelling of parts,
- The designer could easily express product functions and overall product functionality using the FCs,
- The mapping method had a limited influence on the concept generation process.

7.5 Cross case study analysis

After analysing each case study individual, they are compared in cross case study analysis. Cross case study analysis summarises the observations, provides answers for propositions not answered in a single study, and replication of patterns increases the validity of results [181]. Table 7.9 summarises all patterns observed across the four case studies. For all four propositions, original pattern was supported by the majority of case studies. For the first pattern, all four cases supported the original pattern. In the second proposition, two cases supported the original pattern, one supported the rival pattern, and no dominant pattern emerged in one case. Three cases supported the original pattern for the third proposition, while one case had to be excluded due to bias. The same case is also excluded from the fourth proposition, where two cases support the original pattern, and one case supports the rival pattern.

Table 7.9 Patterns from all case studies

	Pattern	Rival Pattern
PR1	Designer(s) can create function structure using FC method and through it clearly express the functionality of AM product(s).	Designer(s) are not able to express the functionality of AM products using FC method for creation of function structures.
CS	GE, BI, TC, HE	
PR2	Designer(s) utilised a variety of AM designs solutions using mapping methodology.	Despite using the mapping methodology, designer(s) utilised a small number of different AM solutions.
CS	GE, BI	HE
PR3	Designer(s) used suggested mapping to integrate multiple functions using one design solution.	Designer(s) did not embrace the function integration and looked for individual solutions for each function.
CS	GE, BI, TC	
PR4	Designer(s) created concepts that embody design solutions only or predominantly feasible using AM.	Designer(s) created concepts that are feasible with other technologies besides AM.
CS	GE, BI	TC

Based on the patterns observed and gathered evidence following conclusion can be drawn:

1. The FC method, as a part of mapping methodology, is an appropriate method for function modelling of AM parts as it enables designers, both novices and experienced ones, to express the functionality of AM parts and create a function structure following the method's framework. However, the issues in using the FC method for function modelling of assemblies were encountered that require further investigations.

7. Case Study Results

2. The mapping methodology provides a variety of solutions for individual functions or function blocks, thus enabling the utilisation of AM possibilities, and consequently their embodiment through concept generation and establishment of preliminary layout.
3. The mapping methodology supports function integration by providing MRs for blocks of functions but also by providing suggestions to use the same DP for two or more functions in the function structures, thus enabling designer to solve sequence of functions in a single component or design feature.
4. The mapping methodology enabled designers to think additively and embody the unique AM possibilities, through the utilisation of AM DPs, in both concepts and physical objects.

Chapter 8 is a part of Descriptive Study II, and it is a reflection on the conducted research. Firstly, each of the four research questions is addressed by discussing Function Class Method, Mapping Method, AM Design Principles and Mapping Rules. Furthermore, the overall Mapping Methodology is compared with the list of important characteristics of early phase DfAM methods. Additionally, the chapter reflects on the validity of the conducted research and its results through the validation square.

8.1 Function modelling of AM products

RQ1: What are the distinguished features of function models of AM products, and how should the function structures of AM products be expressed?

The first RQ investigated the features of AM products' function models and the elements of their representation in the form of function structures to enable the expression of AM products' functionality in a formal and repeatable manner. The RQ emerged from the research goal of developing a systematic approach for the early phases of AM oriented design process. The goal was motivated by the growing need for design support for early design phases among the design practitioners [9] and the technical and economic benefits provided by the systematic design processes [18,28–32]. Moreover, function modelling is the backbone of many prescribed systematic design processes, and function models, together with graphical representation in the form of function structures, is their essential part. However, the function modelling in the area of DfAM is still not thoroughly investigated, and only a handful of approaches consider functions in DfAM [37,39,40].

Therefore, the first step was to investigate what are the characteristics of AM products function models by using the literature recommendations to conduct the function modelling. The existing approaches for function modelling found in the literature were developed through analysis of electro-mechanical consumer products [118,121,146], but claim a universal application across the domains. However, the functional models of this type of product are characterised by the emphasis on the flows of electrical energy and manipulation of signal flows that are used, in combination with other types of flows, to describe the functionality of the

product [126]. This limits their applicability in the domains where there is a noticeable lack of these flows, such as in the domain of AM products.

The empirical study described in Section 3.3 created function structures for the set of 45 AM products. By observing these function structures and the occurrence of the number of flows (Figure 8.1) and functions (Figure 8.2) in them, it can be seen that the flows of electrical energy and control signal were not existent in the observed set of AM products. This is the consequence of the current state of AM and its limitation on manufacturing electronic components. The emphasis of AM products function models was on the flows of *mechanical energy* and material, most notably *Solid*, but also *Gas*, *Liquid* and *Human*. The most common functions are the ones for channelling and converting flows of material and energy (*Import*, *Export*, *Guide*, *Transfer* and *Convert*). Also, the function *Allow DOF* is widespread, as the AM products are often built as an assembly in a single build or incorporate different flexible features enabled by geometrical complexity and multi-material structures. Similarly, the function *Position* is often used to describe the customisability of the AM products for the particular use case or individual user when the flow of material is imported inside the system's boundaries. Hence, the answer to the first part of the RQ is:

The distinguished features of AM products' function models are:

- The emphasis on the flows of mechanical energy,
- The emphasis on the flows of material (*Solid*, *Human*, *Gas*, *Liquid*),
- The emphasis on the functions of channelling and converting flows of material and energy (*Import*, *Export*, *Guide*, *Allow DOF*, *Transfer*, *Convert* and *Position*)
- Lack of electrical energy and control signal flows and related functions.

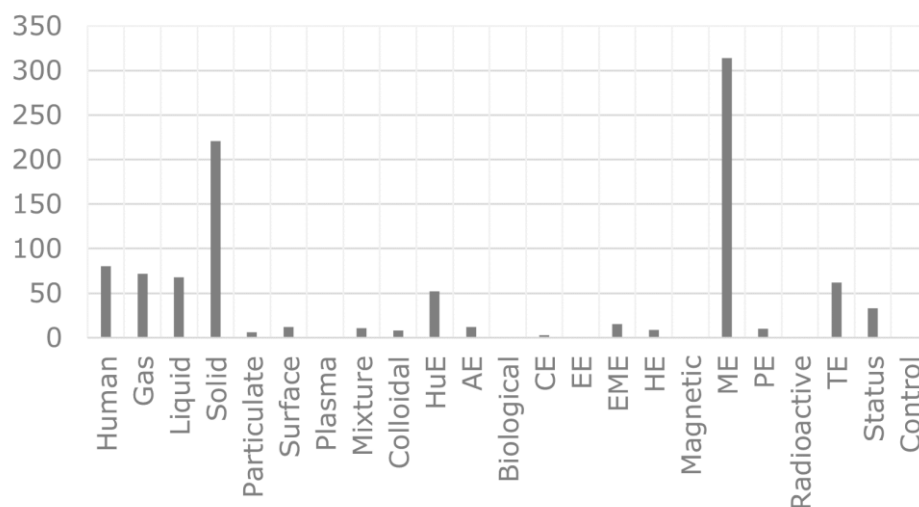

Figure 8.1 Occurrence of flows in the performed analysis

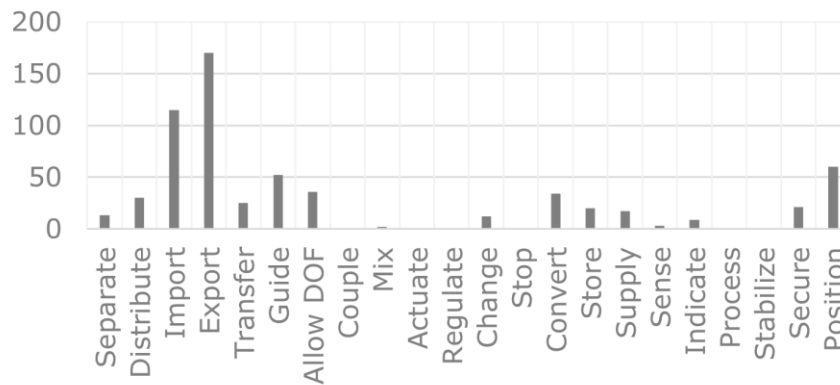

Figure 8.2 Occurrence of functions in the performed analysis

The notable difference in features of AM products' function models compared to electro-mechanical products raised the question of whether the existing function modelling approaches are suitable for DfAM and how the functionality of the AM products should be expressed. The mapping methodology requires function structures to express AM products' functionality in a repeatable manner. However, one of the common critiques of function structures is the lack of unique representation [109]. The empirical study of AM product functions using the existing function modelling approaches (Section 3.2, Figure 3.5) demonstrated the issue. Therefore, to answer the second part of the first RQ, the FC Method for function modelling of AM products is proposed.

The FC method tackles the above-described problems through a novel approach to functional modelling that provides a repeatable representation of function models with consistent representation through FCs. The FCs act as a template for the graphical modelling of function structures while providing the formalism and consistency needed for the computational processing of function models. The concept of FCs builds on the existing body of knowledge on functional modelling and integrates hitherto developed vocabularies and rules into one coherent approach.

The main benefits of the proposed approach are the categorisation of functions and their interactions with the flows on a block level. The FCs provide a graphical template for functional modelling with its formal form in a class description and enable consistency in function structure representation. FCs should ease the functional modelling process, especially for novice designers who often struggle with creating inputs and outputs flows of the function block. The approach enables the creation of different functional variants. At the same time, the consistency of representation enables a more straightforward comparison of different models, facilitates the use of function models across design stages, supports easier archival and retrieval of previous designs, and supports computational processing. Furthermore, the multiple FCs for

a single function can stimulate the designer's creativity and be an inspiration for a new function model. By using different combinations of FCs for the same function or set of functions, the designer can create multiple function structure alternatives.

Another benefit of the proposed approach and developed protocol for derivation of FCs is the possibility of expanding the FCs into other domains using the described protocol. Thus, providing the extensibility of the proposed modelling language [191]. This will enable the mean for the future development of FCs in other domains and could lead to the development of a universal modelling language that will support domain independent modelling and cross-domain comparison and search for partial solutions. Furthermore, one can develop a new dedicated set of FCs, based on proposed rules or by modifying them for a particular need to use FCs as storage of design knowledge. By doing so, one can store the knowledge of the individual, design team or company to support knowledge modelling and its archival for future use.

Compared with the Functional Basis [118], FCs provide an additional level of formal definitions of functions and flows. The Functional Basis depends on the designer's interpretation of the textual description of functions and flows and does not provide guidance on defining input and output flow. On the other hand, the FCs provide a definition of inputs and flows for each function, thus ensuring the consistency of the model representation. Furthermore, the Function Basis contains three levels of vocabulary, and FCs are based on its modified secondary level, as previous research showed the expressiveness and optimal abstraction of this level are adequate for functional modelling [126]. Furthermore, FCs expand each function through the possibility of modelling multiple combinations of inputs and outputs, depending on the function intention inside the system.

On the other hand, compared to Sen et al.'s modelling rules [129], FCs contain the logic of conservation laws and similar rules of representation. While Sen et al. categorise rules into 6 categories for different modelling stages, in FCs, rules are categorised in primary and modelling rules. But as the primary rules are contained in each FC, only modelling rules for function chains need to be checked during the creation of the function structure. Furthermore, as FCs focus on defining function block level, they cannot be directly compared to the design grammars of Sridharan & Campbell [127] and Nagel et al. [112], as their approaches focus on defining the syntax of function chains. However, both design grammars and FCs act as templates for creating function structures. During the development of FCs, some characteristic patterns of function chains were noted, so it can be argued that similar design grammar can be developed based on the FCs.

FCs are mostly similar to “Form follows Form” stage one grammar rules proposed by Bohm et al. [128] and triple notation and function templates of Sen et al. [166]. Bohm et al.’s rules allow a semi-automated approach to functional modelling as they define each function's input and output flow in a textual manner. While improving the formal definition of Function Basis vocabulary, Bohm et al.’s approach does not provide additional formalism regarding the type of flows on which function operates, nor does it recognise different types of inputs and outputs as FCs do. On the other hand, Sen et al.’s approach recognises the type of input and output flows (material, energy, signal) and connecting rules between function blocks, with one description for each function. Moreover, similarly to FCs, they provide a graphical template for each function block. However, FCs, through definitions of enabling and auxiliary flows and variations of the FCs description depending on the operating flow and function intentions, provide a more detailed description of function blocks and their graphical template.

| 8.2 Design Principles for AM

This section is based on the journal paper [161].

RQ2: What are the design principles based on the capabilities and limitations of additive manufacturing?

The second RQ aimed to review and consolidate the different sources of AMK for early design phases and, through empirical research, investigate the AMK stored in existing AM products used to solve the product’s functions. Today literature provides different sources of AM design knowledge (AMK) in various formats aimed at different phases of the design process. The AMK for early design phases is mostly opportunistic in nature and emphasises the possibilities of AM, with little or no referral to its limitations. However, the hitherto developed sources of AMK for the early design phase, most notably the crowdsourced AM DPs [48,103,104] and design heuristics [14,47], are not explicitly oriented on the functions of the products but rather on solving the generalised design problem and design requirements. On the other hand, function-based AMK sources reported in the literature [37,39,40] are not fully developed or publicly available. Therefore, through a review of existing sources and inductive empirical study, the second RQ is addressed with the developed list of 32 AM DPs.

DPs provide a source of opportunistic AMK for the early phases of the design process and are intended to be used with function-based design methods. The DPs are formulated to balance the generalisation of DPs and their specificity regarding particular functions. Because some

AM features and DPs can solve multiple functions, the syntax avoids mentioning functions in DP definitions. Formulating DPs to include mention of a particular function would lead to the extensive expansion of the number of DPs, which would be exhausting to comprehend with little additional value to the stored AMK. Similarly, a lack of reference to specific materials and AM technologies gives universality to the derived DPs and emphasises their focus on early design phases.

This logic can be seen in the group of principles referring to the functionality of interaction with the environment (#DP4, #DP5, #DP6, #DP7). For example, suppose the expression “Enhance interaction with environment” was replaced with a particular function, in this case with 15 different functions (e.g., Import Gas, Import Liquid, Secure Solid, etc.), instead of four DPs the list could have contained 60 DPs (15 functions x 4 AMK formulations) without providing any additional benefits. On the other hand, referring to AM capabilities through only a generalised description could hinder some subtle AM capabilities. For example, the AM feature mentioned in #DP7 (use custom geometry to fit the use case) is a broad characteristic of AM, and features referred to in #DP4, #DP5, and #DP6 could be considered sub-features of custom geometry. However, by referring to surface texture (microscale geometry), surface features (macroscale geometry), and standard geometry that could be incorporated directly into a part, a customisable geometry characteristic of AM is explained with the specificity for a particular use case. For example, #DP6 is applicable for a broad set of functions, while #DP4 and #DP5 are more specific and refer to design contexts, thus providing specific information for these use cases. The same logic was applied in the definition of the rest of the DPs as well. These subtle differences could be emphasised with additional modalities of AM DPs representation, such as examples, pictures, or 3D model [42] that are not part of this research.

The derived DPs are similar to the existing crowdsourced AM DPs of Perez et al. [48,103] and AM design heuristics [47,192]. However, there are notable differences in the formulation, intended use, and scope of the AMK they contain. When the formulation of the three knowledge explications is compared, the derived function-based AM DPs are similar to crowdsourced DPs, as a similar syntax is used. Hence, both sets of DPs provide clear instructions for the designer on which action needs to be performed in a particular use case. On the other hand, the design heuristics are presented through a more generalised descriptive formulation and do not provide specific guidance for solving the product functions but rather provide a description of directions the designer could take to explore the AM design space.

If the intended use is observed, the derived DPs are similar to AM design heuristics, as both are focused on the early design phases. Crowdsourced DPs, due to the broader AMK they

contain, can be used across the design process. The notable difference is in the way these sources of AMK are used. Neither heuristics nor crowdsourced DPs provides a mean for systematic application of AMK. Still, designers must go through each heuristic or crowdsourced DP and evaluate if they can be applied in their context. On the other hand, the developed DPs are a part of the overall mapping methodology that enables systematic search through MRs and application of DPs.

Finally, the three approaches involve different scopes of AMK. The crowdsourced DPs provide the broadest AMK, which, besides design solutions, provides guidance for conducting and improving the design process and guidance for detail design to ensure the printability of created designs. On the other hand, AM design heuristics only contain knowledge about conceiving and improving design solutions, and in that view, the derived DPs are very similar to heuristics. However, they contain only design knowledge that can be related to functions and does not refer to design requirements (e.g., recyclability, weight, or aesthetics) in the manner of heuristics.

| 8.3 Function to form relations in AM products

RQ3: What are the relations between AM design principles and product functions in existing AM designs, and how can they be formalised in the form of mapping rules?

The paradigm “form-follows-function” is often used in design research and practice [29]. However, the relations between functions and AM based forms have not been thoroughly studied in the design research so far. Hence, the third RQ investigated these relations through an inductive approach based on the premise that form-to-function relations extracted from existing designs can be reversed and used in the new product development process to conduct function-to-form mapping [51]. The RQ is addressed through 42 derived MRs that relate functions or blocks of functions with AM DPs as an intermediate form of representation.

The purpose of the MRs is to aid designers in finding the AM solutions for the given design problem. The MRs enable designers to detect characteristic blocks of functions, flows or individual functions and map them with potential solutions in the form of AM DPs. There are multiple potential benefits of using MRs. First of all, the MRs enable designers to explore the AM design space. This is achieved through multiple suggestions of DPs for the given functionality of the product and is especially beneficial for novice designers and designers unfamiliar with AM. By systematically and iteratively applying the MRs and mapping the DPs

onto function structures, designers can explore a variety of potential solutions. The MRs can help designers discover new and innovative solutions by suggesting solutions designers might not intuitively think off. Secondly, MRs suggest possible candidates for function integration through block and flow rules by suggesting DPs that can solve multiple functions at once. Similarly, when the same DP is suggested for different functions inside the function structure, they can also be potential candidates for function integration.

The MRs also have their limitations. Firstly, the MRs are based on inductive empirical research and contain only the relations between functions and forms observed in the pool of existing AM products. Therefore, they do not necessarily describe the entire AM design space of function-to-form relations, and designers could and would come up with new and intuitive solutions not contained in the current set of MRs. For this reason, the MRs are not closed set and would require an update in the future to describe an extended set of possible function-to-form relations. Secondly, the number of MRs and the complexity of the block and flow rules make them challenging to use in the manual pen & paper approach, thus requiring the computational support tool. The developed FM App provides such support and enables the directed search of possible MRs for the given function block. However, the application of the MRs inside the FM App currently depends on the designer and their interpretations of the rules. Hence, the designer could either wrongly apply the rule or not review all possible mapping combinations and explore only a part of the design space. Because the MRs have a formal description, a computational tool could be developed whose algorithm can find all possible mapping combinations (e.g., [53]). Furthermore, with a big enough data set and machine learning, these combinations could be reduced to exclude the unfeasible mappings or find only compatible mapping for a given set of design criteria, for example, by using design patterns in analogy [193], design performance metrics [194], functional similarity [195], critical function chain [196] or some other approach.

Each MR describes relations between one or more functions and one or more AM DPs. These relations can only be compared to a similar approach – the function-oriented systematisation of multi-material AM [39,40]. In this approach, relations between the DPs and functions are described using the matrix of general functions. The matrix's first column and top row contain definitions of flows and functions, and the matrix cells are populated with the DPs capturing the relations between functions and DPs. While the matrix enables an easy overview of function-DPs relations, it is limited to only capturing relations between the single function and DPs, and cannot be used to describe many-to-one and many-to-many relations as MRs can.

The derived MRs are mostly similar to the grammar rules for mapping product functions with components [53]. The rules are used for mapping product functions to create a so-called “Configuration Flow Graph”. The rules enable the replacement of one or more function blocks with one or more components. This is similar to MRs blocks and individual rules. However, while the grammar rules enable the replacement of one function or block of functions with more than one component, MRs enable the integration of DPs and their simultaneous application. The most noticeable difference between the two sets of rules is that the grammar rules are not generalised, and for each unique observation, a separate rule exists. Hence from the set of 23 products, 189 rules were derived. On the other hand, the MRs have a generalised formulation to reduce the total number of rules. This significantly reduced the number of MRs but required additional attention and careful application.

| 8.4 Function integration and embodiment of AM design solutions

RQ4: How can mapping rules be applied to enable function integration and embodiment of design solutions?

The fourth and final RQ investigated the overall design support for early design phases to enable function integration and embodiment of AM design solutions. The RQ is addressed through the proposed Mapping Methodology, its theoretical framework, and the computational prototype framework – FM App. The mapping methodology combines the FC Method and Mapping Method into an integrated framework that prescribes the application of MRs and related DPs through which function integration and embodiment of design solutions are enabled.

The function integration is achieved in two ways, primarily through suggested MRs and secondly through suggestions to use the same DP for two or more functions in the function structure, thus enabling the designer to solve a sequence of functions in a single component or design feature. The MRs enable the primary function integration through the block and flow rules. The block rules suggest the integration of characteristic function blocks, while the flow rules suggest the integration of function blocks connected with the characteristic flow. These MRs enable designers to quickly identify possible blocks of functions that can be fulfilled with a single design solution. This type of function integration is the most common one in the proposed Mapping Methodology as can be seen in the results of the described case studies (Chapter 7).

The secondary function integration can be achieved when the same DP is used for generating a single design solution to fulfil two or more functions mapped with different MRs. This type of function integration mostly occurs when function blocks are mapped with individual MRs. When two or more function blocks are mapped with individual MRs and with the same DP, they are a candidate for function integration. This type of integration is not explicitly suggested by the Mapping Methodology, but it rather relies on the designer's reasoning to integrate such function blocks.

The limitation of the methodology regarding function integration is that it does not consider the compatibility of the DPs with the AM process that will be used. Therefore, while MRs can suggest integration for two or more function blocks, the suggested DPs could be incompatible with an AM process to be used thus requiring embodiment in two or more components where each component integrates separate function blocks, in other words, the modularisation of the product due to manufacturing constraints. This limitation could be addressed by adding additional information regarding the compatibility of DPs with each of the seven categories of AM processes. The Mapping Methodology could then use this information in a mapping process to limit suggested DPs depending on the AM process.

The second part of the RQ4 considers the embodiment of design solutions. The Mapping Methodology through the set of DPs enables the embodiment of design solutions used to fulfil the mapped functions or function blocks. The conducted case studies showed that designers successfully used the suggested DPs, and applied AMK stored in them to create design solutions based on the capabilities of AM. The design solutions are embodied in the concepts that are compliant with the current state of AM technology. Furthermore, the manufacturing of prototypes in case studies one and two showed that the created design solutions could be successfully realised in physical objects.

The AMK stored in DPs is represented through the title and short description of DPs. And while designers participating in case studies successfully used these modalities of AMK in the process of generating design solutions, during interviews, some stated they had problems with understanding the DPs in some cases. This is the limitation of the current set of DPs that needs to be addressed in the future through the development of additional modalities of DPs and AMK representation through physical models, pictures, examples, and other forms.

8.5 Characteristics of the Mapping Methodology

To further reflect on the Mapping Methodology, it is compared with the necessary qualities a DfAM method for early design phases should have [14,197]. The necessary qualities are described through a set of 18 characteristics considered important among researchers in the area of early DfAM. The Mapping Methodology is compared to these characteristics in Table 8.1.

Table 8.1 Comparison with the list of Important Characteristics of Early Phase DfAM Methods [14,197]

Characteristics of Early-Phase DfAM Reflection	Supporting data
<p>? Increases the number of AM ideas generated The quantity of generated ideas is associated with the belief that it increases the chance of finding better ideas [164]. While all case studies showed 2 or more generated concepts, and CS1 and CS2 indicate the mapping methodology can increase the number of generated ideas, a controlled validation is needed to verify this characteristic.</p>	[CS1, CS2]
<p>? Increases the quality of AM ideas generated The quality measures an idea's feasibility and does it meet the design specifications [164]. The CS1 and CS2 included the evaluation, and the embodiment of concepts indicates the mapping methodology can improve the quality of generated ideas. However, a controlled validation is needed to verify this characteristic.</p>	[CS1, CS2]
<p>? Increases the variety of AM ideas generated The variety measures explored design space, where the similarity of ideas points to the low variety [164]. This measure is contradictory in the conducted case studies, and it is not clear how this characteristic is reflected, thus requiring a controlled validation.</p>	[CS1, CS2, CS3, CS4]
<p>? Increases the novelty of AM ideas generated The novelty measures how an unexpected idea is compared to others [164]. While all case studies showed the novelty of ideas to some degree, as each case study conducted a different design task, the novelty cannot be fully assessed. Therefore, a controlled validation is needed to verify this characteristic.</p>	[CS1, CS2, CS3, CS4]
<p>✓ Is easy to learn how to use In all case studies, designers reported no significant issues regarding learning how to use the Mapping Methodology. Furthermore, the observation of the designers and the results of their design process further support this characteristic.</p>	[CS1, CS2, CS3, CS4]
<p>✓ Is easy to use In all case studies, designers reported the methodology, as well as the FM App, were easy to use. Minor issues could be contributed to the necessary learning curve. The observation of the designers and the results of their design process further support this characteristic.</p>	[CS1, CS2, CS3, CS4]
<p>✓ Is useful early in the design process The positioning of the mapping methodology inside the overall design process and the use of function modelling as a first step of the methodology ensure its usefulness. This characteristic is also supported by analysed case studies, where designers used the mapping methodology for both redesign and original design tasks.</p>	[CS1, CS2, CS3, CS4]
<p>✓ Provides the information necessary early in the design process This characteristic is the internal construct of the mapping methodology. As it provides information regarding functions, AM DPs and relations between them, the characteristic is achieved.</p>	[IC]

✓	Structured in a useful way	[CS1, CS2, CS3, CS4, IC]
	The mapping methodology follows the prescribed steps and is organised into three main parts: function modelling, mapping, and generation of concepts. This enables easy application of the methodology, as seen in the conducted case studies.	
✓	Structured in an easy to understand way	[CS1, CS2, CS3, CS4, IC]
	This characteristic is related to the previous characteristic. The structure of the mapping methodology provides an easy overview of its main parts and the steps they contain. The conducted case studies showed designers did not have problems with its understanding.	
✓	Offers a comprehensive view of the capabilities of AM	[IC]
	The DPs, as a part of the mapping methodology, provide a comprehensive overview of the AM capabilities for the current state of the AM technologies.	
✓	Offers opportunistic AM information	[IC]
	The AMK stored in the DPs contains opportunistic AM information, as the aim of the mapping methodology is to enable designers to explore the AM design space and create new creative and innovative solutions based on the unique AM capabilities.	
✘	Offers restrictive AM information	[IC]
	The AMK stored in the DPs does not contain restrictive AM information. As the aim of the mapping methodology is to stimulate designers' creativity, such restrictive information could limit the design freedom needed in the early design phases.	
✘	Provides information in a variety of formats	[CS3, IC]
	For FCs and MRs there is both textual and graphical description, while for the DPs there is only textual description. As shown in CS3, where the designers had some issues with understanding of DPs, additional modalities for representing DPs are needed.	
✘	Is applicable to both parts and assemblies	[CS2, CS3, IC]
	The mapping methodology is applicable for the design of parts and individual components of the assemblies, but it is not applicable for the design of the entire assembly. The issues with the design of assemblies are shown in CS2 and CS3.	
✓	Is AM-process and material independent	[IC]
	The information about AM stored in the DPs is AM-process and material independent and does not refer to any particular AM technology. However, not all DPs are feasible with every AM process due to each AM process's different characteristics.	
✓	Is useful for AM-Novices	[CS1, CS2, CS3, CS4]
	Case studies 3 and 4 indicate the usefulness of the mapping methodology for AM-Novices as they used it successfully to create AM concepts. The CS1 and CS2 included designers who were not complete AM-Novices and had some AM experience using it successfully.	
?	Is useful for AM-Experts	[CS1, CS2]
	The mapping methodology was not tested with the genuine AM-Experts. However, the CS1 and CS2 included designers with some, albeit limited, AM and DfAM experiences who successfully used the mapping, thus suggesting the usefulness of the methodology for AM-Experts.	
<p>✓ – Data support, ? – Unclear or contradictory data support, ✘ – No data support/Not applicable CS1 – Case Study 1, CS2 – Case Study 2, CS3 – Case Study 3, CS4 – Case Study 4, IC – Internal Construct</p>		

As can be seen from the table, the mapping methodology has fulfilled 10 out of 18 characteristics. For further 5 characteristics, there is a partial fulfilment, and 3 characteristics are not achieved. The 4 characteristics regarding quantity, novelty, variety and quality of

generated ideas could not be properly tested using case study validation, as they require statistical comparison using experimental and control groups conducting the same design task [164,198]. On the other hand, the methodology's usefulness for AM-Experts is not confirmed as no case study included a genuine AM expert as participating designer. This characteristic needs to be further investigated with the case study that includes AM experts or through the workshop with the AM experts. Nevertheless, the conducted case studies indicate these characteristics are achieved, but there is insufficient evidence to verify these claims.

The first not fulfilled characteristic is the lack of restrictive information regarding AM. This is not a significant drawback, more so as the inclusion of such information could influence the designer's creativity. However, if needed, such information could be added relatively easily. The second lacking characteristic is the multiple formats of representing AM DPs. As shown in case study four, the novice designers had some trouble comprehending AM capabilities, and additional modalities of representation could solve this problem [42]. This characteristic could be easily added to the mapping methodology and is planned for future research. On the other hand, while the evidence showed the mapping methodology is applicable for part design, designers had issues with using it for assembly design. This issue in using the methodology for the assembly design requires additional investigation to fully understand the problem and find a solution that will address it.

Based on these observations, it can be said that Mapping Methodology largely satisfies the criteria for early phase DfAM design support as defined by literature sources and is a valuable addition to the growing area of DfAM.

| 8.6 Validity of the Mapping Methodology

The final part of the discussion is the reflection on the validity of the research and its results. The validation process refers to the justification of knowledge claims [199], and it aims to respond to the question, "Did you do the right research?" [180]. While there exist several approaches to validation in research [179], this thesis adopts the approach of validating the research problem independently from the method used to address it [180]. To achieve the stated, the validation square is applied to demonstrate the usefulness of the design methodology proposed in this thesis [199,200]. The Mapping Methodology is validated through four phases of the validation square, as shown in Figure 8.3. Here the usefulness of the developed design methodology is addressed with respect to its purpose by referring to its efficiency and effectiveness.

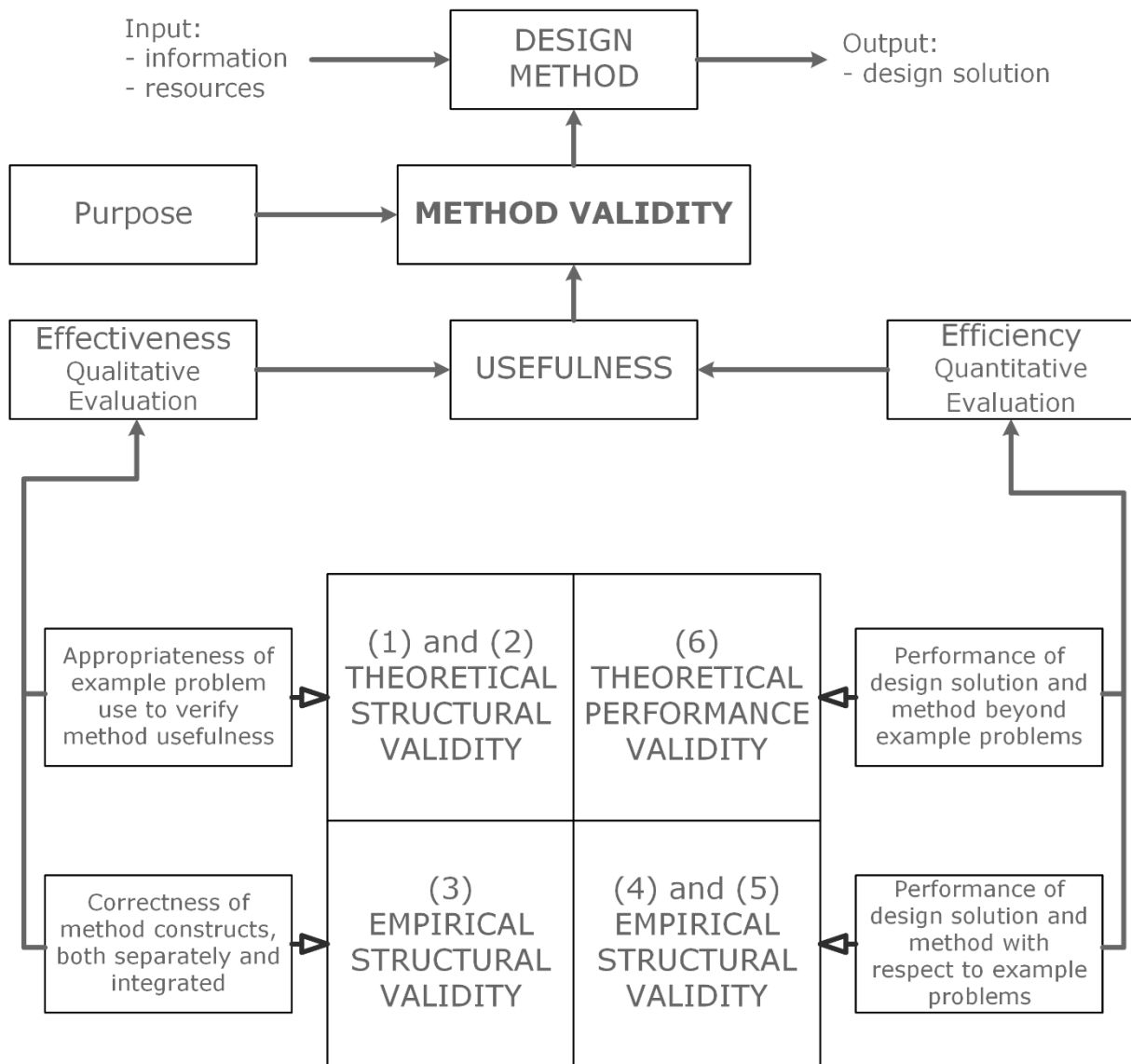

Figure 8.3 Validation Square [199,200]

Theoretical structural validity

For the design method to be effective, it must have theoretical structural validity achieved through (1) construct validity and (2) internal consistency [199,200]. The construct validity (1) is accepted through confidence in individual constructs constituting the methodology. The mapping methodology has two key well-known and well-established constructs in design research: the function structures and the DPs. Function structures are a long-standing tool used in the systematic design processes to describe a product's or system's functionality [18,28,31]. Over the years, the vocabulary used in the function structures [18,118,120,126], as well as rules for their creation [128,129,166] have been developed, and the mapping methodology is built on this existing body of knowledge. Similarly, the DPs as a form of storing design knowledge has been used in design science for a long time [18,28,49], and in recent years it has been adopted for storing AMK as well [39,40,48,103]. Internal consistency (2) is accepted by constructing

the flow chart of information flow to show the way methodology's constructs work. The information flow shown in Figure 8.4 demonstrates that the information flow is consistent and that output from one construct is an adequate input to another.

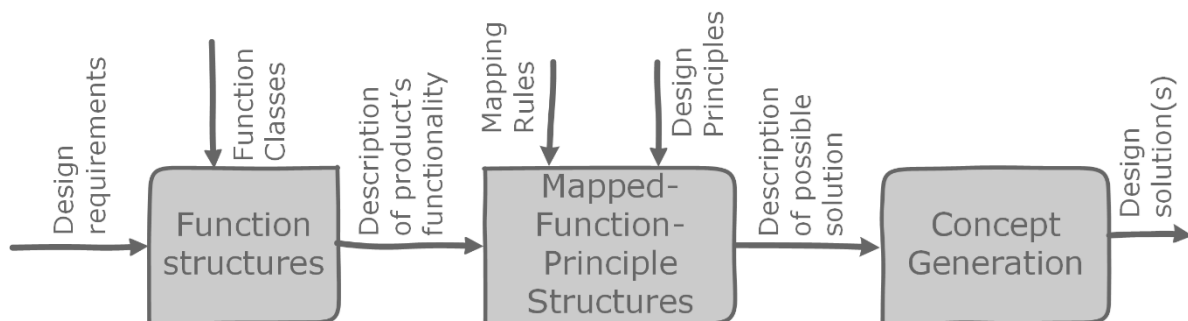

Figure 8.4 Construct's information flow

Empirical structural validity

The third part of the design method's effectiveness is the appropriateness of the example problems (3) reflected in the empirical structural validity [199,200]. The appropriateness of the example problems is built through confidence that examples used to validate the proposed mapping methodology are similar to the problems for which the individual constructs are accepted and that examples are representative examples of the problems the methodology is addressing. The design problems used in all four case studies used both function structure and DPs as methodology's constructs that are generally accepted. Furthermore, the case studies combined part and assembly design, new design and redesign tasks, individual tasks, and team tasks. As all these problems occur in the product design and development process, it can be stated that the used case studies are representative examples of the problems the methodology is addressing.

Empirical performance validity

The efficiency of the design method is assessed through (4) usefulness for some examples problems and (5) that the usefulness is linked to applying the design method [199,200]. The empirical performance of the mapping methodology is assessed for both usefulness and that the usefulness is linked to the methodology through a qualitative approach using a case study research method. The results of the case studies suggest the mapping methodology is useful for the design of AM components in both new design and redesign tasks. While there was no quantitative evaluation of the mapping methodology because the objectivity of case study research derives from the study of cases without direct influence on the design process, its performance or execution [180], this provides confidence for the mapping methodology's usefulness.

Theoretical performance validity

The final part of assessing the efficiency of the design method is to accept the usefulness of the method beyond the example problems (6) by building confidence in the generality of the method [199,200]. When the method is useful in a general sense, it can be considered theoretically performance valid.

As the case studies used for the assessment of empirical performance validity and usefulness of the mapping methodology were limited in the scope of the design problems assessed, the full generalisation of the Mapping Methodology cannot be made. Thus, the Mapping Methodology cannot be considered theoretically performance valid. However, as the selection of cases was based on the five different dimensions, and cases cover a large scope of these dimensions (Section 6.3), an intuitive argument is that the Mapping Methodology is useful for a more general class of problems [200]. This observation corresponds to “a Leap of Faith” [199,200] and thus the Mapping Methodology can be considered useful for a problem with similar characteristics.

Chapter 9 is the final chapter of the thesis. The chapter summarises the key points of the conducted research and reflects on the hypothesis of the research and expected contributions stated in the introductory chapter. Furthermore, this chapter discusses the research limitation and provides suggestions for further research related to the developed Mapping Methodology and DfAM for early design phases.

9.1 Research Outline

The presented thesis addresses the growing need for design support methods and tools tailored for designing AM products that will enable the utilisation of unique AM possibilities to satisfy user needs and improve products' performances. Hence, the objective of the research was to develop a methodology that will enable designers to find AM based solutions through mapping of product functions and AM DPs (Design Principles). To achieve the stated, the methodology has to enable function modelling of a product, provide a comprehensive source of AMK, and enable mapping of relations between product functions and form. The conducted research followed a DRM methodology as a Type 5 research project - *Development of Support Based on a Comprehensive Study of the Existing Situation* [55]. The methodology was based on four phases, Research Clarification (RC), Descriptive Study I (DS-I), Prescriptive Study (PS), and Descriptive Study II (DS-II).

The research started with RC through a comprehensive overview of the current literature on DfAM and function modelling (Chapter 2). The literature review identified four research gaps addressed through four RQ that guided the research. The first RQ investigates how the AM product's functionality should be represented through function structures. The second RQ addressed the problematics of what AMK is and how it should be stored and represented. The third RQ explores the relations between the functions and forms in AM products. The final RQ relates to the application of design methodology to enable function integration and embodiment of AM design solutions.

The RQs were addressed through the theoretical background established with the literature review (Chapter 2) and conducted the empirical study (Chapter 3). These activities relate to the DS-I phase of the research methodology. The theoretical background enabled a comprehensive overview of the existing body of knowledge on which the proposed mapping methodology was

9. Conclusion

built. At the same time, the empirical study enabled a thorough investigation of the phenomena through observation of the existing situation. The empirical study was conducted through inductive research, where for the pool AM products, their functionalities, forms, and the relations between the two were analysed.

The theoretical background and empirical results were used in the PS to develop the Mapping Methodology (Chapter 4). The Mapping Methodology prescribes the design process for early design phases that enable function modelling of a product, mapping of the product function structure to find AM solutions, and embodiment of the design solutions through concept generation. It is made of the FC (Function Class) method and mapping method. The FC method supports the function modelling process and enables the expression of products' functionality through function structures in a formal and repeatable manner. The mapping method uses MRs (Mapping Rules) to find possible AM solutions for a block of functions or individual functions of the product and map them with AM DPs. This creates one or more MFP (Mapped-Function-Principles) Structures used as input for concept generation. The theoretical framework of the Mapping Methodology is supported by the computational prototype framework (FM App) that supports the activities of function modelling and mapping (Chapter 5).

The DS-II phase of the research was made of two parts: validation of the Mapping Methodology through case study research (Chapter 6 and Chapter 7) and the discussion of the research and research results (Chapter 8). The validation included four cases where the Mapping Methodology was used to conduct activities in the early design phases of the AM oriented design process. This included the function modelling of products, search for AM based solutions, and generation of concepts. The case studies enabled qualitative validation of the proposed methodology needed for the validation of the research hypothesis. The results of the validation support the hypothesis of the conducted research. Finally, the discussion reflected on the answers to the four RQs, characteristics of the Mapping Methodology and the validity of the conducted research.

| 9.2 Hypothesis & Contribution

The main objective of the research was to develop a methodology for choosing AM DPs that will be used as a solution for one or more functions of a product and will help designers in the early phases of the DfAM process to utilise and implement unique possibilities of AM in their designs. It was hypothesised that:

Mapping of functional model of a product with design principles for additive manufacturing in early phases of design process enables function integration and embodiment of design solutions adapted for additive manufacturing.

The results reported in Chapter 7, as well as answers and discussion for four RQs reported in Chapter 8 support the stated hypothesis. Using the developed mapping methodology, designers participating in the case studies created designs that embodied solutions characteristic for AM and solved multiple functions using integrated solutions.

As stated in Section 1.4, the goal of the research was to contribute to the theoretical knowledge of design science and to provide practical design support for design engineers working on the conceptual design of new AM products. This is achieved through two scientific contributions of the thesis:

- *Methodology for early phases of product development process that will enable mapping of product functions or sequence of functions with design principles for additive manufacturing.*

The developed Mapping Methodology prescribes the activities for the early design phases of AM oriented design process and provides the necessary methods, tools, and sources of AMK to conduct those activities. It enables function modelling of products using FC method, provides MRs to conduct the mapping, and suggests AM DPs as a solution for product functions or sequence of functions.

- *Computational prototype framework for supporting mapping of functional model of a product with design principles for additive manufacturing based on proposed methodology with the goal of function integration and embodiment of design solution adapted for additive manufacturing.*

The computational prototype framework is embodied in the form of the FM App. The FM App provides computational support for functional modelling and mapping

activities prescribed in the mapping methodology. Furthermore, it stores the FCs, MRs and DPs and enables their review and utilisation.

| 9.3 Research Limitations

The research limitations can be summarised into three points: limitations of the data analysis, limitation of the Mapping Methodology for the design of assemblies, and limitations of the validation process.

The limitation of data analysis refers to the quantity and quality of data analysed in the empirical study. Firstly, due to established criteria for forming the pool of products that were analysed, not all found products were included in the analysis. Furthermore, the products analysed do not cover all domains of the AM application and the domains of AM included are not equally represented. Nevertheless, the diversity of products included in the analysis and the methodological approach of the research provides confidence for the generalisation of the Mapping Methodology for use in mechanical engineering and consumer product design domains. The second data limitation is the sample size of analysed products. While the data analysis was stopped after the number FCs, MRs and DPs derived converged to asymptotic value [49] (Section 3.6), additional data analysis will probably derive a few more instances.

The second research limitation is related to the design of assemblies. During the development of the Mapping Methodology, there was no particular focus on either part or assembly design. However, the validation process exposed the limitation of the methodology for the assembly design. It was unclear why this limitation occurred, although it could be related to the data limitation and selection of cases. Therefore, this limitation requires further investigation of the phenomena and addressing the limitation.

The final limitation is the validation process. Due to the scope and time frame of the thesis, validation only included the qualitative validation process. The validation was based on the four case studies that provided a good overview across the five dimensions observed. However, only one case study was from an industrial context, and further investigation of the Mapping Methodology in the design practice is needed. Furthermore, the lack of quantitative validation limited the investigation of how the Mapping Methodology influences the quality, quantity, variety, and novelty of generated designs [164], which needs to be addressed in the future.

| 9.4 Future Work

While future work must address the research limitations outlined in previous sections, there are also three prominent directions for future research and the extension of the developed mapping methodology.

Firstly, during the development of the FC method, the existence of patterns in how FCs are placed in the function structures was noted. By investigating these patterns, the FC method could be improved by extending the set of modelling rules to provide an additional level of syntax consistency. Furthermore, the formalisation of the observed patterns could be used to develop a semi-automated or even fully automated function modelling framework. Finally, the investigation of relations between patterns of functions and forms could be used to improve the effectiveness and efficiencies of the Mapping Methodology.

The second prominent direction for future research is the investigation and development of different modalities of AM DPs and mapping representation. Case study three identified the issue of how the AM DPs are perceived by inexperienced designers unfamiliar with the AM. Different possible modalities could be used for the representation of AM DPs [42]. By investigating their influence on the education of designers and the designer's creativity, overall improvements to Mapping Methodology and DfAM could be made.

Finally, the formalisation of the design knowledge through FCs, MRs, and AM DPs, could be used as a base for machine learning and artificial intelligence research. The study of these topics could result in the development of computational design methods and tools that will help designers in their everyday design activities and help them explore the AM enabled design space to create new products with improved functionalities and performance.

REFERENCES

- [1] Gibson I, Rosen D, Stucker B. *Additive Manufacturing Technologies*. New York, NY: Springer New York; 2015. doi. 10.1007/978-1-4939-2113-3.
- [2] Seepersad CC. Challenges and Opportunities in Design for Additive Manufacturing. *3D Printing and Additive Manufacturing*. 2014;1(1):10–3. doi. 10.1089/3dp.2013.0006.
- [3] Diegel O, Nordin A, Motte D. *A Practical Guide to Design for Additive Manufacturing*. Singapore: Springer Singapore; 2019. (Springer Series in Advanced Manufacturing). doi. 10.1007/978-981-13-8281-9.
- [4] Thompson MK, Moroni G, Vaneker T, Fadel G, Campbell RI, Gibson I, et al. Design for Additive Manufacturing: Trends, opportunities, considerations, and constraints. *CIRP Annals*. 2016;65(2):737–60. doi. 10.1016/j.cirp.2016.05.004.
- [5] Gao W, Zhang Y, Ramanujan D, Ramani K, Chen Y, Williams CB, et al. The status, challenges, and future of additive manufacturing in engineering. *Computer-Aided Design*. 2015;69:65–89. doi. 10.1016/j.cad.2015.04.001.
- [6] Bourell DL, Beaman Jr. JJ, Leu MC, Rosen DW. A Brief History of Additive Manufacturing and the 2009 Roadmap for Additive Manufacturing: Looking Back and Looking Ahead. In: *US – TURKEY Workshop On Rapid Technologies, September 24 – 24, 2009*. 2009. p. 5–11.
- [7] Campbell I, Diegel O, Kowen J, Wohlers T. *Wohlers report 2018: 3D printing and additive manufacturing state of the industry: annual worldwide progress report*. Wohlers Associates; 2018.
- [8] Sohi P. The future is Additive Manufacturing – if we take a more holistic view of the design opportunities. *Metal AM Vol. 7 No. 2*. 2021;
- [9] Pradel P, Zhu Z, Bibb R, Moultrie J. Investigation of design for additive manufacturing in professional design practice. *Journal of Engineering Design*. 2018;29(4–5):165–200. doi. 10.1080/09544828.2018.1454589.
- [10] Pradel P, Zhu Z, Bibb R, Moultrie J. A framework for mapping design for additive manufacturing knowledge for industrial and product design. *Journal of Engineering Design*. 2018;29(6):291–326. doi. 10.1080/09544828.2018.1483011.
- [11] Eckert CM, Stacey M, Earl C. References to past designs. In: *Studying designers*. 2005. p. 3–21.

- [12] Linsey JS, Tseng I, Fu K, Cagan J, Wood KL, Schunn C. A Study of Design Fixation, Its Mitigation and Perception in Engineering Design Faculty. *Journal of Mechanical Design*. 2010;132(4). doi. 10.1115/1.4001110.
- [13] Gonçalves M, Cardoso C, Badke-Schaub P. What inspires designers? Preferences on inspirational approaches during idea generation. *Design Studies*. 2014;35(1):29–53. doi. 10.1016/j.destud.2013.09.001.
- [14] Klein Blösch A. *Design Heuristics for Additive Manufacturing*. 2020.
- [15] Laverne F, Segonds F, Anwer N, le Coq M. Assembly Based Methods to Support Product Innovation in Design for Additive Manufacturing: An Exploratory Case Study. *Journal of Mechanical Design*. 2015;137(12):121701. doi. 10.1115/1.4031589.
- [16] Yang S, Tang Y, Zhao YF. Assembly-Level Design for Additive Manufacturing: Issues and Benchmark. In: Volume 2A: 42nd Design Automation Conference. American Society of Mechanical Engineers; 2016. p. V02AT03A028. doi. 10.1115/DETC2016-59565.
- [17] Bralla JG. *Design for Excellence*. McGraw-Hill; 1996.
- [18] Pahl G, Beitz W, Feldhusen J, Grote K-H. *Engineering Design*. London: Springer London; 2007. doi. 10.1007/978-1-84628-319-2.
- [19] Vaneker T, Bernard A, Moroni G, Gibson I, Zhang Y. Design for additive manufacturing: Framework and methodology. *CIRP Annals*. 2020;69(2):578–99. doi. 10.1016/j.cirp.2020.05.006.
- [20] Seepersad CC, Govett T, Kim K, Lundin M, Pinero D. A designer's guide for dimensioning and tolerancing SLS parts. In: 23rd Annual International Solid Freeform Fabrication Symposium - An Additive Manufacturing Conference, SFF 2012; Austin, TX; United States; 6-8 August 2012. 2012. p. 921–31.
- [21] Bikas H, Lianos AK, Stavropoulos P. A design framework for additive manufacturing. *The International Journal of Advanced Manufacturing Technology*. 2019;103(9–12):3769–83. doi. 10.1007/s00170-019-03627-z.
- [22] Tang Y, Zhao YF. A survey of the design methods for additive manufacturing to improve functional performance. *Rapid Prototyping Journal*. 2016;22(3):569–90. doi. 10.1108/RPJ-01-2015-0011.
- [23] Lockett H, Ding J, Williams S, Martina F. Design for Wire + Arc Additive Manufacture: design rules and build orientation selection. *Journal of Engineering Design*. 2017;28(7–9):568–98. doi. 10.1080/09544828.2017.1365826.

References

- [24] Ameta G, Lipman R, Moylan S, Witherell P. Investigating the Role of Geometric Dimensioning and Tolerancing in Additive Manufacturing. *Journal of Mechanical Design*. 2015;137(11). doi. 10.1115/1.4031296.
- [25] Das P, Chandran R, Samant R, Anand S. Optimum Part Build Orientation in Additive Manufacturing for Minimizing Part Errors and Support Structures. *Procedia Manufacturing*. 2015;1:343–54. doi. 10.1016/j.promfg.2015.09.041.
- [26] Meisel N, Williams C. An Investigation of Key Design for Additive Manufacturing Constraints in Multimaterial Three-Dimensional Printing. *Journal of Mechanical Design*. 2015;137(11). doi. 10.1115/1.4030991.
- [27] Lei N, Yao X, Moon SK, Bi G. An additive manufacturing process model for product family design. *Journal of Engineering Design*. 2016;27(11):751–67. doi. 10.1080/09544828.2016.1228101.
- [28] Otto KN, Wood KL. *Product Design: Techniques in Reverse Engineering and New Product Development*. Prentice Hall; 2001.
- [29] Ullman DG. *The Mechanical Design Process*. Fourth Edi. New York: McGraw-Hill; 2010.
- [30] Hubka V, Eder WE. *Theory of Technical Systems*. Berlin, Heidelberg: Springer Berlin Heidelberg; 1988. doi. 10.1007/978-3-642-52121-8.
- [31] Dym CL, Little P, Orwin EJ. *Engineering Design: A Project-Based Introduction*. Fourth Edi. Wiley; 2014.
- [32] Ulrich KD, Eppinger SD, Yang MC. *Product Design and Development*. 7th ed. McGraw-Hill Education; 2020.
- [33] Chakrabarti A, Blessing L. Special Issue: Representing functionality in design. *Artificial Intelligence for Engineering Design, Analysis and Manufacturing*. 1996;10(4):251–3. doi. 10.1017/S0890060400001608.
- [34] Zhang WY, Tor SB, Britton GA. A graph and matrix representation scheme for functional design of mechanical products. *The International Journal of Advanced Manufacturing Technology*. 2005;25(3–4):221–32. doi. 10.1007/s00170-003-1827-3.
- [35] Richter T, Inkermann D, Vietor T. A Framework for Integrated Product Architecture Design. In: *DS 85-1: Proceedings of NordDesign 2016, Volume 1, Trondheim, Norway, 10th - 12th August 2016*. Trondheim, Norway: The Design Society; 2016. p. 310–20.
- [36] Kalyanasundaram V, Lewis K. A Function Based Approach for Product Integration. In: *Volume 5: 37th Design Automation Conference, Parts A and B*. ASMEDC; 2011. p. 263–79. doi. 10.1115/DETC2011-47922.

- [37] Weiss F, Binz H, Roth D. Conception of a design catalogue for the development of functionalities with additive manufacturing. In: Boks C, Sigurjonsson J, Steinert M, Vis C, Wulvik A, editors. DS 85-2: Proceedings of NordDesign 2016, Volume 2, Trondheim, Norway, 10th - 12th August 2016. Trondheim: The Design Society; 2016. p. 002–11.
- [38] Boyard N, Rivette M, Christmann O, Richir S. A design methodology for parts using additive manufacturing. In: 6th International Conference on Advanced research in Virtual and rapid prototyping. 2013. p. 399–404.
- [39] Schumacher F, Watschke H, Kuschmitz S, Vietor T. Goal Oriented Provision of Design Principles for Additive Manufacturing to Support Conceptual Design. Proceedings of the Design Society: International Conference on Engineering Design. 2019;1(1):749–58. doi. 10.1017/dsi.2019.79.
- [40] Watschke H, Kuschmitz S, Heubach J, Lehne G, Vietor T. A Methodical Approach to Support Conceptual Design for Multi-Material Additive Manufacturing. Proceedings of the Design Society: International Conference on Engineering Design. 2019;1(1):659–68. doi. 10.1017/dsi.2019.70.
- [41] Valjak F, Bojčetić N, Lukić M. Design for Additive Manufacturing: Mapping of product functions. In: Marjanović D, Štorga M, Škec S, Bojčetić N, Pavković N, editors. DS 92: Proceedings of the DESIGN 2018 15th International Design Conference. Dubrovnik, Croatia: The Design Society; 2018. p. 1369–80. doi. 10.21278/idc.2018.0364.
- [42] Valjak F, Bojčetić N. Conception of Design Principles for Additive Manufacturing. Proceedings of the Design Society: International Conference on Engineering Design. 2019;1(1):689–98. doi. 10.1017/dsi.2019.73.
- [43] Ulrich KT, Seering WP. Function sharing in mechanical design. Design Studies. 1990;11(4):223–34. doi. 10.1016/0142-694X(90)90041-A.
- [44] Yang S, Tang Y, Zhao YF. A new part consolidation method to embrace the design freedom of additive manufacturing. Journal of Manufacturing Processes. 2015;20:444–9. doi. 10.1016/j.jmapro.2015.06.024.
- [45] Yang S, Zhao YF. Conceptual Design for Assembly in the Context of Additive Manufacturing. In: Solid Freeform Fabrication 2016: Proceedings of the 26th Annual International Solid Freeform Fabrication Symposium – An Additive Manufacturing Conference. 2016. p. 1932–44.
- [46] bin Maidin S, Campbell I, Pei E. Development of a design feature database to support design for additive manufacturing. Assembly Automation. 2012;32(3):235–44. doi. 10.1108/01445151211244375.

- [47] Blösch-Paidosh A, Shea K. Design heuristics for additive manufacturing. In: Maier A, Škec S, Kim H, Kokkolaras M, Oehmen J, Fadel G, et al., editors. DS 87-5 Proceedings of the 21st International Conference on Engineering Design (ICED 17) Vol 5: Design for X, Design to X, Vancouver, Canada, 21-25.08.2017. Vancouver, Canada: The Design Society; 2017. p. 091–100.
- [48] Perez KB, Anderson DS, Hölttä-Otto K, Wood KL. Crowdsourced design principles for leveraging the capabilities of additive manufacturing. In: Proceedings of the 20th International Conference on Engineering Design (ICED15). Milan, Italy: The Design Society; 2015. p. 1–10.
- [49] Fu KK, Yang MC, Wood KL. Design Principles: Literature Review, Analysis, and Future Directions. *Journal of Mechanical Design*. 2016;138(10). doi. 10.1115/1.4034105.
- [50] Valjak F, Lindwall A. Review of design heuristics and design principles in design for additive manufacturing. *Proceedings of the Design Society*. 2021;1:2571–80. doi. 10.1017/pds.2021.518.
- [51] Verma M, Wood WH. Form Follows Function: Case-Based Learning Over Product Evolution. In: Volume 3: 6th Design for Manufacturing Conference. American Society of Mechanical Engineers; 2001. p. 219–29. doi. 10.1115/DETC2001/DFM-21182.
- [52] Vermaas PE. The coexistence of engineering meanings of function: Four responses and their methodological implications. *Artificial Intelligence for Engineering Design, Analysis and Manufacturing*. 2013;27(3):191–202. doi. 10.1017/S0890060413000206.
- [53] Kurtoglu T, Campbell MI. Automated synthesis of electromechanical design configurations from empirical analysis of function to form mapping. *Journal of Engineering Design*. 2009;20(1):83–104. doi. 10.1080/09544820701546165.
- [54] Osserman R. mapping. *Britannica*. Available from: <https://www.britannica.com/science/mapping> [cited 2022 Mar 2];
- [55] Blessing LTM, Chakrabarti A. DRM, a Design Research Methodology. London: Springer London; 2009. doi. 10.1007/978-1-84882-587-1.
- [56] Lipson H, Kurman M. *Fabricated: The New World of 3D Printing*. Wiley; 2013.
- [57] International Organization for Standardization. ISO/ASTM 52900:2021(en) Additive manufacturing — General principles — Fundamentals and vocabulary. 2021.
- [58] Godec D, Šercer M. *Aditivna proizvodnja*. Zagreb: Fakultet strojarstva i brodogradnje; 2015.

- [59] Gebhardt A. *Understanding Additive Manufacturing*. München: Carl Hanser Verlag GmbH & Co. KG; 2011. doi. 10.3139/9783446431621.
- [60] Gräßler I, Taplick P, Pottebaum J, Scholle P, Reiher T. Data management for additive manufacturing: Survey on requirements and current state. In: DS 84: Proceedings of the DESIGN 2016 14th International Design Conference. Dubrovnik, Croatia: The Design Society; 2016. p. 211–20.
- [61] ISO/ASTM 52915:2020. Specification for additive manufacturing file format (AMF) Version 1.2. ISO; 2020.
- [62] 3MF Consortium. 3D Manufacturing Format Core Specification & Reference Guide Version 1.2.3. 2018.
- [63] Kim DB, Witherell P, Lipman R, Feng SC. Streamlining the additive manufacturing digital spectrum: A systems approach. *Additive Manufacturing*. 2015;5:20–30. doi. 10.1016/j.addma.2014.10.004.
- [64] Haipeng P, Tianrui Z. Generation and optimization of slice profile data in rapid prototyping and manufacturing. *Journal of Materials Processing Technology*. 2007;187–188:623–6. doi. 10.1016/j.jmatprotec.2006.11.221.
- [65] Gupta V, Bajpai V, Tandon P. Slice Generation and Data Retrieval Algorithm for Rapid Manufacturing of Heterogeneous Objects. *Computer-Aided Design and Applications*. 2014;11(3):255–62. doi. 10.1080/16864360.2014.863483.
- [66] 17296-2:2015 I. Additive manufacturing — General principles — Part 2: Overview of process categories and feedstock. ISO; 2015.
- [67] Vaezi M, Chianrabutra S, Mellor B, Yang S. Multiple material additive manufacturing – Part 1: a review. *Virtual and Physical Prototyping*. 2013;8(1):19–50. doi. 10.1080/17452759.2013.778175.
- [68] Karunakaran KP, Bernard A, Suryakumar S, Dembinski L, Taillandier G. Rapid manufacturing of metallic objects. *Rapid Prototyping Journal*. 2012;18(4):264–80. doi. 10.1108/13552541211231644.
- [69] Rosen DW. Computer-Aided Design for Additive Manufacturing of Cellular Structures. *Computer-Aided Design and Applications*. 2007;4(5):585–94. doi. 10.1080/16864360.2007.10738493.
- [70] Rosen DW. Design for Additive Manufacturing: A Method to Explore Unexplored Regions of the Design Space. In: 2007 International Solid Freeform Fabrication Symposium. 2007. doi. 10.26153/tsw/7227.

- [71] Rozvany GIN. A critical review of established methods of structural topology optimization. *Structural and Multidisciplinary Optimization*. 2009;37(3):217–37. doi. 10.1007/s00158-007-0217-0.
- [72] Hague R, Mansour S, Saleh N. Design opportunities with rapid manufacturing. *Assembly Automation*. 2003;23(4):346–56. doi. 10.1108/01445150310698643.
- [73] Järvinen J-P, Matilainen V, Li X, Piili H, Salminen A, Mäkelä I, et al. Characterization of Effect of Support Structures in Laser Additive Manufacturing of Stainless Steel. *Physics Procedia*. 2014;56:72–81. doi. 10.1016/j.phpro.2014.08.099.
- [74] Doubrovski Z, Verlinden JC, Horvath I. First steps towards collaboratively edited design for additive manufacturing knowledge. In: *Solid Freeform Fabrication Symposium*, Austin, TX: University of Texas at Austin (freeform). Austin, TX; 2012. p. 891–901.
- [75] Laverne F, Segonds F, Anwer N, le Coq M. DFAM in the design process: A proposal of classification to foster early design stages. In: *CONFERE 2014*. 2014. p. 1–12.
- [76] Yang S, Zhao YF. Additive manufacturing-enabled design theory and methodology: a critical review. *The International Journal of Advanced Manufacturing Technology*. 2015;80(1–4):327–42. doi. 10.1007/s00170-015-6994-5.
- [77] Kumke M, Watschke H, Vietor T. A new methodological framework for design for additive manufacturing. *Virtual and Physical Prototyping*. 2016;11(1):3–19. doi. 10.1080/17452759.2016.1139377.
- [78] Segonds F, Cohen G, Véron P, Peyceré J. PLM and early stages collaboration in interactive design, a case study in the glass industry. *International Journal on Interactive Design and Manufacturing (IJIDeM)*. 2016;10(2):95–104. doi. 10.1007/s12008-014-0217-4.
- [79] Renjith SC, Okudan Kremer GE, Park K. A Design Framework for Additive Manufacturing through the Synergistic Use of Axiomatic Design Theory and TRIZ. In: Barker K, Berry D, Rainwater C, editors. *Proceedings of the 2018 IISE Annual Conference*. May 19–22, 2018, Orlando, Florida. 2018. p. 1–7.
- [80] Segonds F. Design By Additive Manufacturing: an application in aeronautics and defence. *Virtual and Physical Prototyping*. 2018;13(4):237–45. doi. 10.1080/17452759.2018.1498660.
- [81] Rias A -I., Bouchard C, Segonds F, Abed S. Design for additive manufacturing: A creative approach. In: Dorian M, Mario S, Neven P, Nenad B, Stanko S, editors. *DS 84: Proceedings of the DESIGN 2016 14th International Design Conference*. Dubrovnik, Croatia: The Design Society; 2016. p. 411–20.

- [82] Rias A-L, Segonds F, Bouchard C, Abed S. Towards additive manufacturing of intermediate objects (AMIO) for concepts generation. *International Journal on Interactive Design and Manufacturing (IJIDeM)*. 2017;11(2):301–15. doi. 10.1007/s12008-017-0369-0.
- [83] Kaspar J, Stoffels P, Schneberger J-H, Vielhaber M. Integrated Product, Production and Material Definition for Conventional versus Generative Manufacturing Technologies. *Procedia CIRP*. 2018;70:180–5. doi. 10.1016/j.procir.2018.03.140.
- [84] uz Zaman UK, Rivette M, Siadat A, Baqai AA. Integrated design-oriented framework for Resource Selection in Additive Manufacturing. *Procedia CIRP*. 2018;70:96–101. doi. 10.1016/j.procir.2018.02.039.
- [85] Kumke M, Watschke H, Hartogh P, Bavendiek A-K, Vietor T. Methods and tools for identifying and leveraging additive manufacturing design potentials. *International Journal on Interactive Design and Manufacturing (IJIDeM)*. 2018;12(2):481–93. doi. 10.1007/s12008-017-0399-7.
- [86] Perez KB, Lauff CA, Camburn BA, Wood KL. Design Innovation With Additive Manufacturing: A Methodology. In: Volume 7: 31st International Conference on Design Theory and Methodology. American Society of Mechanical Engineers; 2019. doi. 10.1115/DETC2019-97400.
- [87] Perez B, Hilburn S, Jensen D, Wood KL. Design principle-based stimuli for improving creativity during ideation. *Proceedings of the Institution of Mechanical Engineers, Part C: Journal of Mechanical Engineering Science*. 2019;233(2):493–503. doi. 10.1177/0954406218809117.
- [88] Perez KB. Design innovation with additive manufacturing (am) : an am-centric design innovation process. 2018.
- [89] Gross J, Park K, Kremer GEO. Design for Additive Manufacturing Inspired by TRIZ. In: Volume 4: 23rd Design for Manufacturing and the Life Cycle Conference; 12th International Conference on Micro- and Nanosystems. American Society of Mechanical Engineers; 2018. p. V004T05A004. doi. 10.1115/DETC2018-85761.
- [90] Leutenecker-Twelsiek B, Klahn C, Meboldt M. Considering Part Orientation in Design for Additive Manufacturing. *Procedia CIRP*. 2016;50:408–13. doi. 10.1016/j.procir.2016.05.016.
- [91] Borgue O, Jakob M, Massimo P, Isaksson O. Function modelling and constraints replacement to support design for additive manufacturing of satellite components. In: Ekströmer P, Schütte S, Ölvander J, editors. DS 91: Proceedings of NordDesign 2018,

- Linköping, Sweden, 14th - 17th August 2018. Linköping: The Design Society; 2018. p. 1–10.
- [92] Johannesson H, Claesson A. Systematic product platform design: a combined function-means and parametric modeling approach. *Journal of Engineering Design*. 2005;16(1):25–43. doi. 10.1080/09544820512331325247.
- [93] Yang S, Zhao YF. Conceptual design for assembly in the context of additive manufacturing. In: *Solid Freeform Fabrication 2016: Proceedings of the 26th Annual International Solid Freeform Fabrication Symposium – An Additive Manufacturing Conference*. Austin, USA: University of Texas at Austin; 2016. p. 1932–44.
- [94] Markou F, Segonds F, Rio M, Perry N. A methodological proposal to link Design with Additive Manufacturing to environmental considerations in the Early Design Stages. *International Journal on Interactive Design and Manufacturing (IJIDeM)*. 2017;11(4):799–812. doi. 10.1007/s12008-017-0412-1.
- [95] Gerber GF, Barnard LJ. Designing for laser sintering. *Journal for New Generation Sciences*. 2008;6(2).
- [96] Gibson I, Goenka G, Narasimhan R, Bhat N. Design rules for additive manufacture. In: *Proceedings of the Solid Freeform Fabrication 2010 international symposium*. Austin, Texas; 2010. p. 705–16.
- [97] Adam GAO, Zimmer D. Design for Additive Manufacturing—Element transitions and aggregated structures. *CIRP Journal of Manufacturing Science and Technology*. 2014;7(1):20–8. doi. 10.1016/j.cirpj.2013.10.001.
- [98] bin Maidin S. Development of a design feature database to support design for additive manufacturing (DfAM). 2011.
- [99] Blösch-Paidosh A, Shea K. Design Heuristics for Additive Manufacturing Validated Through a User Study. *Journal of Mechanical Design*. 2019;141(4):041101. doi. 10.1115/1.4041051.
- [100] Lindwall A, Törlind P. Evaluating design heuristics for additive manufacturing as an explorative workshop method. In: Marjanović D, Štorga M, Škec S, Bojčetić N, Pavković N, editors. *DS 92: Proceedings of the DESIGN 2018 15th International Design Conference*. Dubrovnik, Croatia: The Design Society; 2018. p. 1221–32. doi. 10.21278/idc.2018.0310.
- [101] Roth K. *Konstruieren mit Konstruktionskatalogen*. Berlin, Heidelberg: Springer Berlin Heidelberg; 2001. doi. 10.1007/978-3-642-17467-4.

- [102] Watschke H, Bavendiek A-K, Giannakos A, Vietor T. A methodical approach to support ideation for additive manufacturing in design education. In: Maier A, Škec S, Kim H, Kokkolaras M, Oehmen J, Fadel G, et al., editors. DS 87-5 Proceedings of the 21st International Conference on Engineering Design (ICED 17) Vol 5: Design for X, Design to X, Vancouver, Canada, 21-25.08.2017. The Design Society; 2017. p. 41–50.
- [103] Hwang D, Blake Perez K, Anderson D, Jensen D, Camburn B, Wood K. Design Principles for Additive Manufacturing: Leveraging Crowdsourced Design Repositories. *Journal of Mechanical Design*. 2021;143(7). doi. 10.1115/1.4050873.
- [104] Lauff CA, Perez KB, Camburn BA, Wood KL. Design Principle Cards: Toolset to Support Innovations With Additive Manufacturing. In: Volume 4: 24th Design for Manufacturing and the Life Cycle Conference; 13th International Conference on Micro- and Nanosystems. American Society of Mechanical Engineers; 2019. doi. 10.1115/DETC2019-97231.
- [105] Blösch-Paidosh A. Design Heuristics for Additive Manufacturing. 2019. Available from: <https://edac.ethz.ch/Research/Design-Heuristics-AM.html>
- [106] Blösch-Paidosh A, Ahmed-Kristensen S, Shea K. Evaluating the Potential of Design for Additive Manufacturing Heuristic Cards to Stimulate Novel Product Redesigns. In: Volume 2A: 45th Design Automation Conference. American Society of Mechanical Engineers; 2019. doi. 10.1115/DETC2019-97865.
- [107] Weiss F, Binz H, Roth D. Approach To Consider Rapid Manufacturing in the Early Phases of Product Development. In: Weber C, Husung S, Cantamessa M, Cascini G, Marjanović D, Graziosi S, editors. DS 80-4 Proceedings of the 20th International Conference on Engineering Design (ICED 15) Vol 4: Design for X, Design to X, Milan, Italy, 27-30.07.15. Milan, Italy: The Design Society; 2015. p. 001–10.
- [108] Booth JW, Alperovich J, Chawla P, Ma J, Reid TN, Ramani K. The Design for Additive Manufacturing Worksheet. *Journal of Mechanical Design*. 2017;139(10):100904 (9 pages). doi. 10.1115/1.4037251.
- [109] Stone RB, Wood KL. Development of a Functional Basis for Design. *Journal of Mechanical Design*. 2000;122(4):359–70. doi. 10.1115/1.1289637.
- [110] Caldwell BW, Sen C, Mocko GM, Summers JD, Fadel GM. Empirical Examination of the Functional Basis and Design Repository. In: Design Computing and Cognition '08. Dordrecht: Springer Netherlands; 2008. p. 261–80. doi. 10.1007/978-1-4020-8728-8_14.

- [111] Deng Y-M, Britton GA, Tor SB. A design perspective of mechanical function and its object-oriented representation scheme. *Engineering with Computers*. 1998;14(4):309–20. doi. 10.1007/BF01201762.
- [112] Nagel RL, Vucovich JP, Stone RB, McAdams DA. A Signal Grammar to Guide Functional Modeling of Electromechanical Products. *Journal of Mechanical Design*. 2008;130(5). doi. 10.1115/1.2885185.
- [113] Bohm MR, Stone RB. Representing Functionality to Support Reuse: Conceptual and Supporting Functions. In: Volume 4: 24th Computers and Information in Engineering Conference. ASMEDC; 2004. p. 411–9. doi. 10.1115/DETC2004-57693.
- [114] Erden MS, Komoto H, van Beek TJ, D'Amelio V, Echavarria E, Tomiyama T. A review of function modeling: Approaches and applications. *Artificial Intelligence for Engineering Design, Analysis and Manufacturing*. 2008;22(2):147–69. doi. 10.1017/S0890060408000103.
- [115] Hubka V, Eder WE. Functions Revisited. In: International Conference On Engineering Design ICED OI Glasgow, August 21–23, 2001. Glasgow: WDK Publication; 2001. p. 69–76.
- [116] Sen C. A formal representation of mechanical functions to support physics-based computational reasoning in early mechanical design. Clemson University; 2011.
- [117] Eckert C, Alink T, Ruckpaul A, Albers A. Different notions of function: results from an experiment on the analysis of an existing product. *Journal of Engineering Design*. 2011;22(11–12):811–37. doi. 10.1080/09544828.2011.603297.
- [118] Hirtz J, Stone RB, McAdams DA, Szykman S, Wood KL. A functional basis for engineering design: Reconciling and evolving previous efforts. *Research in Engineering Design*. 2002;13(2):65–82. doi. 10.1007/s00163-001-0008-3.
- [119] Collins JA, Hagan BT, Bratt HM. The Failure-Experience Matrix—A Useful Design Tool. *Journal of Engineering for Industry*. 1976;98(3):1074–9. doi. 10.1115/1.3439009.
- [120] Hundal MS. A Systematic method for developing function structures, solutions and concept variants. *Mechanism and Machine Theory*. 1990;25(3):243–56. doi. 10.1016/0094-114X(90)90027-H.
- [121] Little AD, Wood KL. Functional Analysis: A Fundamental Empirical Study for Reverse Engineering, Benchmarking, and Redesign. In: ASME DTM Conference. 1997. p. 1–21.
- [122] Szykman S, Racz JW, Sriram RD. The Representation of Function in Computer-Based Design. In: Volume 3: 11th International Conference on Design Theory and

- Methodology. American Society of Mechanical Engineers; 1999. p. 233–46. doi. 10.1115/DETC99/DTM-8742.
- [123] Lucero B, Viswanathan VK, Linsey JS, Turner CJ. Identifying Critical Functions for Use Across Engineering Design Domains. *Journal of Mechanical Design*. 2014;136(12). doi. 10.1115/1.4028280.
- [124] Kurfman MA, Stock ME, Stone RB, Rajan J, Wood KL. Experimental Studies Assessing the Repeatability of a Functional Modeling Derivation Method. *Journal of Mechanical Design*. 2003;125(4):682–93. doi. 10.1115/1.1625400.
- [125] Ahmed S, Wallace K. Evaluating a Functional Basis. In: Volume 3b: 15th International Conference on Design Theory and Methodology. ASMEDC; 2003. p. 901–7. doi. 10.1115/DETC2003/DTM-48685.
- [126] Caldwell BW, Sen C, Mocko GM, Summers JD. An empirical study of the expressiveness of the functional basis. *Artificial Intelligence for Engineering Design, Analysis and Manufacturing*. 2011;25(3):273–87. doi. 10.1017/S0890060410000442.
- [127] Sridharan P, Campbell MI. A study on the grammatical construction of function structures. *Artificial Intelligence for Engineering Design, Analysis and Manufacturing*. 2005;19(3):139–60. doi. 10.1017/S0890060405050110.
- [128] Bohm MR, Stone RB. Form Follows Form: Fine Tuning Artificial Intelligence Methods. In: Volume 3: 30th Computers and Information in Engineering Conference, Parts A and B. ASMEDC; 2010. p. 519–28. doi. 10.1115/DETC2010-28774.
- [129] Sen C, Summers JD, Mocko GM. A Formal Representation of Function Structure Graphs for Physics-Based Reasoning. *Journal of Computing and Information Science in Engineering*. 2013;13(2). doi. 10.1115/1.4023167.
- [130] Sen C, Summers JD, Mocko GM. Physics-Based Reasoning in Conceptual Design Using a Formal Representation of Function Structure Graphs. *Journal of Computing and Information Science in Engineering*. 2013;13(1). doi. 10.1115/1.4023488.
- [131] Mohammed OM, Shammari AZM. A Procedural Algorithmic Approach for Functional Structure Construction. *Engineering, Technology & Applied Science Research*. 2021;11(1):6819–32. doi. 10.48084/etasr.4012.
- [132] Nagel RL, Bohm MR, Stone RB, McAdams DA. A representation of carrier flows for functional design. In: DS 42: Proceedings of ICED 2007, the 16th International Conference on Engineering Design, Paris, France, 28.-31.07. 2007. The Design Society; 2007. p. 413–21.

- [133] Bohm MR, Nagel RL. Formalizing Flow Relationships in Data Archival and Reuse for Product Design. In: Volume 2: 31st Computers and Information in Engineering Conference, Parts A and B. ASMEDC; 2011. p. 1197–209. doi. 10.1115/DETC2011-47849.
- [134] Wang K-L, Jin Y. An Analytical Approach to Functional Design. In: Volume 2: 28th Design Automation Conference. ASMEDC; 2002. p. 449–59. doi. 10.1115/DETC2002/DAC-34084.
- [135] Ulrich K, Eppinger S. Product Design and Development. 4th Editio. New York: McGraw-Hill Education; 2007.
- [136] Gershenson JK, Prasad GJ, Zhang Y. Product modularity: Definitions and benefits. *Journal of Engineering Design*. 2003;14(3):295–313. doi. 10.1080/0954482031000091068.
- [137] Roy U, Pramanik N, Sudarsan R, Sriram RD, Lyons KW. Function-to-form mapping: model, representation and applications in design synthesis. *Computer-Aided Design*. 2001;33(10):699–719. doi. 10.1016/S0010-4485(00)00100-7.
- [138] Glasschroeder J, Prager E, Zaeh MF. Powder-bed-based 3D-printing of function integrated parts. *Rapid Prototyping Journal*. 2015;21(2):207–15. doi. 10.1108/RPJ-12-2014-0172.
- [139] Sossou G, Demoly F, Montavon G, Gomes S. An additive manufacturing oriented design approach to mechanical assemblies. *Journal of Computational Design and Engineering*. 2018;5(1):3–18. doi. 10.1016/j.jcde.2017.11.005.
- [140] Rodrigue H, Rivette M. An Assembly-Level Design for Additive Manufacturing Methodology. In: Proceedings of IDMME - Virtual Concept 2010. Bordeaux, France; 2010.
- [141] Strawbridge Z, McAdams DA, Stone RB. A Computational Approach to Conceptual Design. In: Volume 4: 14th International Conference on Design Theory and Methodology, Integrated Systems Design, and Engineering Design and Culture. ASMEDC; 2002. p. 15–25. doi. 10.1115/DETC2002/DTM-34001.
- [142] Bryant CR, Stone RB, McAdams DA, Kurtoglu T, Campbell MI. Concept generation from the functional basis of design. In: DS 35: Proceedings ICED 05, the 15th International Conference on Engineering Design, Melbourne, Australia, 15.-18.08. 2005. 2005.

- [143] Kota S, Chiou S-J. Conceptual design of mechanisms based on computational synthesis and simulation of kinematic building blocks. *Research in Engineering Design*. 1992;4(2):75–87. doi. 10.1007/BF01580146.
- [144] Nix AA, Sherrett B, Stone RB. A Function Based Approach to TRIZ. In: Volume 9: 23rd International Conference on Design Theory and Methodology; 16th Design for Manufacturing and the Life Cycle Conference. ASMEDC; 2011. p. 285–95. doi. 10.1115/DETC2011-47973.
- [145] Altshuller GS. *Creativity As an Exact Science*. Gordon and Breach Publishers; 1984.
- [146] Kurtoglu T, Campbell MI. An evaluation scheme for assessing the worth of automatically generated design alternatives. *Research in Engineering Design*. 2009;20(1):59–76. doi. 10.1007/s00163-008-0062-1.
- [147] Chen J-W, Yang H-J, Cui J-J, Zhang J-S. Concept semantics driven computer aided product innovation design. *Journal of Computational Methods in Sciences and Engineering*. 2016;16(3):575–90. doi. 10.3233/JCM-160641.
- [148] Tang D, Kang Y, Zhu R. Functional reverse design for secondary innovation. *International Journal of Product Lifecycle Management*. 2011;5(2/3/4):183. doi. 10.1504/IJPLM.2011.043187.
- [149] Zhang M, Li G-X, Gong J-Z, Wu B-Z. A hierarchical functional solving framework with hybrid mappings for supporting the design process in the conceptual phase. *Proceedings of the Institution of Mechanical Engineers, Part B: Journal of Engineering Manufacture*. 2012;226(8):1401–15. doi. 10.1177/0954405412450379.
- [150] Tumer IY, Stone RB. Mapping function to failure mode during component development. *Research in Engineering Design*. 2003;14(1):25–33. doi. 10.1007/s00163-002-0024-y.
- [151] Grantham Lough K, Stone R, Tumer IY. Function Based Risk Assessment: Mapping Function to Likelihood. In: Volume 5a: 17th International Conference on Design Theory and Methodology. ASMEDC; 2005. p. 455–67. doi. 10.1115/DETC2005-85053.
- [152] McAdams DA, Wood KL. Quantitative Measures for Design by Analogy. In: Volume 4: 12th International Conference on Design Theory and Methodology. American Society of Mechanical Engineers; 2000. p. 191–201. doi. 10.1115/DETC2000/DTM-14562.
- [153] McAdams DA, Stone RB, Wood KL. Functional Interdependence and Product Similarity Based on Customer Needs. *Research in Engineering Design*. 1999;11(1):1–19. doi. 10.1007/s001630050001.

- [154] Singh V, Skiles SM, Krager JE, Wood KL, Jensen D, Sierakowski R. Innovations in Design Through Transformation: A Fundamental Study of Transformation Principles. *Journal of Mechanical Design*. 2009;131(8). doi. 10.1115/1.3125205.
- [155] Yilmaz S, Seifert CM. Cognitive Heuristics in Design Ideation. In: *International Engineering Design Conference - Design 2010*. Dubrovnik, Croatia: The Design Society; 2010.
- [156] McAdams DA. Identification and codification of principles for functional tolerance design. *Journal of Engineering Design*. 2003;14(3):355–75. doi. 10.1080/0954482031000091095.
- [157] Valjak F, Bojčetić N. Functional modelling through Function Class Method: A case from DfAM domain. [Manuscript submitted for publication], Chair for Design and Product Development, University of Zagreb. 2022;
- [158] Kamps T, Biedermann M, Seidel C, Reinhart G. Design approach for additive manufacturing employing Constructal Theory for point-to-circle flows. *Additive Manufacturing*. 2018;20:111–8. doi. 10.1016/j.addma.2017.12.005.
- [159] Sen C, Summers JD, Mocko GM. A protocol to formalise function verbs to support conservation-based model checking. *Journal of Engineering Design*. 2011;22(11–12):765–88. doi. 10.1080/09544828.2011.603295.
- [160] Nagel RL, Vucovich JP, Stone RB, McAdams DA; Signal flow grammar from the functional basis. In: *International Conference On Engineering Design, ICED'07*. Paris: The Design Society; 2007. p. ICED'07/401 (p.10).
- [161] Valjak F, Kosorčić D, Rešetar M, Bojčetić N. Function-Based Design Principles for Additive Manufacturing. *Applied Sciences*. 2022;12(7):3300. doi. 10.3390/app12073300.
- [162] Novak R. Razvoj konstrukcijskih principa temeljenih na mogućnostima DMLS proizvodnog postupka, in Croatian (eng. Development of design principles based on DMLS manufacturing process). University of Zagreb, Faculty of Mechanical Engineering and Naval Architecture; 2021.
- [163] Lukić M. Optimiranje polimernih milireaktora izrađenih aditivnom proizvodnjom, in Croatian (eng. Optimization of polymeric millireactors produced by additive manufacturing). 2021.
- [164] Shah JJ, Smith SM, Vargas-Hernandez N. Metrics for measuring ideation effectiveness. *Design Studies*. 2003;24(2):111–34. doi. 10.1016/S0142-694X(02)00034-0.

- [165] Sen C, Caldwell BW, Summers JD, Mocko GM. Evaluation of the functional basis using an information theoretic approach. *Artificial Intelligence for Engineering Design, Analysis and Manufacturing*. 2010;24(1):87–105. doi. 10.1017/S0890060409990187.
- [166] Sen C, Summers JD, Mocko GM. Topological Information Content and Expressiveness of Function Models in Mechanical Design. *Journal of Computing and Information Science in Engineering*. 2010;10(3). doi. 10.1115/1.3462918.
- [167] Microsoft. Visio. Available from: <https://www.microsoft.com/en-ww/microsoft-365/visio/flowchart-software>
- [168] Teegavarapu S, Summers JD, Mocko GM. Case Study Method for Design Research: A Justification. In: Volume 4: 20th International Conference on Design Theory and Methodology; Second International Conference on Micro- and Nanosystems. ASMEDC; 2008. p. 495–503. doi. 10.1115/DETC2008-49980.
- [169] Bender B, Reinicke T, Wünsche T, Blessing LTM. Application of Methods from Social Sciences in Design Research. In: D. M, editor. DS 30: Proceedings of DESIGN 2002, the 7th International Design Conference, Dubrovnik. 2002. p. 7–16.
- [170] Sheldon DF. Design Review 2005/2006—The ever increasing maturity of design research papers and case studies. *Journal of Engineering Design*. 2006;17(6):481–6. doi. 10.1080/09544820601072387.
- [171] Roth S. The State of Design Research. *Design Issues*. 1999;15(2):18. doi. 10.2307/1511839.
- [172] Yin RK. *Case Study Research and Applications: Design and Methods*. Sixth Edit. SAGE Publications, Inc.; 2018.
- [173] Flyvbjerg B. Five Misunderstandings About Case-Study Research. *Qualitative Inquiry*. 2006;12(2):219–45. doi. 10.1177/1077800405284363.
- [174] Eisenhardt KM. Building Theories from Case Study Research. *Academy of Management Review*. 1989;14(4):532–50. doi. 10.5465/amr.1989.4308385.
- [175] Baxter P, Jack S. Qualitative Case Study Methodology: Study Design and Implementation for Novice Researchers. *The Qualitative Report*. 2015; doi. 10.46743/2160-3715/2008.1573.
- [176] Stowe D. Investigating the Role of Prototyping in Mechanical Design Using Case Study Validation. 2008.
- [177] Hancock DR, Algozzine B. *Doing Case Study Research: A Practical Guide for Beginning Researchers*. Teachers College Press; 2006.

- [178] Hwang D, Lauff CA, Perez KB, Camburn BA, Wood KL. Comparing the Impacts of Design Principles for Additive Manufacturing on Student and Experienced Designers. *International Journal of Engineering Education*. 2020;36(6):1862–76.
- [179] Isaksson O, Eckert C, Panarotto M, Malmqvist J. You need to focus to validate. *Proceedings of the Design Society: DESIGN Conference*. 2020;1:31–40. doi. 10.1017/dsd.2020.116.
- [180] le Dain M-A, Blanco E, Summers JD. Assessing design research quality: Investigating verification and validation criteria. In: *DS 75-2: Proceedings of the 19th International Conference on Engineering Design (ICED13), Design for Harmonies, Vol.2: Design Theory and Research Methodology*, Seoul, Korea, 19-22.08.2013. The Design Society; 2013. p. 183–92.
- [181] Teegavarapu S. *Foundations of design method development*. 2009.
- [182] Agee J. Developing qualitative research questions: a reflective process. *International Journal of Qualitative Studies in Education*. 2009;22(4):431–47. doi. 10.1080/09518390902736512.
- [183] Yin RK. *Case Study Research: Design and Methods*. SAGE Publications, Inc.; 2008.
- [184] Kvale S. *Interviews: An Introduction to Qualitative Research Interviewing*. Frist edit. SAGE Publications, Inc.; 1996.
- [185] Rešetar M. Primjena 3D skeniranja i DMLS postupka aditivne proizvodnje u povratnom inženjerstvu, in Croatian (eng. Application of 3D scanning and DMLS manufacturing process in reversable engineering). University of Zagreb, Faculty of Mechanical Engineering and Naval Architecture; 2022.
- [186] Rešetar M. *Original design*. 2022.
- [187] Vukas P. Razvoj bicikla temeljenog na konstrukcijskim rješenjima za aditivnu proizvodnju, in Croatian (eng. Development of bicycle using design principles for additive manufacturing). University of Zagreb, Faculty of Mechanical Engineering and Naval Architecture; 2022.
- [188] Vukas P. *Original Design*. 2022.
- [189] Taradi I, Kapetanović A. *Original Design*. 2022.
- [190] Zajec T. *Original Design*. 2022.
- [191] Summers JD. Expressiveness of the Design Exemplar. In: *Volume 3: 25th Computers and Information in Engineering Conference, Parts A and B*. ASMEDC; 2005. p. 353–64. doi. 10.1115/DETC2005-85135.

- [192] Blösch-Paidosh A, Shea K. Enhancing Creative Redesign Through Multimodal Design Heuristics for Additive Manufacturing. *Journal of Mechanical Design*. 2021;143(10). doi. 10.1115/1.4050656.
- [193] Goel AK, Bhatta SR. Use of design patterns in analogy-based design. *Advanced Engineering Informatics*. 2004;18(2):85–94. doi. 10.1016/j.aei.2004.09.003.
- [194] Lucero B, Linsey J, Turner CJ. Frameworks for organising design performance metrics. *Journal of Engineering Design*. 2016;27(4–6):175–204. doi. 10.1080/09544828.2015.1135235.
- [195] Caldwell BW, Mocko GM. Functional Similarity at Varying Levels of Abstraction. In: Volume 5: 22nd International Conference on Design Theory and Methodology; Special Conference on Mechanical Vibration and Noise. ASMEDC; 2010. p. 431–41. doi. 10.1115/DETC2010-28970.
- [196] Agyemang M, Linsey J, Turner CJ. Transforming functional models to critical chain models via expert knowledge and automatic parsing rules for design analogy identification. *Artificial Intelligence for Engineering Design, Analysis and Manufacturing*. 2017;31(4):501–11. doi. 10.1017/S0890060417000488.
- [197] Blösch-Paidosh A, Shea K. Industrial evaluation of design heuristics for additive manufacturing. *Design Science*. 2022;8:e13. doi. 10.1017/dsj.2022.8.
- [198] Coolican H. *Research Methods and Statistics in Psychology*. Psychology Press; 2017. doi. 10.4324/9780203769836.
- [199] Pedersen K, Emblemståvåg J, Bailey R, Allen JK, Mistree F. Validating Design Methods and Research: The Validation Square. In: Volume 4: 12th International Conference on Design Theory and Methodology. American Society of Mechanical Engineers; 2000. p. 379–90. doi. 10.1115/DETC2000/DTM-14579.
- [200] Seepersad CC, Pedersen K, Emblemståvåg J, Bailey R, Allen JK, Mistree F. The validation square: how does one verify and validate a design method. *Decision making in engineering design*. 2006;303–14.

BIOGRAPHY

Filip Valjak was born in Zagreb, Croatia, in 1991. He enrolled in the study of Mechanical Engineering at the Faculty of Mechanical Engineering and Naval Architecture, University of Zagreb (UNIZAG-FSB) in 2010. He graduated in 2015 with a specialisation in Product Design and Development with the master thesis entitled “Knowledge recording and communication support in complex design project”. After graduation, he worked in Klex d.o.o. as an engineer for product development and additive manufacturing. At the same time, he worked as an external assistant lecturer in the course Computer and Engineering Graphics at UNIZAG-FSB.

Since November 2016, he has worked as a research and teaching assistant at the Chair of Design and Product Development at UNIZAG-FSB. The same year he enrolled in postgraduate doctoral studies at the same institution. His primary field of research and scientific focus is Design for Additive Manufacturing.

He currently participates in the Croatian Science Foundation project “Hurdle technology and 3D printing for sustainable fruit juice processing and preservation (3D-SustJuice)”. From 2018 to 2022, he was part of the HORIZON 2020 Programme project “Increasing Excellence on Advanced Additive Manufacturing – INEX-ADAM”. In 2017 he participated in Erasmus+ project “Networked Activities for Realisation of Innovative Products – NARIP”.

During his PhD Studies, Filip attended two international summer schools: “Summer school on engineering design research” at the Technical University of Denmark, and “IDEA League Summer School – Computational Design for Additive Manufacturing” at the Technical University Delft. Through INEX-ADAM project he visited Lund University, and through Erasmus+ programme he visited Luleå Technical University.

Besides the scientific work, he assists in teaching through UNIZAG-FSB undergraduate and graduate study courses Product Development, Computer Aided Design, Technical Information Systems, and Knowledge Management. He also worked on educational projects with industry (Yazaki Europe Limited and Sinago d.o.o.)

He is a member of the Design Society. Since 2018 he has participated in the organisation of the DESIGN conference.

ŽIVOTOPIS

Filip Valjak rođen je u Zagrebu 1991. godine. Studij strojarstva upisao je 2010. godine na Fakultetu strojarstva i brodogradnje, Sveučilišta u Zagrebu (UNIZG-FSB). Diplomirao je 2015. na usmjerenju Konstruiranje i razvoj proizvoda. Nakon diplome radi u poduzeću Klex d.o.o. kao inženjer za razvoj proizvoda i aditivnu proizvodnju. Istovremeno, kao vanjski suradnik, sudjeluje u izvođenju nastave na UNIZG-FSB u sklopu kolegija Računalna i inženjerska grafika.

Od studenog 2016. godine radi kao asistent na Katedri za konstruiranje i razvoj proizvoda. Iste godine upisuje i doktorski studij na UNIZG-FSB. Glavno područje njegovog istraživanja je konstruiranje za aditivnu proizvodnju.

Trenutno je suradnik na projektu Hrvatske zaklade za znanost „Tehnologija preprekama i 3D printanje za okolišno prihvatljivu proizvodnju funkcionalnih voćnih sokova (3D-SustJuice)“. Od 2018. do 2022. godine bio je suradnik na projektu OBZOR 2020 „*Increasing Excellence on Advanced Additive Manufacturing – INEX-ADAM*“. U 2017. godini bio je suradnik na Erasmus + projektu „*Networked Activities for Realisation of Innovative Products – NARIP*“.

Tijekom doktorskog studija, Filip Valjak je sudjelovao u dvije ljetne škole: „*Summer school on engineering design research*“ na Danskom tehničkom sveučilištu, te „*IDEA League Summer School – Computational Design for Additive Manufacturing*“ na Tehničkom sveučilištu Delft. Također sudjelovao je u istraživačkim boravcima na Sveučilištu Lund i Tehničkom sveučilištu Luleå.

Uz znanstveni rad, Filip Valjak sudjeluje u izvođenju nastave na preddiplomskim i diplomskim kolegijima na UNIZG-FSB. Također surađivao je na edukacijskim projektima s industrijom.

Član je zajednice *The Design Society*. Od 2018. sudjeluje u organizaciji međunarodne DESIGN konferencije.

BIBLIOGRAPHY

Journal Papers

- Valjak, Filip; Kosorčić, Dora; Rešetar, Marija; Bojčetić, Nenad. (2022) Function-Based Design Principles for Additive Manufacturing. *Applied Sciences*, 12(7), pp. 1-17. doi:10.3390/app12073300
- Tomašević, Igor; Putnik, Predrag; Valjak, Filip; Pavlić, Branimir; Šojić, Branislav; Bebek Markovinović, Anica; Bursać Kovačević, Danijela. (2021) 3D printing as novel tool for fruit-based functional food production. *Current opinion in food science*, 41, pp. 138-145. doi:10.1016/j.cofs.2021.03.015
- Bojčetić, Nenad; Dragan, Žeželj; Tomislav Martinec; Filip Valjak. (2021) Automated Evaluation of Students' CAD Models, *Education Sciences*, 11(4), pp. 1-18. doi:10.3390/educsci11040145
- Bojčetić, Nenad; Valjak, Filip; Flegarić, Stjepan; Štorga, Mario. (2020) Application for Product Functional Model Creation. *Tehnički vjesnik*, 27(3), pp. 883-890. doi:10.17559/TV-20190923203841

Conference Papers

- Valjak, Filip; Lindwall, Angelica. (2021) Review of design heuristics and design principles in design for additive manufacturing. In: *Proceedings of the Design Society, Volume 1, 23rd International Conference on Engineering Design (ICED21)*, Göteborg, Sweden, Cambridge University Press, pp. 2571-80. doi:10.1017/pds.2021.518
- Borgue, Olivia; Valjak, Filip; Panarotto, Massimo; Isaksson, Ola. (2020) Supporting additive manufacturing technology development through constraint modelling in early conceptual design: A satellite propulsion case study. In: *Proceedings of the Design Society: DESIGN Conference*, Dubrovnik, Croatia, Cambridge University Press, pp. 817-826. doi:10.1017/dsd.2020.289
- Valjak, Filip; Bojčetić, Nenad; Nordin, Axel; Godec, Damir. (2020) Conceptual design for additive manufacturing: An explorative study. In: *Proceedings of the Design Society: DESIGN Conference*, Dubrovnik, Croatia, Cambridge University Press, pp. 441-450. doi:10.1017/dsd.2020.307
- Valjak, Filip; Bojčetić, Nenad. (2019) Conception of Design Principles for Additive Manufacturing. In: *Proceedings of the Design Society: International Conference on Engineering Design*, Cambridge University Press, pp. 689-698. doi:10.1017/dsi.2019.73

- Valjak, Filip; Bojčetić, Nenad; Lukić, Marija. (2018) Design for Additive Manufacturing: Mapping of product functions. In: *Proceedings of the 15th International Design Conference (DESIGN 2018)*, pp. 1369-1380. doi:10.21278/idc.2018.0364
- Bojčetić, Nenad; Žeželj, Dragan; Salopek, Damir; Valjak, Filip. (2017) A tool to support project time evaluation, *Proceedings of the 21st International Conference on Engineering Design (ICED17), Vol. 2: Design Processes | Design Organisation and Management*, Cambridge University Press, pp. 001-010.

This page intentionally left blank.

Appendix A

Illustrative Example

To illustrate the use case scenario of the Mapping Methodology, a redesign of the screwdriver is presented. The screwdriver is chosen as it is a simple mechanical device with a low number of functions that will clearly and comprehensively show the phases and steps of the Mapping Methodology. The redesign example follows the framework of the Mapping Methodology shown in Figure 4.1. Each of the three stages of the Mapping Methodology is described in a separate subsection.

Before the application of the Mapping Methodology can begin, user needs and design requirements used as input must be defined. This is part of the planning phase of the design process. For an example of a screwdriver, some of the requirements could be defined as:

- it is solely powered by human energy,
- must provide a good grip,
- it is used for tightening and loosening screws with PH2 head.

A.1 Function Modelling

The first stage of the Mapping Methodology is function modelling using the FC Method. Therefore, the framework shown in Figure 4.4 is followed for the function modelling of a screwdriver. The function modelling process starts with the optional creation of the Black Box model. The main product function is identified as *Tighten/Loosen Screw*, this is followed by identifying the main input flows (*Screw*, *Hand*, and *Human Energy*) and output flows (*Tighten/Loosen Screw*, *Torque in Screw*, *Hand*, and *Reaction Forces*) that together make a Black Box model (Figure A.1, left). This Black Box model is defined using a natural language and is not following the predefined vocabulary from Section 4.2.2. Here, it is a good practice to define a Black Box using predefined vocabulary as abstract thinking about flows will facilitate the use of FCs in the next phase (Figure A.1, right). Before proceeding with the function modelling process, the sum of inputs is compared to the sum of outputs to check the conservation rule.

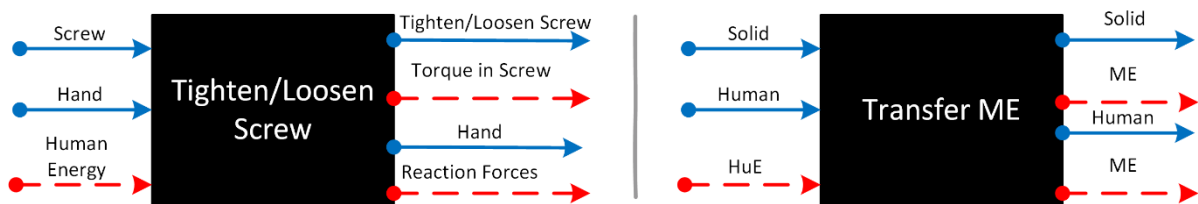

Figure A.1 Black Box model of a screwdriver;
Left: with natural language, Right: with predefined vocabulary

The second phase of the function modelling process starts with adding FCs for functions *Import* and *Export*, and continues with other easily identifiable subfunctions. For example, some subfunctions are *Position Human*, *Convert HuE to ME* and *Transfer ME* (Figure A.2). After adding FCs, they are connected with appropriate flows following the modelling rules (Figure A.3).

After this process, some flows are dangling, and additional subfunctions are identified. For example, additional subfunctions could be function *Guide ME* and *Position Solid*. Finally, new FCs are added and connected with flows in an iterative process until the final function structure is created and checked for compliance with FC Method (Figure A.4).

Appendix A. Illustrative Example

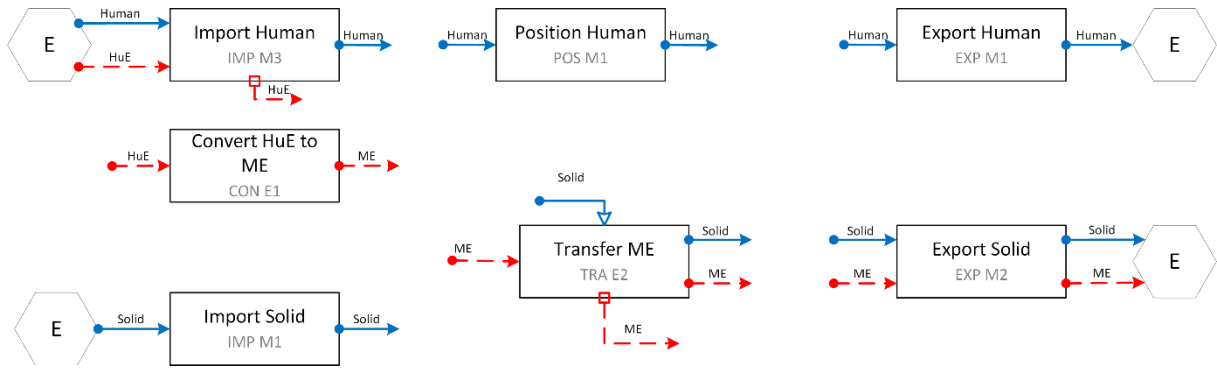

Figure A.2 Initial Placement of FCs

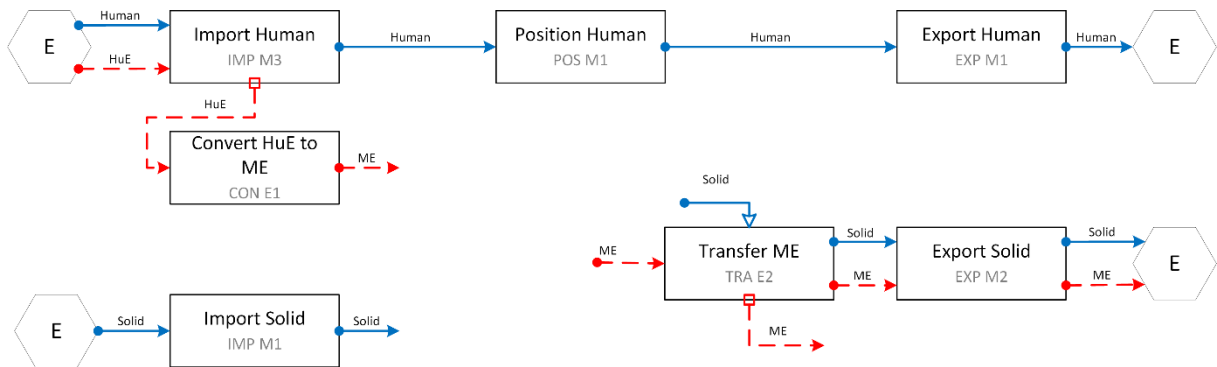

Figure A.3 Connecting FCs with flows

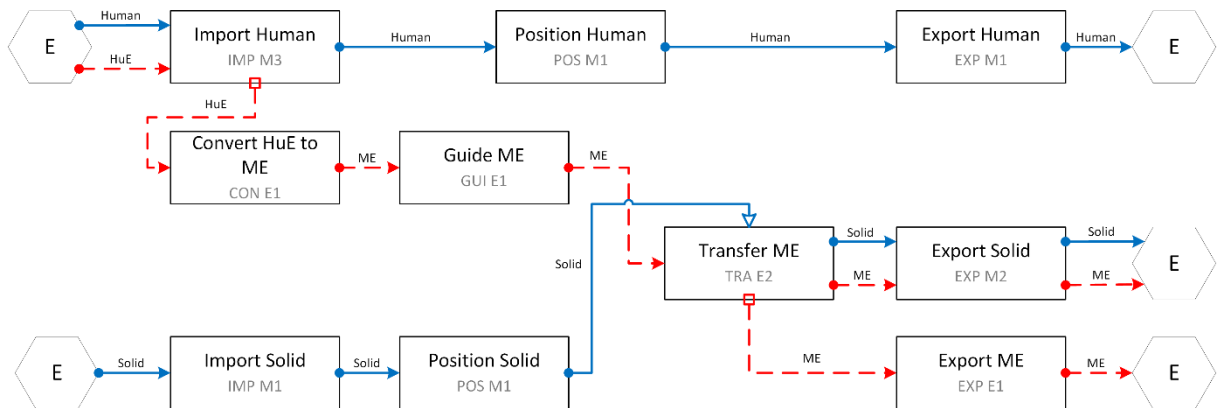

Figure A.4 Function structure of Screwdriver

The final phase of the FC Method is a reflection on the function modelling process and the creation of alternative function structures that can have some different or additional functions and flows. An alternative function structure for the screwdriver is created following the same process (Figure A.5). The function structure represents the additional design requirement of communicating the screwdriver size to the user achieved by adding an additional function chain operating on the status flow.

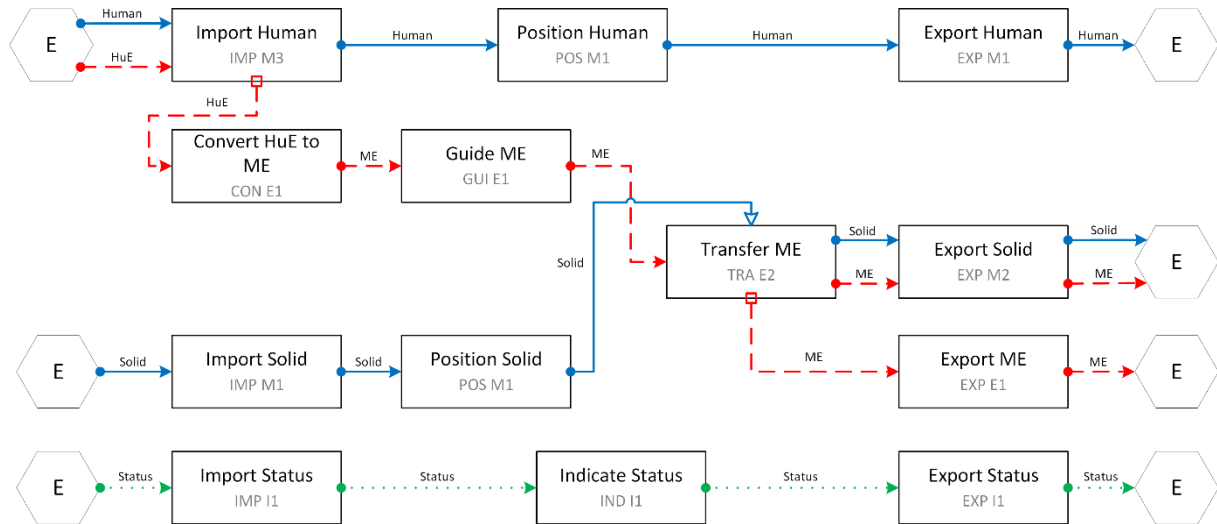

Figure A.5 Alternative function structure of Screwdriver

A.2 Mapping Process

The second stage of the Mapping Methodology is the mapping process (Figure 4.1) conducted through the Mapping Method. The process follows the method's framework shown in Figure 4.8 and uses the FM App to find the possible MRs and AM DPs. The mapping process starts with the function structure of a screwdriver (Figure A.4) as an input. Firstly, the function for starting the mapping process is identified. In this case, the mapping started with the function *Position Solid*, for which four MRs are suggested (Figure A.6). The MR BR-CH5 is used to map a block of four functions and the #DP6. The process continues with another unmapped function, for example, with function *Guide ME*. For this function, only one MR is suggested, but 5 different DPs could be used to map the function. The process continues until all functions are mapped or intentionally left unmapped and the MFP Structure is created (Figure A.8).

The mapping process is repeated on the same function structure but with a different combination of applied MRs and DPs. This creates an alternative MFP Structure and the layout of the product for concept generations (Figure A.9). This increases the number of generated ideas, consequently increasing the chances of generating better ideas [164]. Finally, following the same logic MFP Structure for the second function structure of a screwdriver is created (Figure A.10).

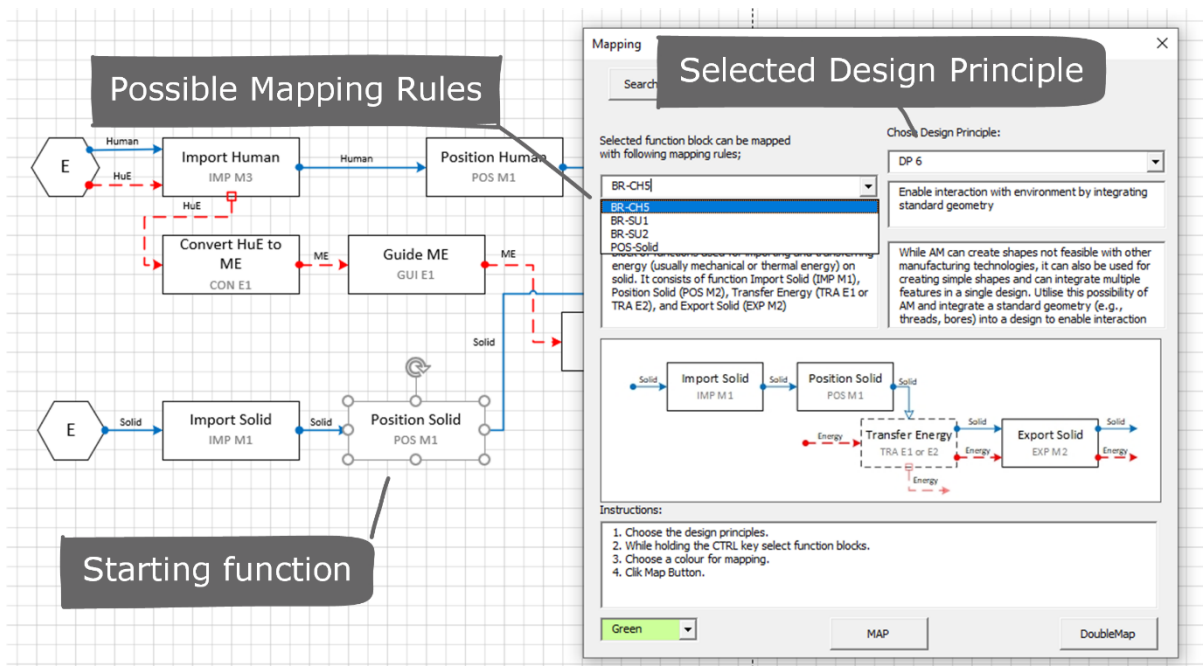

Figure A.6 Beginning of the mapping process in the FM App

Appendix A. Illustrative Example

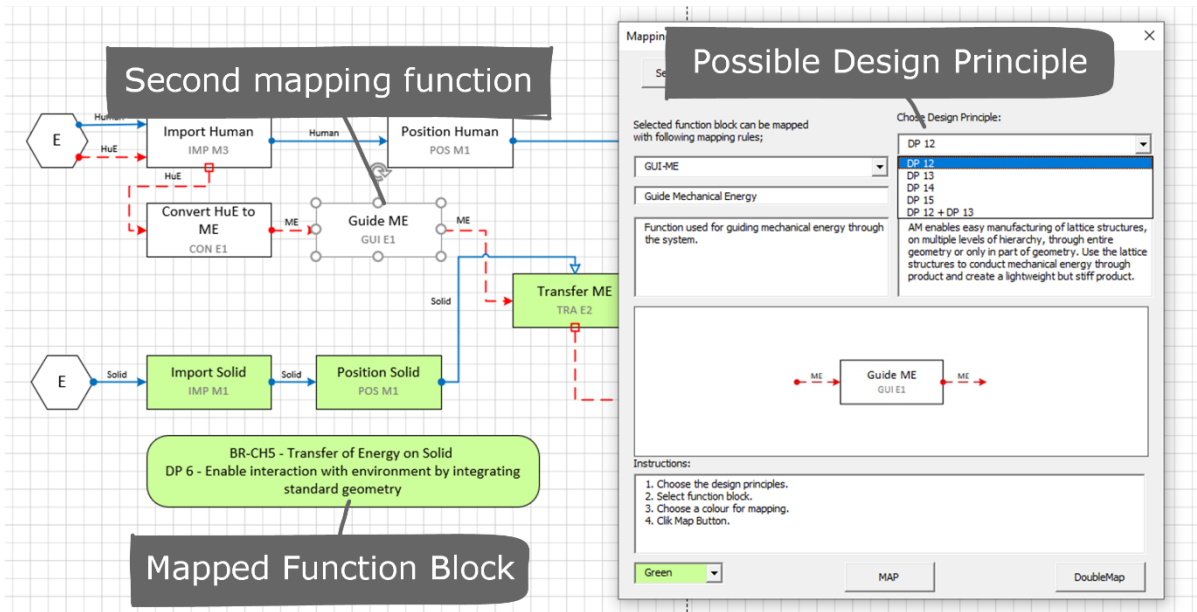

Figure A.7 Second mapping in the FM App

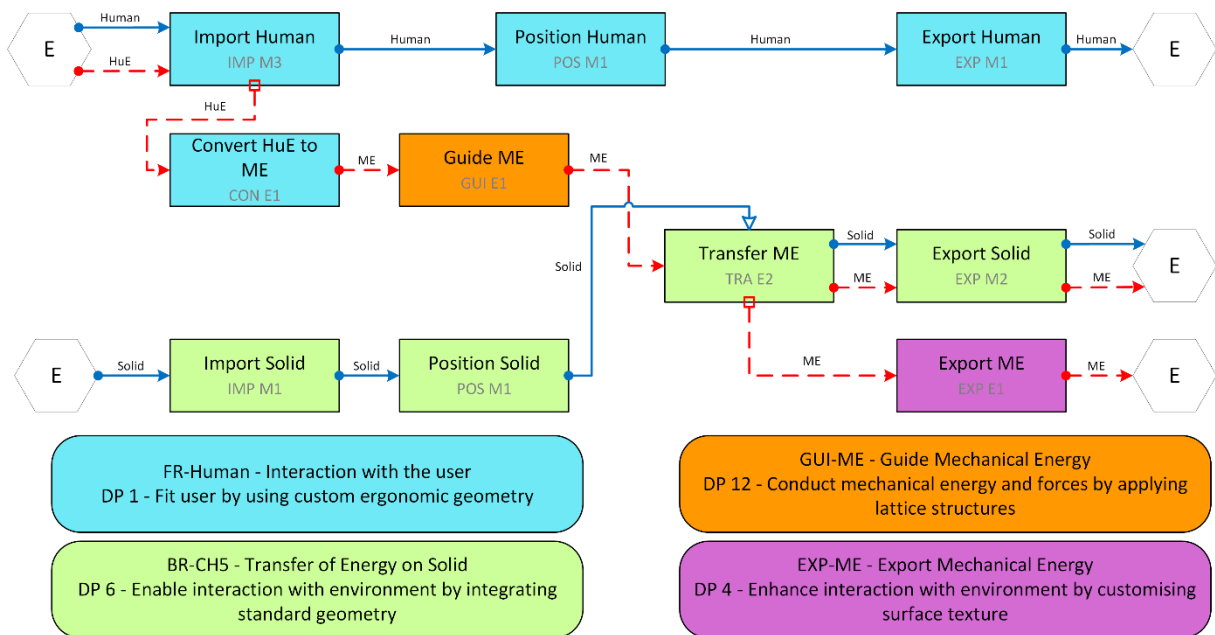

Figure A.8 MFP Structure 1 of a Screwdriver for first function structure

Appendix A. Illustrative Example

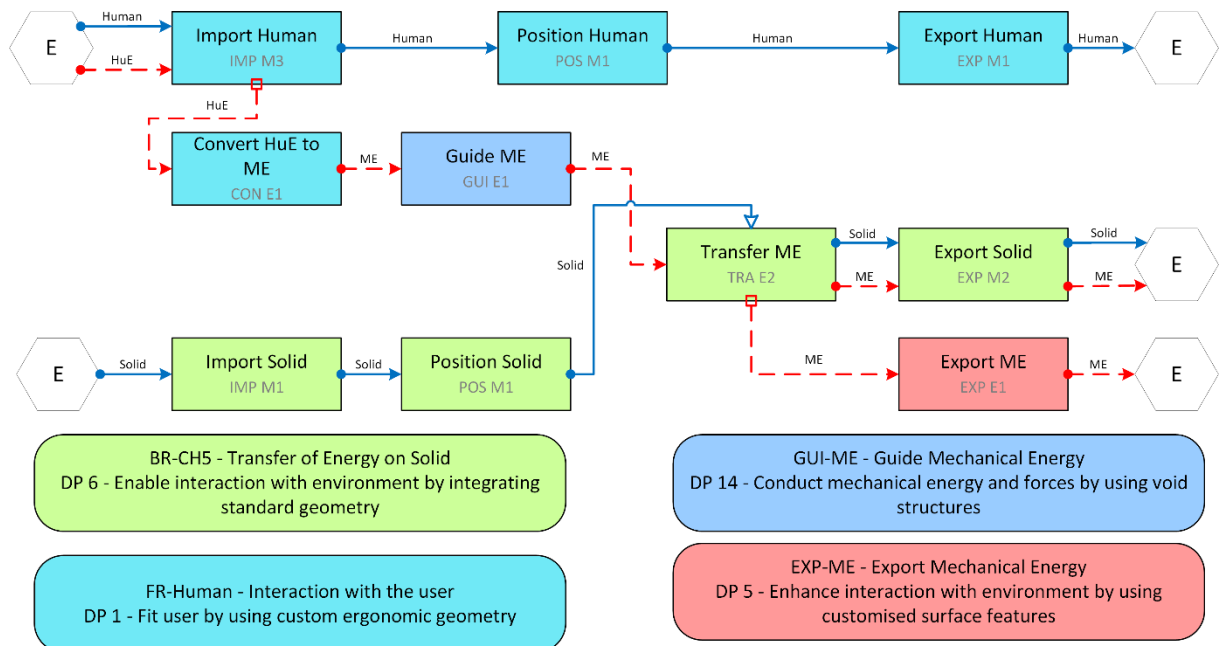

Figure A.9 MFP Structure 2 of a Screwdriver for first function structure

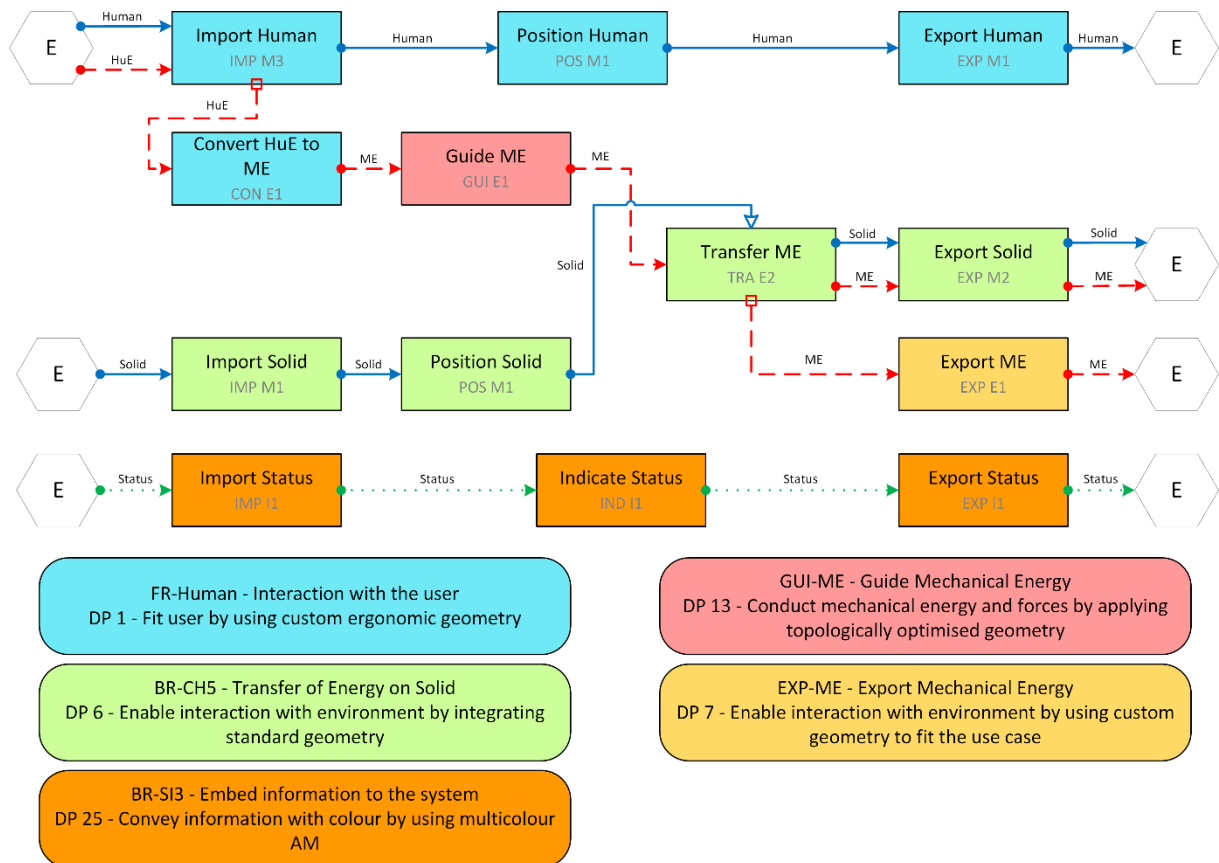

Figure A.10 MFP Structure of a Screwdriver for second function structure

| A.3 Concept Generation

The final stage of the Mapping Methodology is the generation of concepts based on the created MFP Structures. Figure A.11 shows the three concepts of an AM Screwdriver. Each concept corresponds to one MFP Structure.

The first concept is generated using the MFP Structure shown in Figure A.8. The concept utilises the ergonomically shaped handle to enhance interaction with the user (#DP1). As the screwdriver must interact with the standard screw, its tip integrates the appropriate geometry for the PH2 screw (#DP6). The mechanical energy and forces are guided through the body of a screwdriver that is filled with lattice structures (#DP12). This enables lightweight construction while providing the required stiffness for operational use. Furthermore, the concept uses the surface texture (#DP4) on the handle to provide a better grip for the user.

The second concept is generated using the MFP Structure shown in Figure A.9. Similarly to the first concept, the second concept also utilises the #DP1 and #DP6 for the same set of product functions for interaction with the user and the screw. However, the novelty of the second concept is the utilisation of void structures in the body of the screwdriver for conducting mechanical energy (#DP14). Finally, instead of the surface texture, the concept uses small features on the handle's surface to provide a better grip for the user (#DP5).

The third concept is generated using the MFP Structure shown in Figure A.10. The concept also utilises the #DP1 and #DP6 for the interaction with the user and the screw. In addition, the concept utilises the topologically optimised structures in the body of the screwdriver for conducting mechanical energy (#DP13). This concept is made from an alternative function structure with the additional function chain representing the embedded information into the product. It utilises the MMAM to solve this function chain by embedding information about the screwdriver size in a different colour (#DP25)

With this, the Mapping Methodology is conducted, and the concepts proceed to the next phases of the design process.

Appendix A. Illustrative Example

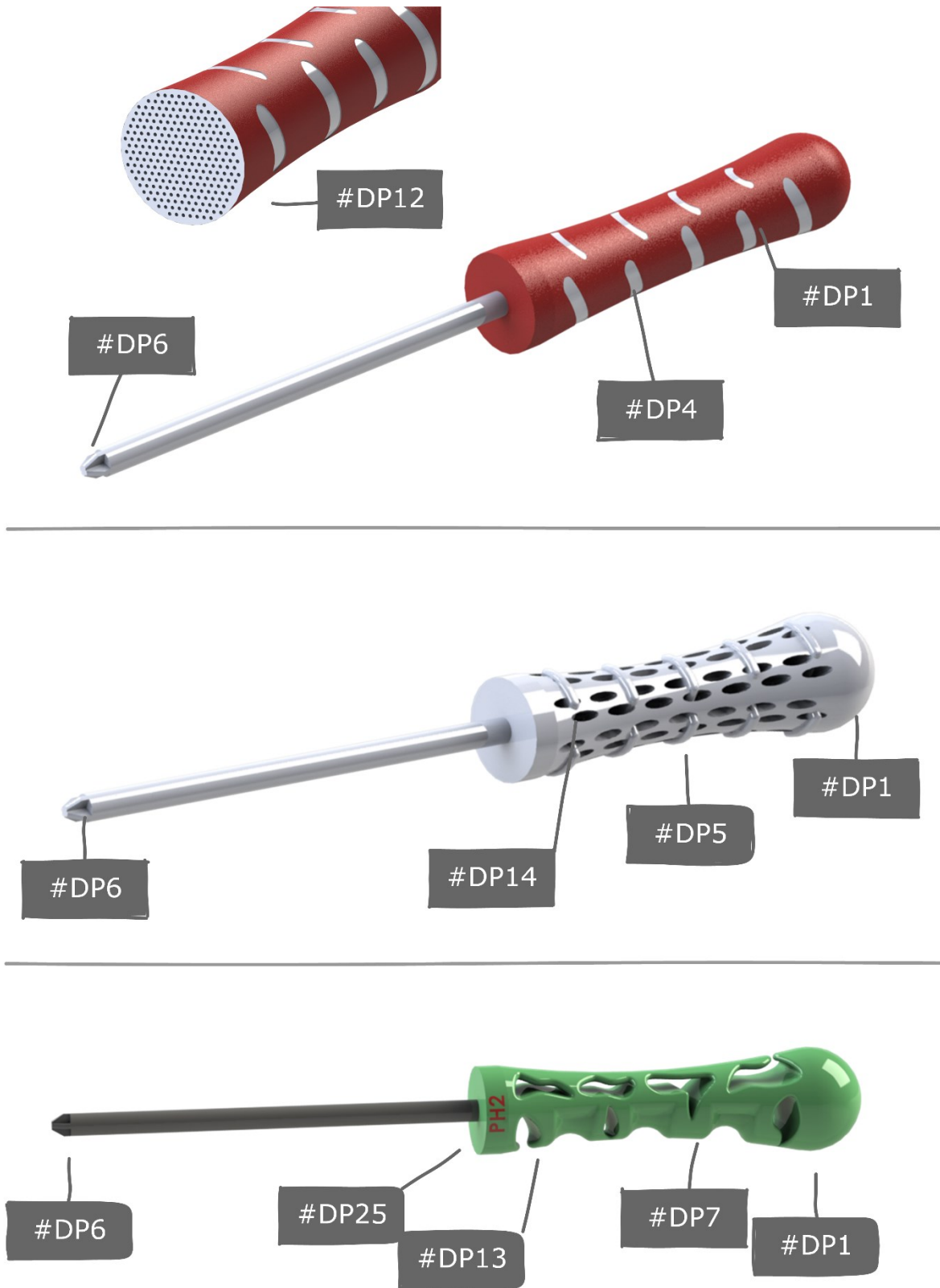

Figure A.11 Concepts of an AM Screwdriver

Appendix B

FC Method

This appendix is based the submitted paper [157].

B.1 Primary Rules

A. Function and flow can be described only with terms from the given vocabulary.



B. Function of a product (function block) is expressed in function + flow format (e.g., Import Gas). Exception of the rule:

- Function Convert: Convert Flow1 to Flow2
- Function Mix: Mix Flow1 and Flow2
- Function Couple: Couple Flow1 and Flow2
- Function Allow DOF: Allow DOF (Function of the system without a flow on which it operates)

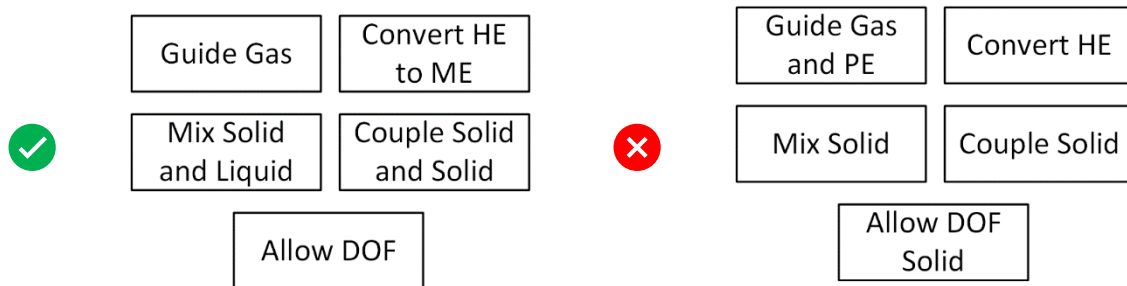

C. Flows of energy and material must follow the conservation law. Every flow that enters the system can change the form but must exist the system. No flow of energy and material can just appear or disappear in the system.



D. Information flow should be primarily modelled as an independent abstract flow that do not need to follow the conservation law.



E. Each function block must have at least one input and one output flows.

F. Enabling flow is a supporting flow needed for function operation.

G. Auxiliary flow represents a secondary output flow.

H. Flow of any type can have one or more children, all of which must of the same type (one-in-many-output).

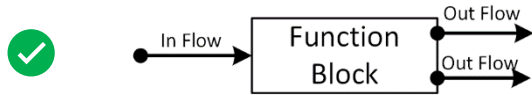

I. Flow of any type can have one or more parents, all of which must be of the same type (many-in-one-output).

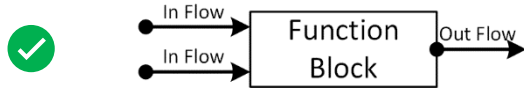

J. Set of flows can be children of another set of the same type (many-in-many-out).

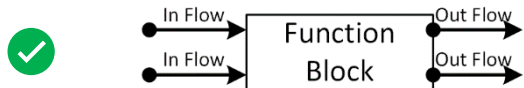

K. Flow cannot be output and input to the same function block or environment.

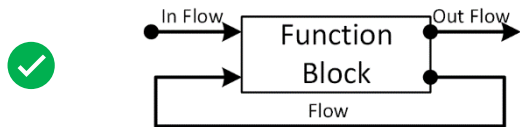

L. When Carrier-Carried relation between input flows exist, a function always operates on a carrier flow (except in the case of functions of energy Transfer and Conversion).

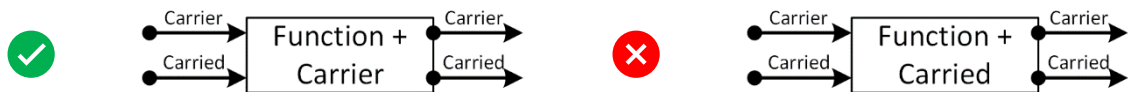

M. Due to flow independency, each Carrier flow can carry one Carried flow. Carried flow can have only one Carrier at the time.

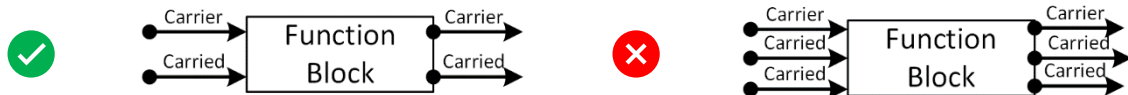

N. Material flow can carry only Energy and Information flows.

O. Energy flow can carry only Information flows.

P. Signal flow cannot carry any flow





B.2 Function Classes

		Textual Definition		
Code		Graphical Template	Class definition	
Separate	SEP M1	<p>Separating material into two or more distinctive flows using an energy source.</p> <p><i>Example:</i> Bottle opener separates cap (solid) from the bottle (solid).</p>	<p>OF_Type = M In_Type = M, n = 1 Out_Type = M (=In), n = 2 En_Type = E, n = 1 Aux_Type = E (=In), n = 1</p>	
		<p>Distributing energy into numerous smaller flows not distinguishable from each other and on which the same set of functions is applied; thus, only one exit flow is modelled.</p> <p><i>Example:</i> Lens distributes focused beam of light into a dispersed light.</p>	<p>OF_Type = E In_Type = E, n = 1 Out_Type = E (=In), n = 1</p>	
BRANCH	DIS E2	<p>Distributing energy into two or more distinctive flows on which different set of functions operate.</p> <p><i>Example:</i> In a cherry pitter, a flow of mechanical energy is distributed on flow for performing separation and flow for compressing spring.</p>	<p>OF_Type = E In_Type = E, n = 1 Out_Type = E (=In), n = 2</p>	
		<p>Distributing material into numerous smaller flows not distinguishable from each other and on which the same set of functions is applied; thus, only one exit flow is modelled.</p> <p><i>Example:</i> Internal channel distributes coolant across the tool with conformal tooling.</p>	<p>OF_Type = M In_Type = M, n = 1 Out_Type = M (=In), n = 1</p>	
	Distribute	DIS M2	<p>Distributing material with the carried energy into numerous smaller flows not distinguishable from each other and on which the same set of functions is applied; thus, only one exit flow material is modelled.</p> <p><i>Example:</i> Fuel injectors distributes the aerosol of fuel that is a carrier of chemical energy.</p>	<p>OF_Type = M In_Type = M, n = 1; E, n = 1 Out_Type = M (=In), n = 1; E (=In), n = 1</p>

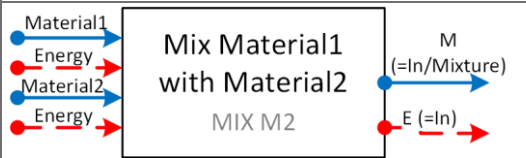

CHANNEL	Import	<p>IMP E1</p> <p>Import energy from outside the system boundaries into the system. The energy does not have a carrier, or the carrier is ignored. <i>Example:</i> Handle on the screwdriver imports the human energy into the system.</p>		<p>OF_Type = E In_Type = E, n = 1 Out_Type = E (=In), n = 1</p>
		<p>IMP M1</p> <p>Import material from outside the system boundaries into the system. <i>Example:</i> Pneumatic fittings import gas into the system.</p>		<p>OF_Type = M In_Type = M, n = 1 Out_Type = M (=In), n = 1</p>
		<p>IMP M2</p> <p>Import material and energy flows in a carrier/carried relation from outside the system boundaries into the system. Flows continue in this relation throughout the system. <i>Example:</i> Pneumatic fittings import gas with chemical energy into the system</p>		<p>OF_Type = M In_Type = M, n = 1; E, n = 1 Out_Type = M (=In), n = 1; E (=In), n = 1</p>
		<p>IMP M3</p> <p>Import material and energy in a carrier/carried relation from outside the system boundaries into the system. The energy is separated from the material and continues as an independent flow. <i>Example:</i> Push-button imports human material and human energy simultaneously, but they continue as independent flows through system.</p>		<p>OF_Type = M In_Type = M, n = 1; E, n = 1 Out_Type = M (=In), n = 1 Aux_Type = E (=In), n = 1</p>
		<p>IMP M4</p> <p>Active import of material. To import material energy is needed that will enable import into the system. <i>Example:</i> For a clip to hold an object, it requires an active import of material, enabled by mechanical energy and movement of the clip.</p>		<p>OF_Type = M In_Type = M, n = 1 Out_Type = M (=In), n = 1 En_Type = E, n = 1 Aux_Type = E (=In), n = 1</p>
		<p>IMP I1</p> <p>Import of information into the system. <i>Example:</i> The embedded warning signs are imported into the system.</p>		<p>OF_Type = I In_Type = I, n = 1 Out_Type = I (=In), n = 1</p>

CHANNEL	Export	<p>EXP E1</p> <p>Export energy from the system to the outside of system boundaries. The energy does not have a carrier, or the carrier is ignored. <i>Example:</i> The mounting point exports mechanical energy (reaction forces) onto the environment.</p>		<p>OF_Type = E In_Type = E, n = 1 Out_Type = E (=In), n = 1</p>
		<p>EXP M1</p> <p>Export material from the system to the outside of system boundaries. <i>Example:</i> Air diffuser enables the export of air (gas) from the system to the environment.</p>		<p>OF_Type = M In_Type = M, n = 1 Out_Type = M (=In), n = 1</p>
		<p>EXP M2</p> <p>Export material and energy in a carrier/carried relation from the system to outside of system boundaries. <i>Example:</i> Rocket engine exports gas that contains mechanical and thermal energy.</p>		<p>OF_Type = M In_Type = M, n = 1; E, n = 1 Out_Type = M (=In), n = 1; E (=In), n = 1</p>
		<p>EXP M3</p> <p>Active export of material. To export material energy is needed to enable export. The energy exits the system as an auxiliary flow. <i>Example:</i> A clip release an object with mechanical energy and movement of the clip.</p>		<p>OF_Type = M In_Type = M, n = 1 Out_Type = M (=In), n = 1 En_Type = E, n = 1 Aux_Type = E (=In), n = 1</p>
		<p>EXP I1</p> <p>Export of information from the system to the outside of system boundaries. <i>Example:</i> Warning markings export the embedded information to the user.</p>		<p>OF_Type = I In_Type = I, n = 1 Out_Type = I (=In), n = 1</p>
		Transfer	TRA E1	<p>TRA E1</p> <p>Transfer of energy onto the carrier material. The enabling flow of material is needed. Output flows of material and energy are in a carrier/carried relation. <i>Example:</i> Slingshot transfer the mechanical energy on the object.</p>

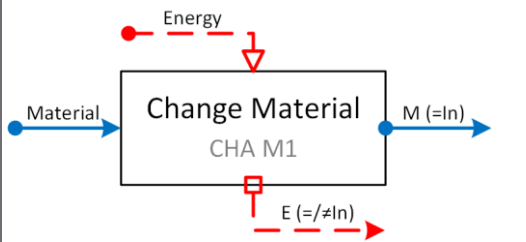
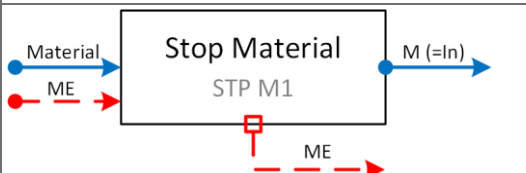
CHANNEL	Transfer	<p>Transfer of energy onto the carrier material. The enabling flow of material is needed. Output flows of material and energy are in a carrier/carried relation. Additional auxiliary flow is added to represent losses of energy. <i>Example:</i> Gear transfers the mechanical energy on second gear with losses in the form of thermal energy due to friction.</p>	
			<p>OF_Type = E In_Type = E, n = 1 Out_Type = M (=In), n = 1; E (=/In), n = 1 En_Type = M, n = 1 Aux_Type = E (=In), n = 1</p>
		<p>Transfer of energy from carrier material onto the system. The main output flow is energy, while the material is the auxiliary flow. <i>Example:</i> Rotary blades transfer the mechanical energy of moving air on the system.</p>	
		<p>OF_Type = E In_Type = M, n = 1; E, n = 1 Out_Type = E (=/In), n = 1 Aux_Type = M (=In), n = 1</p>	
	Guide	<p>Guiding energy through the system. <i>Example:</i> Topologically optimised bracket guides mechanical energy from one side of the bracket to the other.</p>	
			<p>OF_Type = E In_Type = E, n = 1 Out_Type = E (=In), n = 1</p>
<p>Guiding material through the system. <i>Example:</i> Internal channels guide fluids through the system.</p>			
		<p>OF_Type = M In_Type = M, n = 1 Out_Type = M (=In), n = 1</p>	
<p>Guiding material and energy in a carrier/carried relation through the system. <i>Example:</i> Internal channels guide liquid fuel (chemical energy) through the system.</p>			
	<p>OF_Type = M In_Type = M, n = 1; E, n = 1 Out_Type = M (=In), n = 1; E (=In), n = 1</p>		
<p>Guiding material and energy in a carrier/carried relation through the system with the occurrence of energy losses. <i>Example:</i> The surface of the aerofoil guides air (gas) that carries mechanical energy. Due to friction, energy losses occur as thermal energy.</p>			
	<p>OF_Type = M In_Type = M, n = 1; E, n = 1 Out_Type = M (=In), n = 1; E (=In), n = 1 Aux_type = E (=/In), n = 1</p>		

CHANNEL	Allow DOF	ALL E1	<p>A function that represents the movement of the system. No flow on which it operates. Input and output must be mechanical energy. <i>Example:</i> Living hinge enables movement of the lid on a single piece box.</p>
		 <p>OF_Type = E In_Type = E, n = 1 Out_Type = E (=In), n = 1</p>	
CONNECT	Mix	MIX M1	<p>Combining two (or more) material flows into a single flow. <i>Example:</i> In a self-watering planter, soil (solid) is mixed with water (Liquid).</p>
		 <p>OF_Type = M In_Type = M, n = 2 Out_Type = M (=In), n = 1</p>	
CONNECT	Mix	MIX M2	<p>Combining two (or more) material flows with carried energy into a single flow. Both carried energy flows must be the same type of energy. <i>Example:</i> In a fuel nozzle, liquid fuel is mixed with liquid oxygen, and both flows are carriers of CE.</p>
		 <p>OF_Type = M In_Type = M, n = 2; E, n = 2 Out_Type = M (=In/Mixture), n = 1; E (=In), n = 1</p>	
CONTROL MAGNITUDE	Change	CHA E1	<p>Adjusting the energy in a predefined manner. <i>Example:</i> A set of planetary gears change the mechanical energy in a predefined manner with a fixed-gear transmission ratio.</p>
		 <p>OF_Type = E In_Type = E, n = 1 Out_Type = E (=In), n = 1</p>	
		<p>To model, form, or shape material in a new form. <i>Example:</i> Forming tool changes and form sheet metal in the desired shape.</p>  <p>OF_Type = M In_Type = M, n = 1 Out_Type = M (=In), n = 1 En_Type = E, n = 1 Aux_Type = E (=In), n = 1</p>	
CONTROL MAGNITUDE	Stop	STP M1	<p>To stop material and its mechanical energy in its path. <i>Example:</i> Bike helmet stops the contact of an object or a surface with the head with the occurrence of reaction force.</p>
		 <p>OF_Type = M In_Type = M, n = 1; E, n = 1 Out_Type = M (=In), n = 1 Aux_type = E (=In), n = 1</p>	

CONVERT	Convert	<p>CON E1</p> <p>The conversion of energy from one form to another. Output energy flow must be different from the input energy flow. <i>Example:</i> Human energy is converted to mechanical energy upon entering the system.</p>		<p>OF_Type = E In_Type = E, n = 1 Out_Type = E (#In), n = 1</p>
		<p>CON E2</p> <p>The conversion of energy from one form to another. The input material flow carries the input energy. Output energy flow must be different from the input energy flow. <i>Example:</i> Pneumatic energy contained in the gas is converted to mechanical energy of the gas.</p>		<p>OF_Type = E In_Type = M, n = 1; E, n = 1 Out_Type = M (#In), n = 1; E (#In), n = 1</p>
		<p>CON E3</p> <p>The conversion of energy from one form to another. The input material flow carries the input energy. Output energy flow must be different from the input energy flow. In conversion, significant energy losses occur. <i>Example:</i> Chemical energy of liquid fuel is converted into the mechanical energy of gas with the occurrence of thermal energy losses.</p>		<p>OF_Type = E In_Type = M, n = 1; E, n = 1 Out_Type = M (#In), n = 1; E (#In), n = 1 Aux_type = E (#In), n = 1</p>
		<p>CON M1</p> <p>The conversion of material from one state to another. An energy source enables conversion. Energy exits the system as a carried flow of output material flow. <i>Example:</i> Water is converted into steam using thermal energy that is then contained in steam.</p>		<p>OF_Type = E In_Type = M, n = 1 Out_Type = M (#In), n = 1; E (#In), n = 1 En_Type = E, n = 1 Aux_type = E (#In), n = 1</p>
		<p>STO E1</p> <p>Storing of accumulated energy. <i>Example:</i> Compression spring is storing mechanical energy.</p>		<p>OF_Type = E In_Type = E, n = 1 Out_Type = E (=In), n = 1</p>
PROVISION	Store	<p>STO M1</p> <p>Storing of material. <i>Example:</i> The water tank stores the water.</p>		<p>OF_Type = M In_Type = M, n = 1 Out_Type = M (=In), n = 1</p>

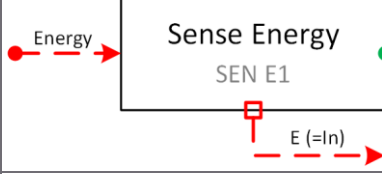
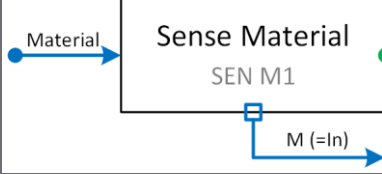
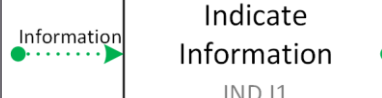
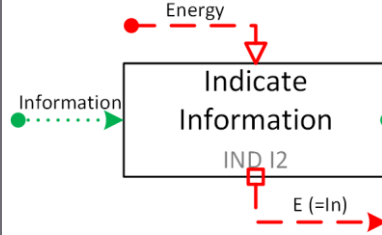
PROVISION	Supply	<p>SUP E1</p> <p>To provide energy accumulated in storage. <i>Example:</i> Compression spring supplies mechanical energy for a mechanism to move into the initial position.</p> 	<p>OF_Type = E In_Type = E, n = 1 Out_Type = E (=In), n = 1</p>
		<p>SUP M1</p> <p>To provide material stored accumulated in storage. <i>Example:</i> Holes on self-watering planter supply water needed for watering plants.</p> 	<p>OF_Type = M In_Type = M, n = 1 Out_Type = M (=In), n = 1</p>
SENSE	Sense	<p>SEN E1</p> <p>To perceive a piece of information about the flow of energy. <i>Example:</i> Colour changing material detects a temperature change.</p> 	<p>OF_Type = E In_Type = E, n = 1 Out_Type = I, n = 1 Aux_Type = E (=In), n = 1</p>
		<p>SEN M1</p> <p>To perceive a piece of information about the flow of material. <i>Example:</i> Scale on measuring cup detects the quantity of sugar in the cup.</p> 	<p>OF_Type = M In_Type = M, n = 1 Out_Type = I, n = 1 Aux_Type = M (=In), n = 1</p>
SIGNAL	Indicate	<p>IND I1</p> <p>To show information to the user. <i>Example:</i> Scale on measuring cup after detection shows the quantity of sugar in the cup.</p> 	<p>OF_Type = I In_Type = I, n = 1 Out_Type = I (=In), n = 1</p>
		<p>IND I2</p> <p>To show information to the user. The enabling energy is needed to show the information. <i>Example:</i> The warning sign embedded in the product is indicated to the user when light passes through it.</p> 	<p>OF_Type = I In_Type = I, n = 1 Out_Type = I (=In), n = 1 En_Type = E, n = 1 Aux_Type = E (=In), n = 1</p>

SUPPORT	Secure	<p>SEC M1</p> <p>To fix a material (usually solid or human) in the desired location. <i>Example:</i> Shaft bore secures the shaft to enable import and transfer of the mechanical energy.</p>		<p>OF_Type = M In_Type = M, n = 1 Out_Type = M (=In), n = 1</p>
		<p>SEC M2</p> <p>To actively fix or hold material on the desired location. The enabling energy is needed for continuous securing. <i>Example:</i> Robotic hand secures the object.</p>		<p>OF_Type = M In_Type = M, n = 1 Out_Type = M (=In), n = 1 En_Type = E, n = 1 Aux_Type = E (=In), n = 1</p>
	Position	<p>POS M1</p> <p>To place material (usually solid or human) into desired place or position. <i>Example:</i> Ergonomic handle position human hand.</p>		<p>OF_Type = M In_Type = M, n = 1 Out_Type = M (=In), n = 1</p>
		<p>POS M2</p> <p>To actively place material (usually solid or human) into desired place or position. The enabling energy is needed for positioning. <i>Example:</i> Positioning system orients antenna into proper orientation to operate.</p>		<p>OF_Type = M In_Type = M, n = 1 Out_Type = M (=In), n = 1 En_Type = E, n = 1 Aux_Type = E (=In), n = 1</p>

B.3 Modelling Rules

- Function blocks and environment blocks can only be connected by flows. Function blocks or environment blocks cannot be input or output to each other.



- Flows cannot be input to each other.

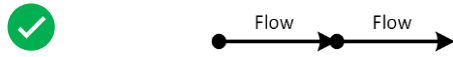

- Flows can have only one tail node and one head node.



- Each flow or carrier/carried flow pair must have an independent environment node for entering and exiting system boundaries.

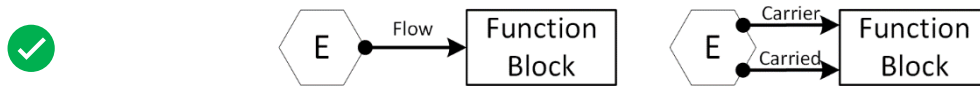

- Carrier-Carried relation of the flows is assumed for all flows that have the same start and end function.

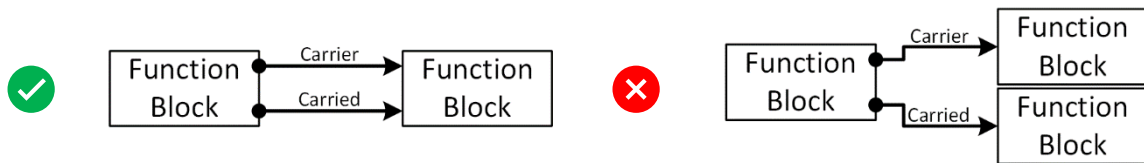

- Flows can be in carrier/carried relation through entire system.

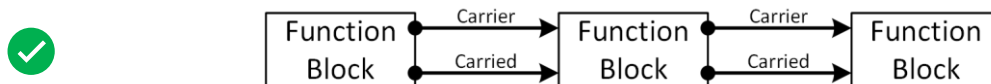

- Flows can be separated from carrier/carried relation only on designated functions (Import, Transfer, Convert).

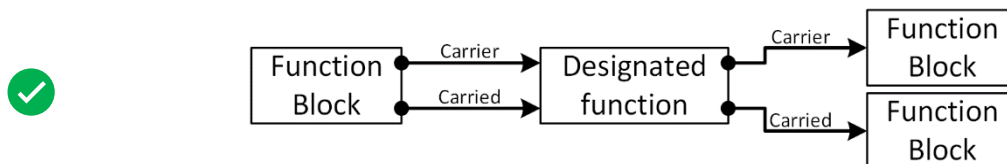

- Flows can be joined in carrier/carried relation only on designated function blocks (Transfer, Convert).

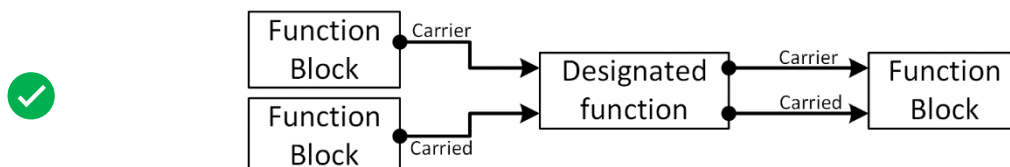

9. Flow chain must start with the function Import and finish with function Export.

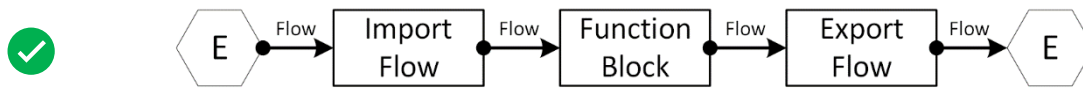

10. Function chain made of only functions Import and Export is not a valid function chain.



11. When possible, flow chains independency should be prioritised.

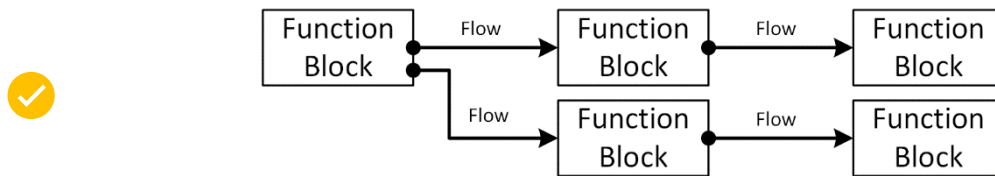
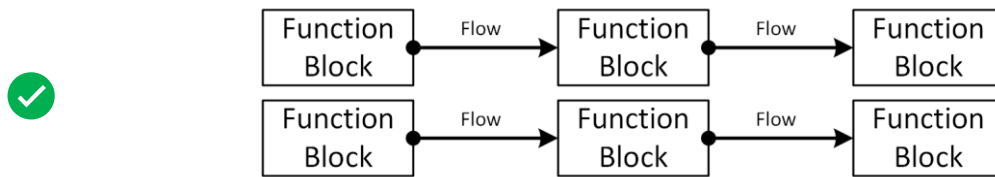

12. Loops in function chains should be avoided.

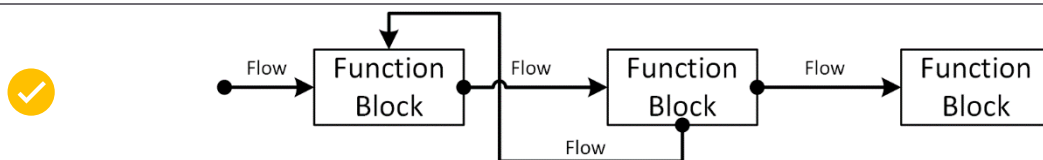
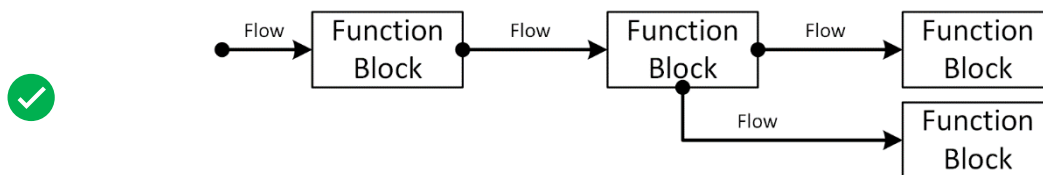

Appendix C

AM Design Principles

This appendix is based on journal paper [161].

#	Design Principles for AM
#DP1	Fit user by using custom ergonomic geometry AM enables manufacturing of complex and curved geometry. Furthermore, each product manufactured with AM can have different geometry. Therefore, the geometry in interaction with the user can be easily customised for an individual user or different groups of users to provide an optimum ergonomic.
#DP2	Absorb energy by using lattice structures AM enables easy manufacturing of lattice structures, on multiple levels of hierarchy, through the entire geometry or only in part of the geometry. The lattice structure can absorb energy through elastic or plastic movement, deformation, or breakage.
#DP3	Absorb energy by using elastic material AM can process a variety of materials with different material properties. Create structures using a material with adequate elasticity to absorb energy.
#DP4	Enhance interaction with environment by customising surface texture With AM, it is relatively easy to manufacture different patterns and textures embedded in the surface of the product. Create customised textures to ensure good grip and interaction with the environment.
#DP5	Enhance interaction with environment by using customised surface features With AM, it relatively easy to manufacture small 3D features on the surface of the products. Create custom features to provide an adequate interaction with the environment.
#DP6	Enable interaction with environment by integrating standard geometry AM can be used to create simple shapes, replicate existing geometry, and integrate multiple features in a single design. Utilise this possibility of AM and integrate a standard geometry (e.g., threads, bores) into a design to enable interaction with the environment and connection with other products.
#DP7	Enable interaction with environment by using custom geometry to fit the use case AM enables easy customisation of geometry. Customise geometry for the particular use case to enable interaction with the environment and direct fit with the geometry of other components.
#DP8	Enhance fluid performance by using customised surfaces AM can manufacture complex shapes. Use this possibility of AM when interacting with fluids to create surfaces whose shape will be in accordance with fluid dynamics to increase the overall performance.
#DP9	Enhance fluid performance by using integrated internal channels AM enables the creation of complex internal geometry. Use the custom internal channels whose shape will be in accordance with fluid dynamics for guiding and distributing fluids to increase the overall performance.

	Enhance material/energy conversion by shaping internal chamber for the use case
#DP10	AM enables the creation of complex internal geometry. Create custom internal chambers with geometry that will be adjusted for a particular physical process happening inside the chamber, such as energy or material conversion.
	Enhance energy magnitude by shaping internal chamber for the use case
#DP11	AM enables the creation of complex internal geometry. Create custom internal chambers with geometry that will help change the magnitude of the energy (e.g., increase/decrease pressure, change acoustic or kinetic energy).
	Conduct mechanical energy and forces by applying lattice structures
#DP12	AM enables easy manufacturing of lattice structures, on multiple levels of hierarchy, through the entire geometry or only in part of the geometry. Use the lattice structures to conduct mechanical energy through the product and create a lightweight but stiff product.
	Conduct mechanical energy and forces by applying topologically optimised geometry
#DP13	AM enables manufacturing of complex geometries. Use this possibility to create topologically optimised geometry to create optimised designs with reduced mass and/or increased performance that will conduct mechanical energy or forces.
	Conduct mechanical energy and forces by using void structures
#DP14	AM enables manufacturing of complex geometries. Use this possibility to create void structures to conduct mechanical energy or forces with reduced weight.
	Conduct energy by using material with appropriate properties
#DP15	AM processes can utilise a variety of different materials. Use appropriate material for the use case.
	Interact with object or material by customising geometry for the use case
#DP16	AM enables easy customisation of geometry. Customise geometry for the particular use case to enable interaction with the object of interest to ensure an adequate fit.
	Import/export fluid by applying appropriate openings
#DP17	With AM, it is easy to create custom openings on the surface. Customise the openings according to fluid dynamics to increase the overall performance during import or export of fluids from the system.
	Conduct energy by embracing anisotropy and layered structure
#DP18	One of the characteristics of most AM processes is the anisotropic properties in a final product. Utilise the product orientation a layer like structure to increase the strength of the part in the direction of energy flow.
	Enable movement of the system by using compliant mechanism
#DP19	Compliant mechanisms enable desired motions through relative flexibility of the mechanism shape. The AM capability of manufacturing complex shapes with varying wall thickness provides a means to create custom 2D and 3D single-body compliant mechanisms.

	Achieve degree of freedom/desired behaviour by applying custom material distribution
#DP20	AM enables manufacturing of shapes with varying wall thicknesses. Use the material distribution to achieve movement and desired behaviour with the relative movement of a single body part.

	Solve function with non-AM component by using integrated attachment point/geometry
#DP21	Sometimes AM cannot solve the product function, or the function can be solved more easily or cheaply with a non-AM component. Use the customisability of AM to create an attachment point or geometry for easy integration of non-AM components into a product.

	Detect and indicate temperature change by using thermal sensitive material
#DP22	AM can process a variety of materials, including thermal sensitive polymers. Use thermal sensitive polymer to indicate a change in temperature to the user without the need for a dedicated sensor.

	Connect another part or flexible end of a part by using integrated attachment point/geometry
#DP23	When a multi-part design or part opening is needed to solve the function, integrate the attachments into a product to ease the assembly and disassembly without the need for additional fastening elements.

	Allow pass through of fluid by using lattice structures
#DP24	AM enables easy manufacturing of lattice structures on multiple levels of hierarchy, through the entire geometry or only in part of the geometry. Use the lattice structures to allow the pass through of fluid over a larger surface area.

	Convey information with colour by using multicolour AM
#DP25	Some AM processes are capable of building multi-material structures. Use the multi-material capability to embed and convey information through colour.

	Convey information by customising geometry
#DP26	AM enables easy manufacturing of complex geometry on multiple levels of hierarchy. Use custom geometry to convey information to the user by embedding it directly to the part.

	Convey information and/or change permutability of light by applying custom material distribution
#DP27	In AM, there is no need for uniform wall thickness. Use material distribution to control permutability of light to embed the information that will be conveyed to the user when the part will be in front of the light source.

	Conduct light by using transparent material
#DP28	AM can process a variety of materials, including transparent and semi-transparent materials. Use transparent materials to conduct and distribute light customised for the use case.

	Store energy by using material elasticity
#DP29	With AM, it is possible to create custom structures that will act as a spring due to their shape and elasticity. Use such structures to store mechanical energy.

Provide movement by using single build assemblies
#DP30 AM can build entire assemblies in a single build without the need for additional assembly operations. Use these capabilities to connect multiple parts and enable movement of the product.

Change motion or force by using single build mechanisms
#DP31 AM can build entire mechanisms in a single build without the need for additional assembly operations. Use these capabilities to create entire mechanisms in a single build that will control the motion or change the force/energy in a predetermined manner.

Achieve desired behaviour by using multi-material AM
#DP32 Some AM processes are capable of building multi-material structures. Use the multi-material capability to design different properties in different areas of the part to achieve desired behaviour (e.g., flexible area vs. stiff area to achieve controlled flexibility of the part)

Appendix D

Mapping Rules

D.1 Function blocks mapping rules

Code	Name of the mapping rule	Possible mappings with DP
Textual Definition		
Graphical Definition		
BR-CH1	Transfer of ME onto Surface	#DP4, #DP5, #DP7
<p>Block of functions used for transferring mechanical energy onto the surface to ensure grip and transfer of reaction forces. It consists of functions <i>Import Surface</i> (IMP M1), <i>Transfer ME</i> (TRA E1) and <i>Export Surface</i> (EXP M2).</p>		
BR-CH2	Transfer of TE on Fluid	#DP9, #DP24
<p>Block of functions used for cooling capability of the system. It consists of functions <i>Guide</i> (GUI M1) and/or <i>Distribute</i> (DIS M1) that operate on the flow of <i>Liquid</i> or <i>Gas</i>, and function <i>Transfer TE</i> (TRA E1).</p>		
BR-CH3	Transfer of TE on Gas	#DP17, #DP24
<p>Function chain used for cooling capability of the system using gas (air). It consists of functions <i>Import Gas</i> (IMP M1), <i>Transfer TE</i> (TRA E1) and <i>Export Gas</i> (EXP M2). The possible additional function is <i>Distribute Gas</i> (DIS M1).</p>		
BR-CH4	Transfer of TE from Liquid	#DP24
<p>Block of functions used to extract thermal energy from the liquid (usually in a heat exchanger). It consists of functions <i>Distribute Liquid</i> and <i>Transfer TE</i> (TRA E3).</p>		

BR-CH5 | **Transfer of Energy on Solid** | **#DP6, #DP7**

Block of functions used for importing and transferring energy (usually mechanical or thermal energy) on solid. It consists of function *Import Solid* (IMP M1), *Position Solid* (POS M2), *Transfer Energy* (TRA E1 or TRA E2), and *Export Solid* (EXP M2)

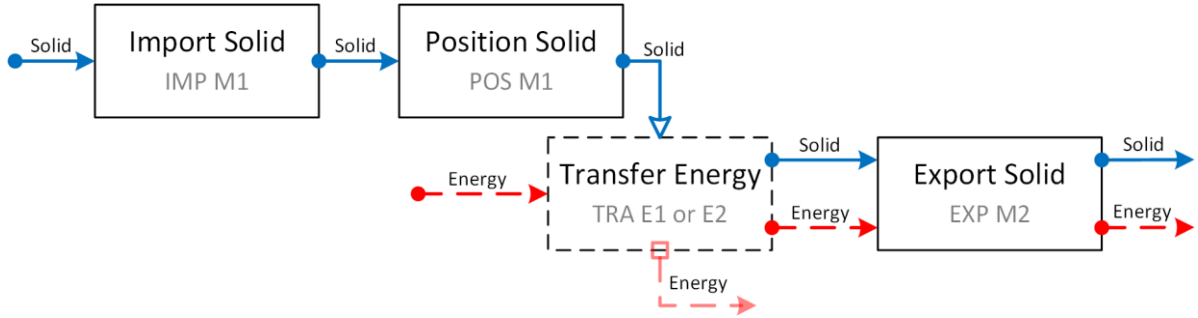

BR-CH6 | **Operating flow of Gas with ME** | **#DP9**

Function chain that operates on the flow of moving gas (gas with mechanical energy). Function chain includes *Import Gas* (IMP M2), *Guide Gas* (GUI M3), and *Export Gas* (EXP M1 or EXP M2). It can also include the function *Transfer ME* (TRA E3) when the mechanical energy from the flow is extracted.

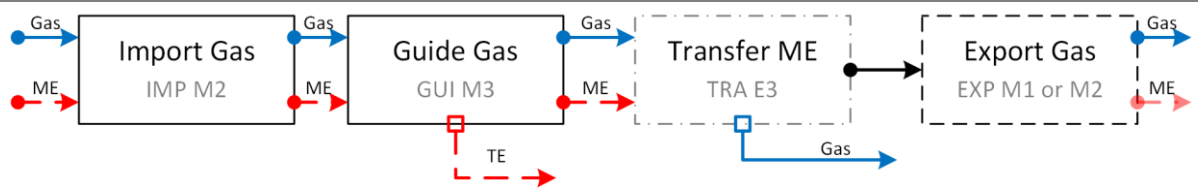

BR-CH7 | **Active movement of the system** | **#DP19, #DP20, #DP23, #DP30, #DP32, #DP20 + #DP32**

Block of functions used to perform an action that includes movement of the system. It consists of function *Allow DOF* (ALL E1) and an active function, *Import* (M4), or *Position* (POS M2), or *Secure* (SEC M2), or *Separate* (SEP M1), or *Export* (EXP M3) Solid. The possible additional function is *Distribute ME* (DIS E2).

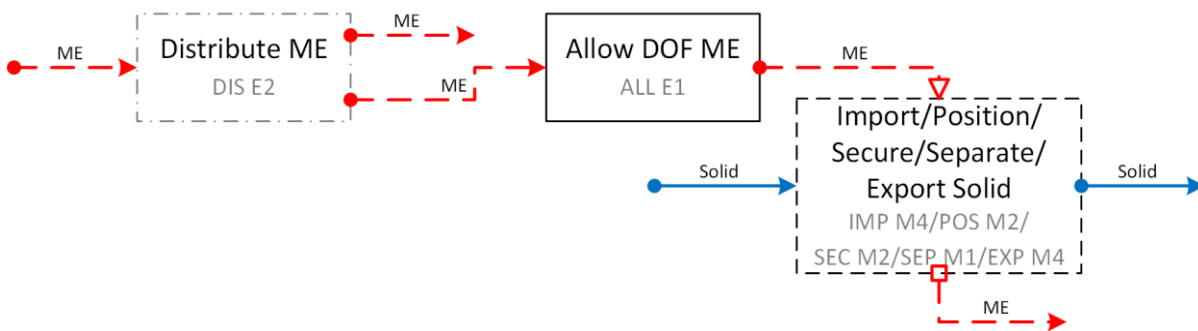

BR-CH8 | **Reactive movement of the system** | **#DP20, #DP23**

Block of functions for reactive movement of the system. Used in combination with BR-CH7 Rule. It is made of functions *Allow DOF* (ALL E1) and *Export ME* (EXP E1). Must use the same principle as BR-CH7.

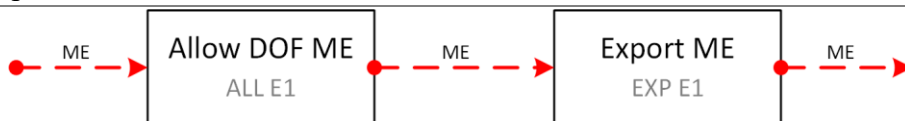

BR-CH9	Movement of the system with change of ME magnitude	#DP19, #DP31
---------------	---	---------------------

Block of functions used to perform an action that includes movement of the system with the change of mechanical energy (force). It consists of function *Allow DOF*, *Change ME* (CHA E1) and an active function, *Position* (POS M2) or *Separate* (SEP M1) Solid. The possible additional function is *Distribute ME* (DIS E2).

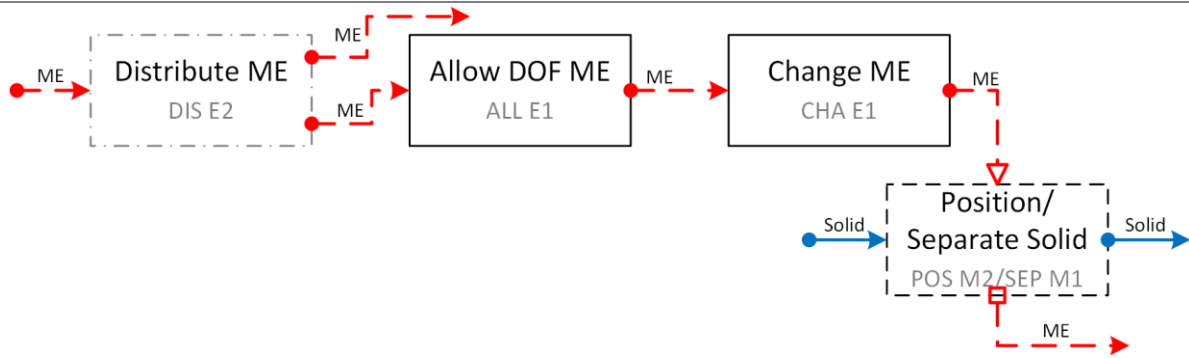

BR-CM1	Control magnitude of mechanical energy	#DP2, #DP3, #DP2 + #DP3
---------------	---	--------------------------------

Block of functions used for control of mechanical energy during impact or high loads. It consists of functions *Change ME* (CHA E1) and *Distribute ME* (DIS E1).



BR-CM2	Deflect impact	#DP7
---------------	-----------------------	-------------

Block of functions for stopping solid with mechanical energy to take over the mechanical energy of impact. It is made of function *Import Solid* (M2), *Stop Solid* (STP M1) and *Export Solid* (EXP M1).

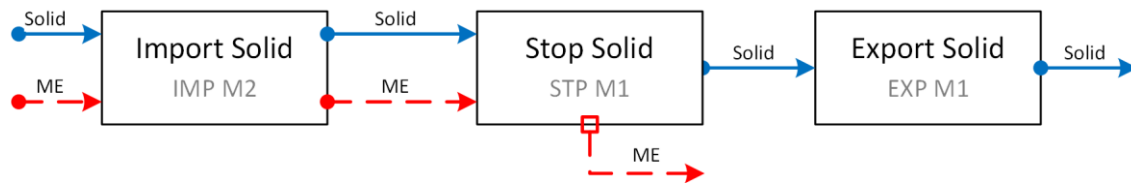

BR-CN1	Passive mixing of material	#DP24
---------------	-----------------------------------	--------------

Block of functions used for supplying of liquid and passive mixing of liquid with another material. It is made of functions *Supply Liquid* (SUP M1) and *Mix Material* (MIX M1).

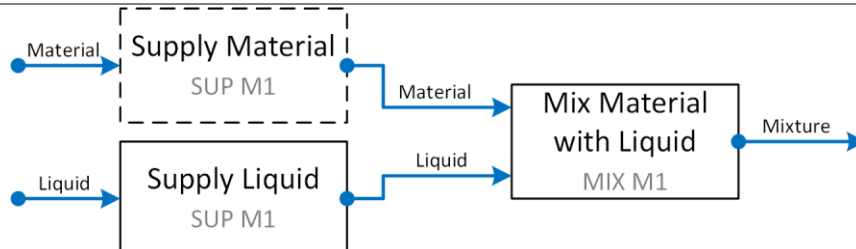

BR-CO1 Conversion of energy and export of Gas #DP10

Block of functions used for conversion of energy from one form to another. After conversion energy is stored in the flow of gas exported outside the system boundaries. It is made of functions *Convert* (CON E2 or CON E3) and *Export Gas* (EXP M2). Possible additional function is *Guide Gas* (GUI M2).



BR-CO2 Conversion and management of fluid flow #DP10

Block of functions used for conversion of material flow into fluid and management of the flow until it exits the system. It is made of function *Convert* (CON M1), *Distribute* (DIS M2) and *Export* (EXP M2). Possible additional function is *Mix Material* (MIX M2).

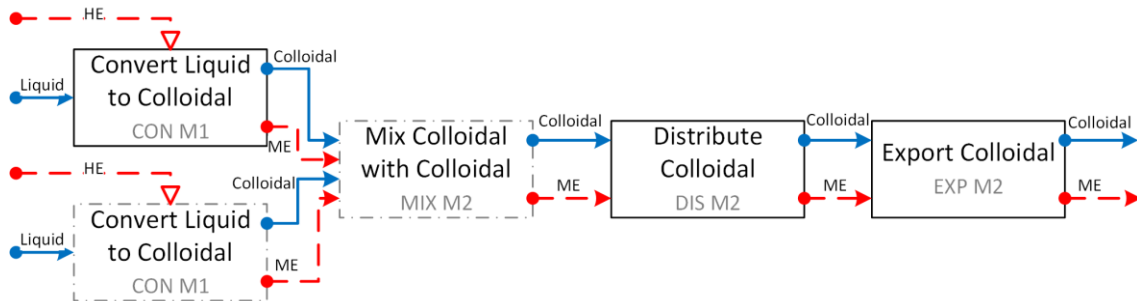

BR-PR1 Store and supply of mechanical energy #DP29, #DP29 + #DP20

Block of two functions for storing and supplying mechanical energy, usually in compression spring like manner. It is made of functions *Store ME* (STO E1) and *Supply ME* (SUP E1).

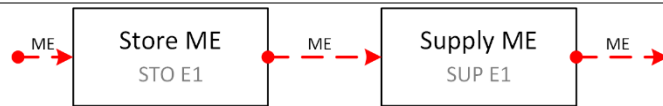

BR-PR2 Store and Supply of Material #DP16

Block of functions for store and supply of material. Function *Store* (STO M1) is combined with functions *Import* (IMP M1), *Supply* (SUP M1) or *Export* (EXP M1).

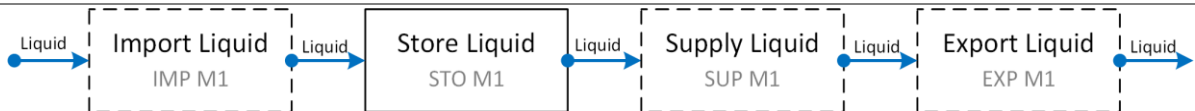

BR-SI1 Detect change of thermal energy #DP22

Block of functions for detecting and showing the change of thermal energy in the system. It is made of function *Sense TE* (SEN E1), *Indicate Status* (IND I1), *Export Status* (EXP I1), and *Export TE* (EXP E1).

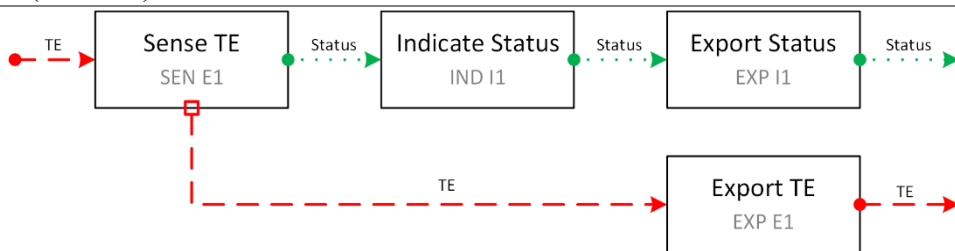

BR-SI2 | **Detect volume of material** | **#DP26**

Block of functions for detecting the volume of material in container. It is made of functions *Sense* (SEN M1), *Indicate Status* (IND I1) and *Export Status* (EXP I1).

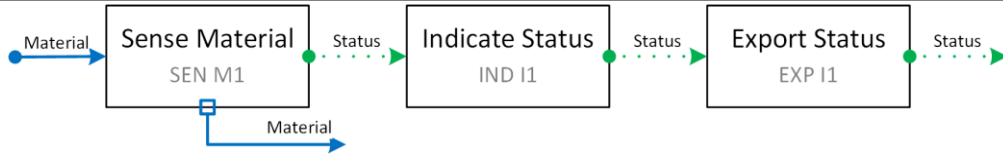

BR-SI3 | **Embed information to the system** | **#DP25, #DP26, #DP25 + #DP26**

Function chain for embedding permanent information into the system. It is made of functions *Import Status* (IMP I1), *Indicate Status* (IND I1), *Export Status* (EXP I1).



BR-SI4 | **Show information with light** | **#DP27**

Block of functions for embedding permanent information into the system that is shown when light pass through it. It is made of functions *Import Status* (IMP I1), *Indicate Status* (IND I2), *Change EME* (CHA E1) and *Export Status* (EXP I1).

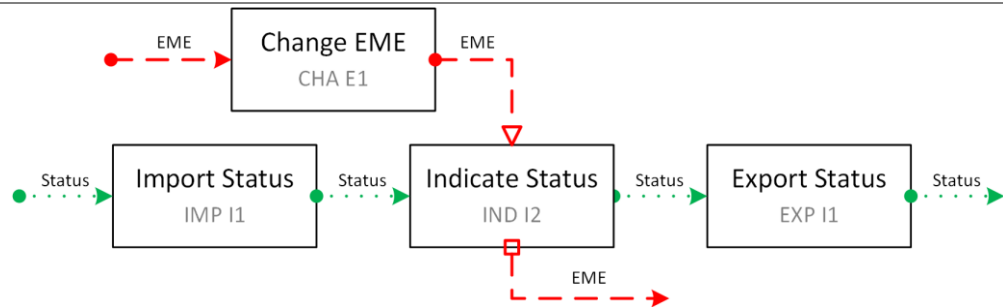

BR-SU1 | **Passive interaction with solid objects** | **#DP6, #DP7, #DP7 + #DP20**

Function chain that enables interaction with the object entering the system, usually for importing energy, transfer of energy onto the object, or for semi-permanent import of object into the system. It is made of functions *Import Solid* (IMP M1 or IMP M3), *Position Solid* (POS M1) and *Export Solid* (EXP M1). Possible additional function is *Secure Solid* (SEC M1).

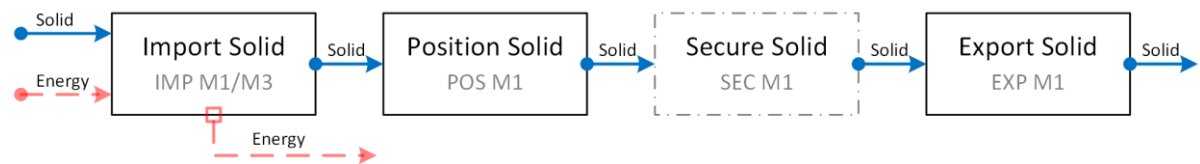

BR-SU2 | **Active interaction with solid or mixture** | **#DP16**



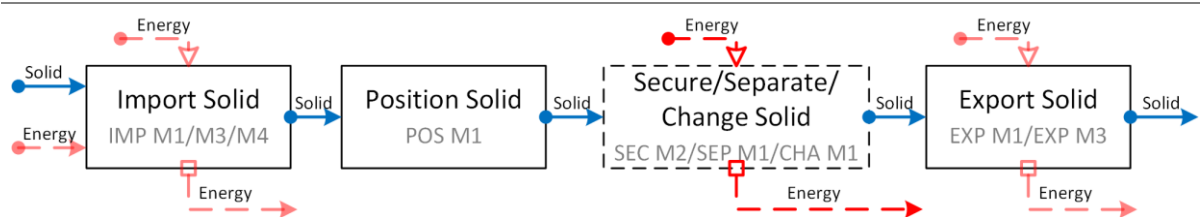

Function chain for active interaction with solid or mixture to perform an action on the flow of solid or mixture, e.g., for separating solid. It is made of active or passive *Import* function (IMP M1, IMP M3 or IMP M4), *Position* (POS M1), active function *Secure* (SEC M2), or *Separate* (SEP M1), or *Change* (CHA M1)) and active or passive *Export* function (EXP E1 or EXP M3) *Solid*. Active functions can be combined with rule BR-CH7 or BR-CH9.





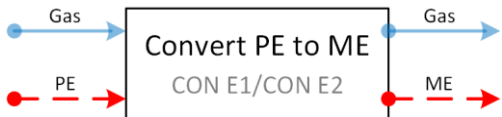
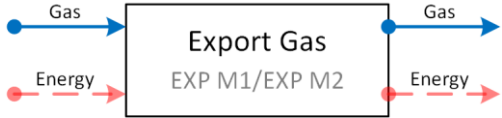

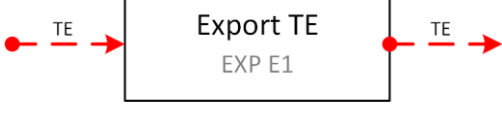

D.2 Flow Mapping Rules

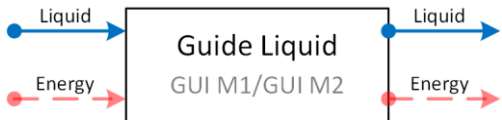
Code	Name of the mapping rule	Possible mappings with DP
Textual Definition		
Graphical Definition		
FR-AE	Management of acoustic energy	#DP11
Function chain for management of a flow of acoustic energy. It is made of all functions operating on the flow of <i>acoustic energy</i> (AE).		
FR-Human	Interaction with the user	#DP1
Function chain for interaction with the user of the system. It is made of all function operating on the flow of <i>Human Material</i> and/or <i>Energy</i> . Function SEC M1 require an additional mapping rule in a double mapping process.		
FR-EME	Conducting light	#DP28
Function chain for management of electromagnetic energy flow (light). All function connected with <i>EME</i> are mapped. Individual functions can have double mapping.		

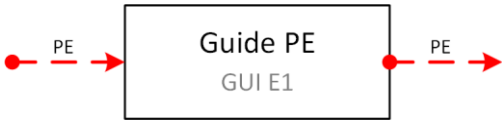
D.3 Individual Function Mapping Rules

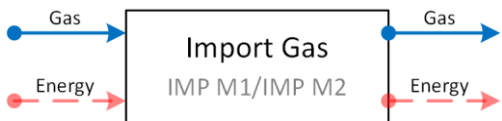
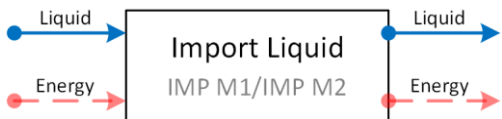
Name	Graphic
Description	
Function(s)	
Possible Mapping	
Change Light	
Function used for changing the permutability of light.	
CHA E1 EME	
#DP27	
	Convert Pneumatic to Mechanical Energy
	Function used for converting pneumatic energy to mechanical energy. Flow of gas can be included.
	CON E1 PE ME, CON E2 PE ME
	#DP10 + #DP20
	Export Gas
	Function used for exporting gas (and the carried energy) from the system.
	EXP M1 Gas, EXP M2 Gas
	#DP6, #DP7, #DP17
	Export Liquid
	Function used for exporting liquid (and the carried energy) from the system.
	EXP M1 Liquid, EXP M2 Liquid
	#DP6, #DP17
	Export Mechanical Energy
	Function used for export of mechanical energy and reaction forces from the system.
	EXP E1 ME
	#DP4, #DP5, #DP6, #DP7
	Export Thermal Energy
	Function used for export of thermal energy from the system.
	EXP E1 TE
	#DP6, #DP7
	Guide Gas
	Function used for guiding gas (and the carried energy) through the system.
	GUI M1 Gas, GUI M2 Gas
	#DP8, #DP9, #DP8 + #DP9
	

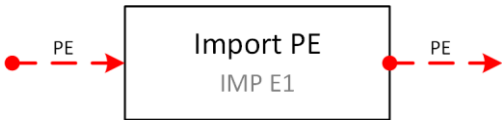
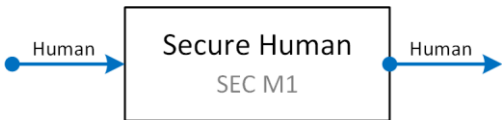
<p>Guide Liquid Function used for guiding liquid (and the carried energy) through the system. GUI M1 Liquid, GUI M2 Liquid #DP9</p>	
<p>Guide Mechanical Energy Function used for guiding mechanical energy through the system. GUI E1 ME #DP12, #DP13, #DP14, #DP14, #DP12+#DP13</p>	
<p>Guide Pneumatic Energy Function used for guiding pneumatic energy through the system. GUI E1 PE #DP9</p>	
<p>Guide Thermal Energy Function used for guiding thermal energy through the system. GUI E1 TE #DP15</p>	
<p>Import Gas Function used for importing gas (and the carried energy) into the system. IMP M1 Gas, IMP M2 Gas #DP6, #DP7, #DP17</p>	
<p>Import Liquid Function used for importing liquid (and the carried energy) into the system. IMP M1 Liquid, IMP M2 Liquid #DP6, #DP17</p>	
<p>Import Mechanical Energy Function used for importing mechanical energy into the system. IMP E1 ME #DP6, #DP7</p>	
<p>Import Pneumatic Energy Function used for importing pneumatic energy into the system. IMP E1 PE #DP7</p>	
<p>Secure Human Function used for firmly holding human in place. SEC M1 Human #DP20, #DP21, #DP23, #DP20 + #DP23</p>	

Appendix E

Case Study 1: AM Gear

The following sections present data gathered in Case Study 1 [185], where mapping methodology is applied to redesign a gear. First collected projected documents are presented. The project documents consist of all function structures, mapped function structures, concepts and prototypes created. For each document, a short description and figure are provided. Next, observation notes are presented, followed by an interview transcript.

E.1 Project documents

E.1.1 GE-PD-01

Function structure of the gear (1st iteration)

Figure E.1 shows the first iteration function structure of the gear using the FC method. The function structure contains 10 function blocks. The two function blocks (*Position Solid* and *Secure Solid*) used in the function structure are not from the developed set of FCs, although they are in accordance with primary rules. The auxiliary flow of energy after function Transfer ME exits the system boundaries directly, violating modelling rule #12. The rest of the function structure elements comply with the FC approach. The overall functionality of the gear expressed through function structure is clear. From top to bottom, the first function chains represent the flow of shaft and ME, and the second represents the gear on which ME is transferred.

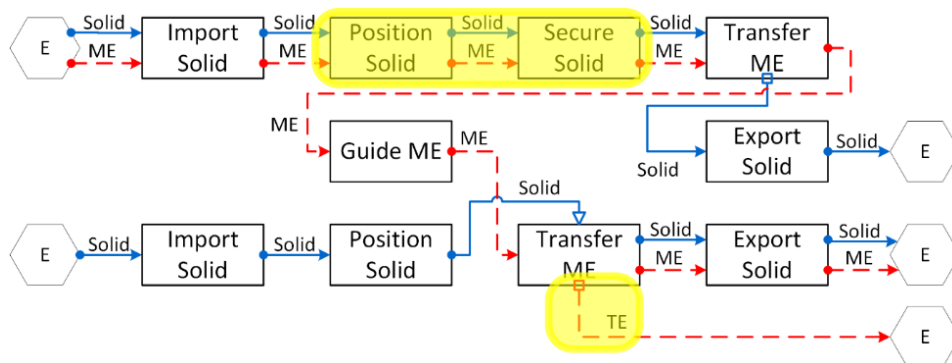

Figure E.1 First function structure of a gear

E.1.2 GE-PD-02

Function structure of the gear with cooling (1st iteration)

Figure E.2 is a first iteration function structure with the added functionality of gear cooling. The function structure contains 7 function blocks. All function blocks are in accordance with FCs and modelling rules. However, the cooling functionality is not modelled in the context of gear but rather as a separate entity. Thus, the designer used the function *Convert ME to TE*, to model the flow of thermal energy. This is not the intended functionality of the gear, but rather *TE* is the auxiliary flow of ME transfer, and the meaning of function structure is not clear. Therefore, the functionality of the gear's cooling expressed through function structure is not entirely clear. From top to bottom, the first function chains represent the flow of liquid for cooling, and the second represents the losses that occur during the transfer of ME.

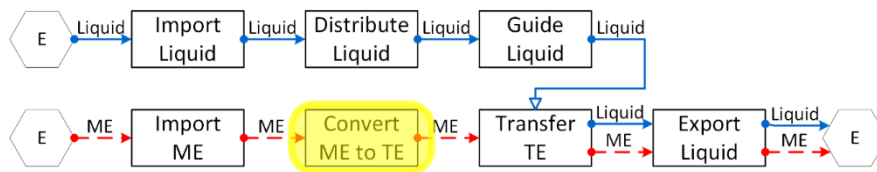

Figure E.2 First function structure of the gear cooling capability

E.1.3 GE-PD-03

Function structure of the gear with liquid cooling

Figure E.3 shows the second and final version of the function structure of the gear with the cooling functionality with liquid. The function structure contains 14 function blocks. All functions and flows are in accordance with FCs and modelling rules. The overall functionality of the gear and its cooling expressed through function structure is clear. From top to bottom, the first function chains represent the flow of the shaft and ME, the second gear on which ME is transferred, and the third represents the cooling using liquid.

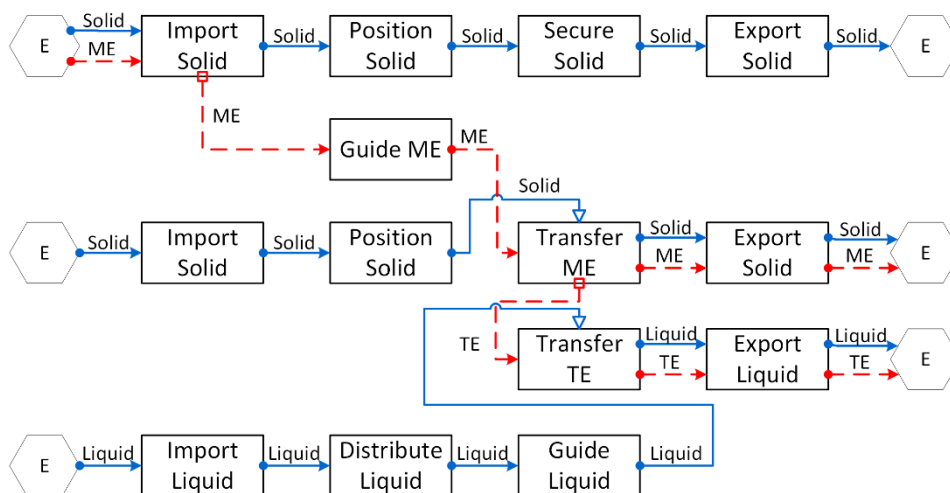

Figure E.3 Final function structure of gear with cooling capability using liquid

E.1.4 GE-PD-04

Function structure of the gear with gas cooling

Figure E.4 shows the second and final version of the function structure of the gear with the cooling functionality through a flow of *Gas*. The function structure contains 13 function blocks. All functions and flows are in accordance with FCs and modelling rules. The overall functionality of the gear and its cooling expressed through function structure is clear. From top to bottom, the first function chains represent the flow of the shaft and ME, the second gear on which ME is transferred, and the third represents the cooling using *Gas*.

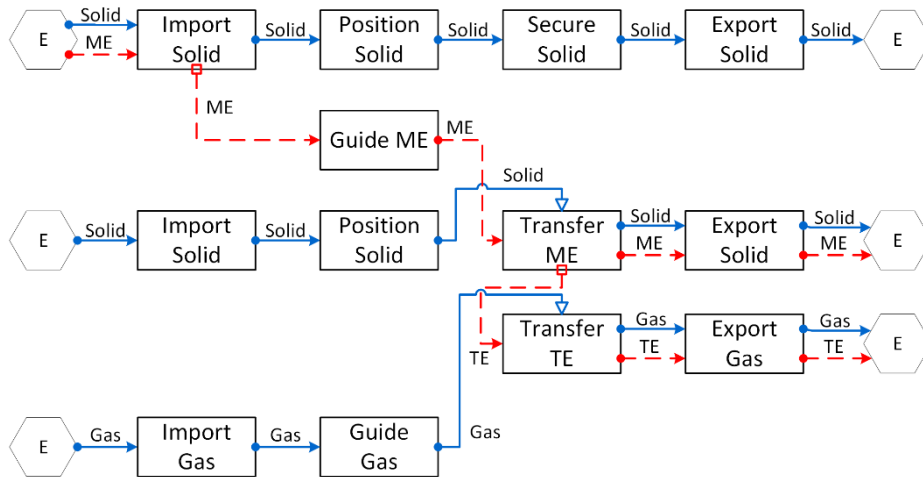

Figure E.4 Final function structure of gear with cooling capability using gas

E.1.5 GE-PD-05

Fully mapped function structure – liquid cooling

Figure E.5 shows all possible mappings on the functions structure of the gear with liquid cooling functionality. The mapping detected 7 possible mappings, of which 5 are unique and 2 have overlaps, where the application of one rule can limit the application of others. In total, 10 different DPs are suggested as possible solutions for mapped functions and function blocks.

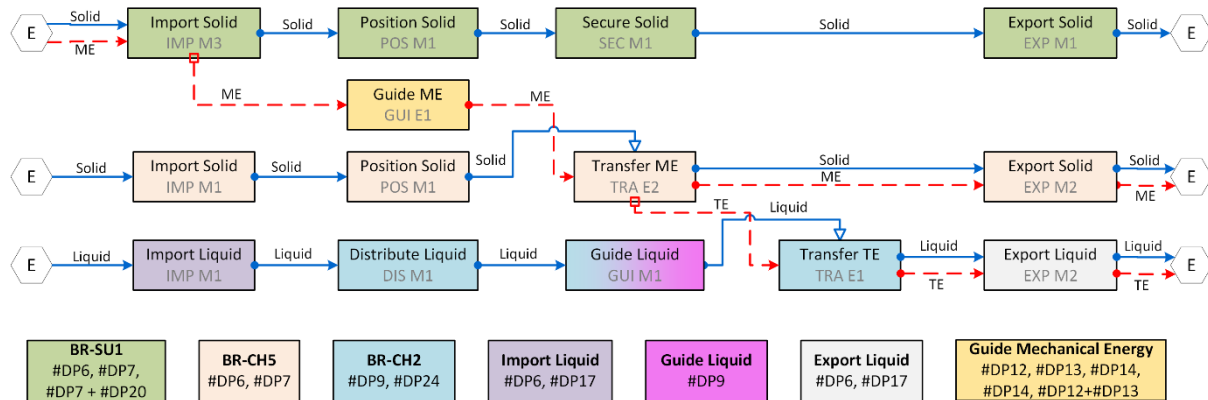

Figure E.5 Possible mappings with AM design principles for function structure with liquid cooling

E.1.6 GE-PD-06

Fully mapped function structure – gas cooling

Figure E.6 shows all possible mappings on function structure of the gear with gas cooling functionality. The mapping detected 8 possible mappings, of which 4 are unique, and 4 have overlaps, where the application of one rule can limit the application of others. In total 11 different design principles were suggested as possible solutions for mapped functions and function blocks.

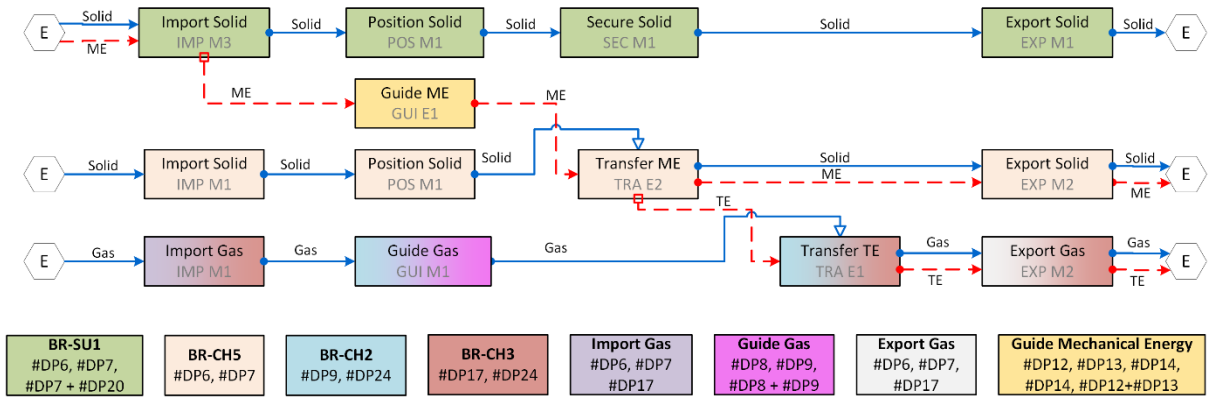

Figure E.6 Possible mappings with AM design principles for function structure with liquid cooling

E.1.7 GE-PD-07

MFP Structure 1

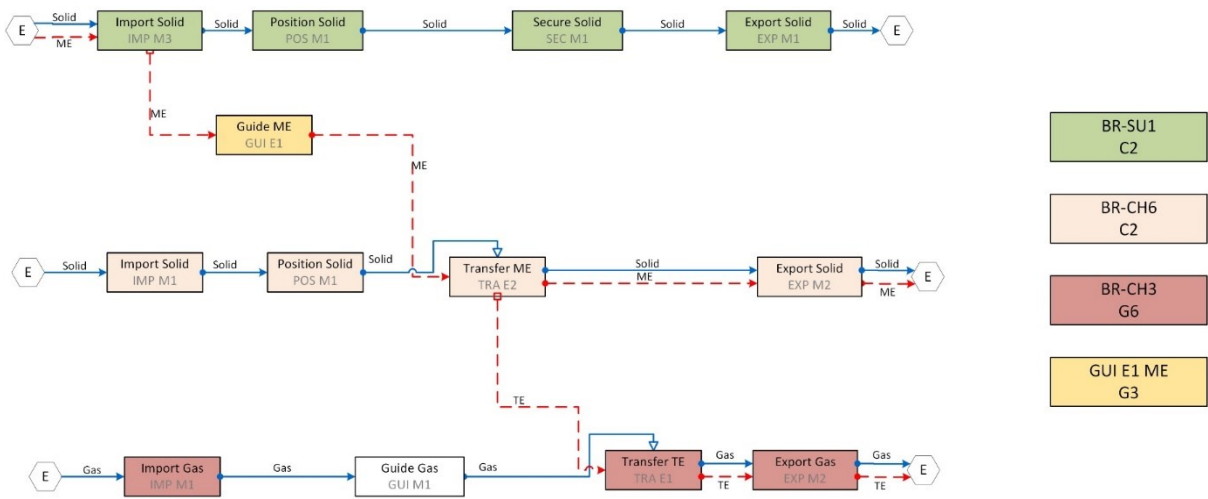
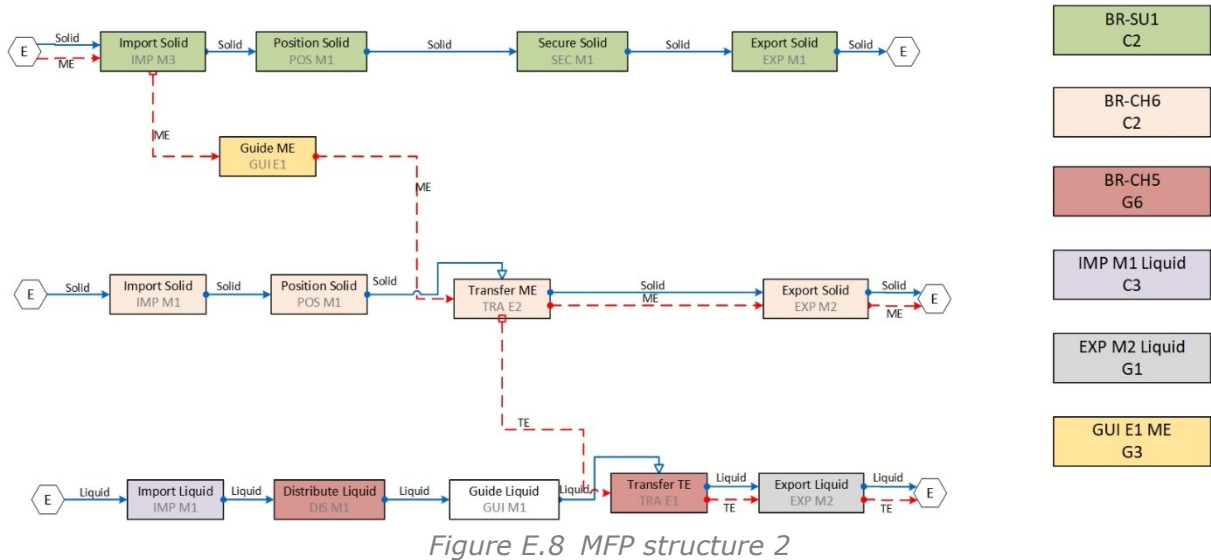

Figure E.7 MFP Structure 1

E.1.8 GE-PD-08

MFP Structure 2



E.1.9 GE-PD-09

MFP Structure 3

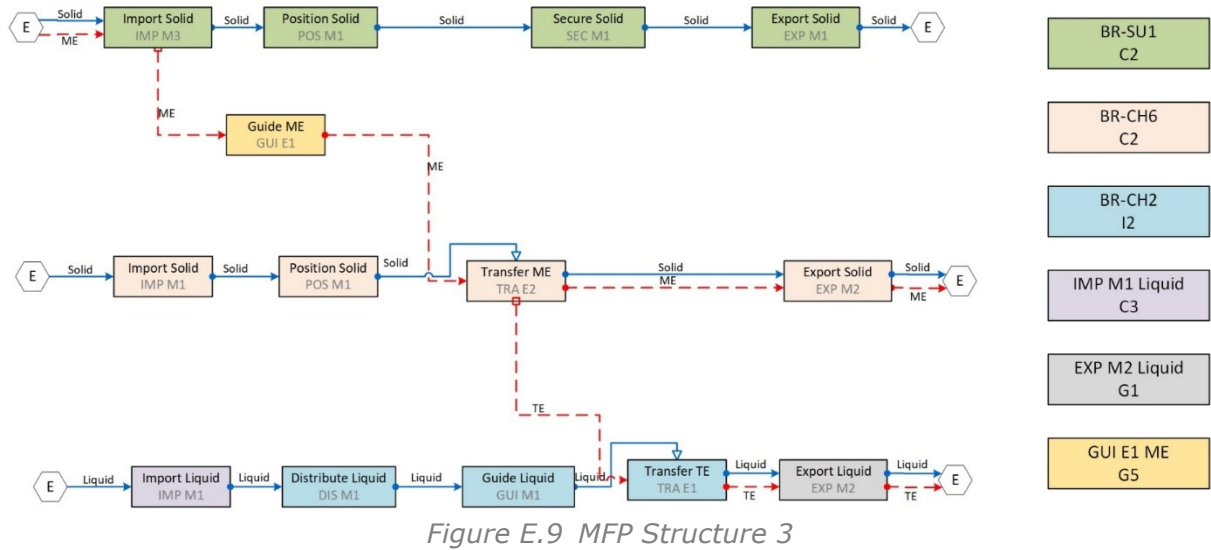

| E.1.10 GE-PD-10

Concept 1

The first concept of AM gear is developed from MFP Structure 1 (Figure E.7). The concept of AM gear (Figure E.10) is based on air cooling. It incorporates a standard geometry profile of gear teeth and the standard geometry of the shaft hub. The gear wheel is connected with a hub through a lattice structure opened from both sides. The lattice structure increases the surface area of the gear, thus enabling better air cooling as more heat can be dissipated.

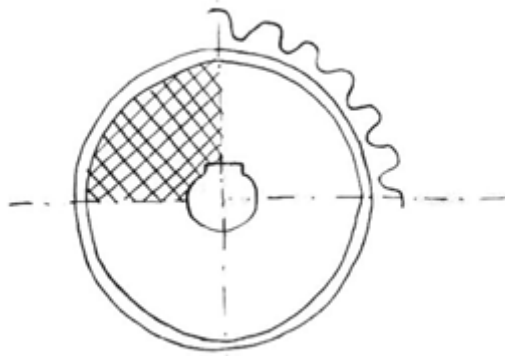

Figure E.10 Concept 1 of AM Gear

| E.1.11 GE-PD-11

Concept 2

The second concept of AM gear is based on mapped function structure 1 (E.1.5). The second concept of AM gear (Figure E.11) uses liquid cooling. It incorporates a standard geometry profile of gear teeth and the standard geometry of the shaft hub. The gear wheel is connected with a hub through a lattice structure. On the rim of the gear are blades whose role is scooping the oil that is then spilled over the lattice structure for cooling.

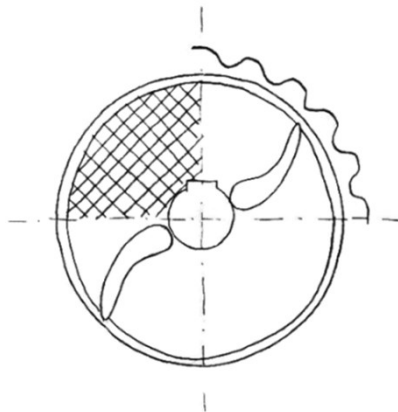

Figure E.11 Concept 2 of AM gear

| E.1.12 GE-PD-12

Concept 3

The third concept of AM gear is based on mapped function structure 1 (E.1.5). The third concept of AM gear (Figure E.12) is liquid-cooled. It incorporates a standard geometry profile of gear teeth and the standard geometry of the shaft hub. The gear wheel is connected with a shaft hub using a void structure. The small internal channels pass through the void structure. Channels' beginning is at the shaft hub, and their ending is on gear teeth. The cooling liquid is supplied through the shaft. Once inside the gear, it cools the gear by passing through internal channels. The exit of cooling channels is on gear teeth to provide lubrication.

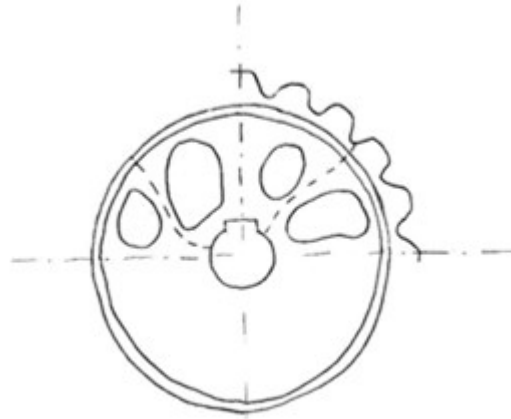

Figure E.12 Concept 4 of AM gear

| E.1.13 GE-PD-13

Concept 4

The fourth concept of AM gear is based on mapped function structure 1 (E.1.5). The fourth concept of AM gear (Figure E.13) is liquid-cooled. It incorporates a standard geometry profile of gear teeth and the standard geometry of the shaft hub. The gear wheel is connected with a shaft hub using a void structure. The gear incorporates several blades with the purpose of gathering coolant. At the bottom of the blade, there is a small opening for the beginning of internal channels that pass through the void structure and are used for cooling. The exit of cooling channels is on gear teeth.



Figure E.13 Concept 4 of AM gear

| E.1.14 GE-PD-14

CAD Model

Figure E.14 shows the CAD model of the AM Gear developed from Concept 4. It embodies #DP6, #DP7, #DP9, #DP15, and #DP17.

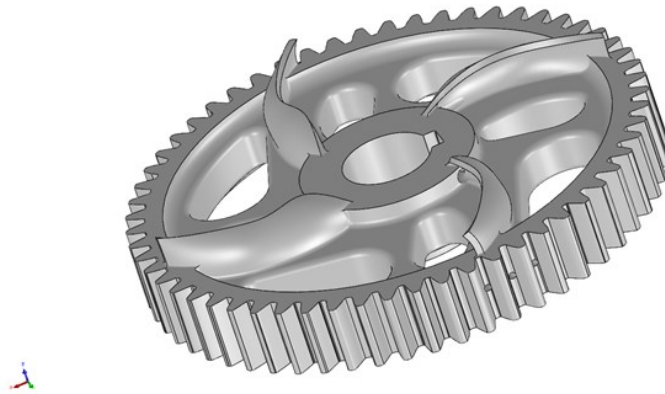

Figure E.14 CAD Model of AM Gear

| E.1.15 GE-PD-15

AM Gear (Physical Models)

Figure E.15 shows the two physical embodiments of the AM gear. The gear on the right is polymer gear made using the FDM process. It is a prototype for the evaluation of the final design. The gear on the left is made of stainless steel using the DMLS process.



Figure E.15 AM Gears

E.2 Observation Notes

E.2.1 GE-ON-01

Project setup observations, October 2021

- Agreement was reached that the topic of the thesis project will be reverse engineering using 3D scanning and DMLS in collaboration with the industrial partner. Furthermore, the possibility of using the mapping methodology was discussed.
- Designer A was given the task of finding an appropriate product for the project. Two options were given, to find a product that needs repairing (e.g., a piece of the product is missing) or a product where the functionality or performance of the product can be improved using AM.
- Four potential products were found: pump housing, servo-motor casing, grinder housing, and gear.
- Through discussion between Designer A and the author, an agreement was reached that the project will be a gear that needs to be redesigned using AM design principles to increase functionality and performance. For the redesign process, the mapping methodology will be used.
- The supervisor and industrial partner approved the topic and project product.

E.2.2 GE-ON-02

Observations of FC learning process, 3rd November 2021

- The concept of function modelling was introduced to Designer A. She had never conducted functional analysis or modelling before. Therefore, a short 45min lecture was given. The lecture explained the logic of function modelling and why it is used in the design process. Furthermore, the list of FCs was shown as a template for creating function blocks, and primary and modelling rules were explained. Five examples of function structure were shown and explained to the designer.
- Before the lecture and the project, the designer didn't see any other function structure, such as function structure with Hirtz's vocabulary or function structure without defined vocabulary.
- The designer has shown an understanding of function modelling, the use of FCs and the shown examples.
- After the introductory lecture on function modelling, two tasks for defining the function of a product were given:
 - o To create a function structure of the gear as it is,
 - o To create a function structure with additional functionalities, e.g., cooling.

E.2.3 GE-ON-03

Observations during function structure review 1, 22nd November 2021

- Designer A submitted two function structures of the gear for the review.
- When asked how she approached the function modelling and whether it was hard to follow the FCs and modelling rules, the Designer responded that she started applying the FCs templates without issues. However, she reported that as there was a lot of new information in the beginning, she required some time to navigate and read all the FCs and rules.
- The first function structure represented the functionality of the gear as it is. The function structure contained 10 functions, 3 input flows and 4 output flows.

- Two mistakes were noted and explained to Designer A in written and oral form.
- The first mistake was the usage of two function blocks with carried energy not prescribed with FCs (*Position Solid, Secure Solid*). Designer A was told to remove the energy flow from the two functions and use function IMP M3 where energy is separated from the carrier upon entry to the function structure.
- The second mistake was the lack of function Export Energy for auxiliary flow that was directly connected to the environment (did not follow Rule #11).
- The second function structure represented the functionality of the cooling. The function structure followed all FCs and modelling rules, but it was modelled without the rest of the gear due to misunderstanding. Designer A was told to merge the second function structure with the first one and think about alternative cooling functionality, for example, with different cooling mediums.

| E.2.4 GE-ON-04

Observations during function structure review 2, 23rd November 2021

- Two reworked function structures are revised. Both have the functionality of cooling, one with liquid and the other with gas as a coolant.
- Function structures do not have any mistakes and comply to the FCs and modelling rules.
- The designer and the author have the same understanding of gear functionality.

| E.2.5 GE-ON-05

Observations during mapping lesson, 30th November 2021

- Mapped function structures with all applicable rules and design principles are presented to the designer. Mapping rules and design principles are explained together with logic and the method of how they are applied. The rules that are applied are thoroughly explained, together with possible mappings of design principles.
- The designer is instructed on how to use mapped function structures, choose the possible solutions, and use them in generating concepts.
- The designer is instructed to create multiple concepts as she sees fit according to the design requirements and using mapped function structures and AM design principles.
- The designer understood the mapping logic and was given all supplementary materials about function mapping and design principles needed for generating concepts.

| E.2.6 GE-ON-06

Observations during concept reviews, December 2021

- The designer created three MFP Structures, one for cooling using gas and two for liquid.
- When asked why there was only one MFP Structure for the gas, the designer stated she only found one combination of DPs that made sense, and she could create a concept from it.
- The designer presented four concepts of the redesigned gear using AM principles. She explained all concepts and reasoning behind the chosen design solutions.
- The concepts utilised two main AM features, void structures and lattice structures and incorporate the cooling capability.

- The designer was given a short lecture on using the concept selection matrix. Criteria for evaluating concepts were discussed.
- The third concept was selected for further development.

| E.2.7 GE-ON-07

Observations during product development, January 2022

- No alterations were made regarding function structure or utilised design principles during product development.
- In an iterative process of designing the AM gear, multiple different embodiments of the same principle were observed. For example:
 - o The cooling channels are embodied in two variants, with a single exit and with multiple exits.
 - o The blades for scooping the coolant were used in the centre and on the outer edge of the gear.

| E.3 Interview Transcript

Interview conducted on 9th March 2022. The interview was conducted in Croatian, and the transcript was translated into English, with minor syntax corrections.

| E.3.1 GE-IN-01

Background information

Interviewer: Did you have any experience with function modelling before this project?

Designer A: *No.*

Interviewer: Did you have any experience with additive manufacturing before this project?

Designer A: *Yes.*

Interviewer: Please describe your previous experience with AM.

Designer A: *I learned about AM during my industrial practice course at Metal Centre Čakovec; before that, I didn't have experience with AM in my courses on faculty.*

Interviewer: What exactly did you do and learn at Metal Centre Čakovec?

Designer A: *I learned about 3D scanning, metal AM and polymer AM.*

Interviewer: Did you only use AM as a manufacturing process, or did you also have designed parts for AM?

Designer A: *Mostly only manufacturing, as we received designs for AM from customers. I only designed one fixator for medical application, but half of the model was from 3D scanning, and the other half was then reconstructed in CAD.*

| E.3.2 GE-IN-02

FC Method

Interviewer: When you think back about the introductory lecture on function modelling using the Function Class approach, what was your impression about the approach? Did you understand the concept of Function Classes and the templates and rules provided during the lecture?

Designer A: *At first, it [the function modelling] was very interesting when I saw it. I didn't even know something like that existed. Rules were clear, especially after the explanation of how to*

think about the product through functions. After I read them on the paper, everything was clear, especially the ones [FC templates] for each function.

Interviewer: What was your experience using the Function Class modelling approach, including templates and rules you received in paper and PDF format? Were the vocabulary, FCs, and rules clear and understandable?

Designer A: *For me, it was useful to have everything on paper, as I usually like to have everything on paper. However, the problem was searching through all the materials. You must go from beginning to end to find something. Then you need something else [another function], and you go from the beginning again and search for this one function.*

Interviewer: And was the content itself clear enough?

Designer A: *Yes, to me, it was clear.*

Interviewer: Now that you redo your function structure using the Function Modelling App, can you compare your process of creating a function structure using paper and the process using the application? What process do you prefer, and why?

Designer A: *[A function modelling process] through the application is easier. You just have to click, and you get an explanation for each function [class]. For example, there are multiple Import functions, and we can click on each and read [their description].*

Interviewer: Please describe your function modelling process from a logical point of view. What was your approach to the function modelling process? Please describe the way you created the function structure and highlight the difficulties you encountered and what you find helpful during function modelling.

Designer A: *First, I thought about all the functions product has. Not one by one, and then writing them down, but rather all [as a group]. After that, I wrote down each of the functions [I thought up] separately and then it was a bit harder to think about how to connect them, the different functions. For example, the function of Importing shaft and [connecting it with] the other gear and the cooling, [question was] with which function to connect these two functionalities, the two function chains, that was the hardest to me. But yes, I first thought about functions, and then I started creating the function structure.*

Interviewer: And in this process, did you use Function Classes templates from the beginning, or did you first define functions using your own vocabulary and then translate them into Function Classes?

Designer A: *No, I used [Function Classes] templates from the beginning.*

| E.3.3 GE-IN-03

Mapping Method

Interviewer: When you think back about the lecture on methodology for mapping product functions with design principles for AM, what was your impression about the approach to finding solutions that way? Did you understand the concept of mapping methodology and the rules provided during the lecture?

Designer A: *Yes [I understood it]. But first, I thought that everything is determined by a particular rule. [I didn't understand] that I have to choose the principles additionality.*

Interviewer: What was your experience using tools for mapping product functions (rules and application)? Were the mapping rules clear and understandable?

Designer A: *Yes, to me, it was clear.*

Interviewer: Were the design principles provided for the mapping process understandable? Were you able to comprehend the meaning of design principles and the meaning of AM possibilities they were referring to?

Designer A: *No. I understood the principles but didn't immediately understand how it is related to AM.*

Interviewer: Can you explain what was the problem? Was something missing from the description, for example, a picture of a principle?

Designer A: *Not really. For example, I had never encountered a void structure before, so I didn't know how that looked. Maybe the picture would be helpful.*

Interviewer: Please describe your process of generating concepts using mapped function structures that were given to you. Could you describe how the mapping function structures influenced your approach to generating concepts? Please highlight the difficulties you encountered and what you find helpful during the concept generation process.

Designer A: *I think I went through the rules one by one and was looking at which principles were suggested. [At the same time] I thought about the compatibility of different principles from different rules, can I connect them to one [design]. For example, in one rule, lattice structure was suggested, and then in another, something different was suggested that does not involve lattice structure. Then you have to combine [different] principles to be integrated into one concept.*

Interviewer: What is your opinion about the solutions the mapping process suggested to you? Did you find the quality and broadness of suggested solutions adequate?

Designer A: *Some are broad enough; others are a bit restrictive when there is only one rule or principle. You don't have too much choice then.*

Interviewer: Do you think the mapping process enabled you to achieve function integration (solving two or more functions with the same technical solution)? Please provide an example if possible.

Designer A: *Yes, for example, holding off the shaft is made of multiple functions, and then it was suggested one rule for all [functions in a function chain]. We have Import Solid, Secure Solid, and it was suggested to use one rule for all. So yes, it was useful.*

Interviewer: If this rule was not suggested, do you think you would try to find a partial solution for each of these functions?

Designer A: *Maybe, as it is on Liquid flow. [Function] Import is separately, Export is separately, and [functions] in between are one, so maybe on that way.*

E.3.4 GE-IN-04

Other information

Interviewer: Do you have any additional comments or thoughts about the entire process of function modelling, mapping, and concept generation? Something that was helpful, something you didn't like, or something you would like to change?

Designer A: *Maybe to have some help or suggestion on how to combine principles. Although that is the job of the one who is generating concepts. But maybe to have a proposition of how different principles in rules can be combined together.*

Interviewer: Now that you tested the application, what is your opinion on using the Function Mapping App in comparison to the use of paper and PDF materials?

Designer A: *It is faster. Function structure is drawn faster, and you can find rules faster when you do the mapping. Because they are already suggested, and you don't have to look paper by*

paper and think about every rule. I especially like that the rules [function class templates] are listed. For example, for import, they are one below the other, and you just have to click, and everything is explained below immediately.

Interviewer: Would you maybe change something in your function structures or mapping now that you have used the application?

Designer A: *Yes, I got a new idea for using some functions, like Store and Supply Liquid.*

Appendix F

Case Study 2: AM Bicycle

The following sections present data gathered in Case Study 2. First collected projected documents are presented. The project documents consist of all function structures, mapped function structures, concepts and prototypes the designer created. The documents are grouped by topic, and for each document, a short description and figure are provided. Next, observation notes are presented, followed by an interview transcript.

Note: The errors in function structures are highlighted. Due to readability, not all errors are highlighted.

F.1 Project documents

F.1.1 BI-PD-01

Function structure of the bicycle

The function structure of the bicycle (first iteration) is made of two parts that are not connected by flows (Figure F.1). The first part starts with the function Import Human (top), and the function in these function chains relates to the functionalities of braking and driving the bicycle. The second part also starts with Import Human (bottom). This function chain relates to the positioning and distribution of drivers' weight. The overall functionality of the bicycle expressed in function structure is not clear.

Function structure contains 25 function blocks, with the majority of blocks following FCs rules. The errors include wrong inputs and output sides of flows (e.g., in Sense ME, main flow exits in place of auxiliary flow) and use of additional words in flow description (Convert ME (rotation) to ME (translation)). The representation of flows does not follow the prescribed graphical representation.

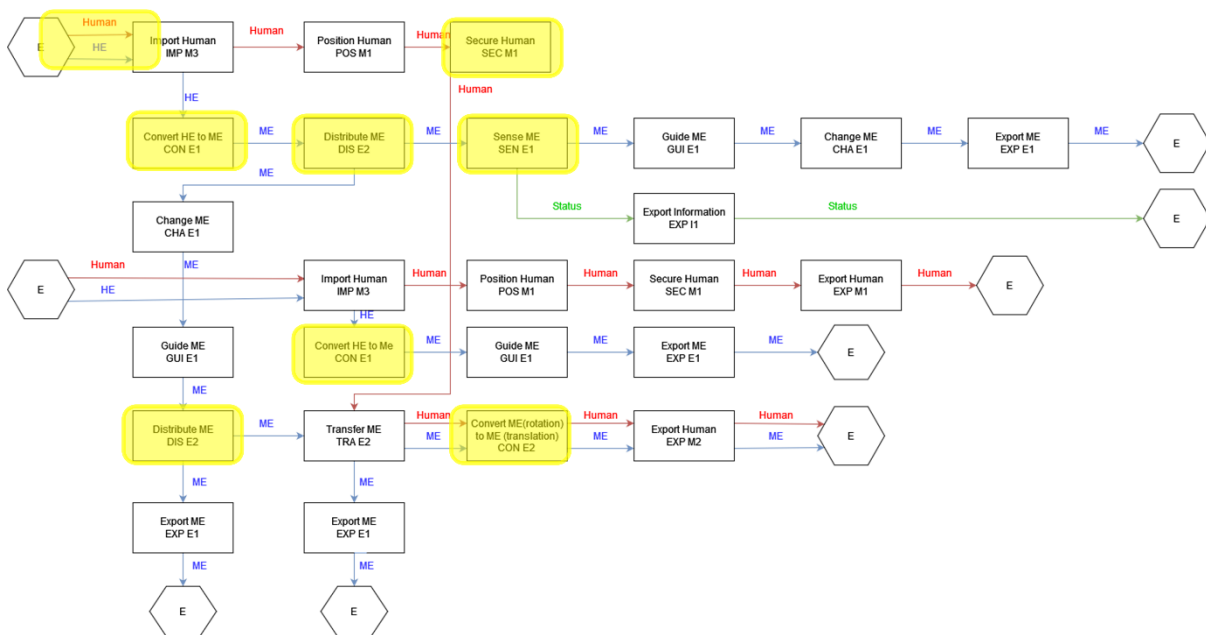

Figure F.1 Function structure of the bicycle (1st iteration)

Most syntax errors are corrected in the final function structure (Figure F.2) of the bicycle. Some functions (e.g., Secure Human) are removed. The designer added additional notations (in

Croatian) to explain the functionality of the bicycle. However, the overall functionality of the bicycle expressed through function structure is not clear.

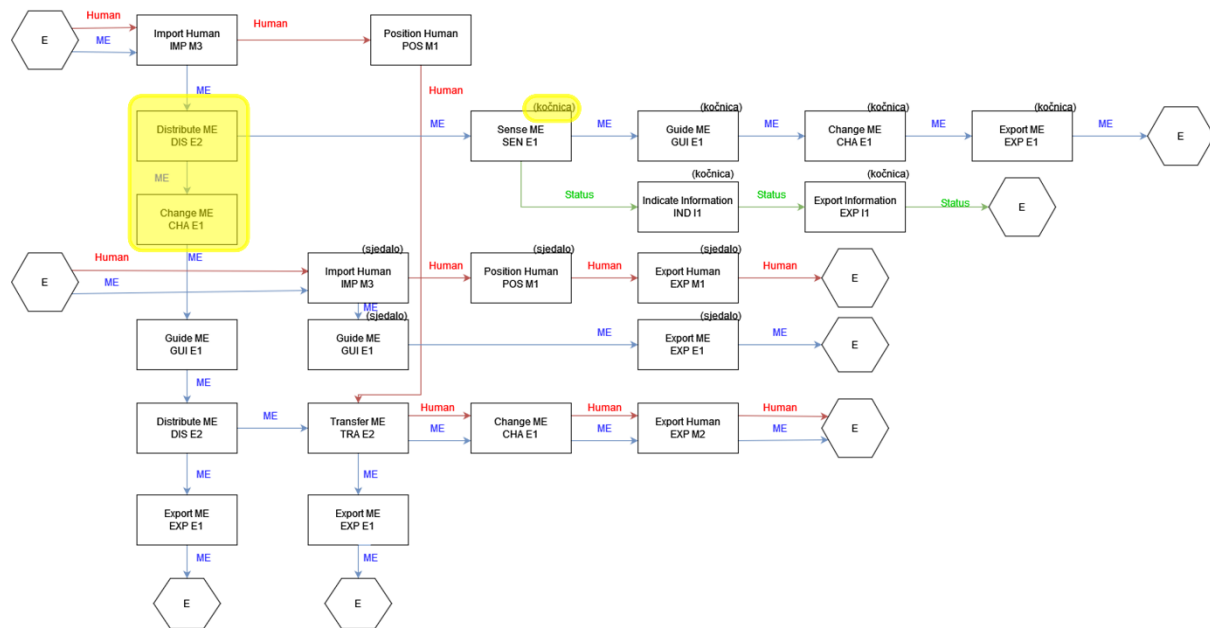

Figure F.2 Function structure of the bicycle

F.1.2 BI-PD-02

Function structure of the wheel

The functionality of the wheel is represented through four functions. The function structure is mostly compliant with the FCs approach. The two errors are the use of terms not defined in the FCs approach and the wrong application of function DIS E2, where auxiliary flow is not exported according to modelling rules. The representation of flows does not follow the prescribed graphical representation. The overall functionality of the wheel expressed through function structure is not clear due to ambiguity about what function CON E1 represents.

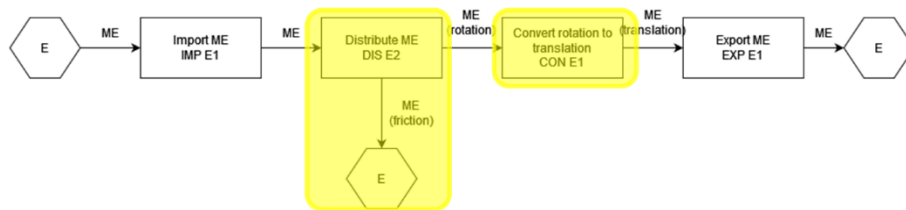

Figure F.3 Function structure of the wheel (1st iteration)

The modified function structure has a function Change ME that represents the absorption of vibrations. The function structure is compliant with FC approach. However, the elements of graphical representation are not followed. The overall functionality of the wheel expressed through function structure is clear.

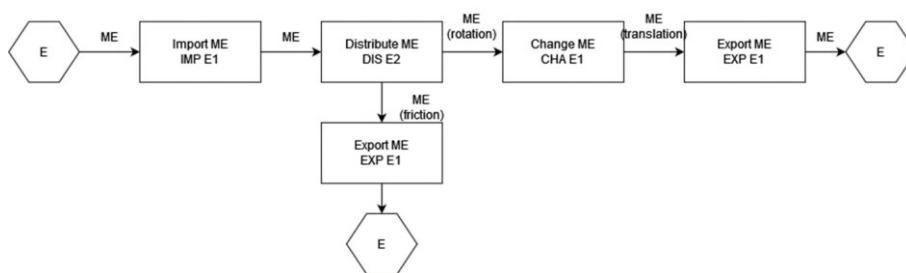

Figure F.4 Function structure of the wheel

F.1.3 BI-PD-03

Function structure of the pedal

The function structure of the pedal is made of 7 function blocks. The function structure is compliant with the FC approach, except Human Energy (HE) entrance into function Convert, as it enters from the top rather than the left side. The representation of flows does not follow the prescribed graphical representation. Nevertheless, the overall functionality of the pedal expressed through function structure is clear. The development of the component stopped with a function structure.

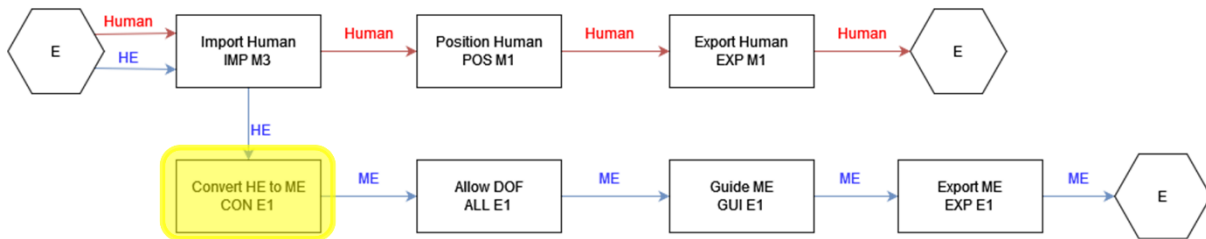

Figure F.5 Function structure of the pedal

F.1.4 BI-PD-04

Function structure of the bicycle frame

The function structure of the bicycle frame is made of 4 function blocks that operate on the flow of ME. The function structure is fully compliant with the FCs approach. The representation of flows does not follow the prescribed graphical representation. However, the overall functionality of the bike frame expressed through function structure is clear.

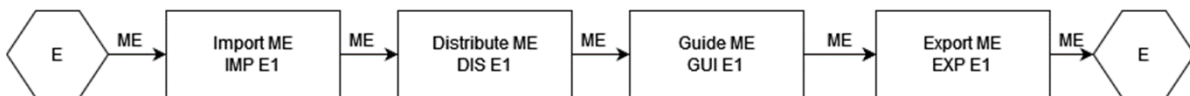

Figure F.6 Function structure of the bicycle frame (1st iteration)

In the second iteration, additional functionalities are incorporated into the function structure. Namely, the embedded visual information and import of objects (e.g., water bottles) are added. The overall functionality of the wheel expressed through function structure is clear, except for the function POS M2 (active positioning) and its role in the structure. This function is replaced with POS M1 (passive positioning) in the final version of the function structure.

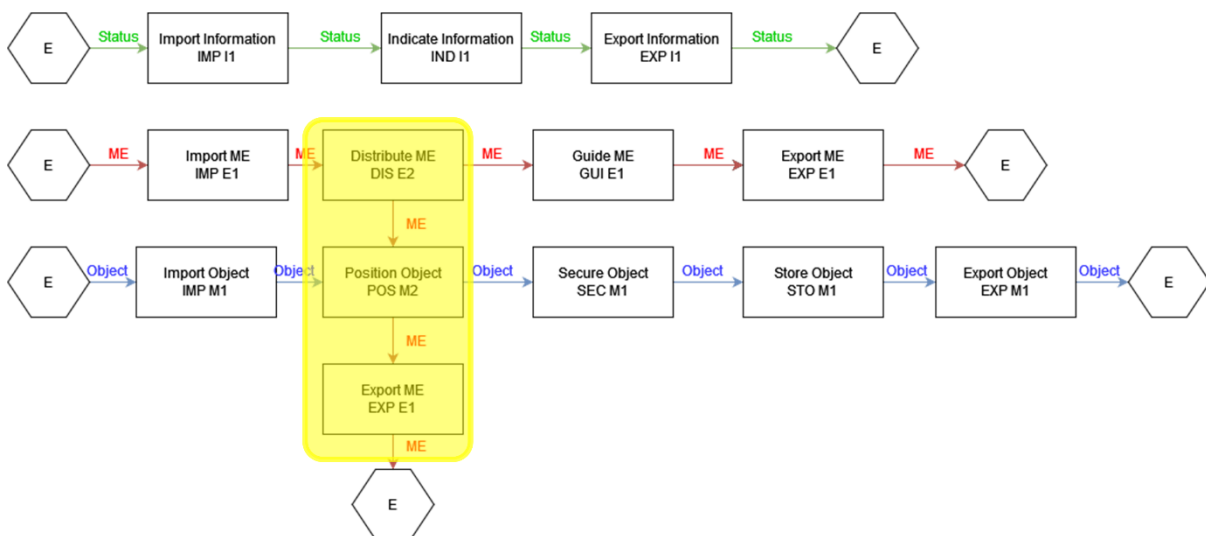

Figure F.7 Function structure of the bicycle frame (2nd iteration)

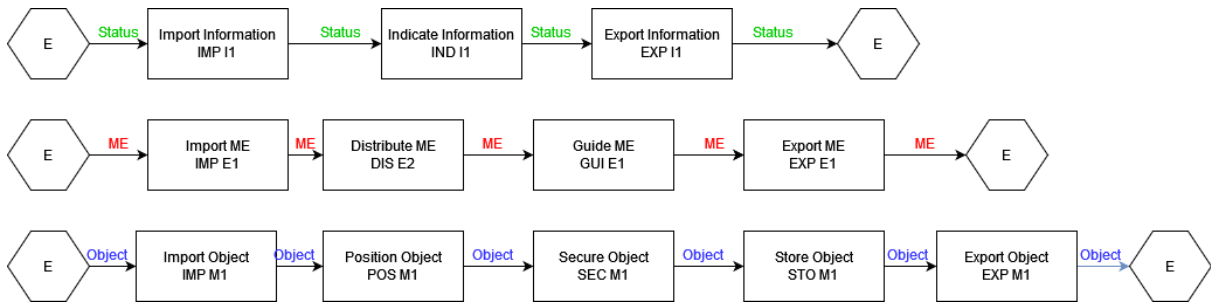

Figure F.8 Function structure of the bicycle frame

F.1.5 BI-PD-05

Function structure of the hand brake lever

The function structure of the hand brake lever is made of 5 function blocks. The function structure is mostly compliant with the FCs approach. An exception are the flows ME and Status exiting the Sense Energy function that should be inverted. The wrong exit of status influences the wrong side of entering function Export Information. Typing error is in functions SEN E1 and EXP E1 where instead of word Energy should be ME. The representation of flows does not follow the prescribed graphical representation. Additional functions such as Indicate Information or Change ME could be added. The overall functionality of the hand brake lever expressed through function structure is clear. The development of the component stopped with a function structure.

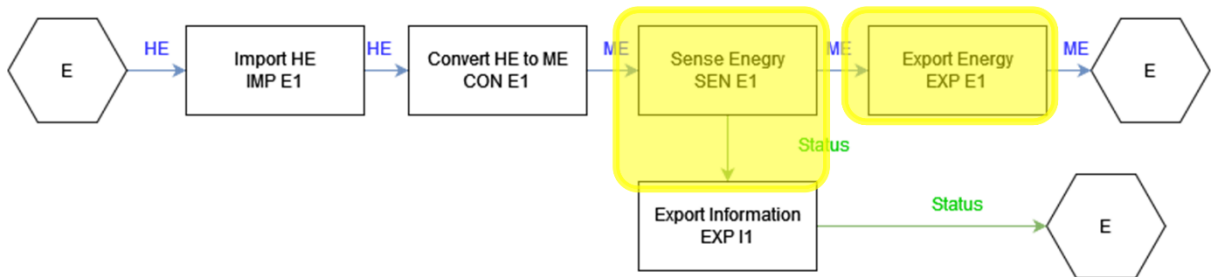

Figure F.9 Function structure of the hand brake lever

F.1.6 BI-PD-06

Function structure of the seat

The function structure of the bike seat is made of 7 function blocks. The function structure is fully compliant with the FCs approach. The representation of flows does not follow the prescribed graphical representation. The overall functionality of the seat expressed through function structure is clear, except for the role of function Secure Human. This function is later removed in a final version of the function structure.

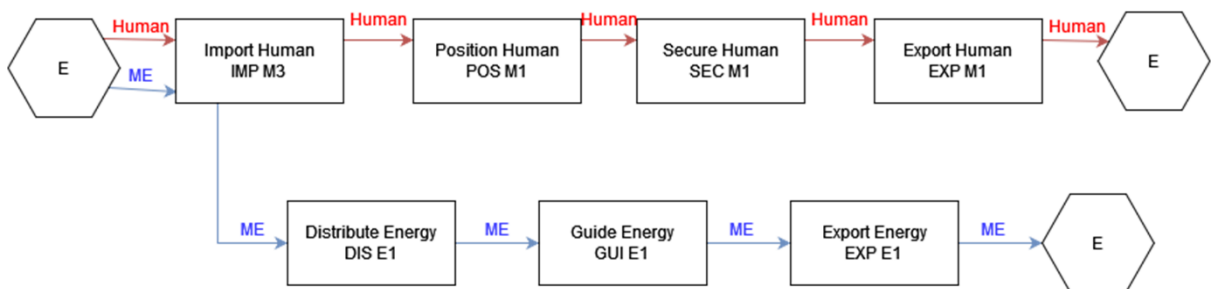

Figure F.10 Function structure of the seat (1st iteration)

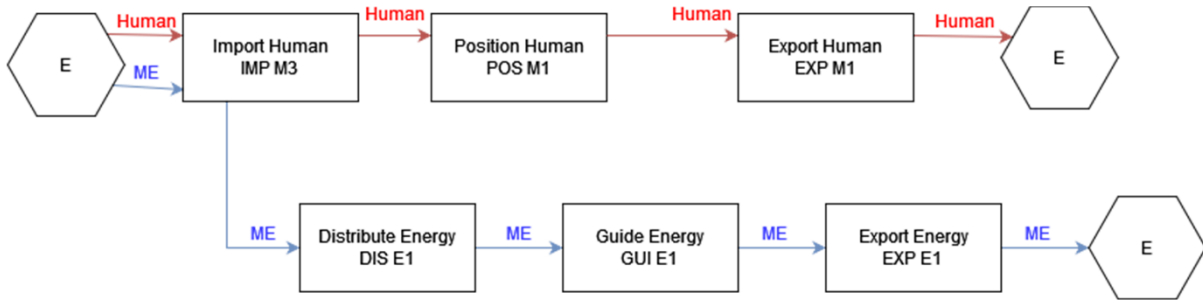

Figure F.11 Function structure of the seat

F.1.7 BI-PD-07

Function structure of the steering wheel

The function structure of the steering wheel is made of 6 function blocks. The function structure is compliant with the FCs approach, except Human Energy (HE) entrance into function Convert, as it enters from the top rather than the left side. The representation of flows does not follow the prescribed graphical representation. The overall functionality of the steering wheel expressed through function structure is clear. In the final version of the function structure, the additional function Allow DOF is added to represent the movement of the steering wheel. The development of the component stopped with a function structure.

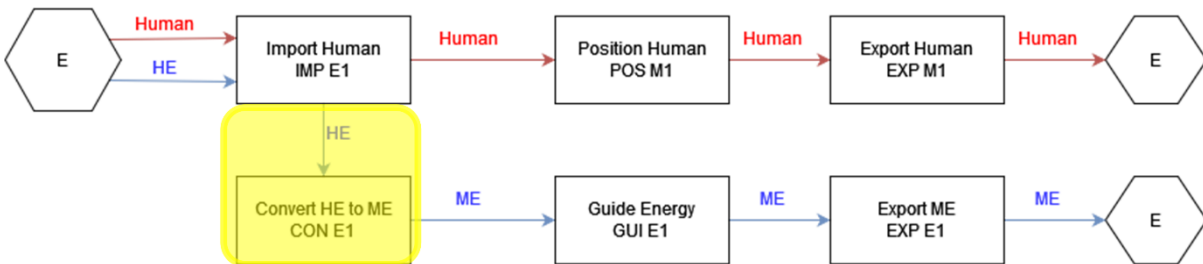

Figure F.12 Function structure of the steering wheel (1st iteration)

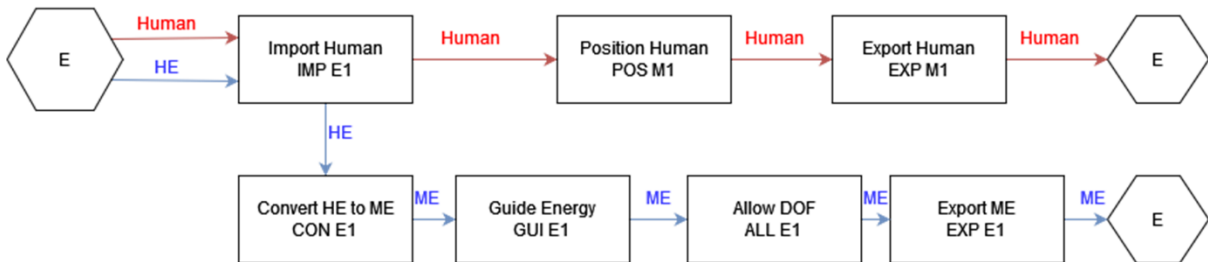

Figure F.13 Function structure of the steering wheel

F.1.8 BI-PD-08

Mapped function structure of the bicycle frame

Figure F.14 shows all possible mappings detected on the function structure of the bicycle frame. The mapping detected 6 possible mappings, and two of them have overlaps in the application. In total, 12 different DPs are suggested as possible solutions for mapped functions and function blocks.

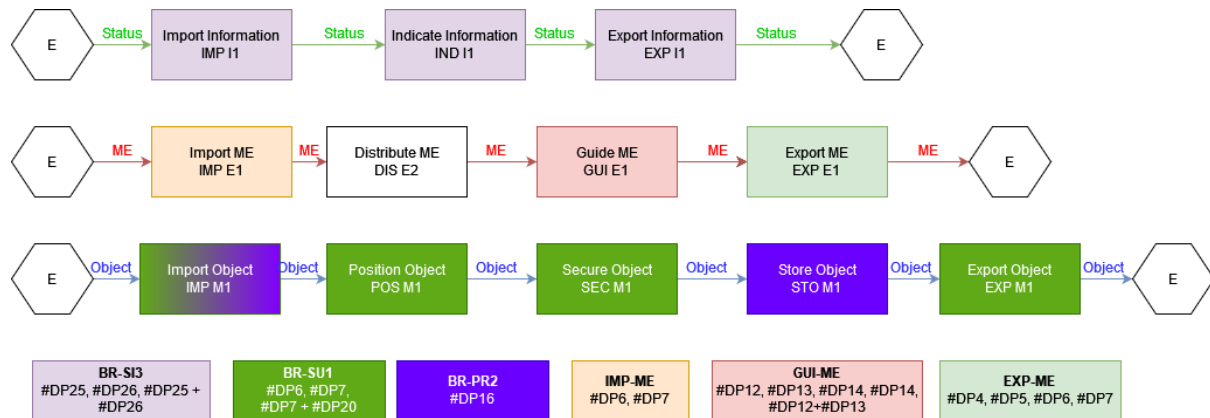

Figure F.14 Mapped function structure of the bicycle frame

F.1.9 BI-PD-09

Mapped function structure of the wheel

Figure F.15 shows all possible mappings detected on the function structure of the wheel. The mapping detected 3 possible mappings. In total, 6 different DPs are suggested as possible solutions for mapped functions and function blocks.

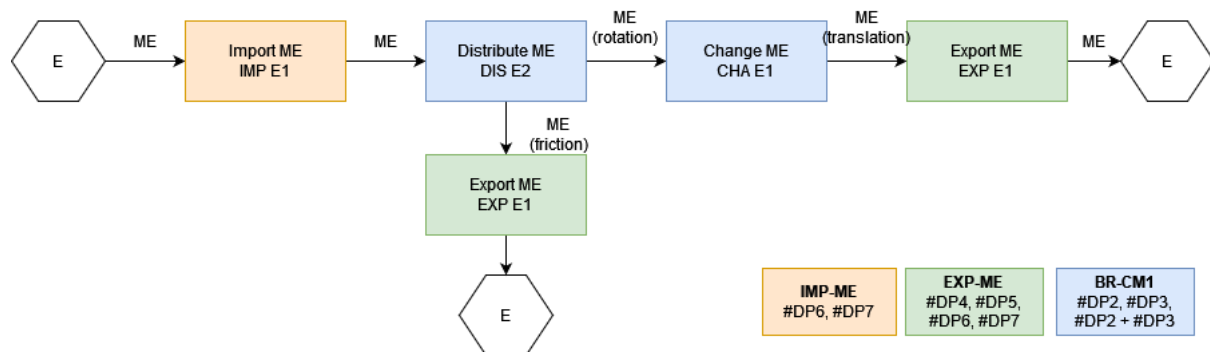

Figure F.15 Mapped function structure of the wheel

F.1.10 BI-PD-10

Mapped function structure of the seat

Figure F.16 shows all possible mappings detected on the function structure of the wheel. The mapping detected 3 possible mappings. In total 9 different DPs are suggested as possible solutions for mapped functions and function blocks.

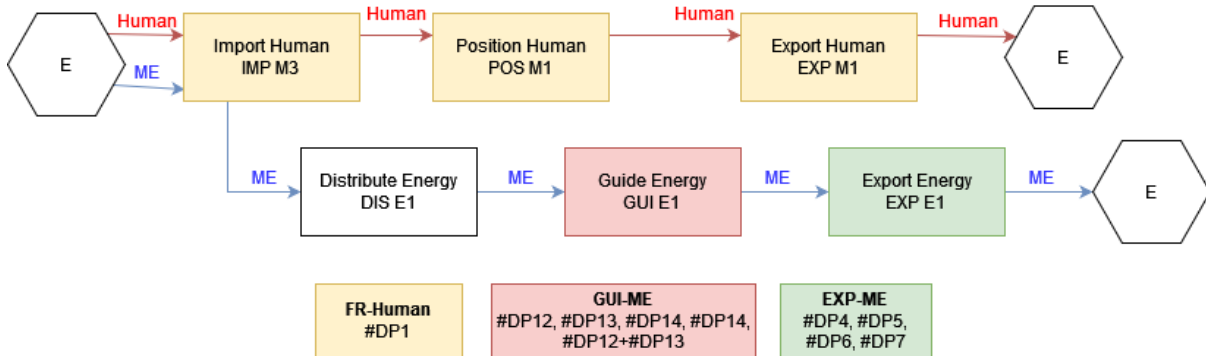

Figure F.16 Mapped function structure of the seat

F.1.11 BI-PD-11

Bicycle frame concept 1

Concept 1 of the bicycle frame is focused on lightweight design and personalisation of the product. Figure F.17 shows the combination of MRs and DPs used for the creation of the concept (Figure F.18). The frame utilises the hexagon void structures to achieve stiffness and a lightweight design. Furthermore, it incorporates embedded attachment points for attaching a water bottle, bag, or basket. The visual personalisation is embedded using geometry (letters) and colour as a part of the frame.

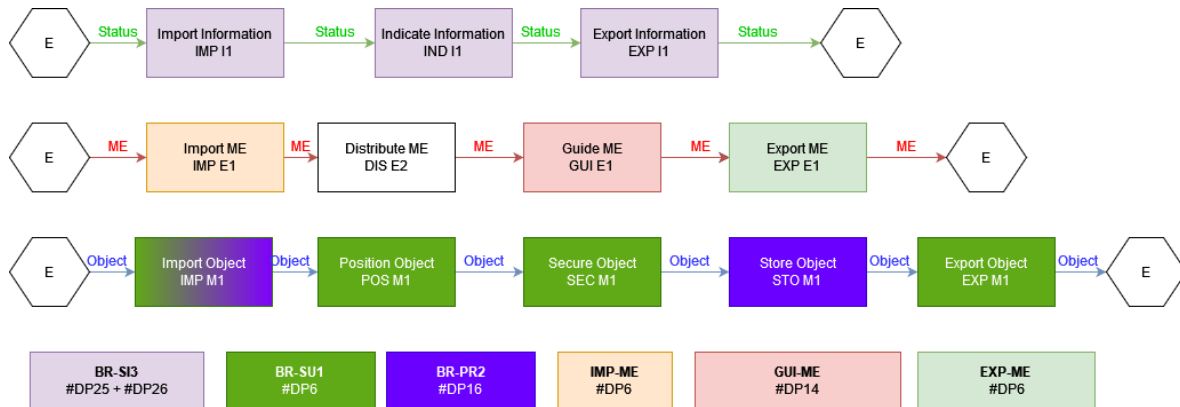

Figure F.17 MFP Structure for bicycle frame concept 1

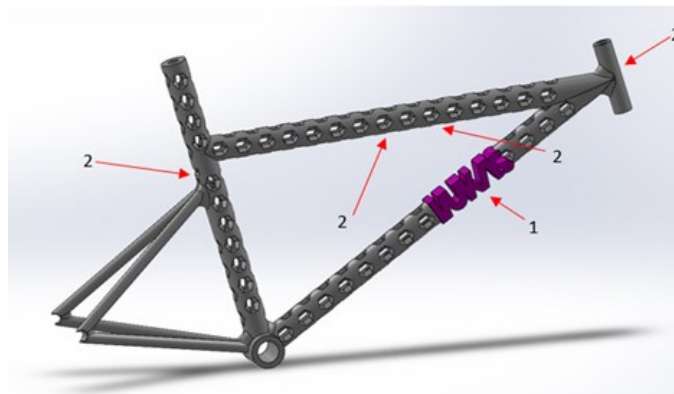

Figure F.18 Bicycle frame concept 1

F.1.12 BI-PD-12

Bicycle frame concept 2

Concept 2 of the bicycle frame is focused on lightweight design. Figure F.19 shows the combination of MRs and DPs used to create the concept (Figure F.20). The frame utilises the hexagon void structures inspired by honeycombs to achieve stiffness and lightweight design. The concept does not fulfil all the functions stated in the function structure.

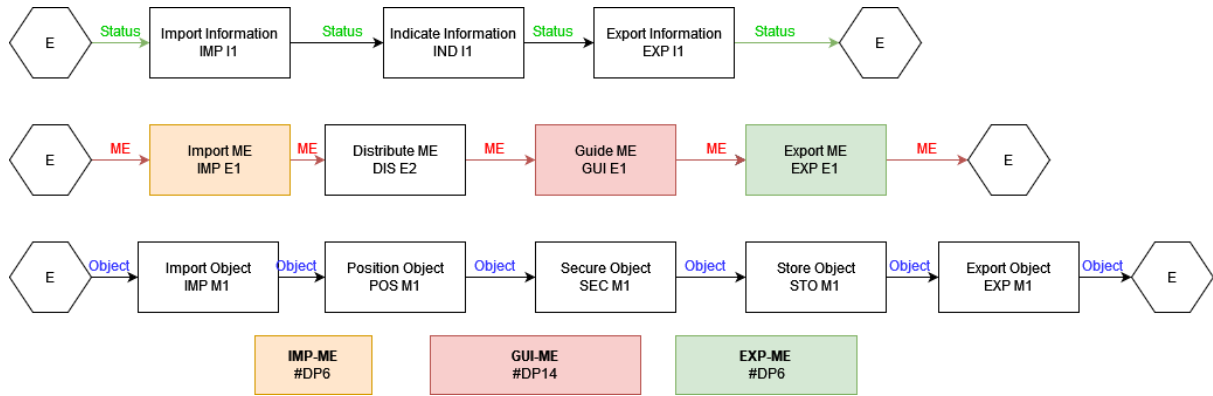

Figure F.19 MFP Structure for bicycle frame concept 2

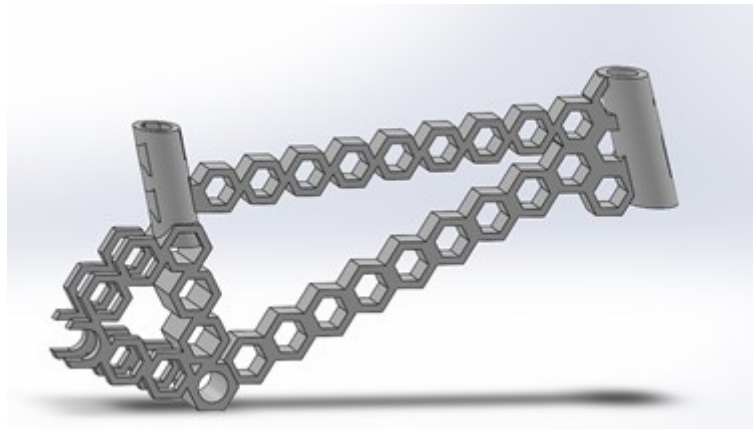

Figure F.20 Bicycle frame concept 2

F.1.13 BI-PD-13

Bicycle frame concept 3

Concept 3 of the bicycle frame is focused on lightweight design. Figure F.21 shows the combination of MRs and DPs used to create the concept (Figure F.22). The frame utilises the lattice structure inside the frame to reduce mass. The frame has three mounting points for the steering wheel so the user can adjust the position according to their liking. However, the concept does not fulfil all the functions stated in the function structure.

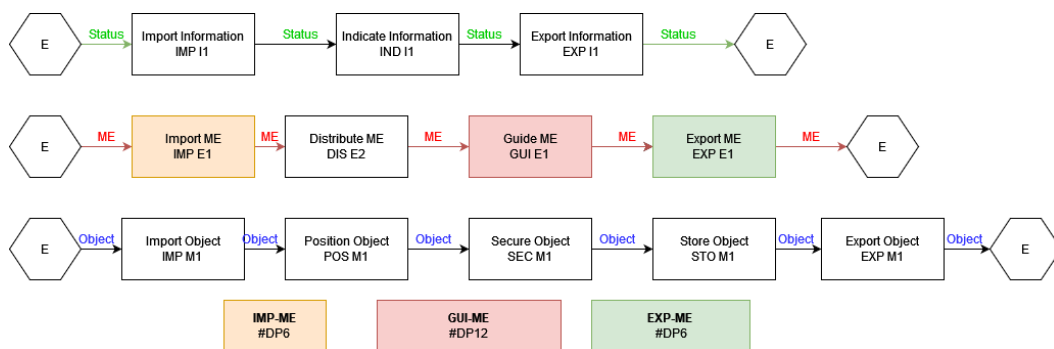

Figure F.21 MFP Structure for bicycle frame concept 2

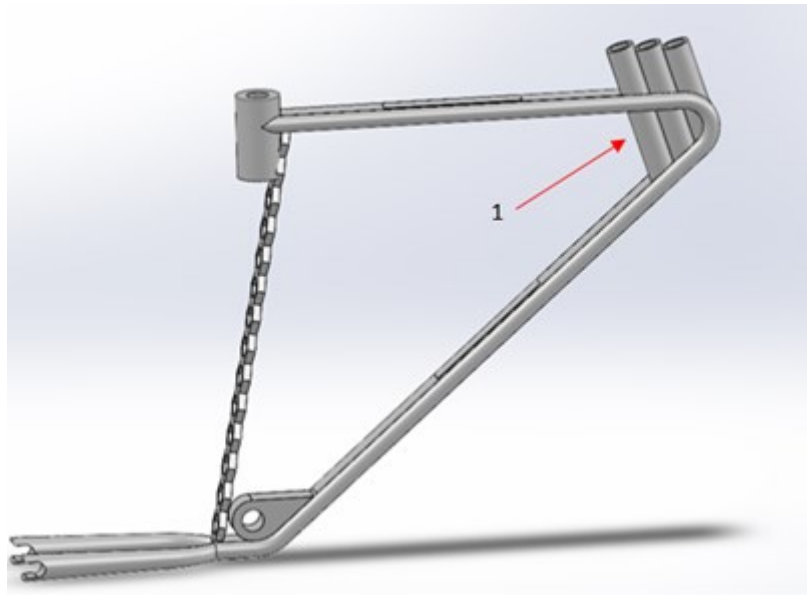

Figure F.22 Bicycle frame concept 2

F.1.14 BI-PD-14

Wheel concept 1

All three concepts of the wheel are based on the same MFP Structure (Figure F.23).

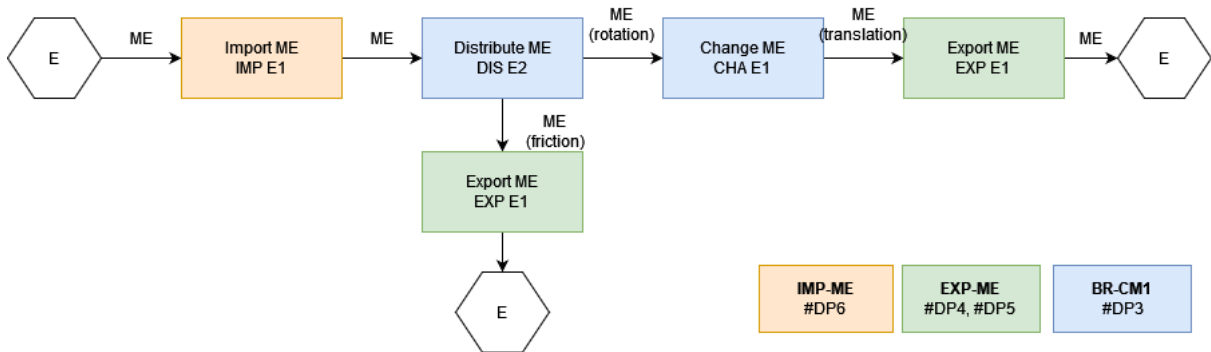

Figure F.23 MFP Structure for wheel concepts

Concept 1 is an airless tire mounted on the standard wheel using the semi-circular rib (2). The inside of the tire incorporates a brick-like structure to achieve the necessary elasticity (3). The outer surface incorporates small features for better grip (1).

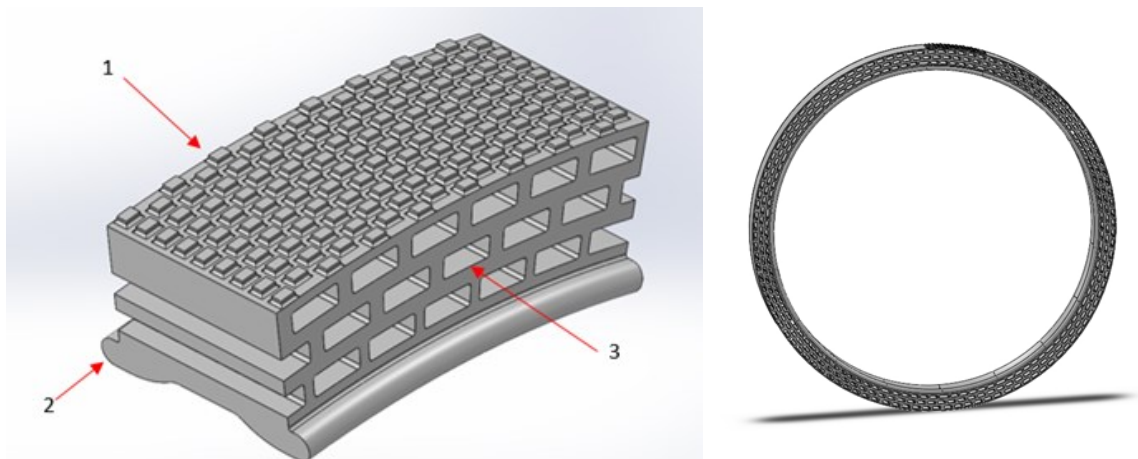

Figure F.24 Wheel concept 1

| F.1.15 BI-PD-15

Wheel concept 2

Wheel concept 2 integrates the airless tire, hub, and sprocket. The airless tire has an opening on the inner and outer surfaces. The inside is made of cross beams to achieve the desired ratio between elasticity and rigidity of the tire. The tire is connected with the hub using curved spokes. The sprocket is integrated into the hub.

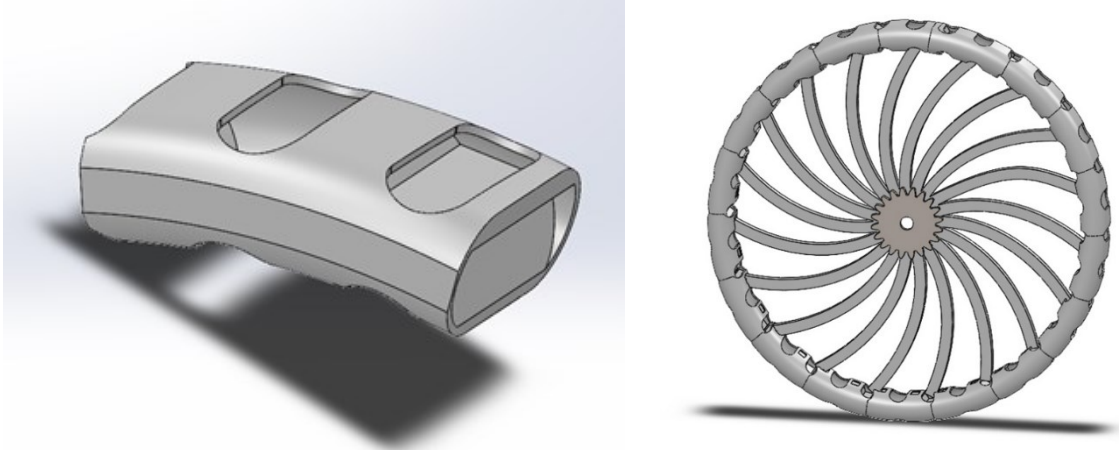

Figure F.25 Wheel concept 2

| F.1.16 BI-PD-16

Wheel concept 3

Wheel concept 3 has an airless tire with a honeycomb infill. The outer surface has a texture for a better grip. The tire is connected with the hub using spring-like spokes for better vibration absorption and as a replacement for suspension.

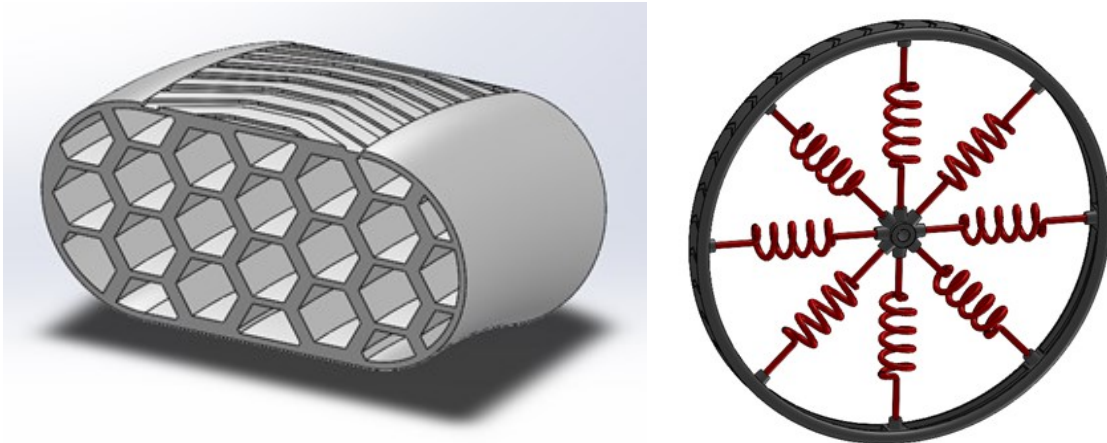

Figure F.26 Wheel concept 3

F.1.17 BI-PD-17

Seat concept 1

Seat concept 1 is ergonomically adjusted for each individual user. It incorporates a honeycomb structure to reduce the weight, and its S-shape is used for absorbing vibrations.

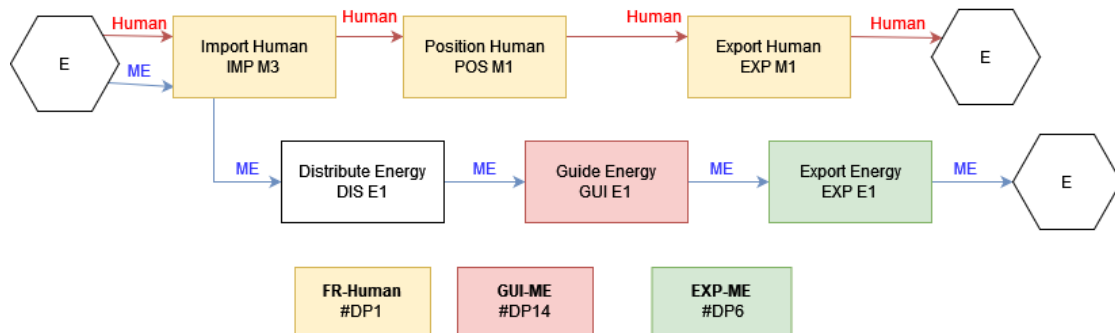

Figure F.27 MFP Structure for seat concept 1



Figure F.28 Seat concept 1

F.1.18 BI-PD-18

Seat concept 2

Seat concept 2 is ergonomically adjusted for each individual user. It has an opening to allow air to pass and reduce the weight. The seat is connected with the standard attachment tube using a topologically optimised structure that transfers the weight of the user.

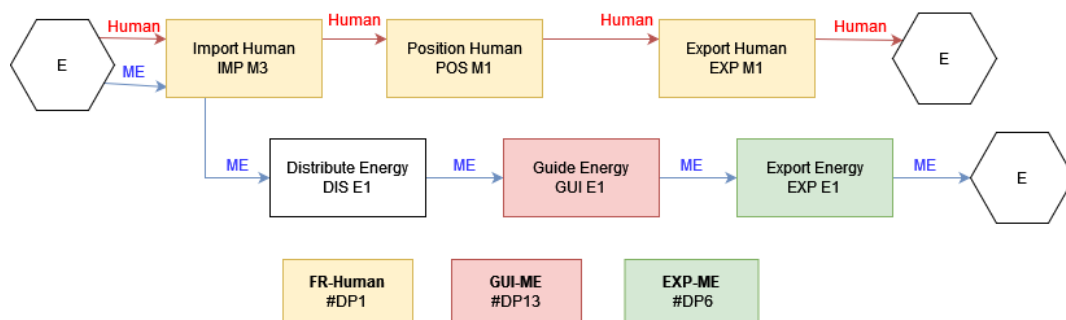

Figure F.29 MFP Structure for seat concept 2

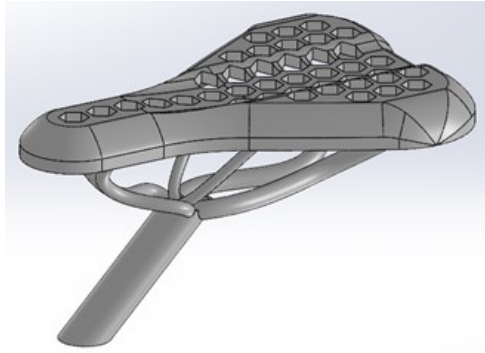

Figure F.30 Seat concept 2

| F.1.19 BI-PD-19

Prototypes

Figure F.31 shows the prototypes used for the evaluation of the concepts. Using the FDM process, prototypes are made from PLA, PETG, and TPU materials. The figure also shows a scaled model of the bicycle's final design.

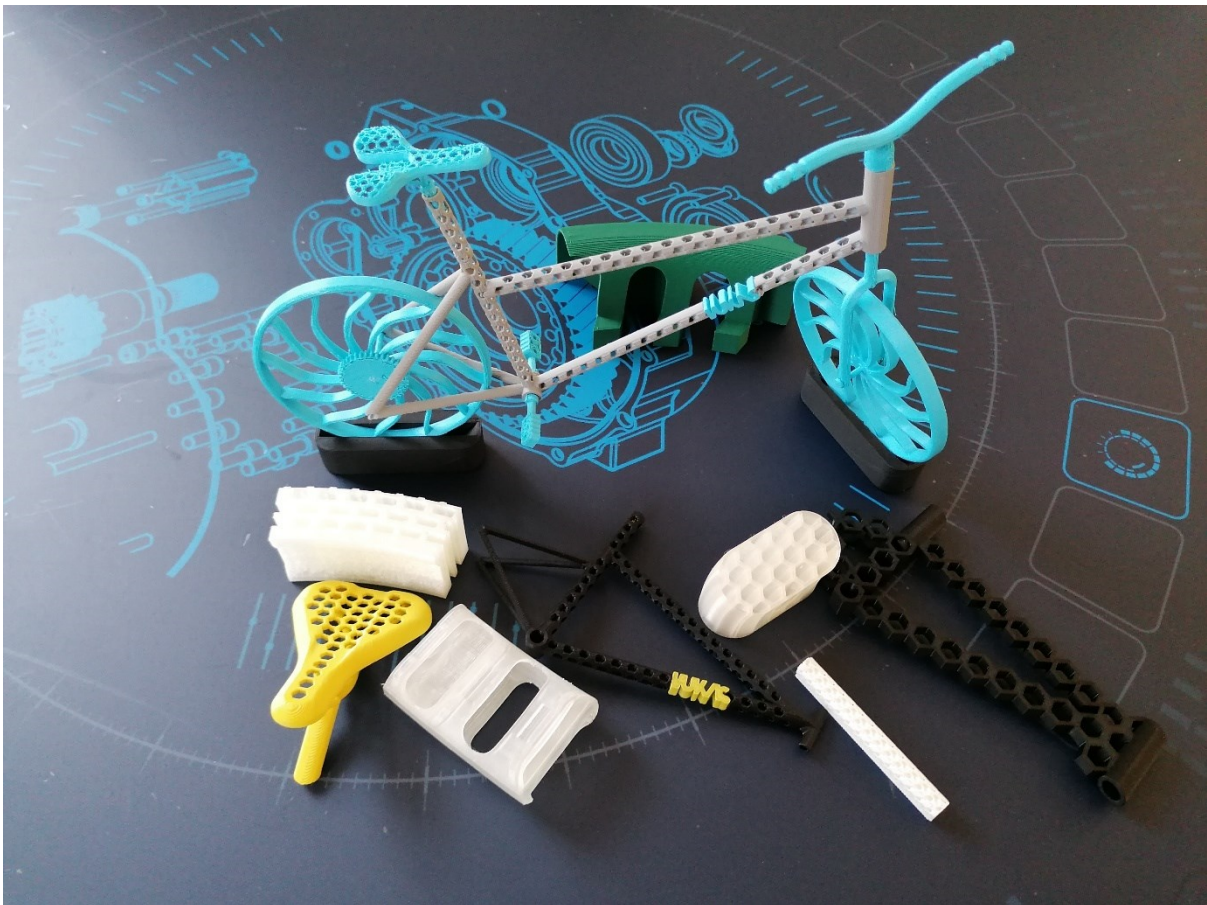

Figure F.31 Prototypes of the bicycle and its parts

| F.2 Observation Notes

| F.2.1 BI-ON-01

Project setup observations, October 2021

- The agreement was reached that the topic of the bachelor thesis project would be the design and product development of an AM product.
- The designer was given a task to find and choose the product that would be redesigned. Through discussion between Designer B and the author, an agreement was reached that the project would be the design of AM bicycle. The mapping methodology will be used to design one or more components of the bicycle with exact components to be defined after conducting initial project steps.
- The supervisor approved the topic of the project and the product to be designed.

| F.2.2 BI-ON-02

Observations of FC learning process, 9th November 2021

- The FCs approach was introduced and explained to Designer B. As she had previous knowledge about function modelling focus of the lecture was on the FCs approach. The lecture lasted approximately 30 minutes. The lecture explained the logic of the FCs approach and its role in function modelling. Furthermore, the list of FCs was shown as a template for creating function blocks, and primary and modelling rules were explained. Five examples of function structure were shown and explained to the designer.
- The designer has shown an understanding of FCs, the logic of using FCs in functional modelling and the examples shown.
- After the introductory lecture on the FCs approach, the designer was given the task of creating the function structures of a bicycle. Two instructions were given:
 - o To create a function structure of the entire bicycle as an assembly,
 - o To create function structures for two or more individual bicycle components of her own choosing.

| F.2.3 BI-ON-03

Observations during first function structure review, 22nd November 2021

- Designer B submitted 7 function structures for the first review. One function structure was for an entire bicycle, while the other 6 were for individual bicycle components (wheel, pedal, bicycle frame, hand brake lever, seat, and steering wheel).
- When asked how she approached the function modelling and whether was hard to follow the FCs and modelling rules, the designer responded that she first created function structures without following FCs approach and then “translated” them onto the language of FCs. She said it was easier for her to think and model functions in a natural language as she is familiar with this approach. She reported that it was mostly easy to translate the natural language function structure to FCs, but there were functions she had trouble with (e.g., Converting rotational motion to translation motion).
- The submitted function structures contain 56 functions in total and are mostly in compliance with FCs and modelling rules. However, the graphical representation is not strictly followed, as the designer used the colours of her own choice to represent the flows. The noted errors were given in written form and verbally explained during the review session.

- The function structure of the entire bicycle had minor errors in regard to FCs. However, during the discussion, the designer was not able to clearly explain the functionality of the bicycle and what individual functions represent. As there are functions that repeat on multiple occasions on different function chains (Guide ME, Change ME) it was hard to follow which function is which. Because there are two imports of Human Material and Human Energy, it was not clear what each function represents. The designer was asked to review the function structure and create a new iteration.
- The function structure of the wheel was only based on the flow of ME and had two errors in modelling. The designer was instructed to correct the noted errors but also to think could the flow of material on which ME of the wheel is transferred be added to the function structure.
- For the function structure of the pedal, there were no significant errors, and the designer had a good understanding of the functionality.
- The function structure of the bike frame is fully compliant with FCs. However, it only represents the flow of ME through the frame. The designer was instructed to think about additional functionalities such as carrying accessories such as a water bottle or bag for storage. Furthermore, functions regarding aesthetics and embedding of information into the frame were suggested.
- The function structure of the hand brake lever represents only the lever of the brake and not the entire braking system. This was not clear at first during the review. The designer was instructed to revise the function structure for the entire system. Also, additional functions such as Indicate Information were suggested.
- For the function structure of the seat, everything was clear. However, it was suggested to remove the function Secure Human as this function suggests holding a human firmly in place.
- The function structure of the steering wheel was clear. The addition of function the Allow DOF was suggested.

| F.2.4 BI-ON-04

Observations during second function structure review, 28th November 2021

- The revised function structure of the entire bicycle did not include significant changes, and the functionality of the entire system is not clear. The designer stated issues encountered are: too many similar functions, problems with modelling interaction between the components, and issues in identifying subfunctions of the bicycle. Due to issues, the function modelling of the entire bicycle is removed from the project.
- The function structure of the wheel now includes a function Change ME as an expression for absorbing vibrations.
- The function structures of the bicycle frame include additional functionalities. The overall functionality is clear. Minor issue with understanding what POS M2 means. Through discussion, a conclusion was reached that the function must be replaced with POS M1 which does not include the flow of energy.
- The function structure of the seat now does not include the function Secure Human.
- Due to the project requirements, it is decided that only concepts for Seat, Wheel and Bicycle frame will be made.

| F.2.5 BI-ON-05

Observations during mapping lesson, 5th December 2021

- Mapped function structures with all applicable rules and design principles are presented to the designer. Mapping rules and design principles are explained together with logic and the method of how they are applied. The rules that are applied are thoroughly explained, together with possible mappings of design principles.
- The designer is instructed on how to use mapped function structures, how to choose the possible solutions and how to use them in generating concepts.
- The designer is instructed to create multiple concepts as she sees fit according to the design requirements and using mapped function structures and AM design principles.
- The designer understood the mapping logic and was given all supplementary materials about function mapping and design principles needed for generating concepts.

| F.2.6 BI-ON-06

Observations during concept reviews, December 2021

- The designer presented multiple concepts of frame, wheel, and seat. The concepts are already modelled in CAD. The designer explained all concepts and reasoning behind the chosen design solutions.
- The concepts utilise many of the AM DPs. However, due to designers' CAD modelling skills, the shapes are relatively simple.
- The designer is instructed to modify and scale the model to achieve printability during prototyping.

| F.2.7 BI-ON-07

Observations during prototyping and product development, January-February 2022

- All concepts are prototyped in a scaled-down version using FDM process.
- The designer showed a good understanding of AM capabilities inside the DPs and was able to use them in CAD modelling and prototyping.
- The prototyping showed the successful embodiment of DPs incorporated into the concepts.
- The prototypes are used for the evaluation of concepts.
- After evaluating concepts, the final design of the AM bicycle is created and successfully manufactured in scaled size.

| F.2.8 BI-ON-08

Observations during FM App testing, 11th March 2022

- The FM App was introduced to the designer, and she was asked to recreate the function structure of the bicycle frame and conduct the mapping.
- The designer quickly grasped how to use the app and successfully made the required tasks.
- No issues in using the app are observed.

F.3 Interview Transcript

Interview conducted on 11th March 2022. The interview was conducted in Croatian, and the transcript was translated into English, with minor syntax corrections.

F.3.1 BI-IN-01

Background information

Interviewer: Did you have any experience with function modelling before this project? If yes, please describe your previous experience with function modelling. What kind of function models did you create, for which products and how many?

Designer B: *Yes, I have experience through [courses] “Product Development”, “Engineering Design - Methods and Tools” and “Computer Integrated Product Development”. In “Computer Integrated Product Development” we created a [function] model of the entire device, while in the other two [courses], we modelled simpler products. The [function] model was for the waterways cleaning device. Here we had to model function structures for subsystems.*

Interviewer: During that function modelling, you used your own definitions of functions and flows?

Designer B: *Yes.*

Interviewer: Did you have any experience with additive manufacturing and design for additive manufacturing before this project?

Designer B: *In “Engineering Design - Methods and Tools” [course], I learned about DfAM, but I never worked with it [in practice].*

F.3.2 BI-IN-02

FC Method

Interviewer: When you think back about the introductory lecture on function modelling using the Function Class approach, what was your impression about the approach? Did you understand the concept of Function Classes and the templates and rules provided during the lecture?

Designer B: *Yes, I think it was quite easy to learn [Function Class approach]. Maybe it was a bit of a problem to switch [from no defined language] as I’m used to “classic function structures” from “Product Development” [course].*

Interviewer: What was your experience using the Function Class modelling approach, including templates and rules you received in paper and PDF format? Were the vocabulary, FCs, and rules clear and understandable?

Designer B: *Well, everything is explained [in the templates and rules]. I went through a list and found a function that corresponds to my need, and that’s it.*

Interviewer: Now that you redo your function structure using the Function Modelling App, can you compare your process of creating function structure using paper and the process using the application? What process do you prefer, and why?

Designer B: *It is faster with the app because everything is immediately suggested. You don’t have to search much.*

Interviewer: Was there some negative characteristic of the app?

Designer B: *No, everything was fine [with the app].*

Interviewer: Please describe your function modelling process using Function Class from a logical point of view. What was your approach to the function modelling process? Please describe the way you created the function structure and highlight the difficulties you encountered and what you find helpful during function modelling.

Designer B: *Firstly, I made a list of functions for every part [of the bicycle]. Then I made a “classic function structures” as these [FCs templates] were a bit abstract for me at the beginning. Then I used those functions [from the previously created list and function structures] to look for the most similar functions in the list and looked for additional functions that could be incorporated into the function structure.*

Interviewer: To clarify, these initial lists of functions and “classic” function structures were made using Croatian or English language?

Designer B: *On Croatian language.*

F.3.3 BI-IN-03

Mapping Method

Interviewer: When you think back about the lecture on methodology for mapping product functions with design principles for AM, what was your impression about the approach to find solutions that way? Did you understand the concept of mapping methodology and rules provided during the lecture? Can you maybe compare this approach with the morphological matrix you used before?

Designer B: *In the morphological matrix the solutions are more focused, but I have to form them myself. Here the solutions are more abstract. For example, “custom interface” is quite a broad [solution].*

Interviewer: What was your experience using tools for mapping product functions (rules and list of principles)? Were the mapping rules clear and understandable?

Designer B: *Yes, with the examples provided, it was clear enough.*

Interviewer: Now that you used the application for the mapping process, can you compare it with the mapped function structures you used before?

Designer B: *The app was quite simple to use. It is like the draw.io I used before.*

Interviewer: Were the design principles provided for the mapping process understandable? For example, were you able to comprehend the meaning of design principles and the meaning of AM possibilities they were referring to?

Designer B: *It depends. Some were straightforward, and others were a bit unclear.*

Interviewer: Please describe your process of generating concepts using mapped function structures that were given to you. Could you describe how the mapping function structures influenced your approach to generating concepts? Please highlight the difficulties you encountered and what you find helpful during the concept generation process.

Designer B: *I think it [mapped function structures] was most important for the bicycle frame as there were most mapped solutions. For the wheel and seat, solutions were more or less similar [among possible mappings]. For the frame, I went through the options [suggested DPs] and looked for possible combinations among them. I got three totally different concepts through this process.*

Interviewer: Were there some issues in such an approach to generating concepts? For example, if you compare it with the morphological matrix.

Designer B: *I think I would have more different solutions if I used a morphological matrix, as a lot of functions were solved with custom geometry or standard interface. Therefore, mappings for each concept were quite similar. On the other hand, for the bicycle frame it was OK.*

Interviewer: What is your opinion about the solutions the mapping process suggested to you?

Designer B: *I think all functions were covered quite well. Only a small number of functions were not mapped in the end.*

Interviewer: Did you find the quality and broadness of suggested solutions adequate?

Designer B: *Yes.*

Interviewer: Did you maybe have some ideas that were not suggested mapping rules?

Designer B: *Yes, I thought about the design heuristic I learned about in “Engineering Design - Methods and Tools” course.*

Interviewer: Do you think the mapping process enabled you to achieve function integration (solving two or more functions with the same technical solution)? Please provide an example if possible.

Designer B: *Yes. For example, reducing weight and absorption of vibrations could be solved with one solution like lattice structure.*

| F.3.4 BI-IN-04

Other information

Interviewer: Now that you tested the application, what is your opinion on using the Function Mapping App in comparison to the use of paper and PDF materials?

Designer B: *I think more things are noted this way when you need to click to find an appropriate solution. On papers, I miss some things when I go through them.*

Interviewer: Would you maybe change something in your function structures or mapping now that you have used the application?

Designer B: *I think I could achieve a greater level of integration in a frame, as I basically have three function structures in one at the moment [three unconnected function chains] that I could connect.*

Interviewer: Do you have any additional comments or thoughts about the entire process of function modelling, mapping, and concept generation? Something that was helpful, something you didn't like, or something you would like to change?

Designer B: *I think that if I have to learn it [the function class approach] from the beginning, it would be much easier as it [the application] is quite intuitive. However, if somebody else looks at the function structure, it is a bit harder to comprehend as it is different from “classic” function structures, as this one is a bit more abstract.*

Appendix G

Case study 3: Toy Car

The following sections present data gathered in Case Study 3. First collected projected documents are presented. The project documents consist of function structures, mapped function structures, and concepts. For each document, a short description and figure are provided. Next, observation notes are presented, followed by interview transcripts.

| G.1 Project documents

| G.1.1 TC-PD-01

Function structure of the toy car

Figure G.1 shows multiple function structures of the toy car as an entire system. As the designers used FM App during function modelling, only a few errors in using FCs are encountered, and modelling rules are mostly followed, but some errors exist.

The first structure imports gas stored in a balloon and wheels on which the PE and ME are transferred. The functions Secure Gas and Position Gas refer to the attachment of the balloon, but they are applied in the wrong contexts. No Export function for gas exists.

The second function structure represents only the flow of energy and lacks a broader set of functions. The function structure is fully compliant with the FCs. The overall functionality is clear.

The third and fourth function structures build on the logic of the first one. The third has an additional function where the status of ME is observed. The fourth function structure incorporates the flow of wheels on which the ME is transferred. It also has the function Stop Solid which corresponds to the braking capability of the toy car.

The fifth function structure includes the flow of Human whose energy is converted into PE. It also incorporates the flow of the surface used for representing the transfer of ME onto it to enable the movement of the car.

In all five function structures, the main functionality of the toy car is expressed. However, none of them captures the full functionality that satisfies additional requirements besides the propulsion.

| G.1.2 TC-PD-02

Mapped function structure of the toy car

Due to the similarity of function structures, the used MRs and DPs are repeated in all three function structures. Some functions were not mapped, and designers suggested DPs they considered as a solution for these functions.

Appendix G. CS3: Toy Car

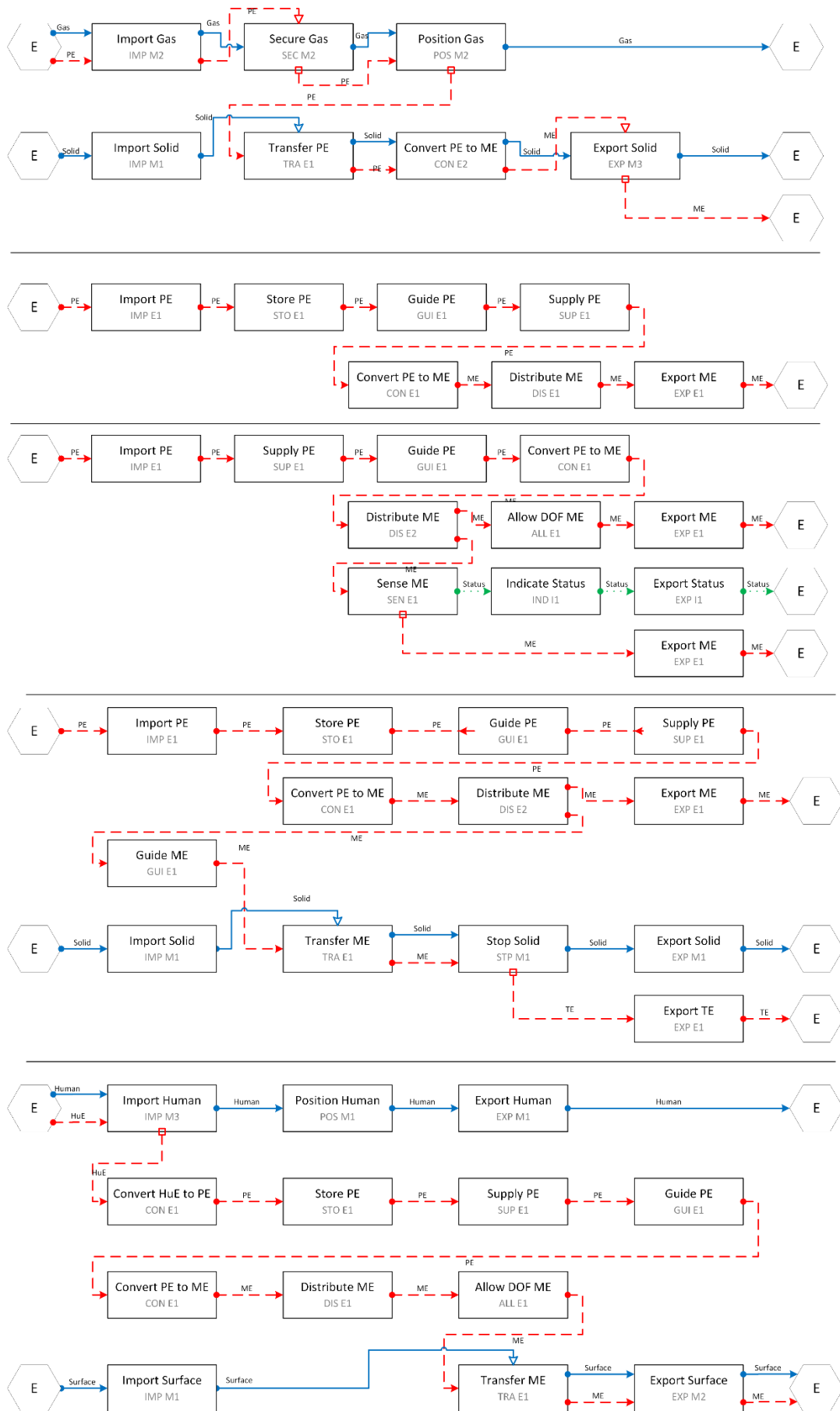

Figure G.1 Function structures of the toy car system

Appendix G. CS3: Toy Car

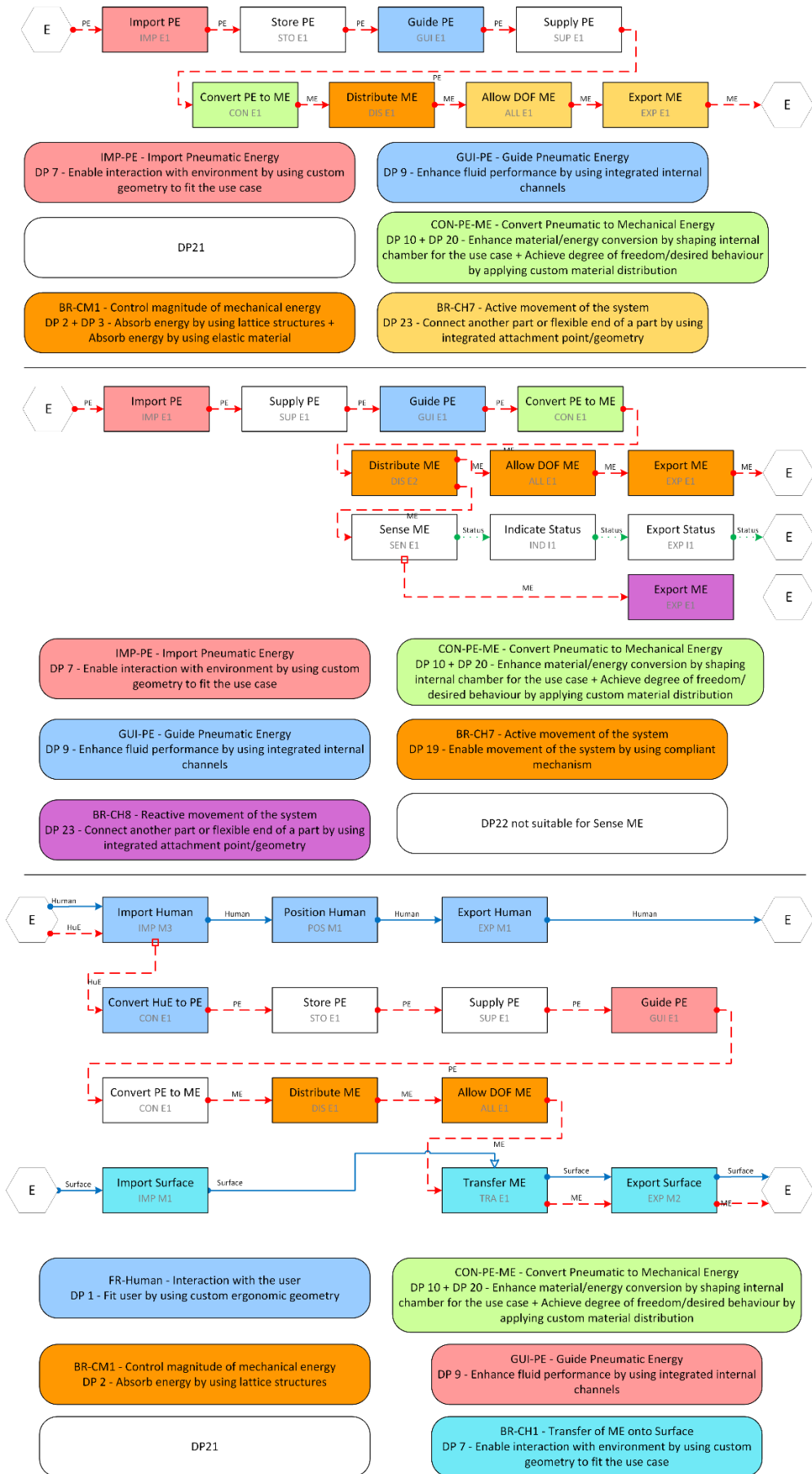

Figure G.2 MFP Structure of the toy car

G.1.3 TC-PD-03

Function structure of the wheels

Figure G.3 shows two function structures of the wheels. The first iteration of the function structure (top) contains the function Allow DOF, which describes the movement of the system. Because the wheels as a system are rigid, this function is removed in the second and final iteration.

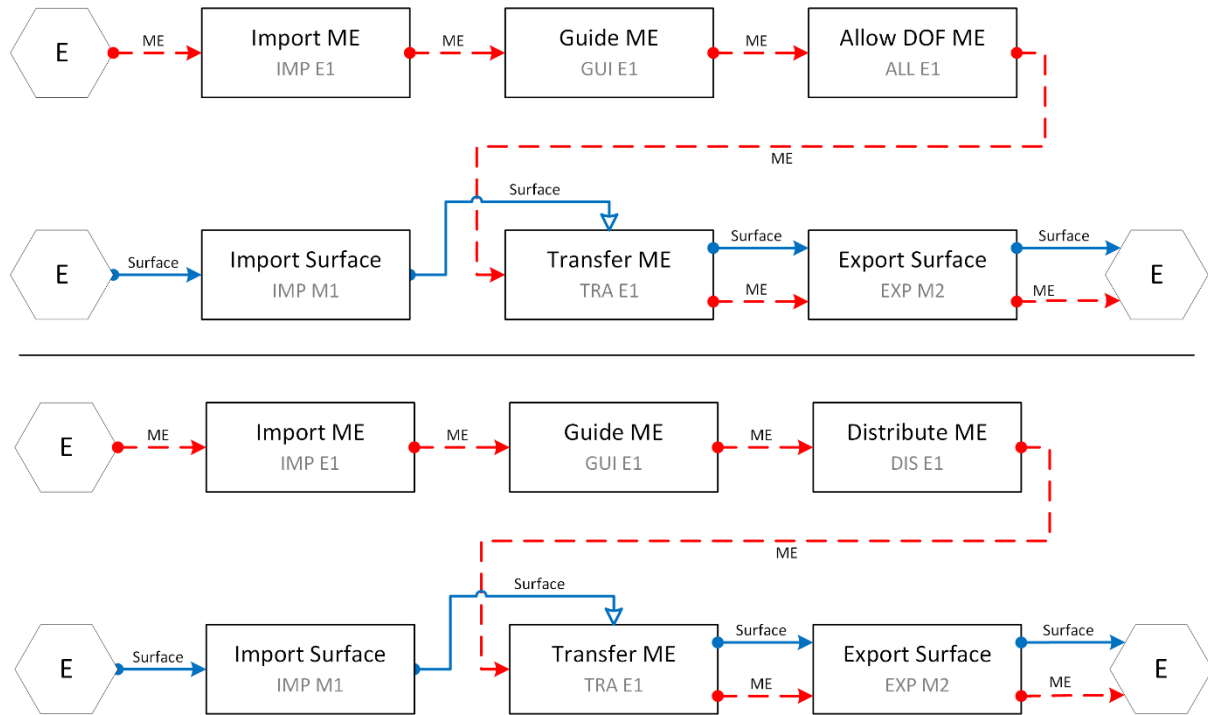

Figure G.3 Function structures of the wheels

G.1.4 TC-PD-04

Function structure of the propulsion

Figure G.4 shows two function structures of the propulsion system. Same functions are used in both cases, and the structures differ in the way how carrier-carried relation is represented.

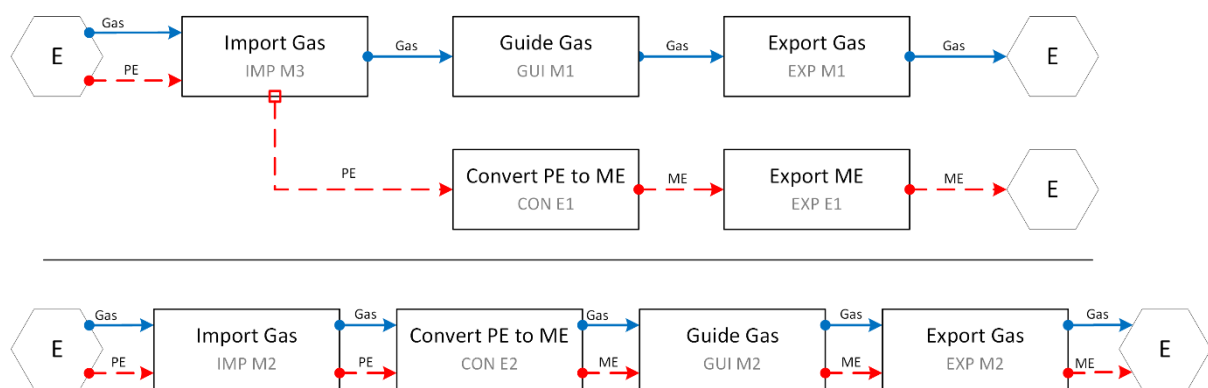

Figure G.4 Function structures of the propulsion

G.1.5 TC-PD-05

Function structure of the chassis

The function structure of the chassis imports the flow of ME (from the propulsion) and transfers it onto the wheels.

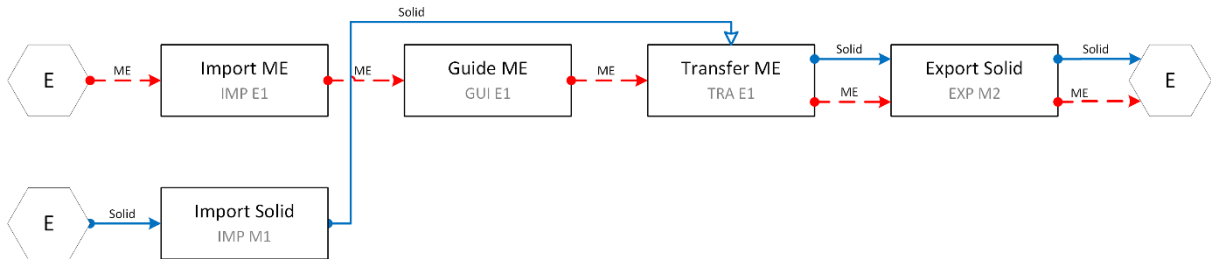

Figure G.5 Function structure of the chassis

G.1.6 TC-PD-06

Function structure of the chassis and the propulsion

The function structures of the chassis and the propulsion are combined into one integrated function structure. All their functions are combined and make the top function chain (Figure G.6). Furthermore, the function structure incorporates an additional function chain for representing the functions in case of hitting the wall (*Stop Solid*) and embedded visual information.

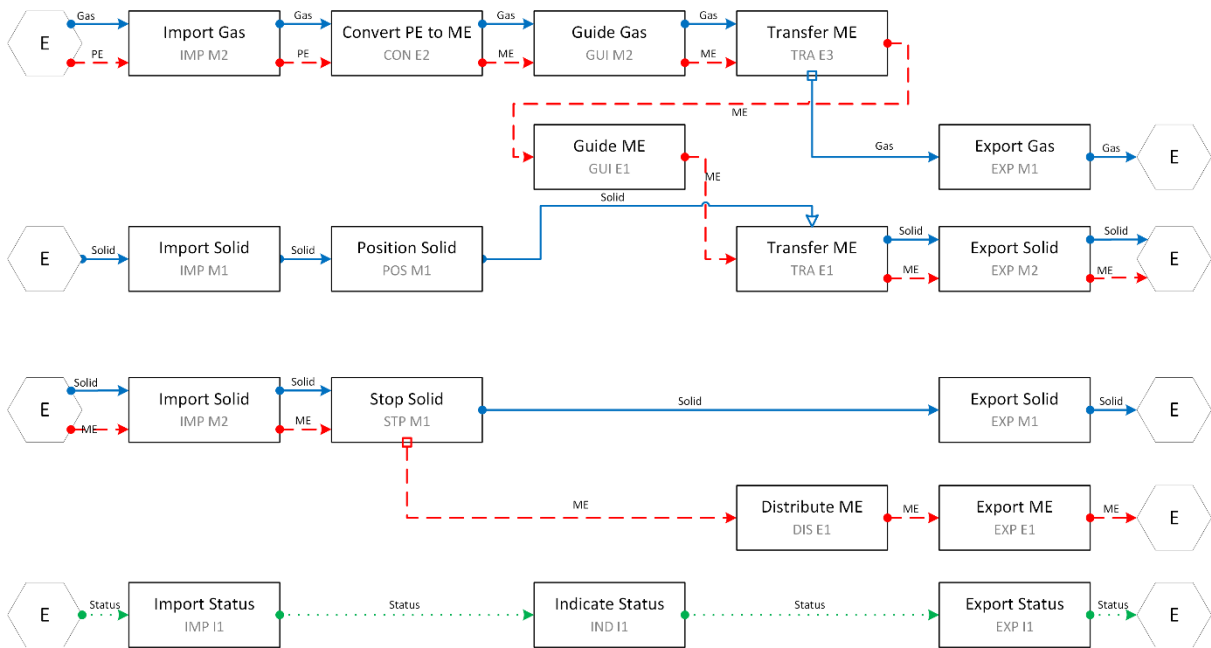

Figure G.6 Function structure of the chassis and the propulsion

G.1.7 TC-PD-07

MFP Structure of the wheels 1

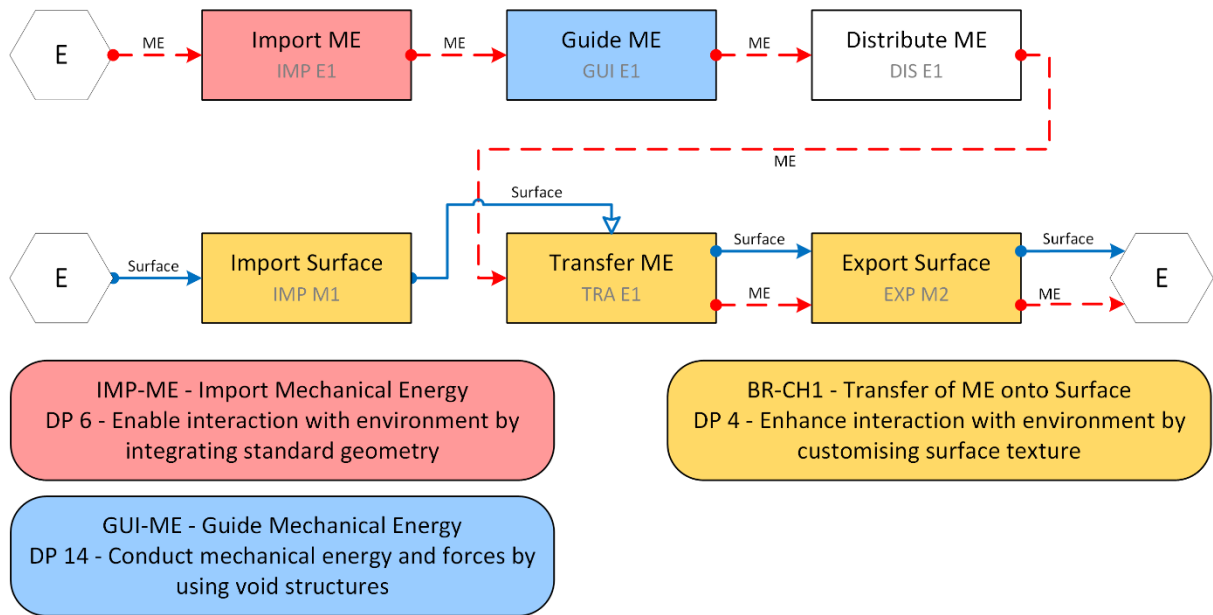

Figure G.7 MFP Structure of the wheels 1

G.1.8 TC-PD-08

MFP Structure of the wheels 2

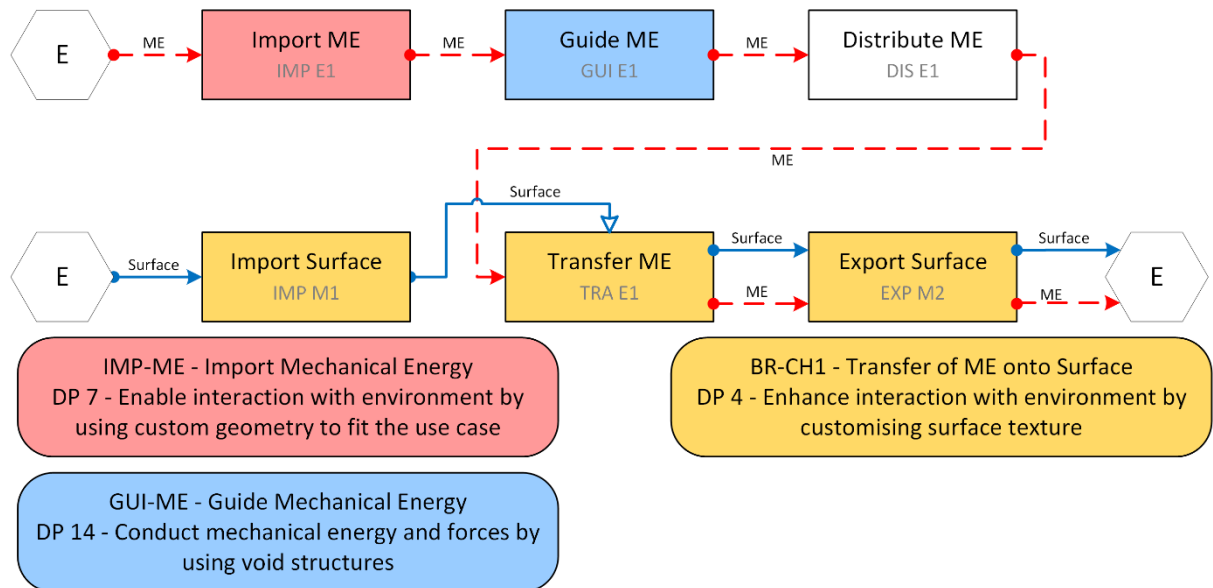

Figure G.8 MFP Structure of the wheels 2

G.1.9 TC-PD-09

MFP Structure of the chassis and the propulsion 1

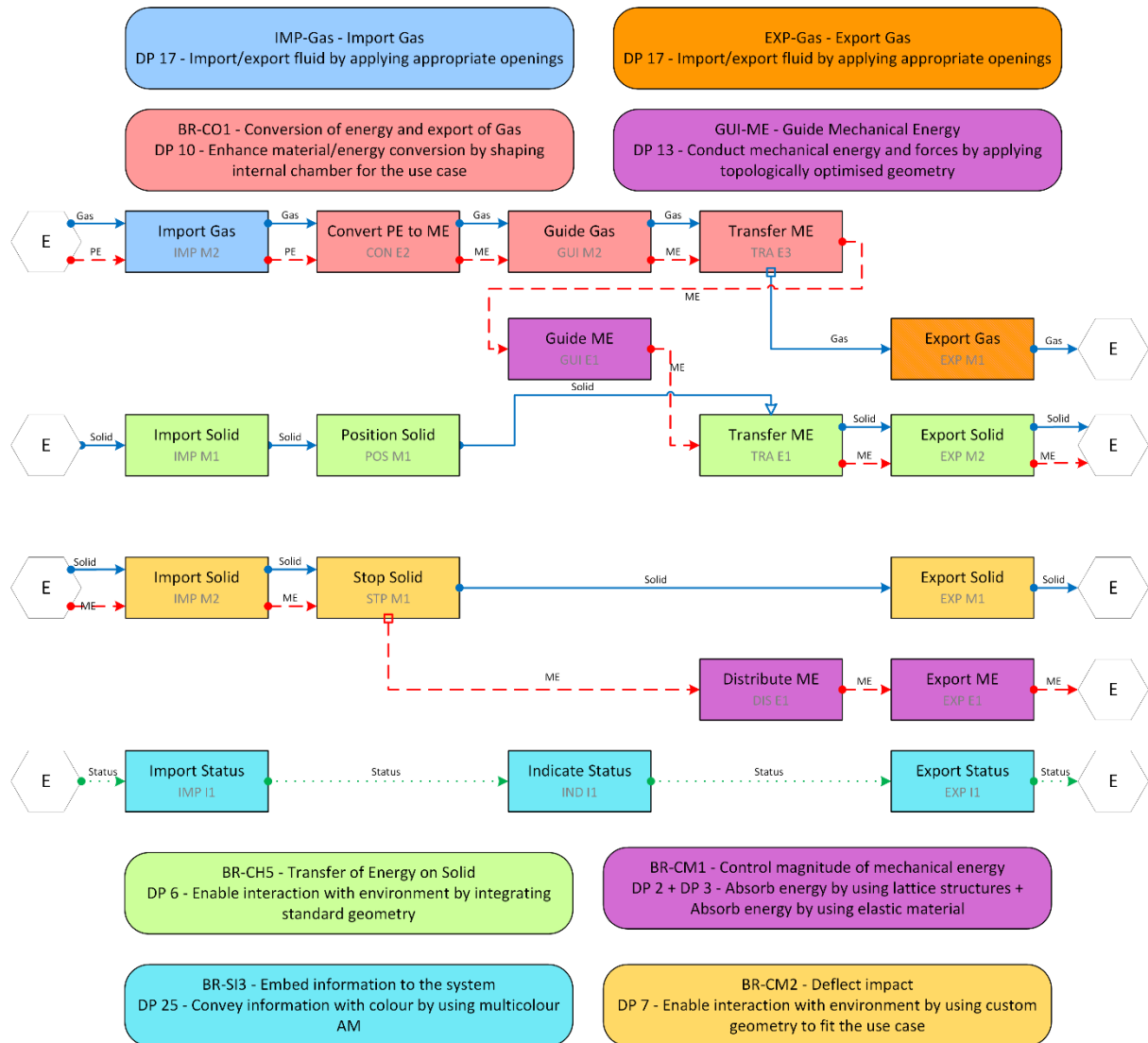

Figure G.9 MFP Structure of the chassis and the propulsion 1

G.1.10 TC-PD-10

MFP Structure of the chassis and the propulsion 2

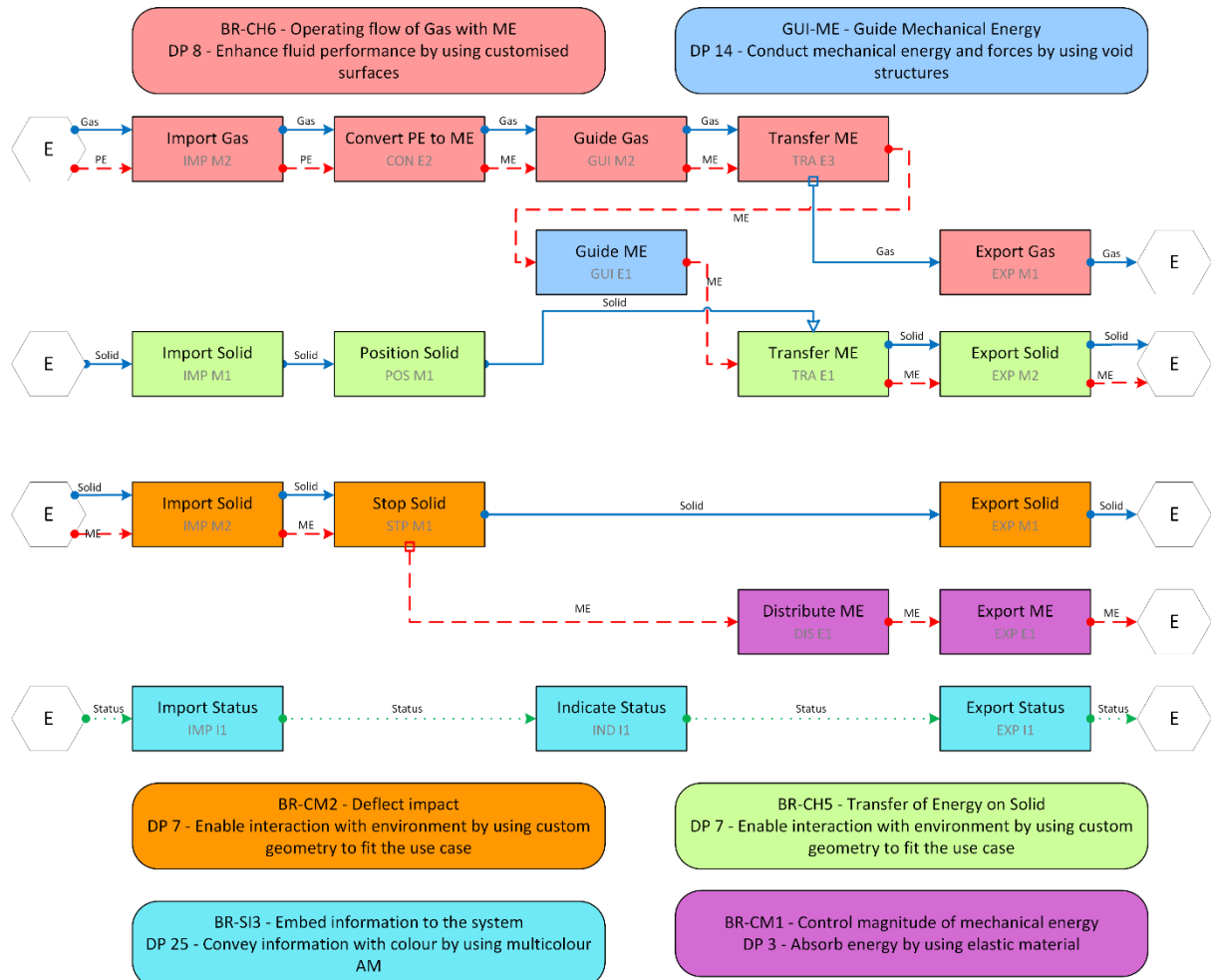

Figure G.10 MFP Structure of the chassis and the propulsion 2

| G.1.11 TC-PD-11

Concept 1

Concept 1 is based on the MFP structure of the wheels 2 (Figure G.8) and MFP structure of the chassis and propulsion 2 (Figure G.10). The attachment point for the balloon is on the back of the toy car. The air is guided using the internal channel to blades mounted on the rear axle blades. The air rotates the axle and spins the wheels. The wheels infill is in the form of void structures to reduce the weight. The chassis of the toy car uses multicolour AM for aesthetic reasons. The red stripes are bumpers made of elastic material to reduce the impact on other objects.

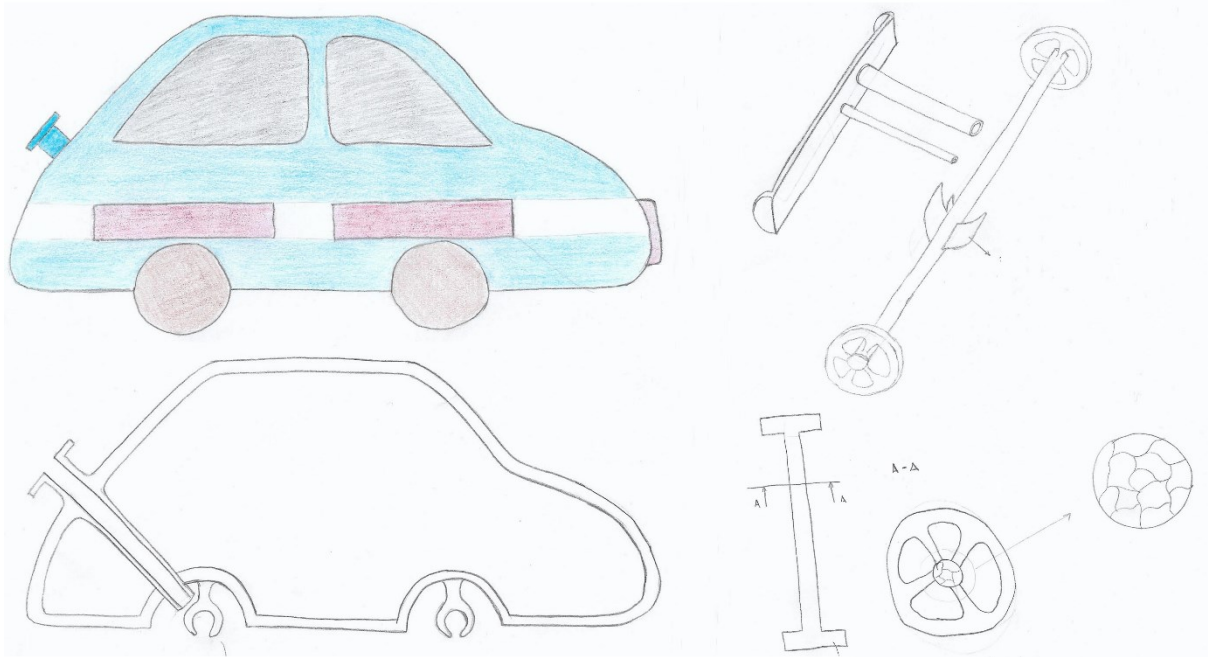

Figure G.11 Toy Car Concept 1

| G.1.12 TC-PD-12

Concept 2

Concept 2 is based on the MFP structure of the wheels 2 (Figure G.8) and MFP structure of the chassis and propulsion 2 (Figure G.10). On the back of the toy car is the attachment point for the balloon. The air is guided using an internal channel through the tube in the place of the rear axle. The wheels are mounted onto the tube, and the air propels the wheels using the blades on the inner rim of the wheels. The front wheels infill is in the form of void structures to reduce the weight. The chassis of the toy car is made of lattice structure and uses multicolour AM for aesthetic reasons. The red stripes are bumpers made of elastic material to reduce the impact on other objects.

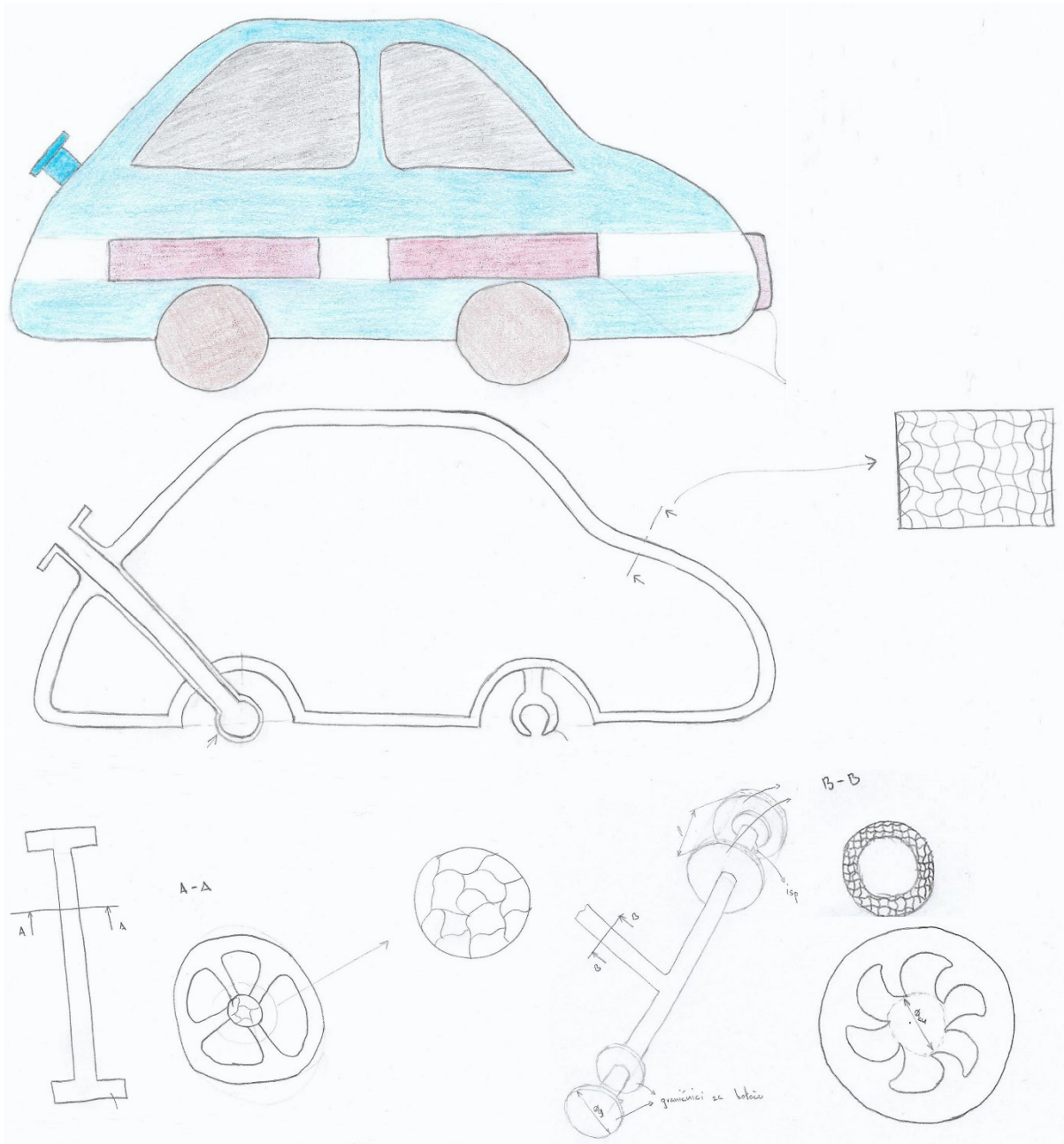

Figure G.12 Toy Car Concept 2

| G.1.13 TC-PD-13

Concept 3

Concept 3 is based on the MFP structure of the wheels 1 (Figure G.7) and the MFP structure of the chassis and propulsion 1 (Figure G.9). On the top of the toy car is the attachment point for the balloon. The air is guided using an internal chamber and exits at the back of the car, thus pushing the car forward. The wheels have a surface texture for better grip. The chassis of the toy car uses multicolour AM for aesthetic reasons.

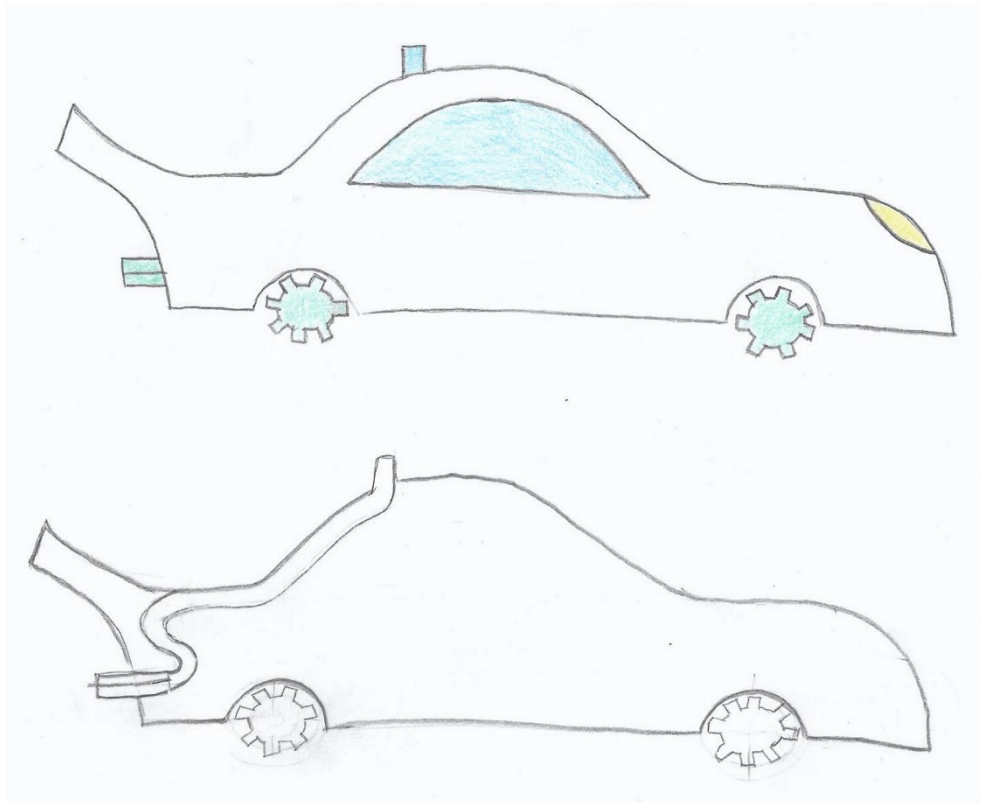

Figure G.13 Toy Car Concept 1

| G.2 Observation notes

| G.2.1 TC-ON-01

Project setup notes, January-February 2022

- The project was agreed with a dual purpose, firstly, to conduct a new design project for the purpose of gathering data for the validation of mapping methodology, and secondly, to introduce designers in this project to new design methods and tools as an introduction for future projects.
- It was agreed the task would be conducted by two designers.
- The agreed task was the development of a toy car powered by air stored in a party balloon.

| G.2.2 TC-ON-02

Observations during FC lecture, 7th March 2022

- Neither Designer C nor Designer D had any previous experience with function modelling. Thus introductory lecture was organised. It included an introduction to function modelling and development of function structures, an explanation of the FCs approach, and a demonstration of the Function Mapping App.
- Before the lecture and the project, designers didn't see any other function, such as function structure with Hirtzs' vocabulary or function structure without defined vocabulary.
- The lecture explained the logic of function modelling and why it is used in the design process. An example of function structure using natural language was created and explained.
- Furthermore, the list of FCs was shown as a template for creating function blocks, and primary and modelling rules were explained. Five examples of function structures created with the FCs approach were shown and explained to the designer.
- Designers showed an understanding of function modelling, the use of FCs and the shown examples.
- A short demonstration of the Function Mapping App was conducted. It included a basic explanation of MS Visio, starting of FM App, how to create a function block, how to connect the flows and how to delete a function block. The demonstration of mapping functionality was left for a future lecture.
- After the introductory lecture on function modelling, a design task was explained to the designers. They were given instructions to create one or more function structures of the car toy as an entire assembly and not to create function structures of individual components.

| G.2.3 TC-ON-03

Observations during function modelling and review of function structures, 8th – 10th March 2022

- During the project, designers worked in the same office as an author. This enabled passive observation of their work and eased communication. They combined the paper-based approach with the use of the FM App during function modelling, where they first sketched out the outline of a function structure on paper during brainstorming and then tried to create it in the FM App.
- At the beginning, designers had trouble with choosing appropriate FCs for the desired functionality, and it was observed they had to check the list of FCs very frequently. As they got familiar with the vocabulary and FCs, the efficiency and accuracy in applying FCs were observed.
- Designers firstly created a few function structures with varying degrees of success in representing the functionality of the toy car. This was expected as they were conducting function modelling for the first time. As they used the FM App, no syntax errors were made in function structures.
- The designers had trouble modelling the toy car as a system, and they tried to model the wheels as the flow of solid entering the system.
- Designers could express the main functionality regarding the propulsion but had trouble with modelling additional function chains, for example, to model functions regarding the requirement for collision structure, visual identity, etc.
- The designers had a common understanding of the function structures.

G.2.4 TC-ON-04

Observations during DfAM and mapping lecture, 10th March 2022

- After the first function structures were created, a short lecture on AM and DfAM was organised before the mapping process could be introduced to the designers, as the designer had no previous experience with AM. During the lecture, the principle of AM and the steps of AM process were explained. The process of AM was also demonstrated on an FDM machine, where designers had an opportunity to observe the entire process. Different technologies of AM were mentioned, and the benefits and drawbacks of using AM were discussed. Next overview of DfAM was given during the lecture, with the emphasis on guidelines for designing polymer and metal AM parts. During the lecture, physical models of different AM parts and AM heuristics were shown to the designers. Designers had a chance to ask questions and showed a good level of understanding of what AM and DfAM are.
- Next, DPs for AM and the mapping method were introduced to the designers. This included showing the list of DPs and mapping rules, as well as a demonstration in the Function Mapping App of how to use and apply them. Designers understood the process and did not have any particular questions regarding the mapping process.
- The designers were instructed to map previously created function structures, if possible, in multiple combinations and create concepts based on the conducted mapping.

G.2.5 TC-ON-05

Observations after first mapping, 11th March 2022

- First mapping was conducted on three function structures. The suggested solutions were not clear and not fully applicable to the given context.
- The designers did not have a complete understanding of the suggested mapping rules and design principles.
- A few different errors in the application of mapping rules were noticed and brought to the attention of designers.
- Because the designers were not able to express the full functionality of the entire product with all its parts and components and use mapping methodology for generating concepts, the approach was changed from modelling the entire product to modelling its individual components.
- During a discussion with designers, 3 key functional subunits that can be translated to three components were identified, propulsion, chassis, and wheels. The functionality of the propulsion is to convert pneumatic energy to mechanical energy and transfer it onto the chassis. The function of the chassis is to transfer mechanical energy onto wheels and to resist impacts. The functionality of the wheels was to ensure the transfer of mechanical energy onto the surface. For each functional subunit, designers were able to create black-box models and define input and output flows.
- After identifying the three functional subunits, designers were instructed to create individual function structures for each subunit.

G.2.6 TC-ON-06

Observations of function modelling individual components, 11th & 14th March 2022

- Once the designers switched from function modelling of an entire system to function modelling of its parts (bottom-up approach), the process was fairly easy, and designers were able to quickly create the function structures for three subunits of the toy car.

- Designers showed a good understanding of the functionality of the subunits and had no problem expressing them through function structures.
- Once designers created separate function structures for the propulsion and the chassis, they gained a better understanding of their functionality and were able to combine them into a single function structure. Something they were not able to achieve when they were modelling the entire system (top-down approach).

| G.2.7 TC-ON-07

Observations of mapping individual components and concept generation, 15th – 17th March 2022

- The designers created four MFP Structures. The MFP Structures of the wheels were mapped with the same three MRs and differ only in one utilised DP. The MFP Structures of the chassis and the propulsion used a different set of MRs for mapping the function chain describing the flow of gas.
- Designers were satisfied with the overall MFP Structures. They were encouraged to iterate the function modelling and mapping process, but designers felt the current outputs were good.
- Designers created three concepts for the toy car. Concepts show the overall look of the toy car with few essential details but do not contain a comprehensive description. Furthermore, concepts embody AM based solutions, but their geometry could be manufacturable with other technologies with slight modifications.
- The lack of detailed elaboration of concepts could be attributed to the lack of experience, as designers did not have courses on product development in their education so far.

| G.3 Interview transcript 1

Interview conducted on 17th March 2022. The interview was conducted in Croatian, and the transcript was translated into English, with minor syntax corrections.

| G.3.1 TC-IN-01

Background information

Interviewer: Did you have any experience with function modelling before this project?

Designer C: *No.*

Interviewer: Did you have any experience with additive manufacturing before this project?

Designer C: *No.*

| G.3.2 TC-IN-02

FC Method

Interviewer: When you think back about the introductory lecture on function modelling using the Function Class approach, what was your impression about the approach? Did you understand the concept of Function Classes and the templates and rules provided during the lecture?

Designer C: *Yes, it seemed interesting. Everything was clear in the first example you showed us. All templates and rules are clear, and you just need to read them with understanding.*

Interviewer: What about the other examples that were shown during the lecture, where they also understandable?

Designer C: *Yes, everything was understandable.*

Interviewer: What was your experience using the Function Class modelling approach, including templates and rules? Were the vocabulary, FCs, and rules clear and understandable? What was your experience regarding the use of application for function modelling?

Designer C: *It was clear; however, some parts were a bit harder to comprehend as I had never encountered them before. The application was easy to use.*

Interviewer: Where there may be some issues in using Function Classes and application?

Designer C: *Maybe it was a bit limiting for our case as we tried to model an assembly, and there were some limitations in function modelling, as we wanted to implement some functionalities but didn't find an appropriate expression.*

Interviewer: Please describe your function modelling process from a logical point of view. What was your approach to the function modelling process? Please describe the way you created the function structure and highlight the difficulties you encountered and what you find helpful during function modelling.

Designer C: *Firstly, we added functions randomly, as we haven't thought through how the function structure should look like. This, of course, didn't work, so we tried to create a function structure for the entire assembly. Here we had interconnected function chains, and it didn't work. Later we managed to make function structures [when created at a part level].*

Interviewer: I notice you made paper notes and sketches of function structures, although you had the app at your disposal the entire time. What was the role of paper notes?

Designer C: *To note down ideas and go through them easily. That's because we saw the vocabulary for the first time, so we wrote down some functions in Croatian before searching them in the app.*

G.3.3 TC-IN-03

Mapping Method

Interviewer: When you think back about the lecture on methodology for mapping product functions with design principles for AM, what was your impression about the approach to find solutions that way? Did you understand the concept of mapping methodology and rules provided during the lecture?

Designer C: *That [the mapping process] was clear. The only problem was we already had some solutions in mind, which was not the point. But, generally speaking, everything was clear. When we applied the mapping for the first time, we randomly applied the rules, and that also didn't work. After additional clarification, everything was ok.*

Interviewer: What was your experience using tools for mapping product functions (rules and application)? Were the mapping rules clear and understandable?

Designer C: *In general, the rules were clear. There were some terms, like void structure, we didn't understand.*

Interviewer: Did you have issues with understanding when to apply which rule?

Designer C: *I think the rules description was clear.*

Interviewer: Were the design principles provided for the mapping process understandable? Were you able to comprehend the meaning of design principles and the meaning of AM possibilities they were referring to?

Designer C: *There were some principles we didn't understand, like all the different types of structures. I think as we didn't have experience with AM, some things from the description we couldn't understand what might be clear to someone who had some experience. There was a lot of new information we had to comprehend.*

Interviewer: Please describe your mapping process from a logical point of view. What was your approach to mapping? Please describe the way you created the mapped function structures and highlight the difficulties you encountered and what you found helpful during the mapping process.

Designer C: *First, we looked up the functions, then we searched possible mappings in the list, and that's how we mapped.*

Interviewer: Please describe your process of generating concepts using mapped function structures that were given to you. Could you describe how the mapping function structures influenced your approach to generating concepts? Please highlight the difficulties you encountered and what you find helpful during the concept generation process.

Designer C: *Firstly, we looked at the mapped function structures to see which possible solutions are suggested. Then we had a lot of discussions about these solutions. Then both added some ideas, and we got the overall solution in accordance with the mapped functions structure.*

Interviewer: What is your opinion about the solutions the mapping process suggested to you? Did you find the quality and broadness of suggested solutions adequate?

Designer C: *I think it [suggested solutions] could be expended. Maybe to look broader for potential solutions, as it was a bit limiting in the current form.*

Interviewer: Do you think the mapping process enabled you to achieve function integration (solving two or more functions with the same technical solution)? Please provide an example if possible.

Designer C: *Yes, for example, the airflow is made of multiple functions we solved with one solution, import gas, convert, guide gas, export gas, we solved all of these with a single mapping.*

| G.3.4 TC-IN-04

Other information

Interviewer: What is your opinion on using Function Modelling App? Was it a helpful tool for applying mapping methodology? Please highlight the difficulties you encountered and what you find helpful in using the Function Modelling App.

Designer C: *App was great. It was easy to use, and everything was clear.*

Interviewer: Do you have any additional comments or thoughts about the entire process of function modelling, mapping, and concept generation? Something that was helpful or something you didn't like, or something you would like to change?

Designer C: *I think the app can be improved, and it would be great to use it in some courses, as it would be interesting for the students.*

| G.4 Interview transcript 2

Interview conducted on 17th March 2022. The interview was conducted in Croatian, and the transcript was translated into English, with minor syntax corrections.

| G.4.1 TC-IN-05

Background information

Interviewer: Did you have any experience with function modelling before this project?

Designer D: *No.*

Interviewer: Did you have any experience with additive manufacturing before this project?

Designer D: *No, I have heard about it but not much more.*

| G.4.2 TC-IN-06

FC Method

Interviewer: When you think back about the introductory lecture on function modelling using the Function Class approach, what was your impression about the approach? Did you understand the concept of Function Classes and the templates and rules provided during the lecture?

Designer D: *At the beginning, it was a bit hard, as the first example [made in natural language] was broader in expression, and then we had to use verb + noun format and then it was a bit hard sometimes to express what we had in mind using only two words. But it was ok after we comprehended the style, but I'm not sure if every product could be expressed through these functions.*

Interviewer: What was your experience using the Function Class modelling approach, including templates and rules? Were the vocabulary, FCs, and rules clear and understandable? What was your experience regarding the use of application for function modelling?

Designer D: *Yes, everything was clear and understandable. I think it was very well defined and described.*

Interviewer: Please describe your function modelling process from a logical point of view. What was your approach to the function modelling process? Please describe the way you created the function structure and highlight the difficulties you encountered and what you find helpful during function modelling.

Designer D: *First time we looked at the product as an assembly, and we didn't catch that the toy car as a whole is one system. Also, at the beginning, we looked only at how the toy car should be powered, and later we added additional things like colour and signal. In the beginning, we didn't think about such functions. We firstly looked at physical aspects [of the system] connected with the motion.*

| G.4.3 TC-IN-07

Mapping Method

Interviewer: When you think back about the lecture on methodology for mapping product functions with design principles for AM, what was your impression about the approach to find solutions that way? Did you understand the concept of mapping methodology and rules provided during the lecture?

Designer D: *At first, no, I think we missed the point of mapping in our first attempt. But that was because, during function modelling, we didn't think about AM. And AM was something new to me, so the principles [in mapping] were not clear at first glance, as I was not familiar with the [technical AM] vocabulary and, moreover in English.*

Interviewer: What was your experience using tools for mapping product functions (rules and application)? Were the mapping rules clear and understandable?

Designer D: *Yes and no, we grasped the meaning, but it took as a bit more time then to understand them when we studied the materials for function modelling.*

Interviewer: Were the design principles provided for the mapping process understandable? Were you able to comprehend the meaning of design principles and the meaning of AM possibilities they were referring to?

Designer D: *Yes, I comprehended the meaning of principles. But I had a feeling that the principles were not broad enough, that we were limited by the suggested principles [during mapping process].*

Interviewer: Please describe your mapping process from a logical point of view. What was your approach to mapping? Please describe the way you created the mapped function structures

and highlight the difficulties you encountered and what you found helpful during the mapping process.

Designer D: *We started function by function and look which one [of suggested mapping rule] is the most suitable. In most cases, that was ok, but if we didn't have a good suggestion, we would put down our own comments. I personally didn't grasp mapping rules until they were suggested [by the app], then I was like, that makes sense. I can use this.*

Interviewer: Please describe your process of generating concepts using mapped function structures that were given to you. Could you describe how the mapping function structures influenced your approach to generating concepts? Please highlight the difficulties you encountered and what you find helpful during the concept generation process.

Designer D: *We tried to include every function. Maybe we focused a bit too much on detailing during conceptual design to ensure the toy car would move. But we tried to make everything compact and compatible with each other. Maybe at the beginning, I had one idea how everything should look like, but we saw there were other solutions as well.*

Interviewer: What is your opinion about the solutions the mapping process suggested to you? Did you find the quality and broadness of suggested solutions adequate?

Designer D: *I think more suggestions are needed. For example, we had a function chain with function Sense, but the only suggestion was related to the thermal energy, which we didn't have.*

Interviewer: Do you think the mapping process enabled you to achieve function integration (solving two or more functions with the same technical solution)? Please provide an example if possible.

Designer D: *Yes, for example, block of functions for the wheel. At first, our functions didn't look exactly like that, but then we changed it after we saw mapping rules.*

G.4.4 TC-IN-08

Other information

Interviewer: What is your opinion on using Function Modelling App? Was it a helpful tool for applying mapping methodology? Please highlight the difficulties you encountered and what you find helpful in using the Function Modelling App.

Designer D: *It was ok.*

Interviewer: Do you have any additional comments or thoughts about the entire process of function modelling, mapping, and concept generation? Something that was helpful or something you didn't like, or something you would like to change?

Designer D: *Include more colours for mapping.*

Appendix H

Case Study 4: Heat Exchanger

The following sections present data gathered in Case Study 4. First collected projected documents are presented. The project documents consist of function structures, mapped function structures, and concepts. For each document, a short description and figure are provided. Next, observation notes are presented, followed by interview transcripts.

H.1 Project documents

H.1.1 HE-PD-01

Initial function structures of heat exchanger

Figure H.1 shows two initial function structures the designer created for the heat exchanger. The top function chain (in both function structures) represents the primary flow of input fluid with thermal energy that is cooled by transferring the heat to the coolant (bottom function chain). Both function structures have errors in the graphical representation of flows as they do not follow the prescribed notation of input and output flows. The second function structure also contains the function *Convert TE to TE*, which is not in accordance with the laws of physics. The designer used this function to describe the residual flow of thermal energy in the primary flow.

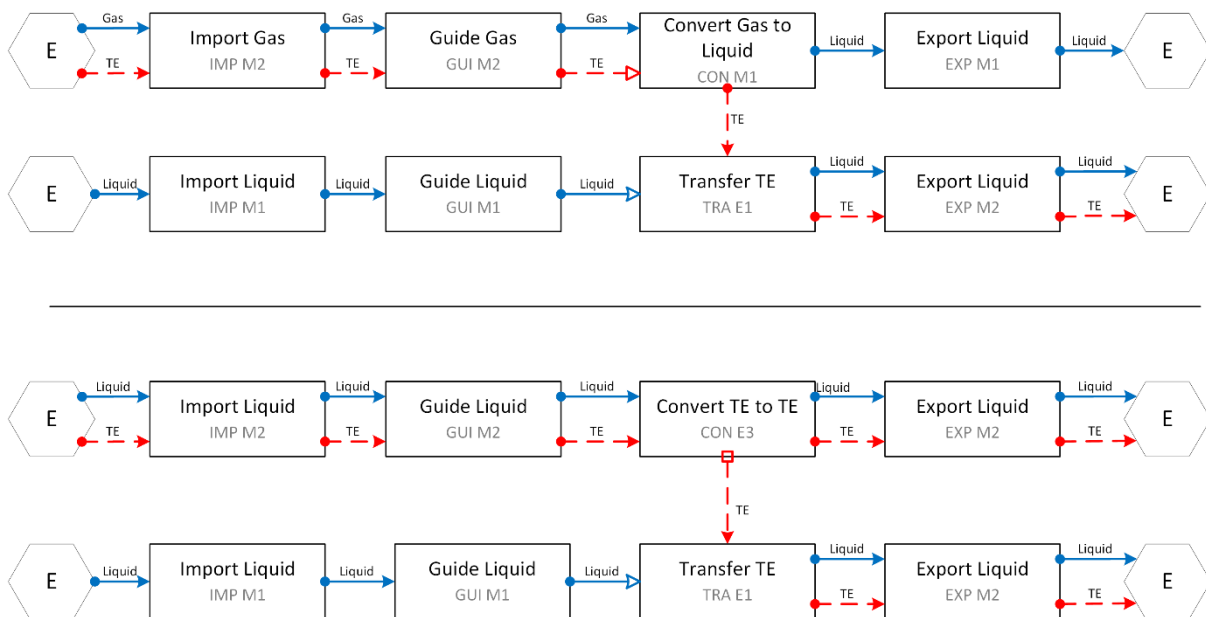

Figure H.1 Initial function structures of heat exchanger

H.1.2 HE-PD-02

Function structure of heat exchanger

Figure H.2 shows the final function structure of the heat exchanger. The function structure is in accordance with FC Method.

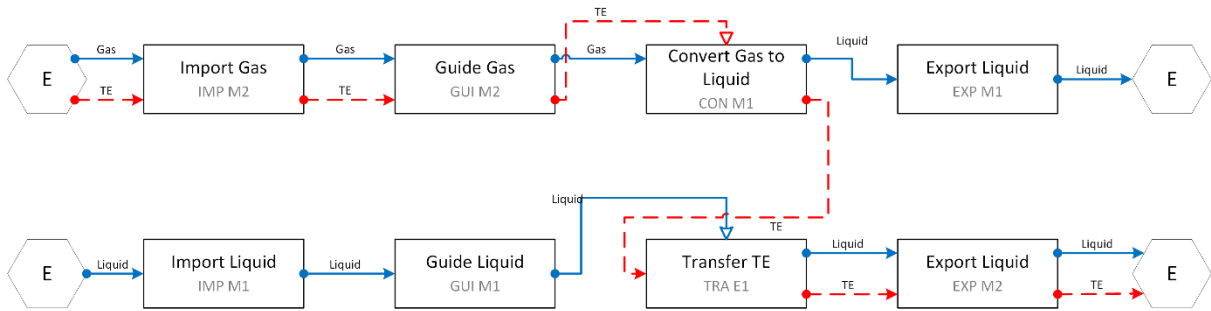

Figure H.2 Function structure of heat exchanger

H.1.3 HE-PD-03

Initial MFP Structure of heat exchanger

Figure H.3 shows the first MFP Structure designer created. The designer wrongly applied the MRs as he tried to map each function individually.

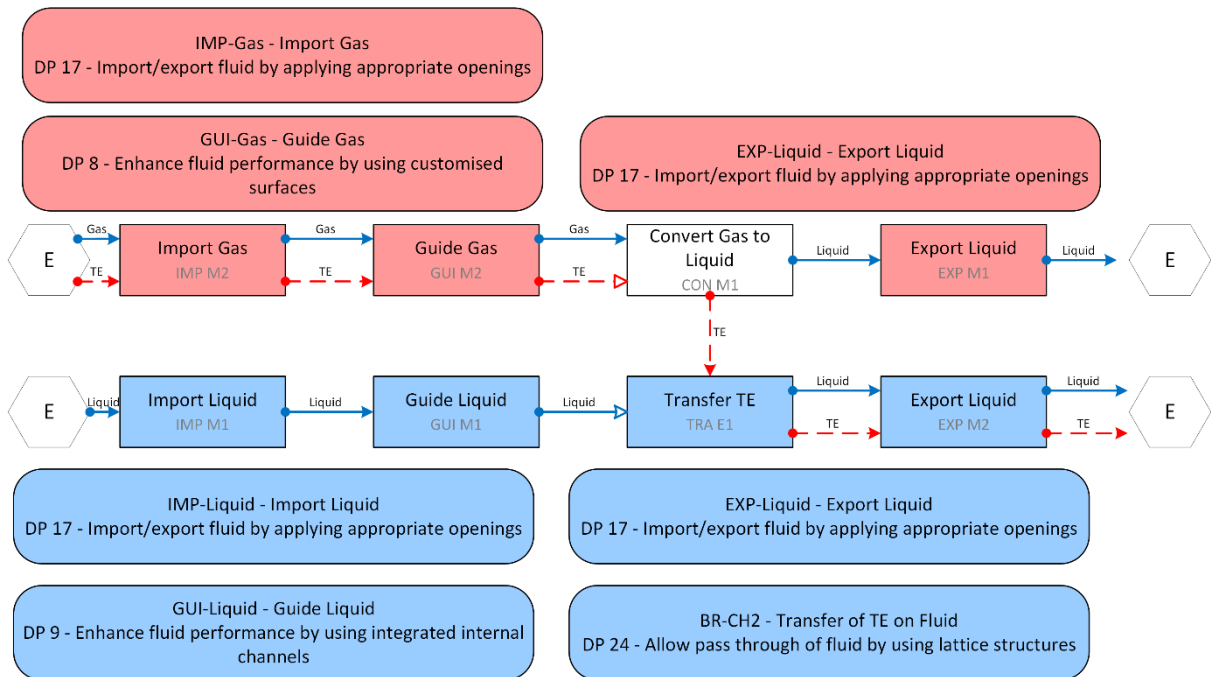

Figure H.3 Initial MFP Structure of heat exchanger

H.1.4 HE-PD-04

MFP Structure 1 of heat exchanger

The first MFP Structure (Figure H.4) is based on the HE-PD-02 function structure. It is mapped with 5 different MRs (6 in total) and utilises 3 different DPs. One function is unmapped.

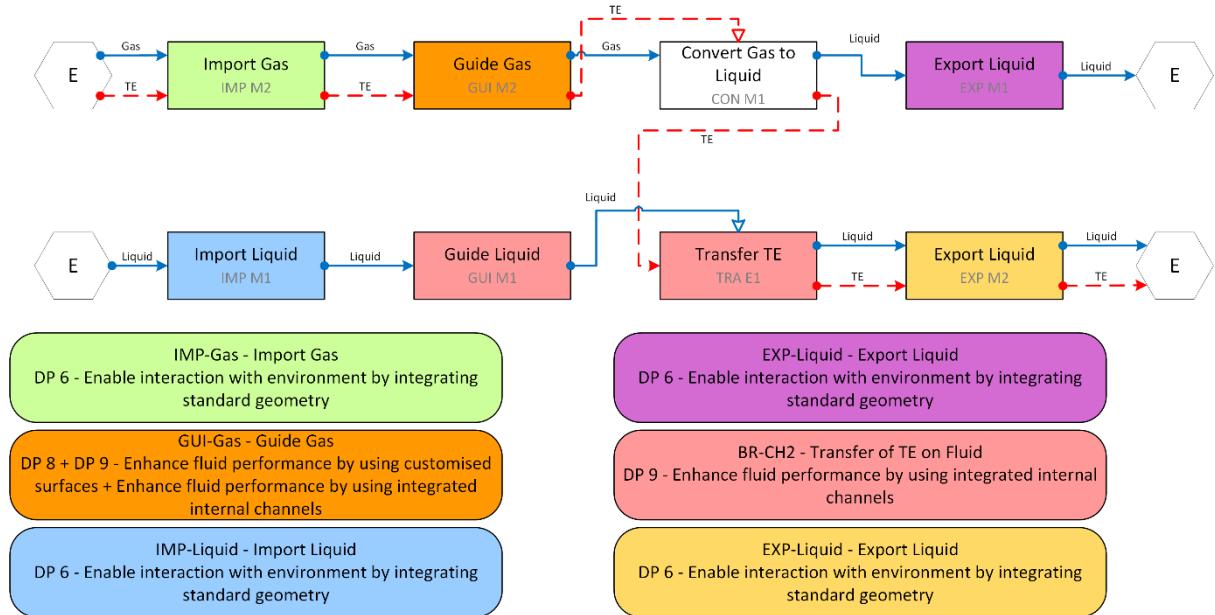

Figure H.4 MFP Structure 1 of heat exchanger

H.1.5 HE-PD-05

MFP Structure 2 of heat exchanger

The second MFP Structure (Figure H.5) is based on the HE-PD-02 function structure. It is mapped with 5 different MRs (6 in total) and utilises 4 different DPs. One function is unmapped.

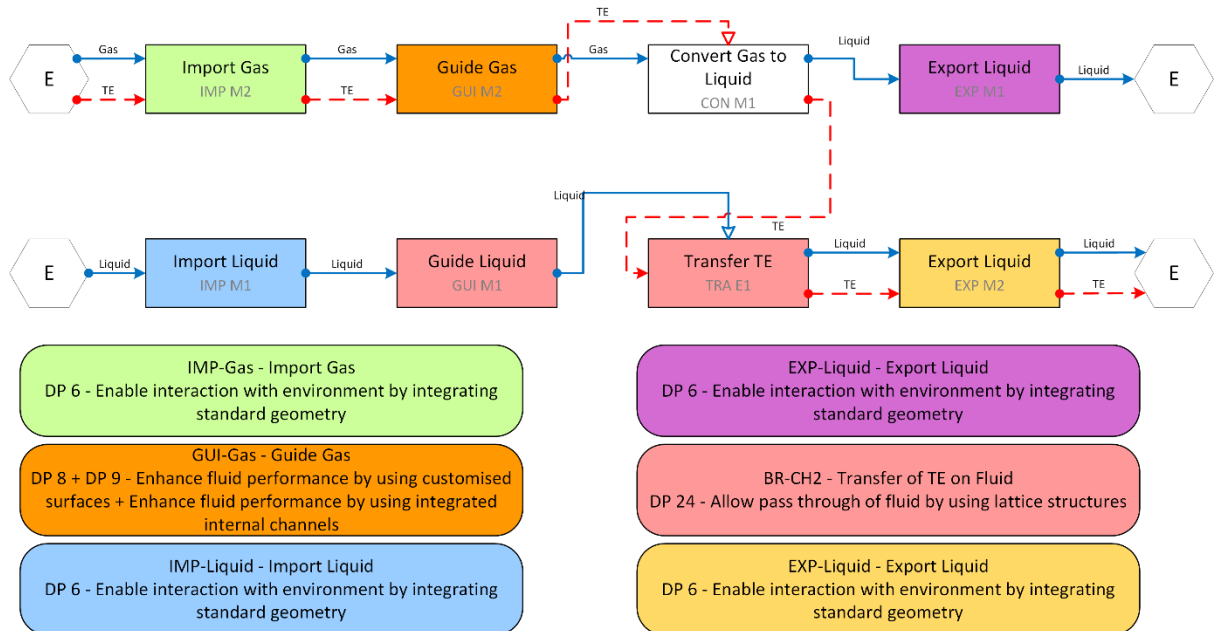

Figure H.5 MFP Structure 2 of heat exchanger

H.1.6 HE-PD-06

Concept 1

Steam enters the condensation (shell) chamber in which a hexagonal structure (cooling surface) is placed. Due to its large surface area, the hexagonal structure enables fast condensation of the steam. Condensate is gathered at the bottom of the chamber and exported through a pipeline to the boiler or secondary heat exchanger. The water (coolant) is imported into the secondary chamber (tube side) and is distributed into smaller channels integrated into the hexagonal structure separating the two chambers. The water takes away the heat and exports it outside the heat exchanger.

The dense alignment of the channels and good flow of coolant inside the hexagonal structure that increase the surface area enables better heat transfer and condensation than conventional shell and tube heat exchangers.

The main drawbacks of the concept are complicated geometry and the small diameter of the cooling channels that are prone to clogging and corrosion.

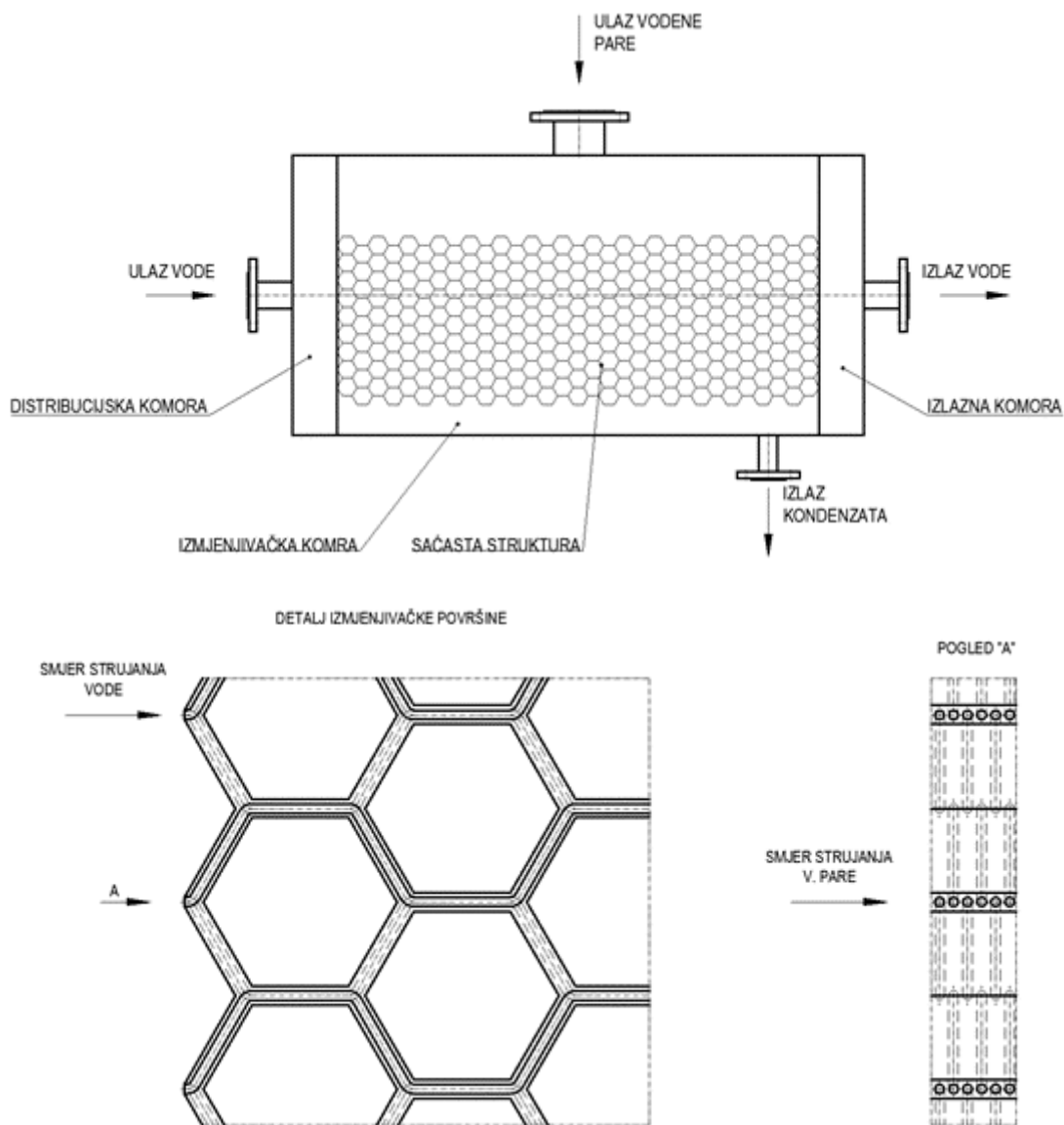

Figure H.6 Concept 1

H.1.7 HE-PD-07

Concept 2

Concept 2 uses the same principle as concept 1, with the difference being the cooling surface. In concept 2, the steam is imported into a condensation chamber in which a tube structure filled with coolant is placed. Tubes are connected with ribs to increase the cooling surface. The secondary chamber distributes coolant (water) into channels passing through the condensation chamber. The tubes are larger in diameter to avoid clogging the heat exchanger. Due to the larger diameter of the tubes, the deflectors are added to the tubes to increase the turbulent flow and increase the heat rate.

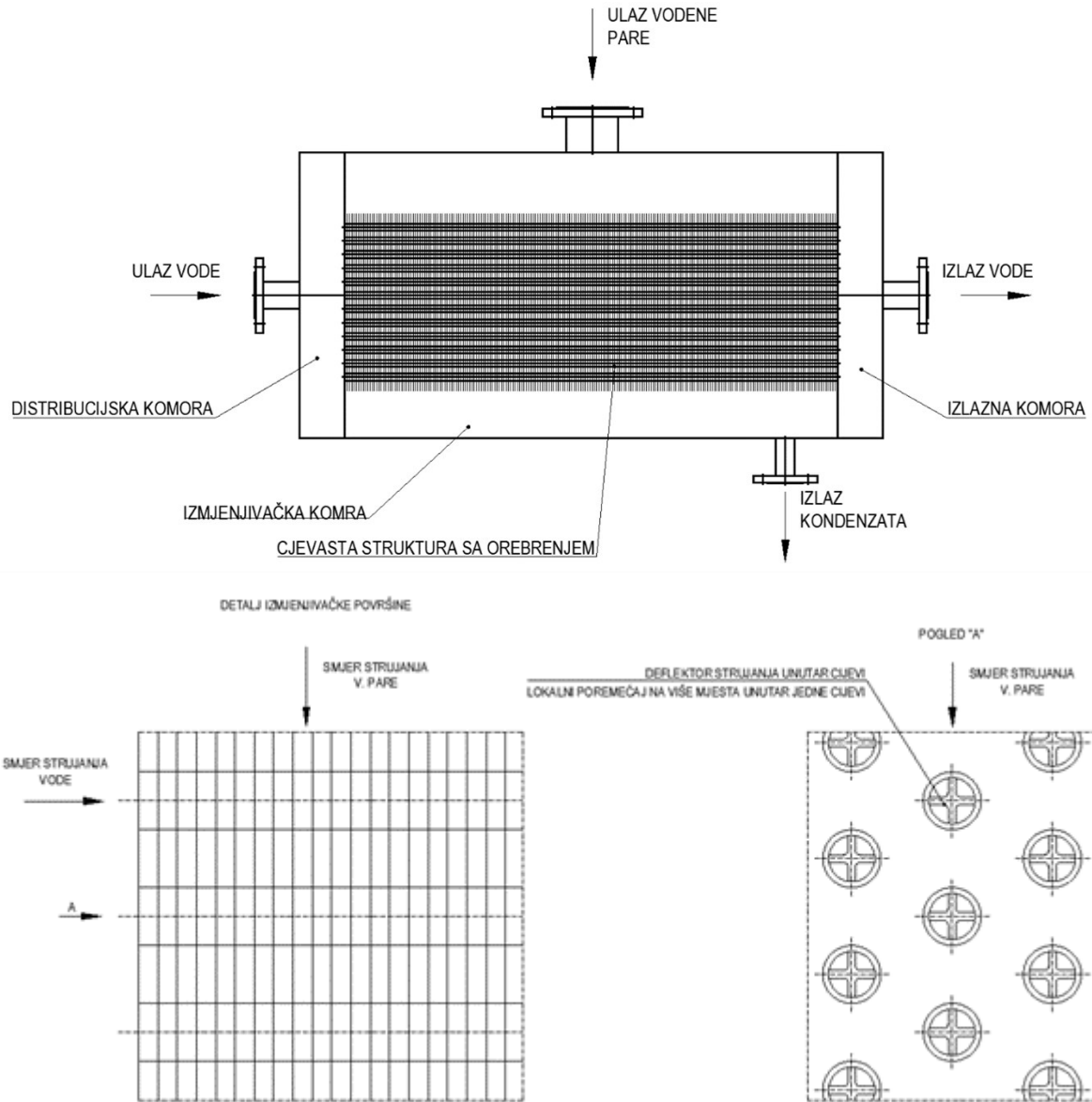

Figure H.7 Concept 2

| H.1.8 HE-PD-08

Statement

The heat exchanger is a piece of equipment for heat transfer from one fluid to another without the mixing of fluids. Part of the exchanger for the heat transfer must be made from material with a good rate of heat conduction and, at the same time, must be corrosion resistant and withstand pressure and heat stress depending on the environmental conditions. Heat exchangers must follow NN 79/16 regulation policy and Pressure Equipment Directive 2014/68/EU. Therefore, the heat exchangers have strictly defined design specifications, manufacturing process and testing process and are consequently made of simple design elements calculated using the appropriate norm (e.g., EN 13445, ASME, TEMA).

If the current regulations are ignored, additive manufacturing could provide new possibilities in the design of pressure equipment. The great design and manufacturing opportunities of specific surfaces provide new potential for the design of heat exchangers. However, due to current regulations and quality concerns, additive manufacturing is not applicable in the pressure equipment industry. Once the equipment manufacturers are able to guarantee the compact microstructure of the final product without inclusions and with guaranteed mechanical and heat properties, additive manufacturing will be a valuable manufacturing technology in the pressure equipment industry.

| H.2 Observation notes

| H.2.1 HE-ON-01

Project setup notes, January-February 2022

- The project was arranged with an industrial partner with the purpose of evaluating the conceptual design possibilities of AM for the processing industry.
- The project will be conducted by a single designer who has an extensive design experience in the development of processing equipment.

| H.2.2 HE-ON-02

Observations during methodology introduction, 10th March 2022

- Due to the availability of the industrial designer, all parts of the mapping methodology and application were introduced to the designer during one session.
- As the designer was already familiar with function modelling, it was only necessary to explain the vocabulary, FCs, and modelling rules to the designer. These elements were explained through one example of function structure that was modelled during the session as the modelling process was demonstrated in the FM App. The user interface and functions of the application were shown and explained simultaneously.
- The designer showed a good understanding of FCs approach during this session and modelling example. Additional five function structures shown in other case study projects were given to the designer for later review at one's convenience.
- After function modelling, the designer was introduced to the list of design principles, list of mapping rules and mapping methodology. While the designer does not have experience with using AM, due to his technical background, he understands the AM and its capabilities.
- The process of mapping function structures was explained and demonstrated in Function Mapping App.
- The designer showed a good understanding of the presented matter.

- The designer was instructed on how to conduct the task using the overall mapping methodology and was instructed to create concepts using the mapped function structures.
- At the end of the session, the designer raised his concerns that the products he designed are too simple for the design process he was just introduced to.

| H.2.3 HE-ON-03

Observations during first review, 20th March 2022

- The designer presented two structures he created and stated he was not able to model the residual flow of thermal energy after converting gas to liquid. Therefore, he tried to model it as Convert TE to TE, but he was not satisfied with the results.
- The designer was instructed to look at it as an ideal system in which the entire TE is transferred from one flow to another.
- Minor errors in modelling input and output flows were noted. When asked about it, the designer stated he forgot about the representation rules and just connected the flows in a way to avoid crossings to make it look tidy.
- The created MFP Structure was conducted by applying one MR per one function. When asked why he used such approach, designer stated he did not pay enough attention during lecture and thought the same procedure was used as in function modelling.
- The mapping procedure was once again explained and demonstrated through FM App, to the designer.

| H.2.4 HE-ON-04

Observations during second review, 23rd March 2022

- The designer showed a new version of a function structure, and it was fully compliant with FCs.
- The designer explained the function structure and showed he understood the FCs and could express the product functionality using the FC method.
- The new MFP structures were reviewed. The MRs and DPs are properly applied.
- The designer showed two concepts of the heat exchanger.

| H.3 Interview Transcript

Interview conducted on 23rd March 2022. The interview was conducted in Croatian, and the transcript was translated into English, with minor syntax corrections.

| H.3.1 HE-IN-01

Background information

Interviewer: Did you have any experience with function modelling before this project? If yes, please describe your previous experience with function modelling. What kind of function models did you create, for which products and how many?

Designer E: *Yes, I used function modelling during my studies. We modelled a pipe inspection device for nuclear power plants. It was part mounted on an existing system that had an inspection probe for scanning the inner wall of tubes in a heat exchanger.*

Interviewer: Did you have any experience with additive manufacturing and design for additive manufacturing before this project?

Designer E: *I don't have experience with AM. I'm mostly using semi-finished products [plates and tubes] that are positioned and welded together.*

H.3.2 HE-IN-02

FC Method

Interviewer: When you think back about the introductory lecture on function modelling using the Function Class approach, what was your impression about the approach? Did you understand the concept of Function Classes and the templates and rules provided during the lecture?

Designer E: *It was clear. I only used function modelling a few times before, and I don't use it in my development projects, as we usually jump directly on concepts of the product we need to develop. This was a school like approach, but it was clear, easy to use and could be quite useful.*

Interviewer: What was your experience using the Function Class modelling approach, including templates and rules? Were the vocabulary, FCs, and rules clear and understandable? What was your experience regarding the use of application for function modelling?

Designer E: *The templates are perfectly made. It clearly states the rules are that and that, functions are that and that, and they work fine. The application has some bugs but no issues with the use.*

Interviewer: Please describe your function modelling process from a logical point of view. What was your approach to the function modelling process? Please describe the way you created the function structure and highlight the difficulties you encountered and what you find helpful during function modelling.

Designer E: *Well, I was creating the function structure of a product I've been designing for a number of years. And I know what the simplest product must have, what is its function. It's a simple product, and it has only 2-3 functions.*

H.3.3 HE-IN-03

Mapping Method

Interviewer: When you think back about the lecture on methodology for mapping product functions with design principles for AM, what was your impression about the approach to find solutions that way? Did you understand the concept of mapping methodology and rules provided during the lecture?

Designer E: *At first, I was a bit lost, but I didn't use the mapping immediately after the lecture, but rather some ten days after. So, I first started mapping each function with one rule, and that didn't make any sense. Then I asked you for further clarification, and after that, it was quite easy to map.*

Interviewer: What was your experience using tools for mapping product functions (rules and application)? Were the mapping rules clear and understandable?

Designer E: *App was ok. It was easy to use the rules. They were clear and understandable.*

Interviewer: Were the design principles provided for the mapping process understandable? Were you able to comprehend the meaning of design principles and the meaning of AM possibilities they were referring to?

Designer E: *Yes.*

Interviewer: Please describe your mapping process from a logical point of view. What was your approach to mapping? Please describe the way you created the mapped function structures and highlight the difficulties you encountered and what you found helpful during the mapping process.

Designer E: *Logic was that you need to ensure input and output, and for that, you know you need some standard elements. Then the things in between must be mapped. It [the mapping] was mostly sequential.*

Interviewer: Please describe your process of generating concepts using mapped function structures that were given to you. Could you describe how the mapping function structures

influenced your approach to generating concepts? Please highlight the difficulties you encountered and what you find helpful during the concept generation process.

Designer E: *To be honest, I already had a concept in my head ever since I had to think about AM and the complex shapes it enables. I didn't have to use simple shapes like pipes but could combine more different shapes into one part, so I haven't used mapped function structure much.*

Interviewer: What is your opinion about solutions the mapping process suggested to you? Did you find the quality and broadness of suggested solutions adequate?

Designer E: *The application [mapping methodology & DP] is still under development. It has some interesting solutions. In some aspect I would like it [the solutions] to be more generalised and not focused. There is an opportunity for further improvements.*

Interviewer: Do you think the mapping process enabled you to achieve function integration (solving two or more functions with the same technical solution)? Please provide an example if possible.

Designer E: *Yes, import fluid and transfer of heat you solve using internal channels.*

| H.3.4 HE-IN-04

Other Information

Interviewer: What is your opinion on using Function Modelling App? Was it a helpful tool for applying mapping methodology? Please highlight the difficulties you encountered and what you find helpful in using the Function Modelling App.

Designer E: *In principle, you can use the app without all the paper materials. It's intuitive, you click, and you find a solution. Everything is described in detail enough in the app, so the additional paper materials were not necessary.*

Interviewer: Do you have any additional comments or thoughts about the entire process of function modelling, mapping, and concept generation? Something that was helpful or something you didn't like, or something you would like to change?

Designer E: *It takes some time to get familiar with the logic that when one flow of energy enters the system, all energy is transferred. Maybe it would be technically more precise that there is always some [flow of] energy you can't utilise. In [function] Transfer Energy, you can't transfer all of it, and you would need two output flows.*