

# Ocjena radnog opterećenja pilota helikoptera za scenarij slijetanja na brodsku platformu

---

Gašparac, Tibor

Master's thesis / Diplomski rad

2019

*Degree Grantor / Ustanova koja je dodijelila akademski / stručni stupanj:* **University of Zagreb, Faculty of Mechanical Engineering and Naval Architecture / Sveučilište u Zagrebu, Fakultet strojarstva i brodogradnje**

*Permanent link / Trajna poveznica:* <https://urn.nsk.hr/urn:nbn:hr:235:444155>

*Rights / Prava:* [In copyright](#)/[Zaštićeno autorskim pravom.](#)

*Download date / Datum preuzimanja:* **2024-07-15**

*Repository / Repozitorij:*

[Repository of Faculty of Mechanical Engineering and Naval Architecture University of Zagreb](#)



UNIVERSITY OF ZAGREB  
FACULTY OF MECHANICAL ENGINEERING AND NAVAL  
ARCHITECTURE

# **MASTER'S THESIS**

Tibor Gašparac

Zagreb, 2019.

UNIVERSITY OF ZAGREB  
FACULTY OF MECHANICAL ENGINEERING AND NAVAL  
ARCHITECTURE

# MASTER'S THESIS

ASSESSMENT OF THE PILOT WORKLOAD DURING THE  
HELICOPTER SHIP DECK LANDING SCENARIO

Mentor:

Prof. dr. sc. Milan Vrdoljak, dipl. ing.

Student:

Tibor Gašparac

Zagreb, 2019.

*In memory of my friend Patrik Blaško, who gave his best to inspire me to become  
the person I am today.*

*First of all, I would like to express my gratitude and appreciation to my University professor, Prof.dr. Milan Vrdoljak for his enormous efforts to introduce me to the aerospace engineering world and for providing his support, time and patience during my university years to expand my knowledge.. I would also like to thank Prof.dr. Vrdoljak for showing faith in me and giving me a chance to write my Master's Thesis at the Technical University of Munich, guiding me all the way through the process and always finding time to provide assistance.*

*Also, I also want to express my endless gratitude to my mentor at the Technical University of Munich, a friend and a colleague, Mr. Tim Oliver Mehling, for his enormous support, guidance, selflessness and kindness, both professionally and privately. A great thanks for all the days and hours spent with me at the simulator, for every of your emails responded within an hour, your efforts to make my stay easier and for being there at the very beginning of my professional career providing me with advices and experience. Special acknowledgements go to Prof. dr. Manfred Hajek for ensuring me the access to the simulator and all the equipment used for experiment, as well as to Mr. Omkar Halbe and Mr. Jakob Bludau for their professional assistance during our work on HELIOP project and to all TUM staff volunteering in our experiments.*

*An enormous and most special "Thank you" goes to my friend before anything else, my fiercest supporter and my future life-companion, Mrs. Ela Tomljanović for her unmatched encouragement, faith, support and unconditional love through my hardest moments during my stay in Munich, endless patience, time and calmness without which my whole stay in Munich would be unimaginably harder. Thank you for every moment spent on video-calls and every late night spent waiting for me at the bus station.*

*I am very grateful to all of my loving friends and colleagues with whom I shared my university days and finally, I am endlessly grateful to my parents Goran and Tamara, without whom I would not be and I hope I am making you proud.*

*I hereby declare that I have made this thesis independently using the knowledge acquired during my studies and the cited references.*

*Izjavljujem da sam ovaj rad izradio samostalno koristeći znanja stečena tijekom studija i navedenu literaturu.*

*Zagreb, May 2019*

*Tibor Gašparac*



Sveučilište u Zagrebu Fakultet strojarstva i brodogradnje	
Datum	Prilog
Klasa:	
Ur.broj:	

## DIPLOMSKI ZADATAK

Student: **Tibor Gašparac** Mat. br.: 0035195490

Naslov rada na hrvatskom jeziku: **Ocjena radnog opterećenja pilota helikoptera za scenarij slijetanja na brodsku platformu**  
Naslov rada na engleskom jeziku: **Assesment of the pilot workload during the helicopter shipdeck landing scenario**  
Opis zadatka:

Ocjena radnog opterećenja pilota, poput ocjene kvalitete upravljanja uobičajeno se provodi u letu za određenu zadaću elementa misije (engl. mission task element, MTE), no iste ocjene moguće je provesti i na simulatoru leta uz određene korelacije između rezultata. Takvi eksperimenti na simulatoru značajno su jeftiniji, jednostavnije implementacije različitih varijanti promatrane MTE i letjelice (poput npr. izgled prikaznika pilota ili značajki sustava upravljanja), a kao takvi koriste se i za pripremu eksperimentalnog leta na stvarnom zrakoplovu. Ocjena radnog opterećenja pilota može biti objektivna temeljem određenih mjerljivih značajki leta i subjektivna temeljem ocjene pilota. Za subjektivnu ocjenu radnog opterećenja pilota uobičajena je primjena Bedfordove skale temeljem upitnika kojima pilot nakon leta ocjenjuje provedbu analizirane MTE.

Simulator na kojem je moguće provesti takvu analizu je Rotorcraft Simulation Environment - ROSIE smješten na Institute for Helicopter Technology, Department of Mechanical Engineering, Technical University of Munich (TUM). Za diplomski rad od interesa je promatrati odabrane MTE za scenarij slijetanja helikoptera na brodsku platformu u okviru TUM projekta HELIOP.

U okviru diplomskog rada potrebno je:

- opisati simulator leta helikoptera ROSIE,
- opisati i implementirati podatke o gibanju brodske platforme helidroma u simulator ROSIE,
- pripremiti proceduru provedbe eksperimenta na simulatoru i upitnike za subjektivnu analizu radnog opterećenja pilota za odabrane zadaće elemenata misije,
- provesti eksperiment na simulatoru za odabrane MTE,
- analizirati rezultate eksperimenta sa simulatora.

U radu je potrebno navesti korištenu literaturu i eventualno dobivenu pomoć.

Zadatak zadan: Rok predaje rada: Predviđeni datumi obrane:  
7. ožujka 2019. 9. svibnja 2019. 15., 16. i 17. svibnja 2019.  
Zadatak zadao: Predsjednik Povjerenstva:

Prof. dr. sc. Milan Vrdoljak

Prof. dr. sc. Milan Vrdoljak

## TABLE OF CONTENTS

PROŠIRENI SAŽETAK .....	VIII
1 INTRODUCTION.....	1
1.1 Challenges of helicopter ship deck landing operations .....	1
1.2 Civil and military maritime helicopter operations.....	4
1.3 Connection to the TUM HELIOP project and approach to the problem.....	6
2 SYSYEMATIC CHARACTERIZATION OF NAVAL ENVIRONMENT DATABASE.....	10
2.1 Specification and implementation of the SCONE database .....	10
2.2 Description of coordinate systems used within the SCONE database .....	13
2.3 SCONE Data Description.....	14
2.4 Definition of the rotation angles and rotation matrix .....	15
3 INTEGRATION OF SCONE DATABASE TO ROSIE.....	16
3.1 Transferring the SCONE database in MATLAB .....	16
3.2 SCONE Simulink subsystem.....	19
4 PILOT WORKLOAD ASSESSMENT OF THE SIMULATED SHIP DECK LANDING PROCEDURE .....	24
4.1 Experiment overview – „Human-in-the-loop“ simulation .....	24
4.2 Pilot workload research hypotheses .....	25
4.3 Flight trials procedure .....	26
4.3.1 Input forcing function signal .....	31
4.3.2 Primary flight display setup.....	32
4.4 Quantitative analysis – subjective workload assessment .....	35
4.4.1 Pilot workload rating questionnaire.....	35
4.4.2 Attitude direction indicator (ADI) coloring questionnaire .....	40
4.4.3 Simulator sickness questionnaire .....	42
4.4.4 Biography questionnaire.....	44
5 FLIGHT TEST EXPERIMENT RESULTS.....	45
5.1 Subjective workload assessment results for Visual reference and Commanded roll task elements.....	45
5.2 Simulator Sickness Questionnaire (SSQ) results.....	48
5.3 Subjective workload assessment results for the Task element: Landing.....	50
5.4 Preference between the PFD and HMD for the mission task elements.....	52
5.5 Flight test data objective analysis.....	56
6 CONCLUSION .....	63
7 LITERATURE .....	65



## LIST OF FIGURES

Figure 1	Helicopter approaching to the ship deck [3].....	2
Figure 2	AH-64E helicopter landing on the USS Peleliu aircraft carrier [4].....	3
Figure 3	Search and rescue helicopter on a demanding evacuation mission [3] .....	5
Figure 4	Exterior view on a flight simulator connected to ROSIE at Technical University of Munich [6] .....	6
Figure 5	ROSIE projection plane [6] .....	7
Figure 6	ROSIE architecture design [6].....	8
Figure 7	The original Bo105 cockpit for the pilots [6] .....	9
Figure 8	Digital terrain model used as simulation environment [6] .....	9
Figure 9	The USS Arley Burke class destroyer (DDG-51 type) with a helicopter landing spot [12]. .....	10
Figure 10	2D SCONE ship model hull geometry with the reference point ("Center of Gravity") [7] 11	11
Figure 11	Graphical representation of the ship's coordinate system [8] .....	14
Figure 12	SCONE database files imported to Matlab software .....	16
Figure 13	Graphical explanation of the SCONE database file nomenclature.....	17
Figure 14	Graphical comparison of different roll intensity levels found within the SCONE database .....	18
Figure 15	Graphical comparison of different heave intensity levels found within the SCONE database .....	18
Figure 16	Simulink model of the SCONE database - top level architecture view.....	19
Figure 17	Simulink model of the SCONE database architecture - implementation of the random wave phase cases.....	20
Figure 18	Simulink model of the SCONE database - motion data and motion prediction data ....	21
Figure 19	Decomposition of the "Basic Motion data" Simulink subsystem.....	22
Figure 20	Decomposition of the "Motion prediction data" Simulink subsystem .....	22
Figure 21	Simulink SCONE database signal selection user interface .....	23
Figure 22	Experimental display design for Primary Flight Display (PFD) and Helmet Mounted Display (HMD).....	27
Figure 23	Straight in approach to the ship deck [16].....	28
Figure 24	ADS-33 landing platform .....	29
Figure 25	ROSIE visualization of DDG-51 type ship, rotorcraft landing deck.....	30
Figure 26	Input forcing function general form [15].....	31
Figure 27	Input forcing function signal used for the commanded roll flight test experiments [15].. .....	31
Figure 28	Primary flight display used for the experiment .....	32
Figure 29	PFD attitude director indicator (ADI) with explanation.....	33
Figure 30	HMD attitude direction indicator (HMD ADI) with explanation.....	34
Figure 31	Bedford workload rating scale [20].....	35
Figure 32	A rating scale developed for the purposes of the HELIOP project flight test analysis .	36
Figure 33	Rating scale developed for the HELIOP project PFD vs. HMD pilot preference .....	37
Figure 34	Simulator sickness questionnaire (SSQ) [22].....	43
Figure 35	Pilot workload rating assessment for the Task elements 1.1, 1.2, 1.3, 2.1 and 3.1 .....	45
Figure 36	Simulator experiment with a pilot-in-the-loop in a Mission Task Element: Commanded roll PFD .....	47
Figure 37	Simulator Sickness Questionnaire results (1st part) .....	48
Figure 38	Simulator Sickness Questionnaire results (part 2).....	49
Figure 39	Subjective workload assessment results for the Task element: Landing.....	50

---

Figure 40	Preference between the PFD ADI and HMD ADI for the Task Element: Commanded roll .....	53
Figure 41	Additional PFD vs. HMD ADI coloring questionnaire .....	54
Figure 42	Example of the flight test recording data for task elements including commanded roll	56
Figure 43	Error variance comparison between PFD and HMD mission task elements for commanded roll.....	57
Figure 44	Actual vs. commanded roll comparison of the recorded data for the lowest and highest error variance flight recordings using the PFD .....	59
Figure 45	A detail from the Task element roll <i>PFD</i> , red line stressing out the effect of counter intuitive lateral command.....	59
Figure 46	Actual vs. commanded roll comparison of the recorded data for the lowest and highest error variance flight recordings using the PFD .....	60
Figure 47	Cyclic stick lateral and longitudinal activity recording for the landing scenarios of ADS-33 and ship deck landing.....	61

**LIST OF TABLES**

Table 1 Principal dimensions and hull characteristics of the SCONE ship model ..... 11  
Table 2 SCONE data description ..... 12  
Table 3 Pilot workload rating questionnaire with all mission task elements ..... 38  
Table 4 Attitude direction indicator (ADI) coloring questionnaire ..... 41

**List of symbols**

$B$	beam, maximum, [ft]
$B_{WL}$	beam, waterline, [ft]
$DOF$	degree of freedom
$GM_T$	metacentric height, [ft]
$LCG$	longitudinal center of gravity, [ft]
$LOA$	length, overall, [ft]
$L_{WL}$	length, waterline, [ft]
$T$	draft, baseline, [ft]
$T_{max}$	draft, maximum, [ft]
$V$	displaced volume, [ft <sup>3</sup> ]
$VCG$	vertical center of gravity, [ft]
$\mathbf{r}_{global}$	position vector of a point in global coordinates, [ft]
$\mathbf{r}_{static}$	Position vector of a point in initial (SCONE database) static coordinates, [ft]
$\mathbf{Rd}_{global}$	Position vector of a ship deck reference point in global coordinates, [ft]
$\mathbf{Rd}_{static}$	Position vector of a ship deck reference point in initial coordinates, [ft]
$\phi$	ship roll attitude, [°]
$\psi$	ship pitch attitude, [°]
$\theta$	ship heave attitude, [°]
$\Phi_h$	helicopter roll angle, [°]

## SAŽETAK

Slijetanje helikoptera na brodsku platformu predviđenu za takvu misiju, veoma je zahtjevan zadatak za pilote budući da se pri slijetanju moraju uzeti u obzir nasumične kretnje broda na valovima, degradirani vizualni uvjeti i turbulencije struje zraka sa rotora koja nailazi na brodsku platformu. Slijetanje helikoptera na brodsku platformu izvodi se u raznim slučajevima kao na primjer u operacijama spašavanja, prisilnog slijetanja zbog eventualnih kvarova iznad helikoptera iznad vode, vojnim operacijama, edukaciji pilota helikoptera kao i mnogim drugim. Iz tog razloga, motivacija za ovaj diplomski rad upravo je simulacija slijetanja helikoptera na brodsku platformu. Kao alat za provedbu ove simulacije koristit će simulator leta helikoptera (Rotorcraft Simulation Environment) smješten na Tehničkom Sveučilištu u Minhenu. Kako bi se kretnje broda u nastavku projekta mogle implementirati, potrebno je modelirati brod opisan kasnije u diplomskom radu, sa središtem koordinatnog sustava u središtu platforme za slijetanje helikoptera. Baza podataka koja sadrži informacije o nasumičnim kretanjama broda na površini vode preuzeta je iz Systematic Characterization Of the Naval Environment (SCONE) projekta, čiji su podaci dobiveni simulacijom kretanja brodske palube broda tipa DDG-51 korvete. U bazi podataka dostupne su informacije o gibanju broda u svih šest stupnjeva slobode. Glavna zadaća ovog diplomskog zadatka koji je dio Helicopter Ship Deck Operations (HELIOP) projekta je integracija SCONE baze podataka u sam ROSIE simulator koristeći programske pakete Matlab i Simulink, te povezivanje sa postojećim sustavom za simulaciju leta helikoptera. Nakon implementacije podataka o kretanju broda u sam simulator, organizirati će se testni letovi u kojima će se proučavati polu-autonomno i ručno slijetanje helikoptera na brod. Svrha testova je subjektivna i objektivna kvantitativna procjena intenziteta radnog opterećenja koji pilot ulaže prilikom slijetanja, te usporedba istog u različitim slučajevima. Kako bi se provela analiza, osmišljeni su specifični upitnici sa usmjerenim pitanjima na temelju kojih će se prikupiti podaci za usporedbu. Objektivna procjena radnog opterećenja promatrat će se također sa objektivnog stajališta, analizirajući pokrete pilotske upravljačke palice u različitim slučajevima.

Ključne riječi: simulator leta helikoptera, slijetanje helikoptera na brodsku platformu, SCONE, procjena radnog opterećenje pilota, simulacija s pilotom u petlji, HELIOP

## **SUMMARY**

Helicopter landing on a ship deck is a challenging task due to increased pilot workload while dealing with random ship motion and effects like ship air wake turbulence. There are numerous occasions where the helicopter ship deck landing could be necessary like naval rescue operations, forced landing over the sea due to possible helicopter system failures, military operations and exercises, helicopter pilot training. For that matter, this master's thesis deals with the simulated ship deck landing scenario. A six degrees of freedom Rotorcraft Simulator Environment (ROSIE) which is situated at the Technical University of Munich (TUM) will be used as a tool to execute the simulation. For that purpose, it was necessary to build a completely new ship model with the coordinate system origin in the center of the ship deck, so the motion data can be implemented later. Afterwards, a realistic ship deck landing simulation scenario could be successfully executed. The movement data which will be implemented is acquired from the Systematic Characterization of the Naval Environment (SCONE) project database and the data is provided for simulated deck motion using a state-of-the-art non-linear seakeeping prediction code (LAMP). Files from the database include a full, consistent set of six degrees of freedom ship deck motion data for a generic surface combatant ship (DTMB Model 5415 hull) which is a representative of a DDG-51 type ship. The main object of this thesis inside the HELIOP project is to integrate the SCONE database as a single Simulink block to the ROSIE environment which is simulated by MATLAB files with a flight model based on recorded data. After the data implementation, integration to the graphical interface, flight test campaigns will be defined for the helicopter ship deck landing in manual and guided mode scenarios. The focus of the flight campaigns will be put on subjective and objective quantitative analysis in terms of required pilot workload during the landing phase. Specific set of questionnaires for the pilots will be presented and used to help with the subjective workload assessment. The objective workload assessment will be conducted by analyzing the cyclic stick input data in different landing scenarios.

Key words: helicopter ship deck landing, "pilot-in-the-loop simulation", SCONE, subjective workload assessment, HELIOP

## PROŠIRENI SAŽETAK

Slijetanje helikoptera na brodsku platformu smatra se jednim od najzahtjevnijih manevara u letu helikoptera budući da pilot prilikom slijetanja mora voditi računa o nekoliko faktora koji utječu na slijetanje kao što su nasumične kretnje broda uzrokovane strujama ili naletima vjetra i turbulencijama visokog intenziteta uzrokovanih strujom zraka sa rotora helikoptera koji nailaze na površinu brodske platforme. Uz to se također u velikom broju slučajeva slijetanje helikoptera na brod izvodi dok je brod u pokretu, dok su vizualni uvjeti često degradirani.

Kroz povijest, a i u današnje vrijeme, helikopteri su se pokazali veoma korisnim u provođenju operacija osiguravanja sigurnosti na kopnu, kao i na moru zahvaljujući svojoj fleksibilnosti i mogućnosti da zadovolje operativne zahtjeve u raznim zahtjevnim uvjetima. Neke od misija koje su jedinstvene za helikoptere u morskom okruženju uključuju misije traganja i spašavanja, misije evakuacije putnika sa brodova, izvidničke misije, protu-podmorničke misije, prijevoz osoblja na *offshore* objekte i mnoge druge.



**Slika 1** Helikopter u prilazu offshore objektu

Međutim, uzevši u obzir sve prednosti helikoptera u prethodno opisanim misijama, smatra se da će helikopteri igrati veliku ulogu u budućnosti kao sredstvo za prijevoz civilnih putnika u svrhu mobilnosti u urbanom zračnom prijevozu. Ideja je omogućavanje samostalnog putničkog zračnog prijevoza do željenog cilja, gdje će putnici biti u mogućnosti upravljati helikopterom uz određeni stupanj asistencije od strane automatiziranog sustava upravljanja integriranog u letjelicu. Upravo je to jedan od smjerova istraživanja Helicopter Shipdeck Operations (HELIOP) projekta formiranog na Katedri za helikoptere Tehničkog sveučilišta u Minhenu (Technical University of Munich) s fokusom na istraživanja vezana na utjecaj zone slijetanja na performanse pilota, degradirane vizualne uvjete prilikom slijetanja i polijetanja i mnoga druga. Za potrebe istraživanja na HELIOP projektu koristi se ROSIE (Rotorcraft Simulation Environment) simulator sa pilotom u povratnoj petlji (engl., “pilot-in-the-loop”) modela helikoptera Bo-105 u kombinaciji sa GENSIM simulacijskim modelom. U sklopu HELIOP projekta i prethodno opisanih istraživanja, ovaj diplomski rad fokusiran je na istraživanje mogućnosti neprofesionalnih pilota helikoptera da slete na brodsku palubu vođeni signalima prikazanim na instrumentima unutar pilotske kabine ili na prikazniku na kacigi (eng., „Head Mounted Display“, HMD) što će detaljnije biti opisano u nastavku teksta.



**Slika 2** Kokpit simulatora helikopter smještenog na Katedri za helikoptere Tehničkog fakulteta u Minhenu



Kako bi se napravila osnova za daljnji napredak HELIOP projekta u ispitivanju mogućnosti slijetanja na brodsku palubu u pokretu, u virtualno okruženje simulatora je integriran statički 3D-model američkog broda tipa DDG-51 koji spada u klasu razarača koristeći Open Scene Graph i Microsoft Visual Studio softverske pakete. Budući da je na simulatoru moguća simulacija leta iznad područja Njemačke, brod je, zbog jednostavnosti smješten u jezero Tegernsee. Kako bi simulacija u budućim ispitivanjima bila što realnija, jedan od zadataka ovog diplomskog rada bila je realizacija simulacije slijetanja sa 3D-modelom broda u pokretu. Budući da na simulatoru u vrijeme izrade ovog diplomskog rada nije postojao model valova, već je fluid na kojem je brod smješten prikazan izričito kao statički ravna površina, izrada 6-DOF (stupnjeva slobode gibanja) smatrala se nepoželjnom, pa je kao alternativa nađeno drugačije, inženjerski jednostavnije rješenje za taj problem. Na temelju rezultata SCONE (System Characterization of the Naval Environment) projekta, prikupljeni su snimljeni podaci o nasumičnim kretanjama broda klase DDG-51 razarača u trajanju od 30 minuta koji sadrže informacije o translaciji, rotaciji, brzini i ubrzanju oko sve tri osi fiksnog Kartezijevog koordinatnog sustava sa ishodištem na središtu površine brodske platforme za slijetanje helikoptera. Na temelju tih podataka, u softverskom paketu Simulink kreirana je baza podataka spremna za implementaciju i odabir između nekoliko različitih scenarija kretanja broda od kojih u svakom scenariju intenzitet u jednom stupnju slobode gibanja dominira nad ostalima.

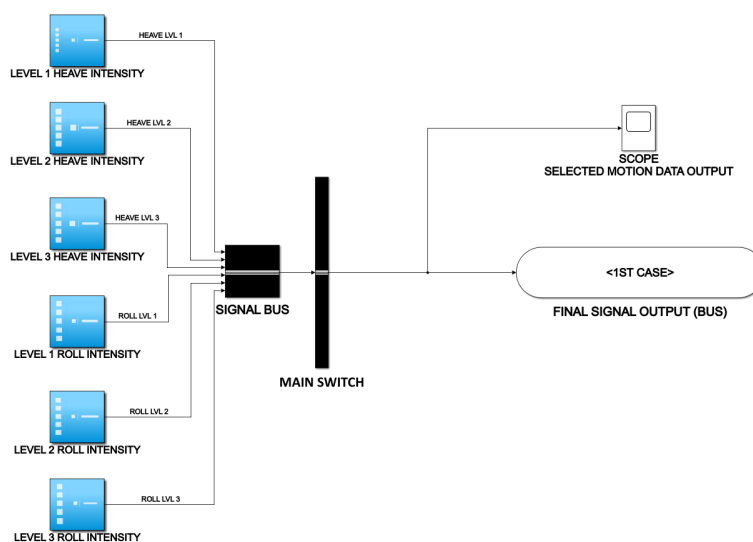

**Slika 3** Detalj iz Simulink modela SCONE baze podataka

Iako je model kretanja broda na temelju snimljenih podataka iz SCONE baze podataka pripremljen i spreman za grafičku implementaciju, u ovom diplomskom radu odlučeno je kako je potrebno napraviti pripremu za analizu slijetanja na brod u pokretu. Zato je odlučeno kako će testovi koji će se analizirati u nastavku ovog rada (detaljnije opisano u samom radu) fokusirati na slijetanje na brodsku platformu na slijetanje dok brod neće biti u pokretu.

Faza slijetanja može se podijeliti u 3 kraće faze; navigacijska faza, manevar spuštanja i finalno, manevar slijetanja na palubu. U navigacijskoj fazi pilot ima zadatak da locira brodsku platformu za slijetanje i dovede helikopter u poziciju nedaleko od broda i pripremi se za manevar spuštanja pozicionirajući se direktno iza broda, budući da se platforma za slijetanje nalazi na stražnjoj strani broda. Jednom kad je helikopter u toj poziciji, započinje faza spuštanja u kojoj je cilj pravocrtni pristup brodskoj platformi za slijetanje. Sam pristup brodskoj platformi može se izvesti na nekoliko načina, a najjednostavniji način je *straight-in* pristup u kojem se helikopter spušta direktno prema platformi bez skretanja i takav će se pristup koristiti i u eksperimentu detaljnije pojašnjenom kasnije u tekstu. Slijetanje završava smirivanjem helikoptera iznad brodske platforme, lebdenjem u svrhu boljeg pozicioniranja i spuštanjem dok se ne ostvari kontakt sa platformom.

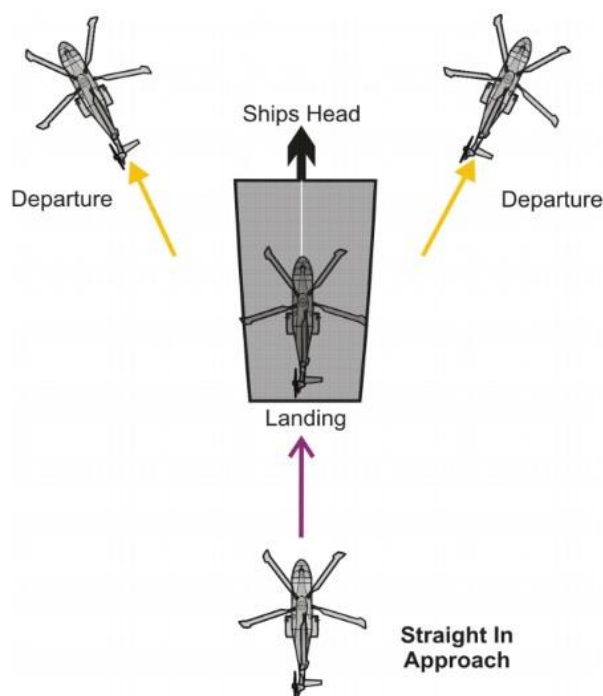

**Slika 4** Shematski prikaz za "straight-in" pristup helikoptera brodskoj platformi za slijetanje

Kako bi se donekle simulirao takav scenarij, osmišljeno je nekoliko misija na temelju kojih će se vršiti analiza radnog opterećenja asistiranog leta helikoptera koristeći neprofesionalne pilote volontere. Za potrebe ispitivanja, također je predviđeno i da se volonteri u ovoj analizi koriste sa dva načina prikazivanja podataka sa parametrima leta. Jedan od načina je na već ranije spomenutom ekranu instrumenta za prikazivanje umjetnog horizontal i stava letjelice, dok je drugi način prikazivanja na ekranu Head-Mounted Display-a. Misije su kronološkim redom prikazane na sljedećoj slici, a ukupno je 10 volontera prisustvovalo eksperimentu.

- 1. Task element: Visual reference flight**
  - 1.1. Task element: Visual reference flight without using PFD or HMD
  - 1.2. Task element: Visual reference flight using the PFD only
  - 1.3. Task element: Visual reference flight using the HMD
- 2. Task element: PFD Commanded values (Navigation phase)**
  - 2.1. Task element: PFD Commanded values: *ROLL*
- 3. Task element: HMD Commanded values**
  - 3.1. Task Element: HMD Commanded values: *ROLL*
    - I) *Debriefing: Simulator Sickness Questionnaire*
    - II) *Debriefing: Pilot Workload Questionnaire (Task Element: Visual reference flight, Task Element: PFD Commanded values, Task Element: HMD commanded values)*
    - III) *Debriefing: Pilot Biography Questionnaire*
- 4. Task Element: Descent and Landing**
  - 4.1. Task Element: Landing on the ADS-33 training platform (*Straight-in approach*)
  - 4.2. Task Element: Landing on the ship-deck without motion (*Straight-in approach*)
    - IV) *Debriefing: Pilot Workload Questionnaire (Task element: Landing)*

### **Slika 5      Prikaz procedure izvođenja eksperimenata za procjenu radnog opterećenja tokom leta**

Prve tri osmišljene misije predviđene su za upoznavanje i prilagođavanje na simulator i korištenje različitih izvora prikazivanja parametara leta, gdje su piloti u sve tri misije morali zadržati početni smjer leta te održati brzinu leta i visinu konstantnima. U prvoj misiji piloti su za referenciranje smjeli koristiti samo okolinu, bez korištenja instrumenata, dok su u drugoj i trećoj misiji koristili samo PFD ili HMD.

Sljedeće dvije misije zamišljene su na način da simuliraju navigacijsku fazu u kojoj su piloti morali pratiti zadani kut valjanja prikazan na instrumentima upravljajući lateralnim pomakom

cikličke pilotske palice sve dok letjelica ne dostigne prije misije određenu lokaciju. Koristeći već u simulator implementirani sustav automatskog navođenja helikoptera do određene točke, piloti-volonteri su na taj način koristili sustav autopilota sa određenom slobodom upravljanja. U jednoj misiji piloti su smjeli koristi samo PFD, dok su u drugoj, identičnoj misiji po karakteru, smjeli koristi samo informacije prikazane na HMD-u. Svrha ove misije bila je ispitivanje sposobnosti ne-profesionalnih pilota helikoptera da prate određeni signal i na taj način manevriraju helikopterom od jedne do druge lokacije. Budući da su se sve misije snimale za svakog volontera, a snimke su se spremale u MATLAB datoteke, rezultati ovih istraživanja koristiti će se za buduće analize u HELIOP projektu, kao i za buduća istraživanja urbane zračne mobilnosti.

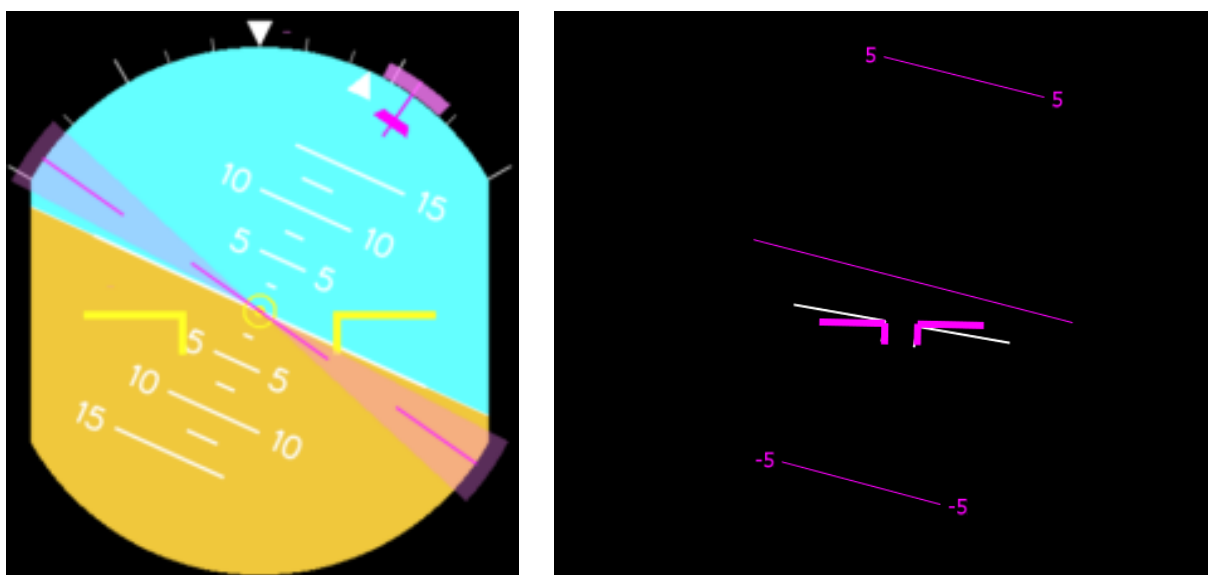

**Slika 6** Primary flight display sa umjetnim horizontom (lijevno), HMD ekran (desno)

U posljednjoj misiji eksperimenta od volontera se zahtjevalo da, bez ikakve asistencije u smislu praćenja određenog signala kao u prethodne dvije misije, izvedu dva slijetanja. Prvo slijetanje piloti su izvodili na platformu za treniranje manevra lebdenja i slijetanja ADS-33, smještena također u jezeru Tegernsee uz još nekoliko poligona za vježbu određenih manevara u letu helikoptera, dok je drugo slijetanje izvođeno na brodsku platformu 3D modela ranije opisanog broda tipa DDG-51 kako bi se kasnije mogla provesti subjektivna i objektivna analiza provedene misije. Prilikom slijetanja nije se koristio HMD, već samo PFD i vizualno referenciranje na temelju okoline.

Za potrebe analize subjektivne procjene radnog opterećenja pilota u navigacijskoj fazi i manevru slijetanja osmišljeno je nekoliko upitnika po uzoru na često korištenu Bedford-ovu skalu subjektivne procjene radnog opterećenja, sa prilagođenom skalom ocjenjivanja određenih parametara po uzoru na Likertovu skalu. Također, kako bi se dobio uvid u utjecaj načina prikazivanja parametara leta korištenim instrumentima na procjenu radnog opterećenja, izrađen je još jedan upitnik sa specifičnim pitanjima za taj utjecaj. Rezultati ovog upitnika biti će od koristi u budućnosti HELIOP projekta za unaprijeđivanje simbologije i načina prikazivanja parametara leta na instrumentima.

Budući da je poznata činjenica kako simulatori općenito izazivaju nepoželjne psihološke i fizičke utjecaje na ljude u smislu zamora, povraćanja, glavobolje i mnogih drugih čiji se intenzitet pojačava sa vremenom provedenim u simulatoru, predviđeno je kako bi ti efekti mogli imati utjecaja na subjektivnu procjenu radnog opterećenja. Kako bi se ispitali mogući utjecaji, korišten je i već poznati upitnik za procjenu istih na volontere [21].



**Slika 7** Provođenje eksperimenta sa “pilotom u petlji” za zadatak praćenja zadanog kuta valjanja

Nakon što su svi testovi završeni, a piloti ispunili sve upitnike, izvršena je analiza prikupljenih podataka. Graf na Slici 8 prikazuje srednje vrijednosti sa pridodanom analizom standardne devijacije od srednje vrijednosti, iz koje se može zaključiti kako su piloti generalno ocijenili kako je radno opterećenje prilikom izvođenja misija praćenja signala za kut valjanja manje u misijama u kojima se koristio HMD. Ista analiza napravljena je za misiju samog manevra slijetanja, te su rezultati prikazani na Slici 9, iz koje se vidi kako su piloti procijenili da je radno opterećenje bilo više u slučaju slijetanja na statičnu brodsku platformu.

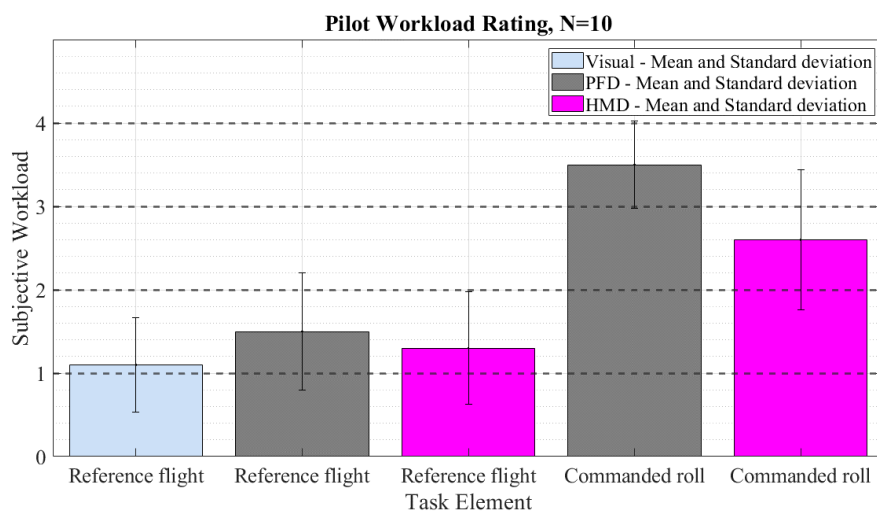

**Slika 8**      **Rezultati subjektivne procjene radnog opterećenja za prvih 5 misija eksperimenta**

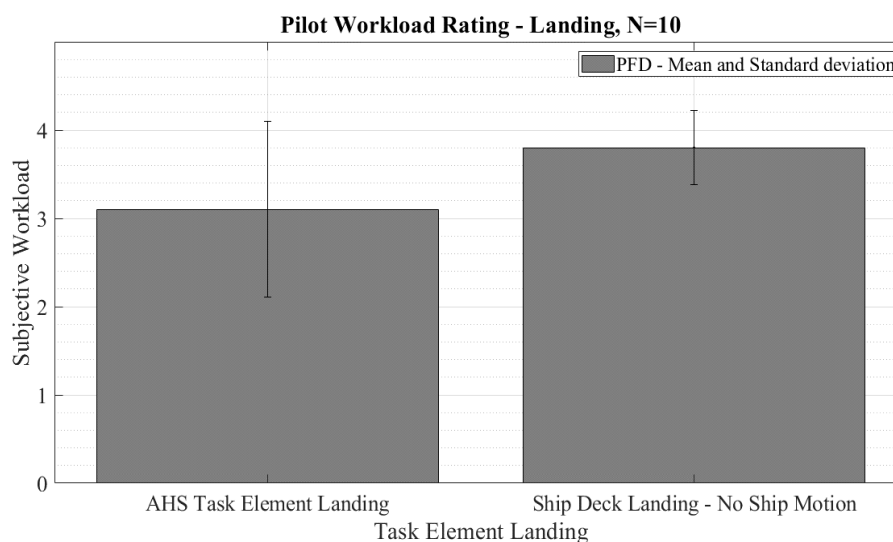

**Slika 9**      **Rezultati subjektivne procjene radnog opterećenja za misiju slijetanja**

Piloti su također imali priliku dati svoje mišljenje o preferiranom načinu prikazivanja parametara leta i signala kojeg su morali slijediti tokom misija vezanih za navigacijsku fazu, a na Slici 10 vidi se kako je HMD odabran kao preferirani način prikazivanja informacija u 100% slučajeva pred PFD-om.

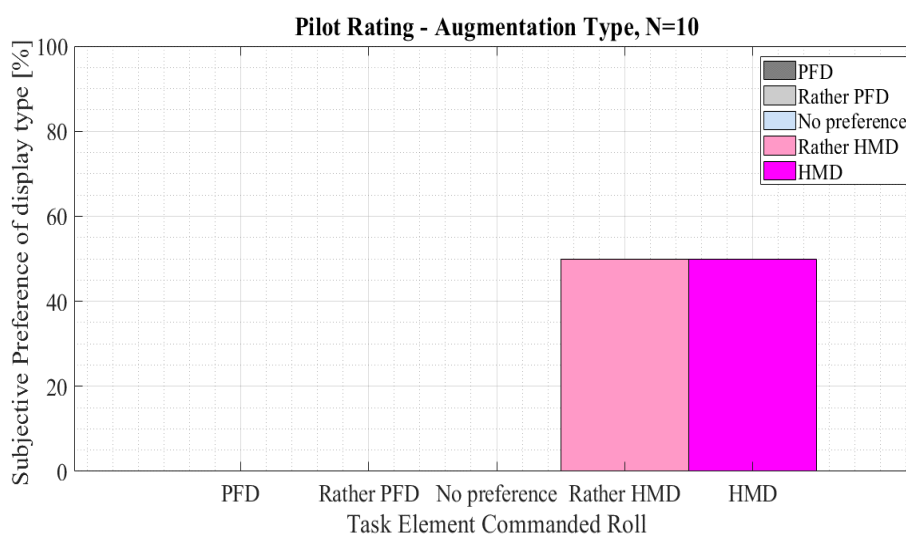

**Slika 10**      **Rezultati upitnika za preferirani način prikazivanja podataka - PFD vs. HMD**

Činjenica da je HMD odabran kao preferirani način prikazivanja parametara leta na određeni način se ne slaže sa analizom kvalitete praćenja signala u navigacijskim misijama budući da je nakon objektivne analize rezultata utvrđeno kako su volonteri generalno pratili signal sa manjom greškom u slučaju kada su signali bili prikazani na PFD-u, nego u slučaju kada su signali bili prikazani na HMD-u. Na Slici 11 prikazan je slučaj snimljenih signala za jednog od volontera, dok je na Slici 12 prikazana analiza varijance kao objektivno mjerilo kvalitete praćenja zadanog signala za svih deset volontera koji su sudjelovali u eksperimentima.

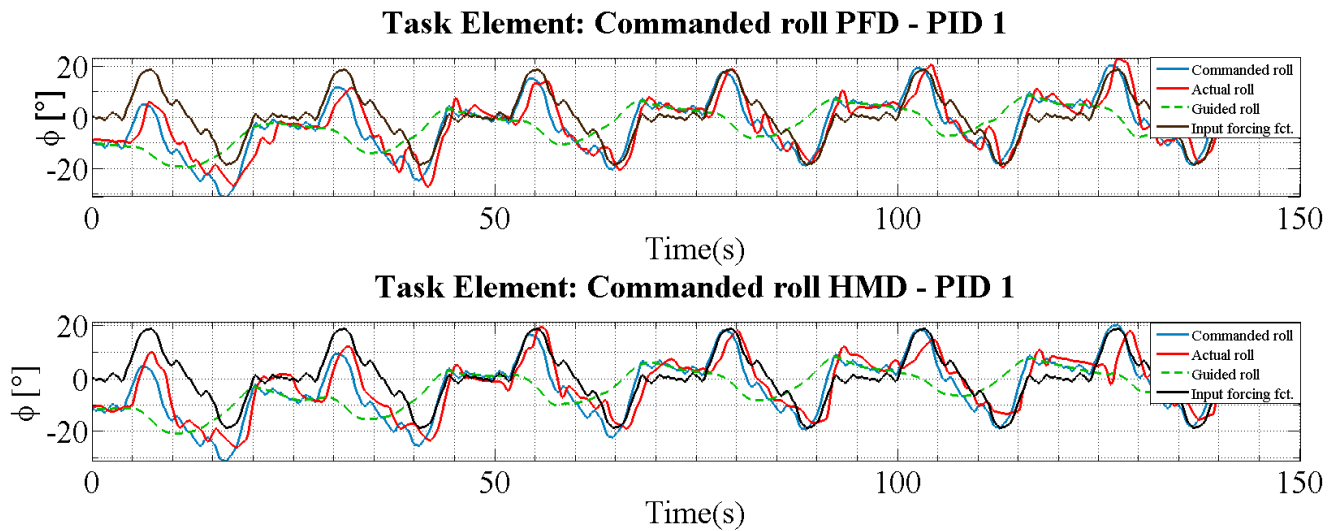

**Slika 11** Primjer snimke misije praćenja signala, korištene za objektivnu analizu

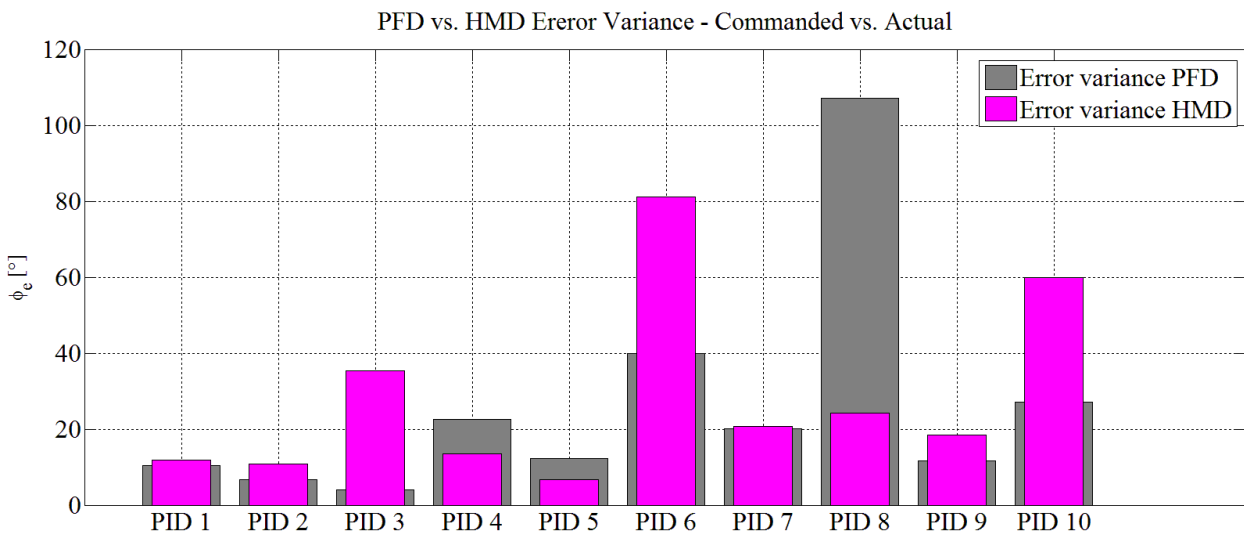

**Slika 12** Analiza varijance greške između stvarnog kuta valjanja i signala kuta valjanja za praćenje

Nadalje, za sam manevar slijetanja u posljednoj misiji, kako bi se pokušala povezati subjektivna procjena radnog opterećenja zabilježenog od pilota volontera sa aktivnosti pilotske cikličke



palice. Korištenjem snimljenih podataka i MATLAB softverskog paketa, napravljen je graf prikazan na Slici 13 koji prikazuje aktivnost pilotske palice u uzdužnom i poprečnom smjeru za oba slučaja slijetanja, na ADS-33 platformu za vježbanje i brodsku platformu za slijetanje na DDG-51 modelu broda po uzoru na [23]. Na grafu je vidljivo kako se prilikom slijetanja brodsku palubu intenzitet kretanja upravljačke palice značajno mijenja u odnosu na slijetanje na ADS-33 trening platformu u smislu da su pokreti mnogo manjeg raspona, ali puno više frekvencije promjene smjera, što može biti jedan od razloga procjene radnog opterećenja kao višeg u slučaju slijetanja na brod.

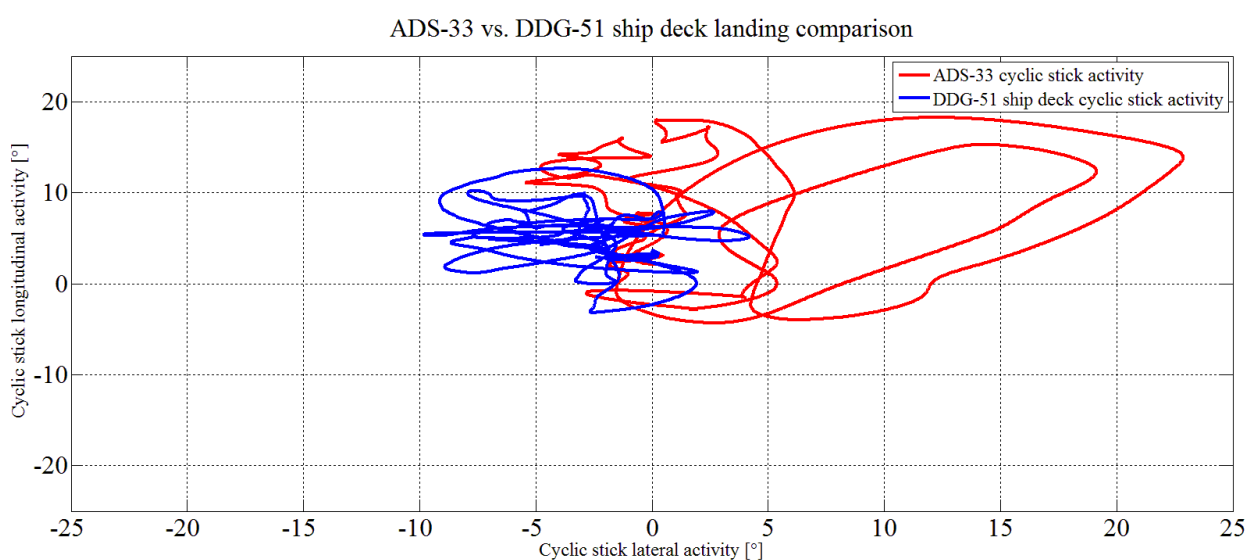

**Slika 13 Analiza aktivnosti pilotove upravljačke palice u manevru slijetanja za ADS-33 i brodsku platformu za slijetanje po uzoru na [23]**

Rezultati ovog diplomskog rada koristit će se u budućim eksperimentima HELIOP projekta, posebice za unaprijeđivanje načina prikazivanja parametara leta na određenim instrumentima, dok se također planiraju i sljedeći koraci u ispitivanju radnog opterećenja za slijetanje na brod u pokretu, čak i koristeći profesionalne pilote helikoptera sa iskustvom.

# 1 INTRODUCTION

## 1.1 Challenges of helicopter ship deck landing operations

All ship deck operations often provide a difficult operational environment for the fixed wing aircraft and for the rotorcraft (helicopters, drones, etc.) as well. Heavy wind over deck, degraded visual environment (DVE) and wake turbulence shed by ship super structure represent challenging and unpredictable conditions during take-off and landing which requires a very high level of helicopter operating skills by the pilot. Anything other than calm seas creates ship deck motion as pitch, roll, yaw, and heave. Due to that fact, different type of sea vessels behaves in a variety of ways due to their hull design, size, stabilization systems, etc. A major concern in this environment is the performance consistency during take-off and landing operations and the increased pilot workload. A helicopter pilot, while landing or taking off from such a platform must observe the heave, pitch, and roll motion of the landing platform and determine the landing contact time based on human reaction time as well as aircraft performance [1]. The time when helicopter ship deck operations were assumed to be „non-ordinary“ activity on the ships is far behind. In that time, those kinds of operations were not as common and recurrent as it is today. In these days, helicopter operations are commonly used on ships for crew changes, emergency medical lift offs, military operations, oil industry, wind energy industry and many more purposes [2]. This increase in frequency and use of the helicopters demands the need for the ship's crew as well as for the helicopter pilots to be completely familiarized with the precautions preparations and processes necessary in conducting helicopter ship deck operations.

To get better understanding about the procedure itself and the amount of workload a helicopter pilot including the ship deck crew must invest to ensure a swift and safe landing on a moving ship deck, a few important parts of the procedure will be described. A fair-weather condition plays a very important role in helicopter ship deck operations, they must be checked properly. The helicopter crew has to pay attention about the forecasted and expected weather conditions prior to the operation which includes checking the wind direction and speed, sky condition in terms of visibility, precipitation and sea state.

Rough sea and heavy currents are found adverse for helicopter ship deck landing and take-off operations which require counteracting actions and necessary allowance to be taken to maintain a given steady course. Furthermore, the helicopter crew has to maintain efficient communication with the ship's officer well in advance before the operations. During such communications, the officer on-board has to provide the helicopter crew with the information about the intended position of the helicopter operation, the course to be steered and the speed to be maintained by the ship during the operation, Estimated Time of Arrival (ETA) to the position and desired landing or winching area, but nevertheless, the crew has to keep constant watch on ship's course and speed.



**Figure 1 Helicopter approaching to the ship deck [3]**

Prior to that, the deck crew must prepare landing or winching area with utmost care and be ready with inventory of items used for helicopter operations. Such inventory often includes a crow bar, wire cutters, hand signals, emergency signal torch, marshalling batons, first aid equipment etc. All the loose objects in or near the area of operation should be removed and all aerials, running gears, equipment and objects in the area should be secured. Fire fighting pumps should be running, charged and be prepared to use in no time, including the portable fire

extinguishers and foam extinguishers. A rescue party must be ready for immediate rescue operations and firefighting which includes at least two crew members wearing full fire rescue uniform. The rescue boat must be prepared for immediate launching in case of man-overboard situation.

When everything listed above is prepared, it is time for a helicopter crew to successfully complete the landing procedure. That is the most demanding task of all since it requires the pilot crew to track and compensate all the ship deck motion like pitch, roll, yaw, heave, sway and surge and to adjust the helicopter commands with respect to latter to ensure swift landing. While tracking the ship motion, the helicopter is usually in a very low hover above the landing deck. When a helicopter is in a low hover over the ship, it is more vulnerable to many dangerous factors, many of which are mentioned previously, so the least amount of time spent in a hover to accomplish the mission safely greatly increases the odds of the mission being completed successfully, with no injuries or damage sustained on behalf of the ship or helicopter itself. [3]



**Figure 2** AH-64E helicopter landing on the USS Peleliu aircraft carrier [4]

## 1.2 Civil and military maritime helicopter operations

For hundreds of years, but more recently with the development of the global economy, the sea has been a major strategic channel for the transport of raw materials, goods and the exploitation of energy resources. The defense of maritime interests has, therefore, become a priority for many nations.

In this context, helicopters have proven to be one of the most effective assets to provide maritime security, thanks to their flexibility and ability to respond to the requirements of the various theatres of operation. Helicopters for naval applications frequently operate in particularly difficult and challenging environments; hence the need to design and build them as flexible multi-role platforms capable of performing a wide range of missions. They must be able to operate day and night in all weather conditions. Naval helicopter mission areas include Anti-Submarine Warfare (ASW) and Surface Warfare (SUW), Airborne Mine Countermeasures, Naval Surface Fire Support (NSFS), Naval Special Warfare (NSW), Vertical Replenishment (VERTREP), Mobility (MOB), Search and Rescue (SAR), Medical Evacuation (MEDEVAC), and VHF/UHF/Link Communication Relay (COMREL) and many more. Some of them will be described shortly just to show how important it is to ensure a successful helicopter ship deck landing [5].

- An ASW helicopter usually cooperates with a surface ship to follow or find an underwater target such as a submarine or a similar vessel.
- When used in a Surface Warfare (SUW) mission, the aircraft provides a mobile, elevated platform for observing, identifying, and localizing threat platforms beyond the parent ship's radar and/or electronic support measure (ESM) horizon. When a suspected threat is detected, classification and targeting data is provided to the parent ship via the datalink for surface-to-surface weapon engagement.
- In an Antiship Surveillance and Targeting (ASST) mission, the helicopter provides remote radar and sensors that can be controlled by the ship deck crew.
- In Naval Surface Fire Support (NSFS), the helicopter provides an excellent support for gunfire spotting. The helicopter can maintain a relatively stationary position from which the pilot and spotter can observe the area between salvo signal and fall of shot and provide the gunners with the information.

- Naval Special Warfare Forces (NSW) strike and rescue teams use sea-air-land (SEAL) crews, various air assets, fast attack-vehicles, and specialized surface craft. Squadrons equipped with helicopters are trained to conduct day and night CSAR and naval special warfare (NSW) operations in a hostile environment against small arms and infrared (IR) missiles.
- The helicopters are also used to help with the minesweeping operations in some specific cases. They can be employed to prevent sweepers from being mined, provide visual intelligence, verify sonar contacts, and locate and mark mines.
- In the Communications Relay (COMREL) mission, the aircraft serves as a receiver and transmitter relay station for over-the-horizon (OTH) communications between units.
- In the SAR mission, the aircraft is designed to search for and locate a target/object/ship or plane and to rescue personnel using the rescue hoist. Light Airborne Multipurpose System (LAMPS) crews are trained for both maritime and overland search and rescue missions.
- In the Medical Evacuation (MEDEVAC) mission, the aircraft provides for the medical evacuation of ambulatory and litter bound patients.
- Mobility (MOB) operations are the transfer of personnel. If landing is not practicable, the transfer will be made by hoist.



**Figure 3** Search and rescue helicopter on a demanding evacuation mission [3]

### 1.3 Connection to the TUM HELIOP project and approach to the problem

The work that will be presented in this Master's thesis will be a part of the Technical University of Munich (TUM) Helicopter Ship Deck Operations (HELIOP) project. The HELIOP project investigates the influence of the landing zone on pilot performance, limited field of view during landing procedure, take-off and landing in DVE and deals with many more helicopter ship deck operations challenges. For that purpose, the Head-Mounted Display (HMD) is used with predictive augmentation modes, displaying necessary information to the pilot – for instance parameters of the flight path – which enables enhancement of assistance systems. The predictive augmentation model of the HMI is harmonized with the flight loop designed in the MATLAB Simulink model, which will be described in the further text, so the Pilot-in-the-loop simulations can be performed [6]. The simulations mentioned above are performed with the Rotorcraft Simulation Environment (ROSIE) to evaluate display concepts and control mechanism under different environmental conditions.

ROSIE is a pilot-in-the-loop flight simulator with fixed base and a high-fidelity visual system.

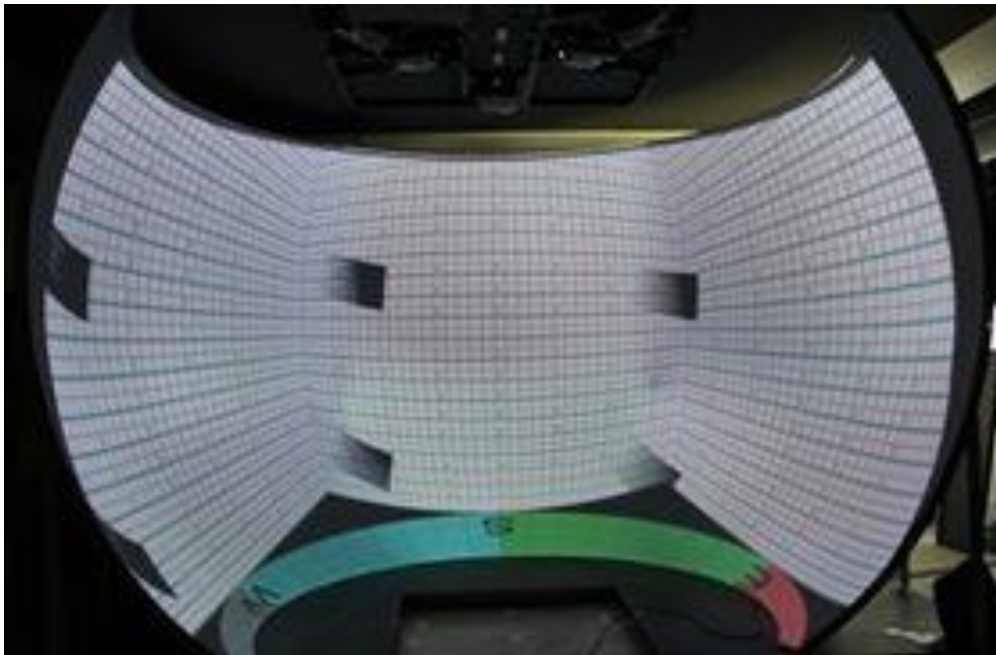

**Figure 4** Exterior view on a flight simulator connected to ROSIE at Technical University of Munich [6]

It utilizes GENSIM which is a non-linear flight model with the blade aerodynamic model based

on blade element/momentum theory with simple analytical downwash models and rigid blades. Flight model is defined for the EC-135, a twin-turbine light weight utility helicopter, a successor of BO-105. The research environment enables modifications in the simulation and access to the output data. [6]

ROSIE projection system offers a large field of view of  $200^\circ$  horizontal range and  $+30^\circ/-50^\circ$  vertical range on a spherical screen with a 5-meter diameter. The image on the screen is generated by 6 projectors, each with a WUXGA – resolution (1920 x 1200 pixels). To perfectly match generated imagery, a camera-based auto-calibration system is installed which also enables image warping and blending which can be realized using the image generator software.



**Figure 5** ROSIE projection plane [6]

The ROSIE architecture includes the „Sim-Host“ and the „Instructor Station“ which are the main elements of the simulator as they simulate the flight physics of the helicopter and take over the data management and the time scheduling of the simulator via the Simulink flight loop. Additionally, three human machine interface computers are installed within the cockpit and another six computers (one for every image projector) are used for image generation of the external imagery.



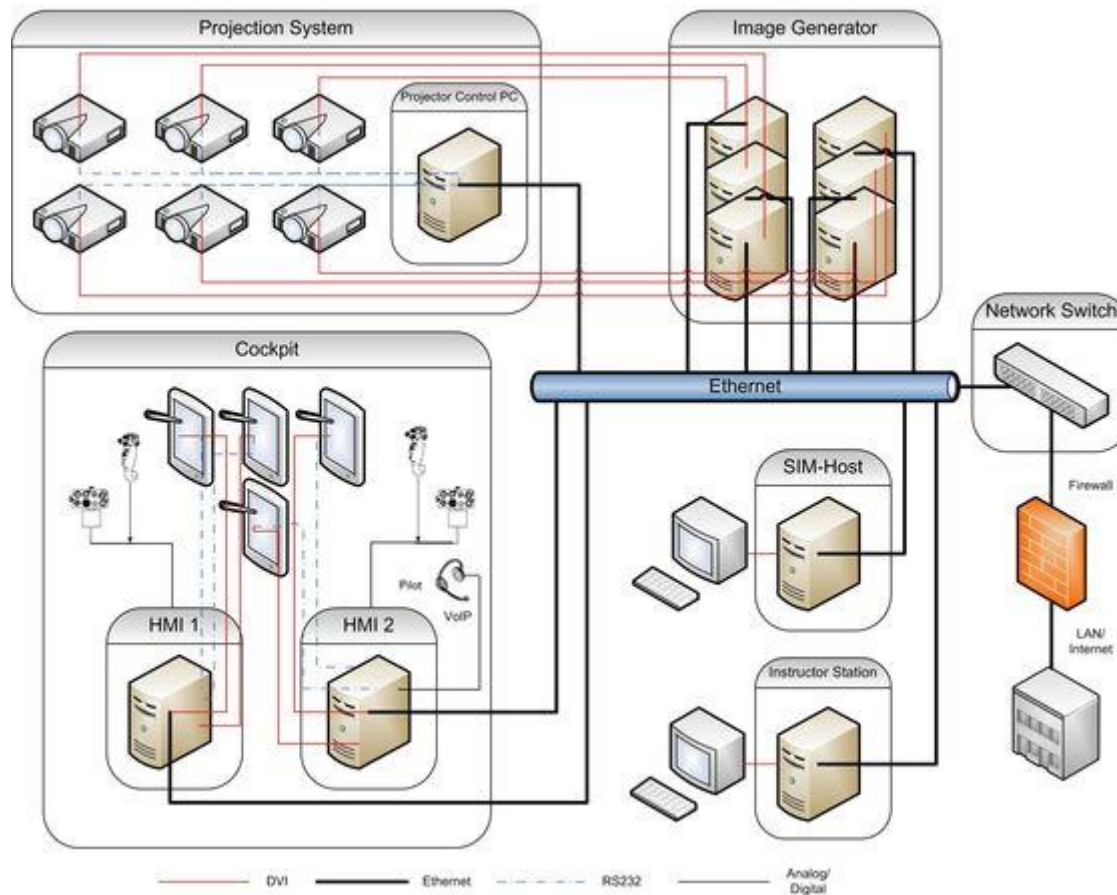

**Figure 6** ROSIE architecture design [6]

ROSIE also has a realistic original Bo105 type helicopter cockpit in which pilot and co-pilot can be situated and fly realistic simulation scenario together which is enabled by dual-controls with artificial-force-feeling and the trim command. Most of the instruments are replaced by the touch panels so previous and future cockpit head down instruments can be simulated easily by downloading the instruments design and uploading it to ROSIE.



**Figure 7** The original Bo105 cockpit for the pilots [6]

The simulation environment also includes a digital terrain elevation model of whole Germany area with a resolution of up to 1 m and very high-resolution aerial imagery of up to 0.2 m/px. For the purposes of the simulated scenario in this master's thesis, Tegernsee lake was chosen to conduct the helicopter ship deck landing. [6]

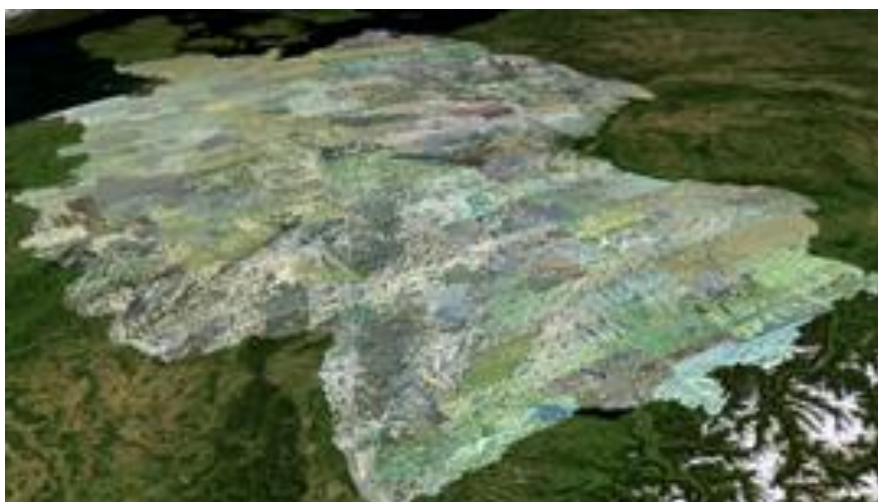

**Figure 8** Digital terrain model used as simulation environment [6]

## 2 SYSTEMATIC CHARACTERIZATION OF NAVAL ENVIRONMENT DATABASE

### 2.1 Specification and implementation of the SCONE database

To introduce the data of the ship deck motion that will be used to conduct flight tests in the future work on the HELIOP project, a Systematic Characterization of the Naval Environment (SCONE) [7] database recorded data for the ship motion will be used. The data is provided for a generic surface combatant ship (DTMB Model 5415 hull, which is a representative of a DDG-51 type ship). The DDG-51 type ship is a destroyer class naval vehicle used by the US Marine Forces [9]. It is not unusual for this class of ship to cooperate with helicopters in helicopter ship deck landing operations like SAR or submarine warfare. A DDG-51 type ship model will be used in the flight test simulations which will be described later in the section 4. The SCONE database itself has already been used in academic research purposes like autonomous ship approach and landing with deck motion prediction [10] and [11].



**Figure 9** The USS Arley Burke class destroyer (DDG-51 type) with a helicopter landing spot [12]

The main dimensions of the ship, including the hull characteristics can be found in the following table, which was made with respect to [7].

**Table 1 Principal dimensions and hull characteristics of the SCONE ship model**

Dimension	Symbol	Value
Length, overall	$L_{OA}$	497.4 [ft]
Length, waterline	$L_{WL}$	464.1 [ft]
Beam, maximum	B	69.6 [ft]
Beam, waterline	$B_{WL}$	62.6 [ft]
Draft, baseline	T	21.4 [ft]
Draft, maximum	$T_{max}$	31.5 [ft]
Displaced Volume	V	$3.23 \times 10^5$ [ft <sup>3</sup> ]
Longitudinal center of gravity	LCG	236.5 [ft] from FP
Vertical center of gravity	VCG	4.43 [ft] above WL
Metacentric height (transverse)	$GM_T$	5.37 [ft]

The hull geometry, at its static flotation, is shown in the figure below:

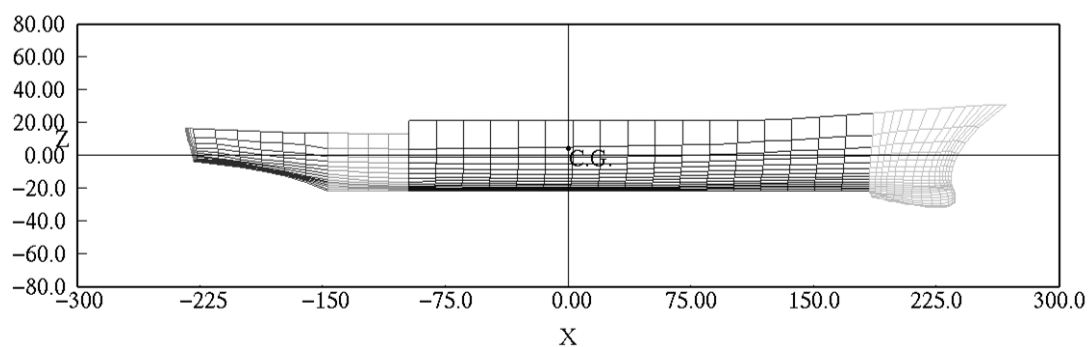

**Figure 10 2D SCONE ship model hull geometry with the reference point ("Center of Gravity") [7]**

The data provided in the SCONE database [7] was obtained using a state-of-the-art non-linear seakeeping prediction code (LAMP) and it corresponds to motion at the flight deck of a generic DDG-51 class destroyer ship in various sea conditions. The helicopter landing spot is located 130 [m] longitudinally aft of the ship forward perpendicular (FP), on the ship lateral centerline, and 16.4 ft above the waterline. Every file within the SCONE database contains a set of data which describe different ship deck motion with respect to roll intensity and heave rate intensity of the ship. The roll intensity and heave rate intensity of the ship are described as „low“, „moderate“ and „high“ conditions. For each condition, five simulations (referred to as ‘realizations’) were executed with differing, random wave phases. Thus, there are five 30-minute time histories for each deck motion condition.

In conclusion, every file contains 5 subsets of the following data with the 20 Hz sampling rate:

**Table 2 SCONE data description**

X coordinate [ft]	Roll angle [°]	Roll rate [°/s]	Roll acceleration [°/s <sup>2</sup> ]	Surge [ft/s]	Surge rate [ft/s <sup>2</sup> ]
Y coordinate [ft]	Pitch angle [°]	Pitch rate [°/s]	Pitch acceleration [°/s <sup>2</sup> ]	Sway [ft/s]	Sway rate [ft/s <sup>2</sup> ]
Z coordinate [ft]	Yaw angle [°]	Yaw rate [°/s]	Yaw acceleration [°/s <sup>2</sup> ]	Heave [ft/s]	Heave rate [ft/s <sup>2</sup> ]

The LAMP predictions are time-domain simulations which incorporate a nonlinear calculation of the incident wave forcing and hydrostatic restoring, a body-linear 3-D potential flow solution of the wave-body hydrodynamic interaction forces (radiation, diffraction and forward speed) and semi-empirical models for viscous roll damping and drag, appendage (rudder and bilge keel) lift and drag, propeller thrust and hull maneuvering forces. The propeller is operated at a constant rotation rate corresponding to a command calm water speed, so simulations included an unsteady variation in speed, though this variation is small for the selected conditions.

## 2.2 Description of coordinate systems used within the SCONE database

The ship motion is described by the position of a flight deck reference point and the orientation (roll, pitch and yaw angles) of the ship in a global (earth-fixed) coordinate system, and its 6-DOF velocity and acceleration vectors. The flight deck reference point is located at the center of the landing area on the stern of the ship. The global (earth-fixed) coordinate system is defined as follows:

- X-axis is positive in the mean direction of the ship travel with  $X=0$  being the approximate position of the deck at the start of the simulation. The X coordinate of the motion data will include the forward speed of the ship.
- Y-axis is positive to starboard with  $Y=0$  being the base (commanded) track of the ship.
- Z-axis is positive downward with  $Z=0$  being the level of the undisturbed sea surface. Since the deck reference point is above the mean waterline, this value will have a negative mean value.

The orientation of the ship is expressed as roll, pitch and yaw angles relative to the ship's initial (static) position. These orientation angles are shown in Figure 11.

### 2.3 SCONE Data Description

The files are formatted (ASCII) text files with 19 columns of data and a row for each time step.

The first 7 columns in the text files are defined as:

1. Time in seconds, 0.0 at start of recording period
2. X coordinate of the ship's flight deck reference point (ft)
3. Y coordinate of ship's flight deck reference point (ft)
4. Z coordinate of ship's flight deck reference point (ft)
5. Roll angle (deg) – Euler rotation about the X coordinate axis (a positive value is a roll to starboard)
6. Pitch angle (deg) – Euler rotation about Y coordinate axis (a positive value is bow-up)
7. Yaw angle (deg) – Euler rotation about Z coordinate axis (a positive value is the bow swung to starboard)

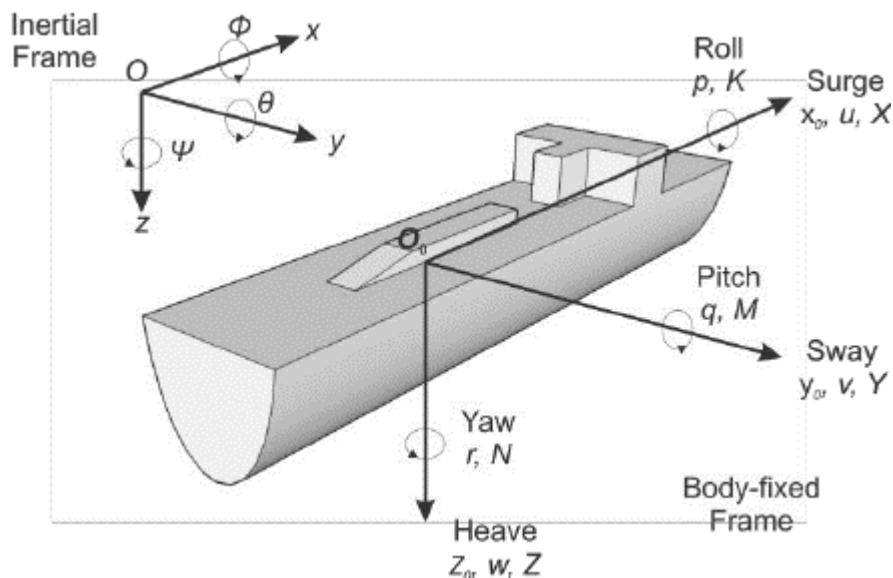

**Figure 11** Graphical representation of the ship's coordinate system [8]

Columns 8-10 are the surge, sway and heave velocities, output in ft/sec and expressed as the velocity of the deck reference point in the global (earth-fixed) coordinate system. Columns 11-13 are the roll, pitch and yaw rates, output in deg/sec and expressed as angular velocity about the deck reference point in a ship-fixed coordinate system. Columns 14-16 are the surge, sway and heave acceleration, output in ft/sec<sup>2</sup> and expressed as the acceleration of the deck reference point in the global (earth-fixed) coordinate system. Columns 17-19 are the roll, pitch and yaw acceleration, output in deg/sec<sup>2</sup> and expressed as the acceleration about the deck reference point in a ship-fixed coordinate system [7].

## 2.4 Definition of the rotation angles and rotation matrix

The angular motion (roll, pitch and heave) of the ship is defined as Euler rotation angles which can be considered as a set of successively applied rotation which transform a position vector of a point from the initial (static) coordinate system to position vector in the global coordinate system at a specific time. The equations below define this transformation numerically:

$$\mathbf{r}_{global} = \mathbf{R}\mathbf{d}_{global} + \bar{T}(\phi, \psi, \theta)(\mathbf{r}_{static} - \mathbf{R}\mathbf{d}_{static}) \quad (1)$$

$$\bar{T}(\phi, \psi, \theta) = \begin{bmatrix} \cos \psi \cos \theta & \sin \phi \sin \psi \cos \theta - \cos \phi \sin \theta & \cos \phi \sin \psi \cos \theta + \sin \phi \sin \theta \\ \cos \psi \sin \theta & \sin \phi \sin \psi \sin \theta + \cos \phi \cos \theta & \cos \phi \sin \psi \sin \theta - \sin \phi \cos \theta \\ -\sin \psi & \sin \phi \cos \psi & \cos \phi \cos \psi \end{bmatrix}$$

$\mathbf{r}_{global}$  = position vector of a point in global coordinates

$\mathbf{r}_{static}$  = position vector of a point in initial (static) coordinates

$\mathbf{R}\mathbf{d}_{global}$  = position vector of a deck reference point in global coordinates

$\mathbf{R}\mathbf{d}_{static}$  = position vector of a deck reference point in initial coordinates

$\phi$  = roll angle = Euler rotation about X-axis (data file column 5)

$\psi$  = pitch angle = Euler rotation about Y-axis (data file column 6)

$\theta$  = yaw angle = Euler rotation about Z-axis (data file column 7)



### 3 INTEGRATION OF SCONE DATABASE TO ROSIE

#### 3.1 Transferring the SCONE database in MATLAB

As it is already mentioned in the previous paragraph, the SCONE data for the DDG-51 type frigate ship is a set of ASCII formatted text files containing the recorded motion data with respect to time with 50 Hz frequency. Since ROSIE uses Simulink to run the flight loop, the data had to be prepared in MATLAB prior to the Simulink model implementation. All the „.dat“ SCONE files were transferred into the MATLAB workspace but since MATLAB cannot work with „.dat“ files, those files had to be loaded in matrices.

The screenshot shows the MATLAB 'Import' dialog box for a file named 'SCONE\_DIH1.dat'. The 'Import Selection' button is highlighted with a red arrow. Below the dialog, a portion of the imported data matrix is visible, showing columns for Time, X, Y, Z, Rot\_X, Rot\_Y, Rot\_Z, Vx, Vy, Vz, and V\_roll.

	A	B	C	D	E	F	G	H	I	J	K	
1	SCONE_DIH_1											
2	NSWCCD, Sea-Base Aviation and Aeromechanics Branch (Code 882)											
3	April 2015											
4	Time	X	Y	Z	Rot_X	Rot_Y	Rot_Z	Vx	Vy	Vz	V_roll	
5	-0.49999129E-01	-0.19026762E+03	0.93307072E+00	-0.18653988E+02	-0.17341275E+01	-0.31933498E+00	-0.20325262E-03	0.85051708E+01	-0.19405538E+00	-0.10289775E+01	-0.95287943E+00	-0.2
6	0.00000000	-0.18984242E+03	0.92387146E+00	-0.18702885E+02	-0.17806792E+01	-0.33293897E+00	-0.81490120E-03	0.85028629E+01	-0.17382328E+00	-0.92622834E+00	-0.90927118E+00	-0.2
7	0.49999129E-01	-0.18941733E+03	0.91571254E+00	-0.18746624E+02	-0.18250415E+01	-0.34555256E+00	-0.18364808E-02	0.85005255E+01	-0.15230171E+00	-0.82349879E+00	-0.86542910E+00	-0.2
8	0.99998154E-01	-0.18899239E+03	0.90864861E+00	-0.18785162E+02	-0.18672031E+01	-0.35715371E+00	-0.32739444E-02	0.84978008E+01	-0.13012934E+00	-0.71747011E+00	-0.82135409E+00	-0.2
9	0.14999738	-0.18856755E+03	0.90270895E+00	-0.18818373E+02	-0.19071567E+01	-0.36769617E+00	-0.51230486E-02	0.84949713E+01	-0.10741065E+00	-0.61090857E+00	-0.77727807E+00	-0.1
10	0.19999652	-0.18814288E+03	0.89792424E+00	-0.18846228E+02	-0.19449016E+01	-0.37715927E+00	-0.73804893E-02	0.84919405E+01	-0.83833896E-01	-0.50308561E+00	-0.73309219E+00	-0.1
11	0.25000262	-0.18771837E+03	0.89432818E+00	-0.18868668E+02	-0.19804366E+01	-0.38551560E+00	-0.10043536E-01	0.84887362E+01	-0.59972078E-01	-0.39437723E+00	-0.68904710E+00	-0.1
12	0.30000174	-0.18729402E+03	0.89193636E+00	-0.18885658E+02	-0.20137687E+01	-0.39274284E+00	-0.13103070E-01	0.84853945E+01	-0.35627823E-01	-0.28511858E+00	-0.64508307E+00	-0.1
13	0.35000089	-0.18686983E+03	0.89076972E+00	-0.18897173E+02	-0.20449040E+01	-0.39882237E+00	-0.16551301E-01	0.84819269E+01	-0.10984596E-01	-0.17550980E+00	-0.60132992E+00	-0.1
14	0.40000001	-0.18644582E+03	0.89083998E+00	-0.18903208E+02	-0.20738549E+01	-0.40373886E+00	-0.20376764E-01	0.84783545E+01	-0.13747838E-01	-0.65878391E-01	-0.55781865E+00	-0.8
15	0.44999912	-0.18602200E+03	0.89214808E+00	-0.18903763E+02	-0.21006346E+01	-0.40748030E+00	-0.24566030E-01	0.84746876E+01	0.35632192E-01	0.43676633E-01	-0.51462132E+00	-0.5
16	0.49999827	-0.18559837E+03	0.89470100E+00	-0.18998851E+02	-0.21252601E+01	-0.41003782E+00	-0.29104663E-01	0.84709806E+01	0.63477129E-01	0.15268840E+00	-0.47175291E+00	-0.3
17	0.54999745	-0.18517490E+03	0.89849609E+00	-0.18888502E+02	-0.21477480E+01	-0.41140783E+00	-0.33976655E-01	0.84672422E+01	0.88328585E-01	0.26100484E+00	-0.42921835E+00	-0.1
18	0.59999651	-0.18475165E+03	0.90352708E+00	-0.18872765E+02	-0.21681187E+01	-0.41158903E+00	-0.39164133E-01	0.84634733E+01	0.11282752E+00	0.36841708E+00	-0.38719058E+00	0.1
19	0.64999568	-0.18432855E+03	0.90978020E+00	-0.18851685E+02	-0.21863949E+01	-0.41058323E+00	-0.44645838E-01	0.84597492E+01	0.13728288E+00	0.47451791E+00	-0.34548971E+00	0.3
20	0.70000178	-0.18390569E+03	0.91724813E+00	-0.18825336E+02	-0.22025959E+01	-0.40839791E+00	-0.50402775E-01	0.84560423E+01	0.16135892E+00	0.57917809E+00	-0.30427864E+00	0.5
21	0.75000089	-0.18348296E+03	0.92591071E+00	-0.18793798E+02	-0.22167466E+01	-0.40504259E+00	-0.56411339E-01	0.84523935E+01	0.18507114E+00	0.68201298E+00	-0.26352343E+00	0.8
22	0.80000001	-0.18306042E+03	0.93574985E+00	-0.18757168E+02	-0.22286697E+01	-0.40055312E+00	-0.62648326E-01	0.84488925E+01	0.20845030E+00	0.78288925E+00	-0.22920846E+00	0.1

Figure 12 SCONE database files imported to Matlab software

By using this approach, the data was now generated into matrices where every column contained the numerical values of time, position coordinates, rotation angles etc., in order that was described in the previous section. Once the matrices were created, it was possible to manipulate the data using MATLAB software and implement it as Simulink blocks to finally connect it to the ROSIE flight loop.

The naming of the matrices is kept simple and intuitive to use with following guidelines. Every matrix name starts with „SCONED“ which represents SCONE database, followed with a short description of the scenario recorded within the matrix. For example, matrix which contains the recorded data about the scenario in which the ships rolling motion was dominating contains the abbreviation „1R“, „2R“ or „3R“ depending on the roll motion intensity. In this case „1R“ means that the recorded scenario contains the data set of 19 values (time, coordinates, angles etc.) for the „Level 1“ ship roll intensity. The „Level 1“, „Level 2“ an „Level 3“ can be interpreted as the „low“, „moderate“ and „high“ motion intensity respectively.

The difference between the levels motion intensity will be shown after describing the naming. It is also mentioned in the previous part that every motion intensity level scenario is recorded five times with random wave phases. Having that fact in mind, a number between one and five follows the motion intensity level description in the naming.

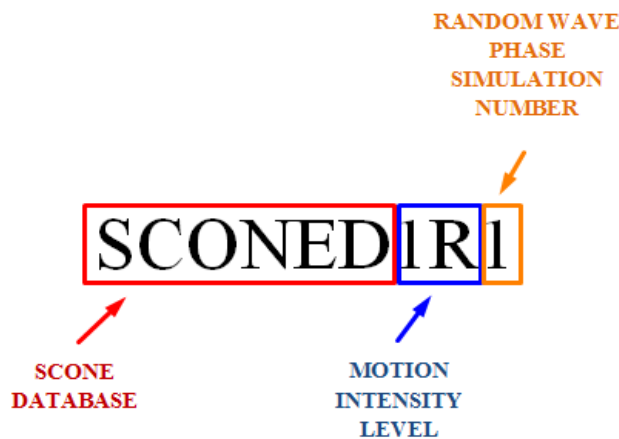

**Figure 13 Graphical explanation of the SCONE database file nomenclature**

For the purposes of clarifying the output data from the SCONE database, a following plot was drawn using the MATLAB software. Even though there is 30 minutes of the recorded data, a short time period of 170 seconds was used to compare three different roll intensity levels. From the following plot, it can be seen that „Level 1 roll intensity“ case has the minimum amplitude roll angle value with respect to the other two cases and „Level 3 roll intensity“ has the highest values of roll angle amplitude.

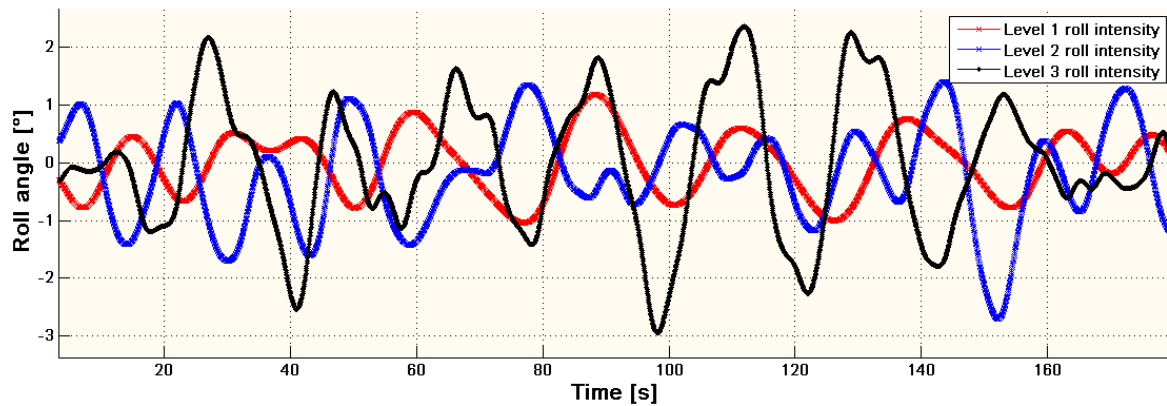

**Figure 14** Graphical comparison of different roll intensity levels found within the SCONE database

Following that example, one plot containing heave values for three heave intensity levels is made, to once more observe the difference in intensity between the levels.

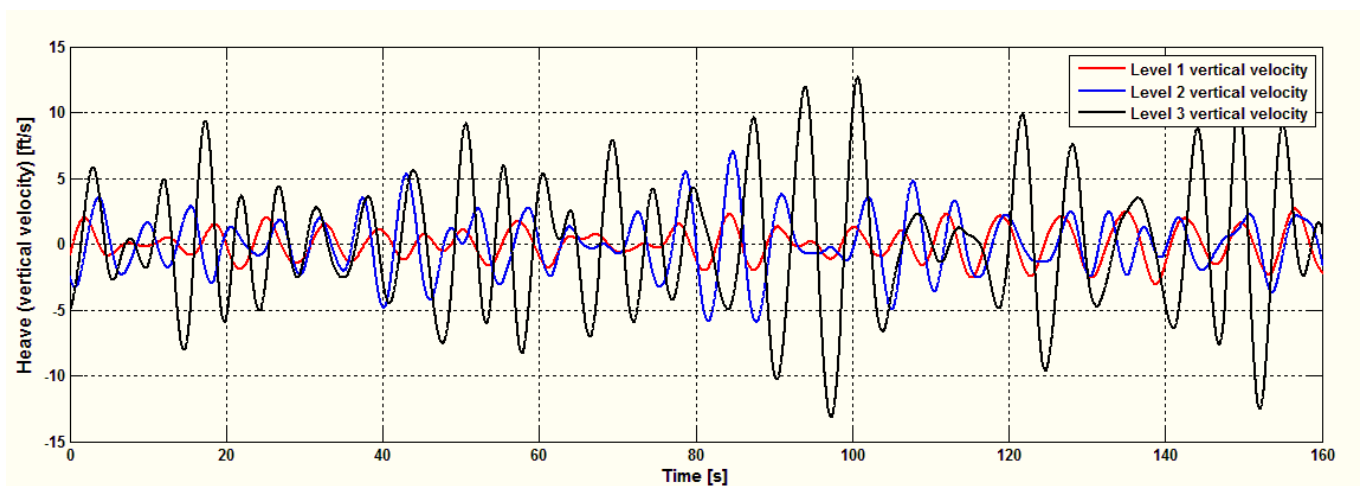

**Figure 15** Graphical comparison of different heave intensity levels found within the SCONE database

### 3.2 SCONE Simulink subsystem

Since the whole SCONE database is designed in Simulink which uses a block subsystem hierarchy model, a top-down approach will be used to describe the ship motion database designed for purposes of further analyses. The motivation for this kind of approach was driven by the intention that it enables the user to choose the specific motion data, whether it is necessary to choose only one signal (for example only the ship rolling motion data), or all 18 motion data signals [7], while interacting with the main data switch only.

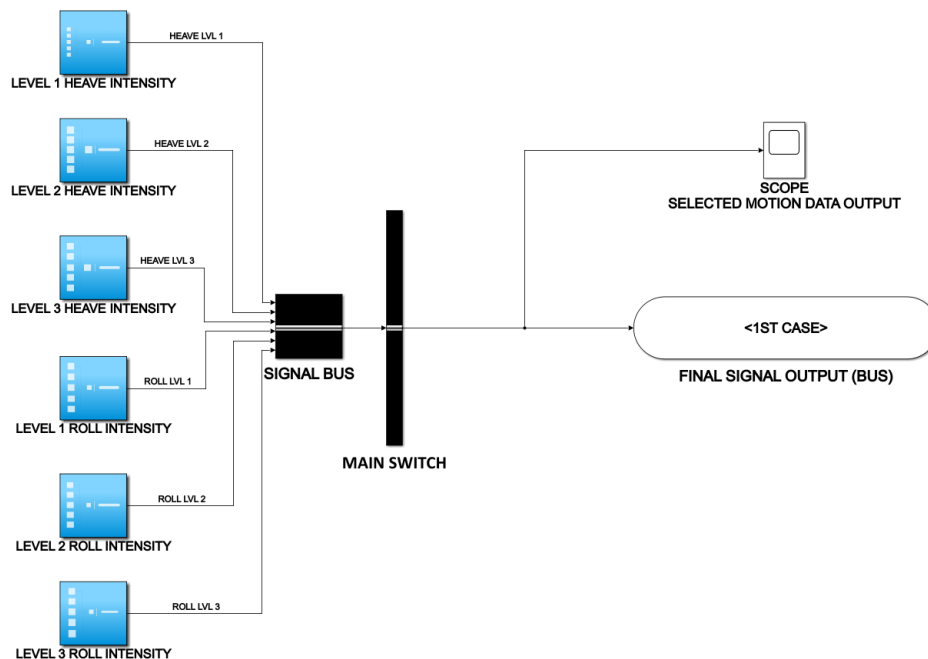

**Figure 16** Simulink model of the SCONE database - top level architecture view

As it was previously mentioned in the section 2.1 („Specification and implementation of the SCONE database), the whole database is founded and characterized upon two dominant ship motions respectively – ship rolling motion and ship heaving motion. If Figure 16 is closely observed from left to right, it can be noted that there are six blue blocks, each and every one of them representing one of mentioned cases. Levels one, two and three represent the intensity of the corresponding motion as „low“, „moderate“ and „high“.

Every block contains a full set of recorded ship motion data which were described more thoroughly in the section 2.1. All six blocks are connected to the signal bus to ensure that all the required data for the analysis is passing through to the main switch. The function of the main switch itself will be explained more thoroughly after the top-down hierarchy description, since it is meant to be the main interface a user should be operating with while using the SCONE database. To simplify the process of checking the data before sending it to ROSIE environment, Simulink „Scope“ block was implemented which draws a plot of all the data passing through the system.

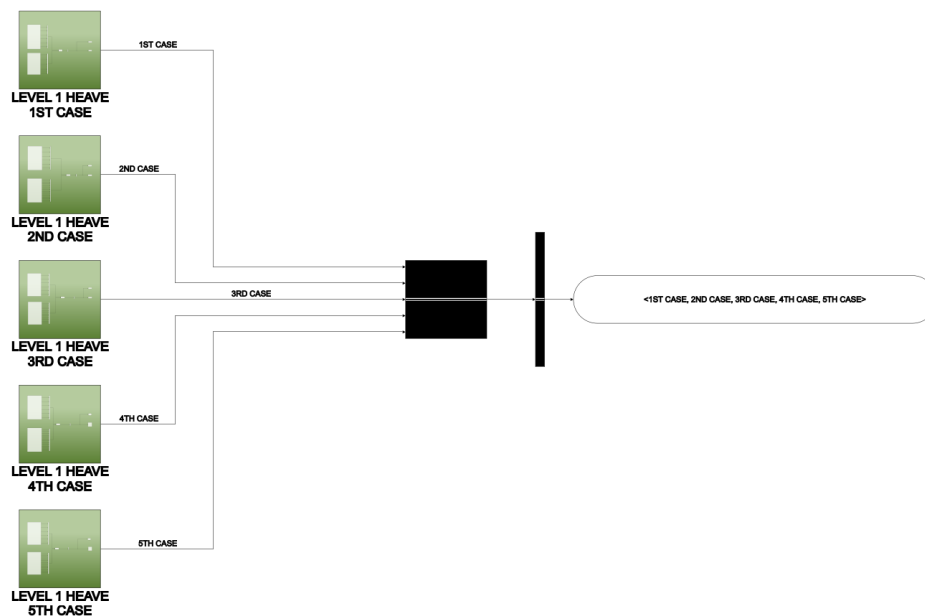

**Figure 17 Simulink model of the SCONE database architecture - implementation of the random wave phase cases**

Next hierarchical level can be found in Figure 17, as it contains the five blocks (marked in dark green color). Each of those blocks represents one of five previously mentioned random wave phase recorded data for each and every motion intensity level in the top-level hierarchy. It also contains a bus creator Simulink block which connects all the green blocks, to ensure that all the data is passing through this hierarchical level successfully to the upper level.

Each one of the green blocks can be furtherly decomposed into the following hierarchical level represented in the Figure 18.

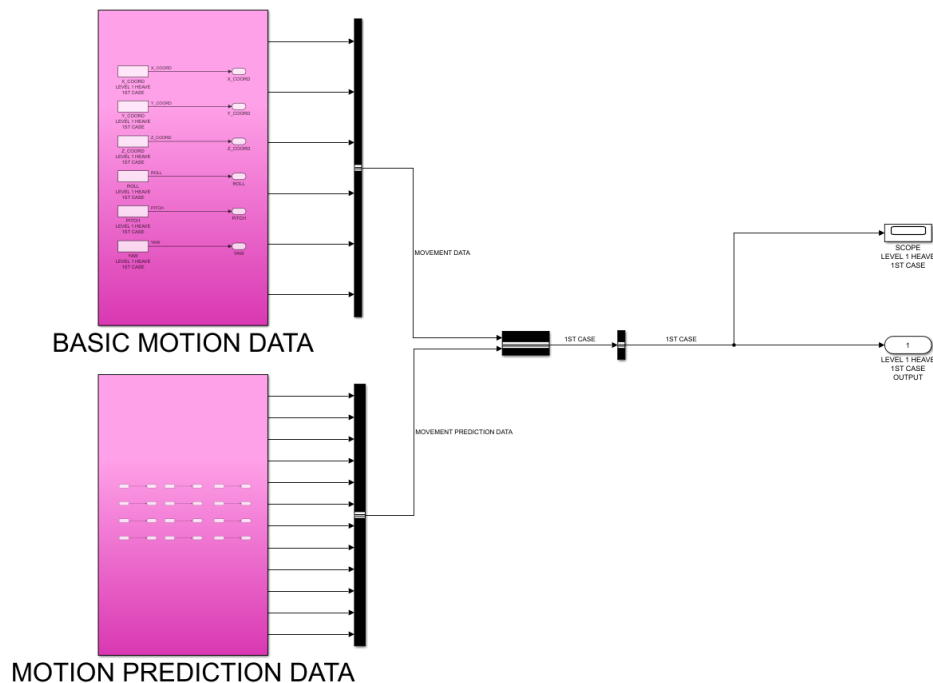

**Figure 18** Simulink model of the SCONE database - motion data and motion prediction data

The architecture of the following hierarchical level was designed by having in mind possible future investigations and analyses inside the HELIOP project. This level is divided into two subsystems colored in magenta in the figure, where the upper block named „BASIC MOTION DATA“ contains only the values that are necessary to provide for projecting the ship motion on the ROSIE projection plane. To be more specific, this block contains only the information about the translations ( $x, y, z$  coordinates) and rotations ( $\phi, \psi, \theta$ ) of the ship fixed coordinate system with origin positioned in the middle of the ship deck landing surface. The other block called „MOTION PREDICTION DATA“ contains the rest of the data – translational velocities and accelerations as well as angular velocities and accelerations. Since one of the topics of the HELIOP project deals with different controllers for autonomous helicopter flight, navigation and descent and landing on the ship [13], the data could be valuable for possible further investigation. Even though the data is divided into two subsystems, all the data is connected to the bus, just like in the previous hierarchical levels. The last system level contains the data

which is fed from the SCONE database predesigned previously in MATLAB workspace, which is described thoroughly in the 3.1 section. To ensure that the data can be read, before running the Simulink model, MATLAB workspace has to be preloaded, which is solved by implementing a line of code which preloads the data when the ROSIE flight loop is commanded to run.

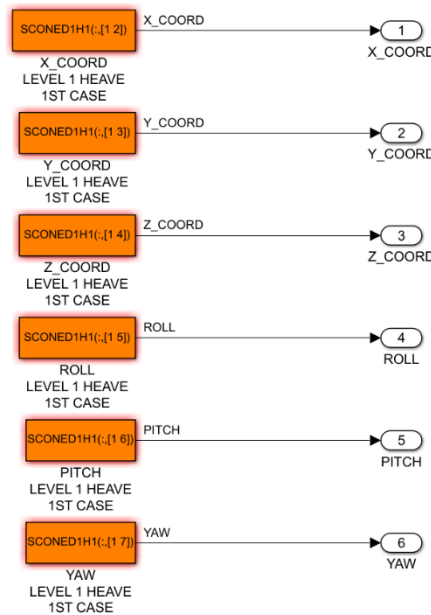

Figure 19 Decomposition of the "Basic Motion data" Simulink subsystem

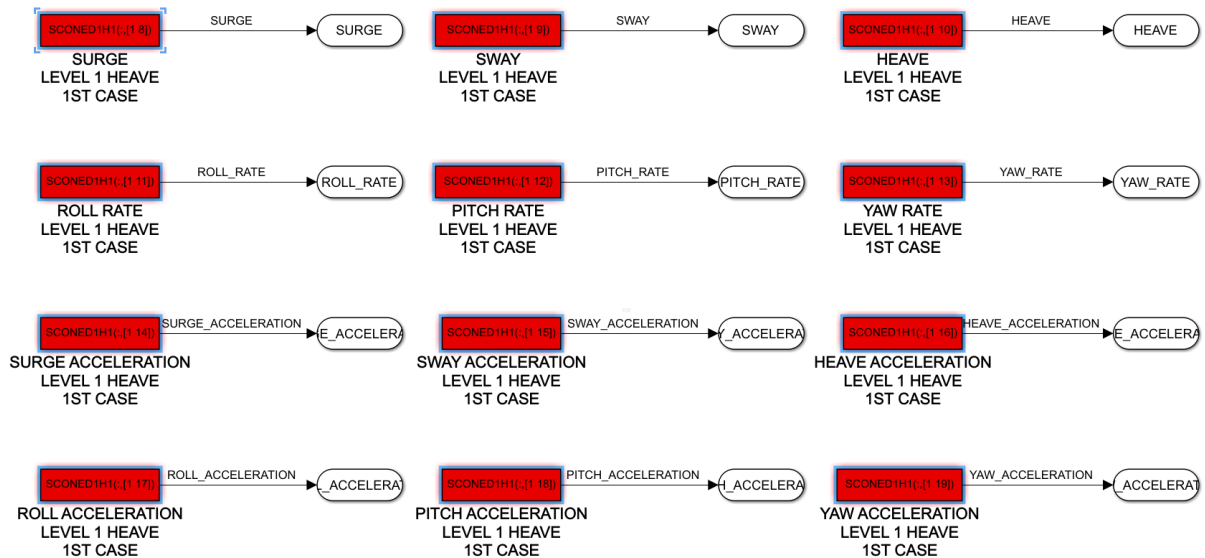
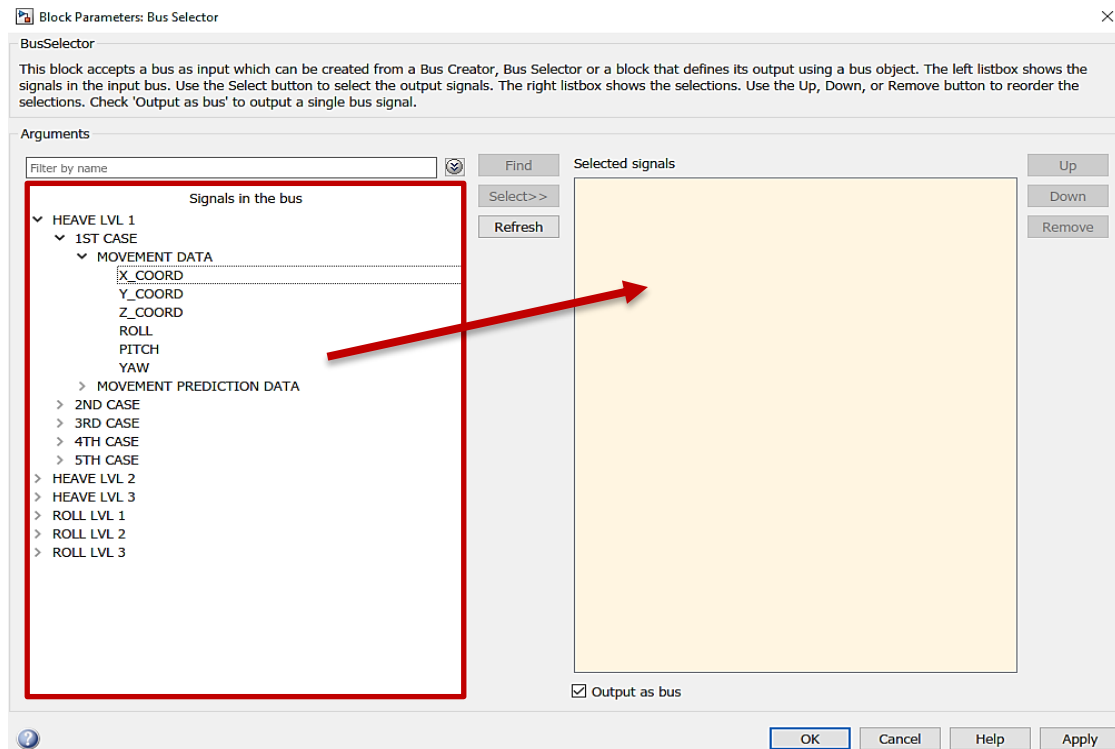

Figure 20 Decomposition of the "Motion prediction data" Simulink subsystem

Now, when the Simulink SCONE system hierarchy decomposition is described, the main switch can be described more thoroughly. By double clicking on the main switch Simulink icon, a very intuitive user interface appears.



**Figure 21** Simulink SCONE database signal selection user interface

In the red box left in the user interface display, all the data passing through the top system level signal bus can be seen in a drop-down menu, with a clear hierarchy. The user can easily pick the signal that he wants to feed ROSIE with (or a group of signals) and click on „Select“. Very important thing to note is that the „Output as bus“ option has to be enabled when selection more than only one signal. For instance, if the ROSIE ship model wants to be fed with the data for recorded low heave intensity first case (random wave phase case), it is possible to select the „1ST CASE“ in the drop-down menu, click on „Select >>“ and enable the „Output as bus“ option. Once the process is done, the simulation can be run, which will send the selected data to six image generators which are responsible for image projection onto the projection plane. Unfortunately, the ship deck motion database could not be implemented on time into the experiment setup due to ROSIE challenges, so the flight test experiments with ship deck movement could not be performed in time span specified for this thesis.



## 4 PILOT WORKLOAD ASSESSMENT OF THE SIMULATED SHIP DECK LANDING PROCEDURE

### 4.1 Experiment overview – „Human-in-the-loop“ simulation

Since this Master's thesis is a part of a HELIOP project as it is already mentioned in the introduction part, it has to be acknowledged that the following flight tests were conducted in cooperation with the fellow TUM Helicopter technology department researchers.

The simulator tests that will be described in the section 4.3 will consist of three phases divided respectively in navigation to ship phase, descending to ship phase and landing phase. The idea behind this experiment is to investigate the workload that non-professional pilots must invest while conducting the helicopter landing procedure which is a pretest for creating a fully operational test setup for professional pilot simulator tests in the future. Potential outcomes of the experiment will be used to support future development of the “Passenger Pilot in the Loop” future air vehicle procedures. The experiment itself will examine the possibility for the non-professional pilot to react on his own in case of emergency (malfunction of the Automated Flight Control System) by following the commanded values for cyclic roll. The values which will guide the pilot to the landing location will be displayed on a Primary Flight Display (PFD) or on a Head Mounted Display (HMD) of the ROSIE in a way a pilot can adapt to the situation and follow the commanded values intuitively. Previous work on this topic inside the HELIOP project resulted with a flight controller design [13] for the navigation and descent phase which enables the assistance to the pilot in a manner of displaying the commanded value on a PFD and HMD equipment, but no tests for the landing phase itself were conducted. To challenge the landing phase procedure, a ship deck in motion had to be modelled which is the reason why the SCONE database Simulink model was designed to support the future HELIOP project work. To set the foundation for the future work, the landing phase pilot workload assessment without any assistance has to be examined first. The first step is to examine and compare the difference in invested workload while landing on a reference landing spot - ADS-33 Task Element Landing, and on a steady ship deck without any motion.

## 4.2 Pilot workload research hypotheses

Handling the helicopter is a demanding task, especially when it comes to the landing part. Since the future work of the HELIOP project will deal with the design of landing assistance systems, analyzing the pilot's workload is considered a good metric to measure the improvement of the work as the project evolves. To investigate the amount of pilot's workload invested in different ship deck landing conditions, previously described tests flights were designed. Furthermore, to design the tests and decide about the data that should be analyzed after the tests were conducted, two directed hypotheses were set up to support the following research:

*1st hypothesis:* „The amount of pilot's workload invested while landing on the ADS-33 Mission Task Element Landing will be lower than the amount of workload invested while landing on a steady ship deck (no motion).“

*2nd hypothesis:* “The amount of pilot's overall workload while using the HMD in the experiment will be lower than the amount of workload invested while using the PFD.”

To analyze the hypothesis, a subjective and objective quantitative analysis will be conducted. To conduct a subjective qualitative analysis, a specific set of questionnaires were designed. The questionnaires itself will be described thoroughly in section 4.4. Despite many techniques developed for evaluating pilot workload in flight, subjective assessment by experienced pilots is still considered one of the most reliable methods by far. Since all the tests are of statistical significance, a one-tailed t-test will be used to check whether the hypothesis is rejected or not on a 0.05 significance level.

Nevertheless, for the purposes of discussion and detailed qualitative analysis, a quantitative analysis will be conducted by comparing the recorded pilot stick input data of both landing scenarios.

### 4.3 Flight trials procedure

Since there were several different task elements planned for the flight trials, a very specific order of conducting the task elements had to be predefined. To keep the flight trials well organized and straight-forward, a specific test procedure plan was designed. The test plan will be presented in the following numbering list in the same order the test procedure is designed, which will be followed with the explanation of every task element and procedure included.

#### 1. Task element: Visual reference flight

- 1.1. Task element: Visual reference flight without using PFD or HMD
- 1.2. Task element: Visual reference flight using the PFD only
- 1.3. Task element: Visual reference flight using the HMD

#### 2. Task element: PFD Commanded values (Navigation phase)

- 2.1. Task element: PFD Commanded values: *ROLL*

#### 3. Task element: HMD Commanded values

- 3.1. Task Element: HMD Commanded values: *ROLL*

- I) *Debriefing: Simulator Sickness Questionnaire*
- II) *Debriefing: Pilot Workload Questionnaire (Task Element: Visual reference flight, Task Element: PFD Commanded values, Task Element: HMD commanded values)*
- III) *Debriefing: Pilot Biography Questionnaire*

#### 4. Task Element: Descent and Landing

- 4.1. Task Element: Landing on the ADS-33 training platform (*Straight-in approach*)
- 4.2. Task Element: Landing on the ship-deck without motion (*Straight-in approach*)
- IV) *Debriefing: Pilot Workload Questionnaire (Task element: Landing)*

The first task element (Task Element: Visual Reference Flight) serves as a reference flight for the pilots to get familiar with the simulator environment, including the PFD and HMD. This task element is designed to last for 150 seconds during which the pilots are supposed to fly a straight forward path while maintaining the speed to 80 Kts and hold the initial altitude while flying without using PFD or HMD, using the PFD only, and using the HMD only respectively in every subtask element.

The following two Task Elements (PFD Commanded values and HMD Commanded values) are designed as a semi-autonomous flight scenario. In every task element, the pilot had to follow one commanded value, respectively cyclic pitch and cyclic roll. The values were displayed to the pilot in the HMD screen or on the PFD depending on the task element which can be observed in Figure 22. All the other commands, except the value that the pilot had to follow were handled by the ROSIE. Every task element is designed to last 150 seconds during which the pilots will be guided to make a 90° turn, followed by the straight in approach to the ship deck. Nevertheless, since the controller providing the commanded value for the navigation and descend phase wasn't developed for providing the commanded value during the landing phase, the flight-naïve pilots [14] were not asked to land in this task element.

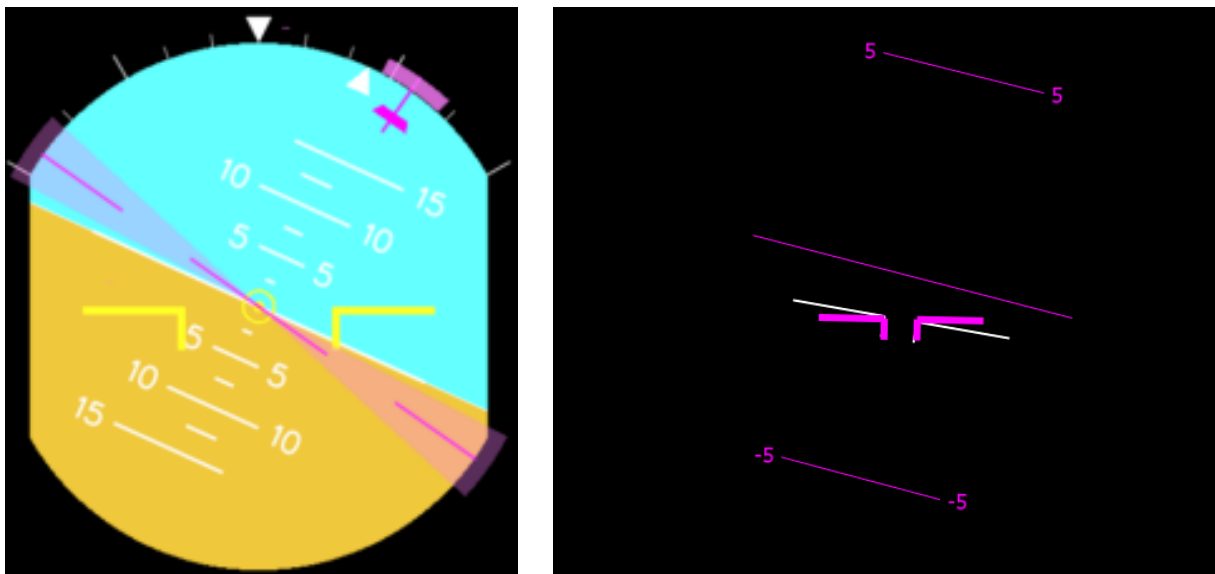

**Figure 22** Experimental display design for Primary Flight Display (PFD) and Helmet Mounted Display (HMD)

The final point of the second experiment phase ends when the rotorcraft reaches the preset waypoint. During the Task Element: Commanded roll PFD and Task Element: Commanded roll HMD an input forcing function signal [15] will be given to the pilot through the modified PFD.

Unlike the previous two task elements where the pilot had to use only one command and follow the commanded value, there will be no such assistance to the pilot in the Task Element: Landing which means that the pilot will have absolute command over the helicopter and no commanded assistance values will be displayed on a PFD.

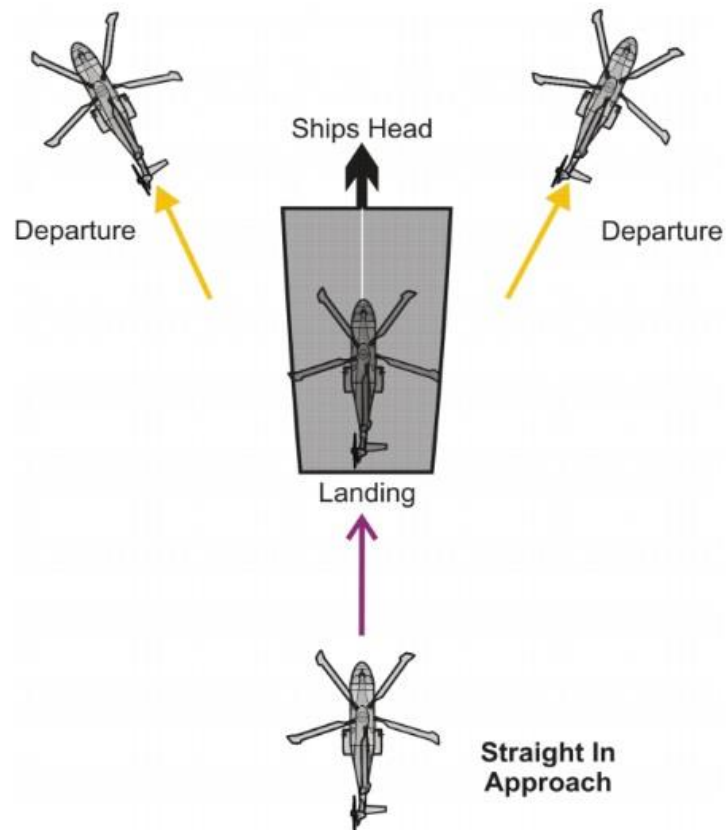

**Figure 23** Straight in approach to the ship deck [16]

Furthermore, Task Element: Landing will begin with the helicopter positioned on the ground, from where the pilots are supposed to fly to the ADS-33 landing platform, perform a straight-in approach and land, followed by a take-off and maneuvering to the ship located in Tegernsee where they are once again supposed to land on a ship deck. A very important fact which will be considered later in the analysis section is that the landing area of the ADS-33 landing platform is almost twice the size of the ship deck landing platform.



**Figure 24** ADS-33 landing platform

It is also important to mention that no wind was simulated during the flight trials. Even more, the test scenario was flight in day conditions, without fog with 10 km visibility, which was a reason to conduct a straight-in approach to the landing spot. The pilots had a briefing before every experiment, where they were introduced to the following task element details they were about to face and the commanded values they were supposed to follow to perform the task successfully. Upon the completion of the task element, every pilot had to go through the

debriefing process where the pilots were asked to answer the questions from the subjective workload questionnaires for the task elements they just completed, together with the simulator sickness questionnaire. The questionnaires will be described in the section 4.4 and the data collected from the questionnaires was used to conduct the qualitative analysis of the workload based on the subjective pilot rating and to analyze the influence of the fatigue and sickness on the workload level results. To ensure strict and well organized flight-test procedure, specific test-cards were designed as “check-lists” to enable easier overview of the experiment’s phases.



**Figure 25** ROSIE visualization of DDG-51 type ship, rotorcraft landing deck

Furthermore, all the pilot's commanded input values from the cyclic and the collective pitch stick were recorded using the predefined MATLAB function, which allowed further quantitative analysis. The quantitative analysis procedure will also be described more thoroughly in the continuation of the work. There were ten experiment participants in total, all of them current members from the Technical University of Munich. Most of them had some level of previous experience with ROSIE, which could potentially influence the subjective workload results, so one more questionnaire regarding the pilot's biography was designed to connect the individual pilot qualities with the workload level rating.

### 4.3.1 Input forcing function signal

To simulate the disturbances the pilots are usually experiencing while flying the rotorcraft in real scenario as vibrations which could be the result of aerodynamic turbulences, rotorcraft's engine, wind gust and similar effects which are not present in the simulation environment, an input forcing function was designed [15]. Five different input signals were prepared for the roll tracking task experiment, all of them defined as a sum of sines with general form

$$i(t) = \sum_{k=1}^n A_k \sin(\omega_k \cdot t + \phi_k) . \quad (2)$$

Different signals had different values of amplitudes  $A_k$ , frequencies  $\omega_k$ , and phase shifts  $\phi_k$ . The signal used, named signal C1, was defined in [15] according to [17]. The input forcing function signal used is shown in Figure 27 and it represents a pseudo random signal for the pilot. The input forcing function signal was added on a commanded roll signal the pilots are supposed to follow in the mission task elements previously described in section 4.1 and it was displayed to the pilots on the PFD and HMD. The signal was triggered by switching on the guidance signal on the command panel above pilot's head in the cockpit and it starts 10 seconds after the switch is turned on, giving some time for pilots to prepare.

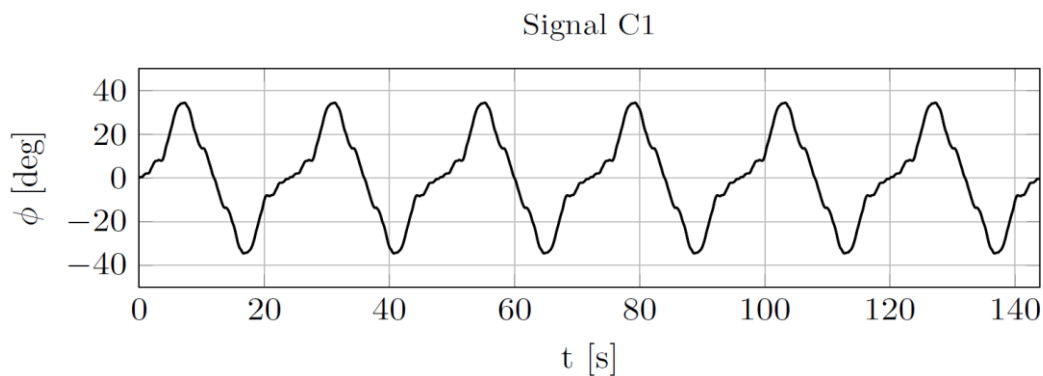

**Figure 27** Input forcing function signal used for the commanded roll flight test experiments [15]



### 4.3.2 Primary flight display setup

For the purpose of conducting the experiments at the ROSIE simulator in general, the PFD was designed to be visible to the pilots which would allow them to follow the magnitudes and spectral properties of the commanded roll input signal for the set distance of the pilot's eye from the PFD [15]. Main component of the PFD the pilots are supposed to be focused on during the experiments is the attitude director indicator (ADI). ADI includes visual information of input forcing function, a roll command signals that pilot should follow and the actual roll angle value. This signal is driving the position of solid magenta line, a horizontal line as well as the vertical magenta line at the top of ADI. Since pilots for precise flight tasks are also following the white triangle at the top of ADI, an extension of this triangle from its lower side in magenta color was also introduced. This way the pilot can precisely visualize the error, how far is the actual roll attitude of the helicopter (given with white triangle) to the commanded roll attitude. It is also important to mention that the ADI is enlarged from its original size to enable smaller values of disturbances in roll to be easily visible to the pilot.



Figure 28 Primary flight display used for the experiment

Additional elements introduced to the display are the borders of desirable value of the error as a transparent magenta area around the solid magenta lines. If the pilot manages to keep his actual roll in this area, then his response would correspond a level 1 handling quality of the task. This way the pilot can simultaneously have a visualization how good is his performance and adapt to it. Similar elements were introduced by Efremov [17,18] and Schuck [19] in their experiment setup. Further explanation of the ADI elements important for this mission task element follows after the Figure 29.

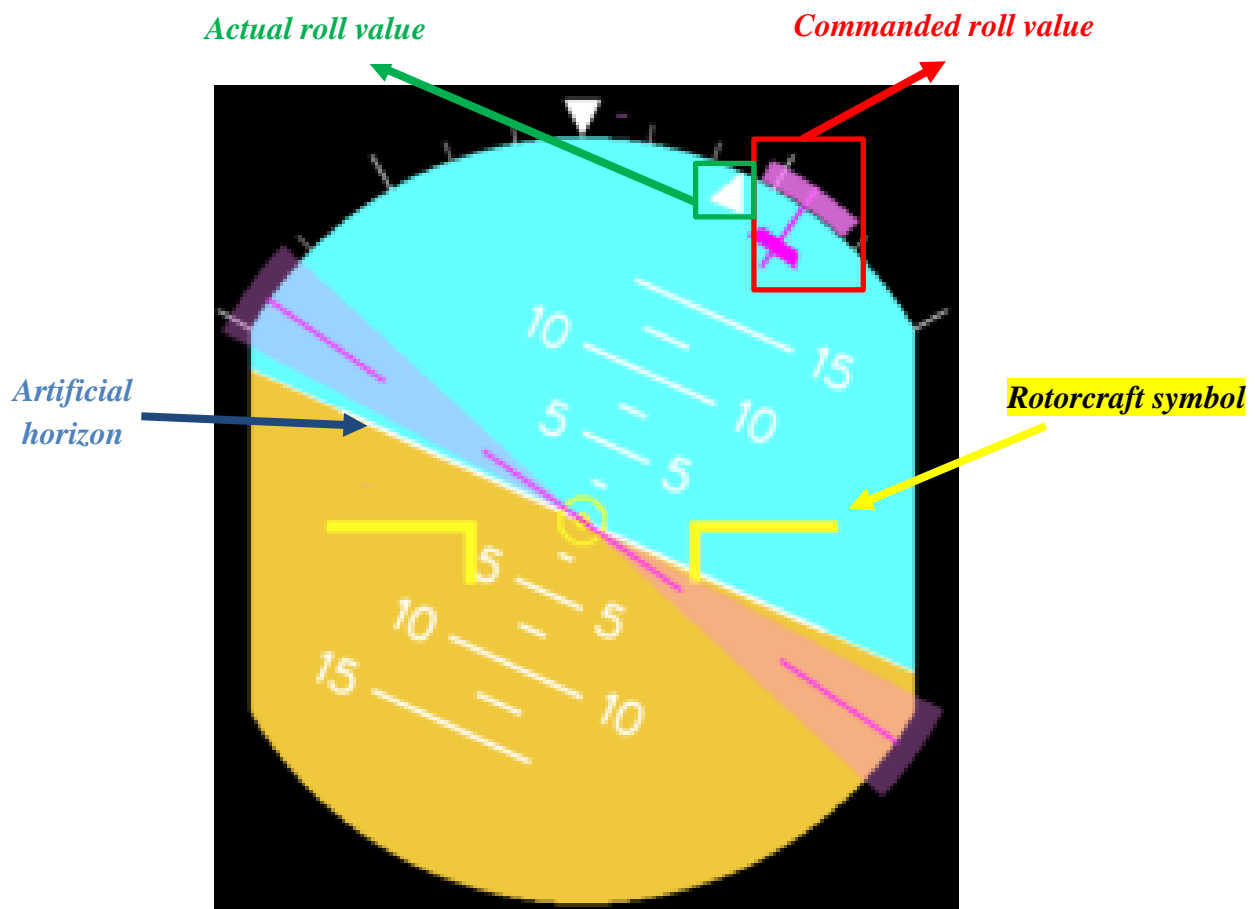

**Figure 29 PFD attitude director indicator (ADI) with explanation**

A magenta colored symbol marked with red box presents the “Commanded roll value” that the flight naïve pilots had to follow to successfully complete the mission task element. The roll command is also presented by the horizontal magenta line in the center of the ADI, giving a visual reference to the artificial horizon to the pilot. The magenta commanded roll value derived from the flight controller providing the guidance and assistance to the waypoint [15], with the input forcing signal added on as discussed previously in this section.

To follow the magenta symbol, flight naïve pilots had to align the white triangle pointing upwards, marked with a green box presenting the “Actual roll value” of the rotorcraft as accurate as they were able to.

The artificial horizon rotates relatively to the aircraft attitude symbol marked with yellow color which stays in the same position as in Figure 29 independently from the rotorcraft attitude. Due to that fact, a white triangle symbol marked with green box in Figure 29 rotates to the right when the pilot's cyclic stick is turned to the left. Meaning that in this situation displayed in Figure 29, flight naïve pilots found it counterintuitive to steer the cyclic stick to the left, which is the right cyclic stick input if the commanded value is to be followed. This effect will be discussed more thoroughly in the section 5.4.

When it comes to the HMD ADI, the artificial horizon rotates with respect to the pilot's head motion since the HMD is fixed to the pilot's head, but the rotorcraft symbol is not static, meaning that it rotates with respect to the artificial horizon, opposite of the PFD ADI case.

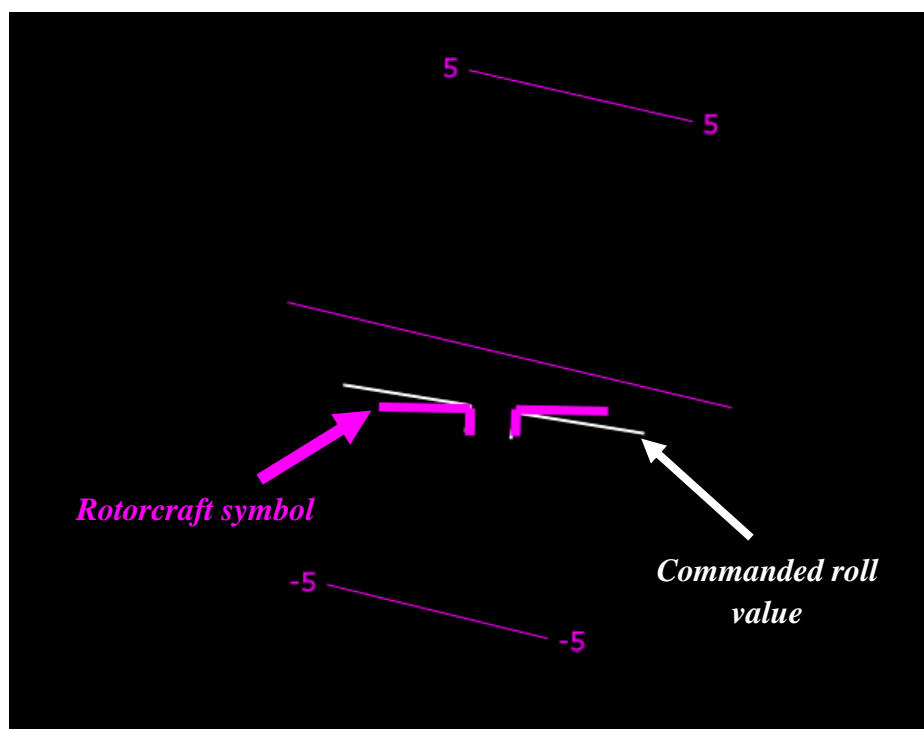

**Figure 30** HMD attitude direction indicator (HMD ADI) with explanation

## 4.4 Quantitative analysis – subjective workload assessment

### 4.4.1 Pilot workload rating questionnaire

To conduct the qualitative analysis of the invested pilot workload a specific questionnaire was designed. The questionnaire that will be shown a little bit later derived from the Bedford Rating scale which is a uni-dimensional rating scale designed to identify operator's spare mental capacity while completing a specific task. It is assessed by using a hierarchically ordered logical decision tree that guides the operator through a ten-point rating scale. Each point of the scale is accompanied by a text block with the description of the associated level of workload and it was originally developed for pilots. The Bedford Workload Rating Scale is a modification of the Cooper-Harper rating scale [20]. The purpose of the Bedford Rating scale is to determine whether it was possible to complete a task to assess whether the workload was tolerable for the task and if workload was satisfactory without any reduction. The advantages of the Bedford rating scale lie in its simplicity, the scale is simple, quick and easy to apply in various situation to assess task load in high workload environments. Furthermore, it is intuitive, so it works well for explaining the test results to the uninitiated and it is well accepted by most pilots.

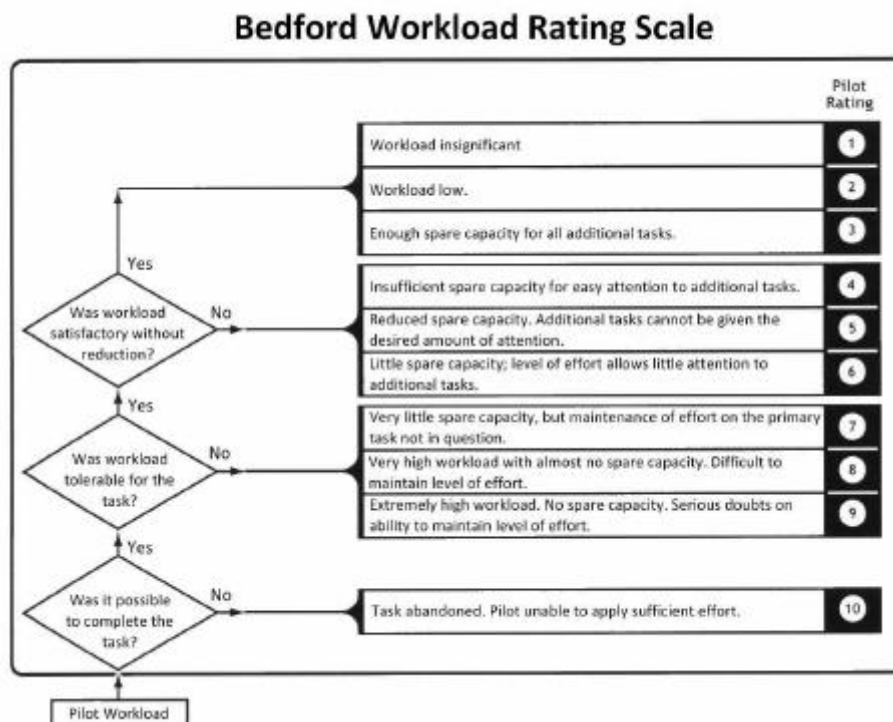

Figure 31 Bedford workload rating scale [20]

The decision tree makes the rating easier by making sequential decisions. The main disadvantage lies in diagnosticity, once a problem is identified, additional techniques are required where the exact problem lies. Since the volunteers for this experiment are flight naïve pilots, it was decided to modify the Bedford rating scale by transferring it to the Likert scale [21]. The Likert scale was originally developed due to the difficulty of measuring attitudes, character and personality traits and transferring these qualities to a quantitative measurement scale for data analysis. The original Likert scale is also a uni-dimensional scale which is used to answer the questions in the questionnaire by five generic answers. The scale is set from 1 to 5 where every answer has its own description in the following way:

- 1 – strongly approve
- 2 – approve
- 3 – undecided
- 4 – disapprove
- 5 – strongly disapprove

Using Likert scale as a reference, a reduced complexity Bedford rating scale was developed specially for the purposes of the experiment with somewhat adjusted unidimensional scale from 0 to 4. The description of the values is defined by the following list:

- 0 – Insignificant workload
- 1 – Very low workload
- 2 – Low workload
- 3 – High workload
- 4 – Very high workload



**Figure 32** A rating scale developed for the purposes of the HELIOP project flight test analysis

Once the workload evaluation rating scale has been set up, three precise statements were defined for the pilots to answer by giving their subjective rating of the workload necessary to complete the landing task. The same procedure regarding the statement definition was also followed while creating the statements for the other task elements in the experiment, but the order of statements set in the questionnaire had to be discussed carefully to avoid pilot's confusion while dealing with the questionnaire. To keep the whole questionnaire easy to follow and intuitive, the following set of statements regarding the task elements of the experiment is presented in the table below. It is important to notice that the set of statements regarding the landing phase was asked right after the questions regarding the first two phases for semi-autonomous flight in navigation and descending phase. As it was previously mentioned regarding the subjective workload data analysis, the impact of all the task elements on the workload rating will be brought to discussion. For that purpose, in the last part of the following table, the pilots were also asked about their subjective preference between using the HMD or PFD in the navigation and descent phases while completing different task elements. It is also worth mentioning that the assessment scale is in that case somewhat different. To be more specific, the scale is again uni-dimensional, but the numerical values are not the same as in the workload assessment scale:

- -2 – PFD
- -1 – Rather PFD
- 0 – No preference
- 1 – Rather HMD
- 2 - HMD



**Figure 33** Rating scale developed for the HELIOP project  
PFD vs. HMD pilot preference

**Table 3 Pilot workload rating questionnaire with all mission task elements**

<b>1 Pilot Workload Assessment – Task Element: Visual reference flight</b>		
1.1	<p>I was able to do the TE: <b>Visual reference flight</b> by looking outside the helicopter only (not using PFD)</p> <p><i>Remark:</i> 150 sec flight straight forward, keep speed to 80Kts and hold altitude</p>	
1.2	<p>I was able to do the TE: <b>Visual reference flight</b> by using the PFD only</p> <p><i>Remark:</i> 150 sec flight straight forward, keep speed to 80Kts and hold altitude</p>	
1.3	<p>I was able to do the TE: <b>Visual reference flight</b> by using the HMD</p> <p><i>Remark:</i> 150 sec flight straight forward, keep speed to 80Kts and hold altitude</p>	
<b>2 Pilot Workload Assessment – Task Element: PFD Commanded values</b>		
2.1	<p>I was able to do the TE: align <b>commanded roll</b> with actual pitch by giving cyclic inputs.</p> <p><i>Remark:</i> 150 sec flight, 90° to target</p>	

3 Pilot Workload Assessment – Task Element: HMD Commanded values		
3.1	<p>I was able to do the TE: align <b>commanded roll</b> with actual pitch by giving cyclic inputs.</p> <p><i>Remark:</i> 150 sec flight, 90° to target,</p>	
4 Preference: PFD/HMD Preference for each TE: PFD vs HMD		
4.1	<p>For TE: align <b>commanded roll</b> I prefer displayed information via...</p>	
5 Pilot Workload Assessment – Task Element: Landing		
5.1	<p>I was able to do the TE: <b>Landing on the MTE Landing</b></p> <p><i>Remark:</i> 300 sec flight, Direct straight in approach disturbance 0</p>	
5.2	<p>I was able to do the TE: <b>Landing on the steady ship deck</b></p> <p><i>Remark:</i> 300 sec flight, Direct straight in approach disturbance 0</p>	



#### **4.4.2 Attitude direction indicator (ADI) coloring questionnaire**

Since the ADI presented in both PFD and HMD plays a very important role in displaying all the important information required to complete the mission task elements, it is considered to be a very important factor in the workload assessment for the purposes of this master's thesis. To be able to analyze possible influence of ADI coloring on the assessed workload, a following set of statements were designed for the flight naive pilots to assess it by their personal feeling by continuing the statements with the answers „I agree“, „I rather agree“, „I rather do not agree“ and „I do not agree“.

The following questions displayed in Table 4 are focused on the effect of ADI coloring of actual and commanded value of roll presented both in PFD and HMD as explained previously in section 4.3.1 is mainly focused on the influence of the ADI coloring on the situational awareness and pilot's perception of displayed individual information. The rest of statements in this part of the questionnaire is focused more specifically on the ADI presented symbology line style and line thickness with the purpose of possible future improvements. This part of the questionnaire will prove to be useful later in the section 5.4 while discussing the workload assessment.

**Table 4 Attitude direction indicator (ADI) coloring questionnaire**

<b>6 The coloring of the ADI (actual and commanded) presented on the PFD...</b>					
6.1	...simplifies the perception of individual information	I agree	I rather agree	I rather do not agree	I do not agree
6.2	...increases my Situational Awareness	I agree	I rather agree	I rather do not agree	I do not agree
6.3	...is too colorful	I agree	I rather agree	I rather do not agree	I do not agree
6.4	...enables to clearly distinguish between the presented content	I agree	I rather agree	I rather do not agree	I do not agree
<b>7 The coloring of the ADI (actual and commanded) presented on the HMD...</b>					
7.1	... simplifies the perception of individual information	I agree	I rather agree	I rather do not agree	I do not agree
7.2	... increases my Situational Awareness more than PFD	I agree	I rather agree	I rather do not agree	I do not agree
7.3	...could contain more colors	I agree	I rather agree	I rather do not agree	I do not agree
7.4	...could contain more lines with different thickness	I agree	I rather agree	I rather do not agree	I do not agree
7.5	...could contain more line styles.	I agree	I rather agree	I rather do not agree	I do not agree

### 4.4.3 Simulator sickness questionnaire

Simulator sickness in high fidelity visual simulators is a by-product of modern simulation technology according to [22]. Due to its symptoms as nausea and nausea-related symptoms, vertigo, headache, blurred vision etc. it is considered as a possible disturbance factor to the workload assessment result analysis. Even more, it is proven that the simulator sickness negative effects tend to become stronger over time spent in the simulator, especially in cases when the simulator operators use HMD to complete the given task. Since the pilots had to complete five task elements prior to the landing task elements and they have been using the HMD in some of the task elements, the simulator sickness side effects may not be neglected. To gather some data about the negative effects and the level of fatigue experienced during the experiment scenario, a Simulator Sickness Questionnaire [22] was given to the pilot's right after the end of the experiment, since the simulator sickness side effects also tend to decrease over time, once the pilot is not in the simulator environment anymore. From the image below, it can be observed how the pilots are asked to evaluate the most common simulator sickness effects with answers like „none“, „slight“, „moderate“ and „severe“. By adding numerical values from 0 to 3 respectively to the answers, a statistical analysis was conducted which resulted with a bar plot which will be also shown in the result analysis section later in this master's thesis.

# Simulator Sickness Questionnaire

Kennedy, Lane, Berbaum, &amp; Lienthal (1993)

Pilot ID: \_\_\_\_\_ Task ID: \_\_\_\_\_

Datum: \_\_\_\_\_ Uhrzeit: \_\_\_\_\_

Instructions: Circle how much each symptom below is affecting you right now.

1) General discomfort.....	None	Slight	Moderate	Severe
2) Fatigue.....	None	Slight	Moderate	Severe
3) Headache.....	None	Slight	Moderate	Severe
4) Eye strain.....	None	Slight	Moderate	Severe
5) Difficulty focusing.....	None	Slight	Moderate	Severe
6) Salivation increasing.....	None	Slight	Moderate	Severe
7) Sweating.....	None	Slight	Moderate	Severe
8) Nausea.....	None	Slight	Moderate	Severe
9) Difficulty concentrating.....	None	Slight	Moderate	Severe
10) Fullness of the Head.....	None	Slight	Moderate	Severe
11) Blurred vision.....	None	Slight	Moderate	Severe
12) Dizziness with eyes open.....	None	Slight	Moderate	Severe
13) Dizziness with eyes closed.....	None	Slight	Moderate	Severe
14) Vertigo*.....	None	Slight	Moderate	Severe
15) Stomach awareness**.....	None	Slight	Moderate	Severe
16) Burping.....	None	Slight	Moderate	Severe

Figure 34 Simulator sickness questionnaire (SSQ) [22]

#### **4.4.4 Biography questionnaire**

As an addition to the previous questionnaires, it was found important to design one more questionnaire to obtain some better knowledge about the personal characteristics of the pilots who volunteered for the experiment. The questionnaire had two sections, the first one being more focused on demographic and physical characteristics, and the second one being focused on the previous flying experience. In the first section, pilots were asked to provide information about their age, gender, eye-vision quality (whether they wear glasses or contact lenses), possible color-blindness issues, whether they are right-handed or left-handed and their education. In the second section of the questionnaire they were asked to share some information about their previous experience with the simulators, how many hours do they have on the simulator in a lifetime and in the past year, whether they have a flying license or not etc. The data obtained through the biography questionnaire was also used later for better understanding of the results obtained via subjective workload assessment questionnaires.

## 5 FLIGHT TEST EXPERIMENT RESULTS

### 5.1 Subjective workload assessment results for Visual reference and Commanded roll task elements

The following section will deal with the analysis of the subjective workload assessment results derived from the pilot workload rating questionnaires presented in the section 4. The following plot in the Figure 35 contains the pilot workload assessment ratings for the first five task elements, respectively Task element: Visual reference flight without using PFD or HMD, Task element: Visual reference flight using the PFD only, Task element: Visual reference flight using the HMD, Task element: PFD Commanded values: *ROLL* and finally Task element: HMD Commanded values: *ROLL*. The results that arise from the following plot are the mean and standard deviation values obtained from the workload rating questionnaires based on answers provided by 10 flight naïve pilots in total. The tests were conducted in three sessions during three working days. There were 6 recordings made per pilot, resulting with 60 recordings in total for the task elements presented in the section 4.

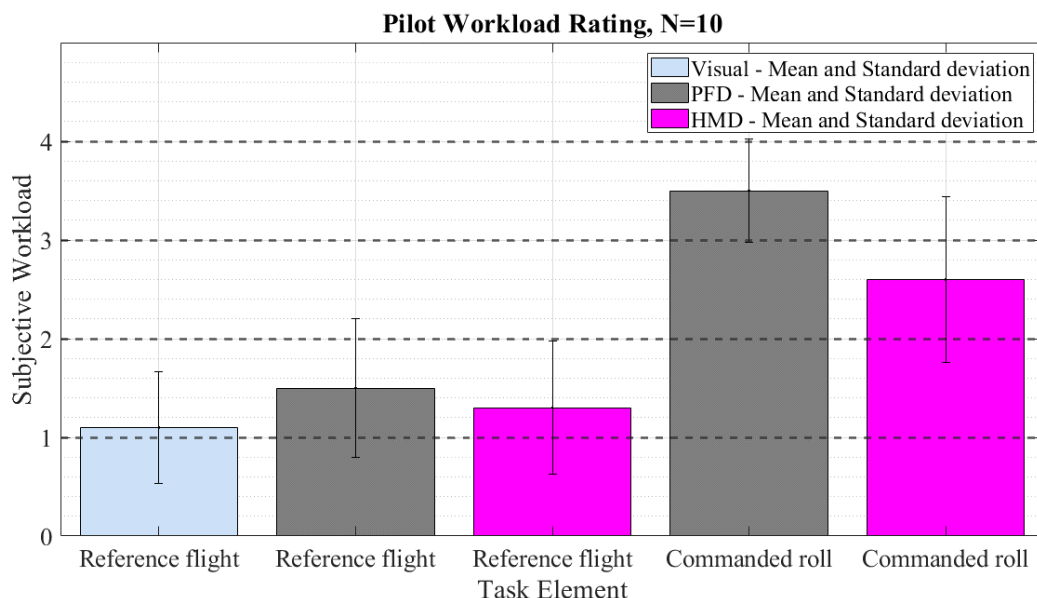

**Figure 35 Pilot workload rating assessment for the Task elements 1.1, 1.2, 1.3, 2.1 and 3.1**

Light blue color in the plot represents the Task element 1.1 where the flight naïve pilots were not supposed to use any instruments during the flight, followed by the light grey representing the task elements where the PFD was the only instrument allowed to use. Magenta color in the bar chart represents the usage of HMD in task elements.

Since the first three task elements served as a baseline since the pilots had to fly straight while maintaining the set velocity and height using only the cyclic stick, it was expected that the workload in those three task elements will be lower than in the following two task elements where the pilots had to follow a commanded roll signal with the input forcing function added on. If the first three task elements are grouped, it can be concluded how the workload is generally assessed between grades 1 and 2 representing respectively “Very low workload” and “Low workload” compared to the task elements with commanded roll values where the workload is somewhat higher, generally assessed between 3 and 4 representing respectively “High workload” and “Very high workload”. Even though it was previously explained in the section 4.4.1. that the workload rating scale designed specifically for this purpose derived from the Bedford rating scale reduced to the Likert scale with grades from 0 to 4 due to simplification of the assessment process for the flight naïve pilots, it must be mentioned that the flight naïve pilots have had several complains on the workload assessment scale “rigidity”, often finding it hard to decide between two values in the workload assessment process. Questions regarding the task elements from the workload assessment questionnaire were asked right after the completion of the task element, to avoid the influence of the following task elements on the assessment. That means that the pilot flew the task elements, which was followed by giving the assessment for that task element right after the completion of the task element, after which the pilot was asked to fly the next task element simulation.

There is also a very interesting fact in the workload assessment plot if the task elements in which the PFD is used compared to the task elements in which HMD was the main instrument in which the flight information is presented to the flight naïve pilots. There is a significant drop in the workload assessment in task elements including HMD with respect to the task elements which used the PFD for displaying the information, both for the reference flights task elements and commanded roll task elements. At this moment, it is important to mention that it was considered that the flight naïve pilots may be in some way influenced by the order of using the PFD or HMD while making the workload assessment which could affect the results. To solve this potential issue, it was decided that the order of completing the task elements including

commanded roll values must be randomized. The randomization was achieved by switching the order of conducting the task elements 2.1 and 3.1 after every 5 flight naïve pilots have completed the test procedure. The influence of PFD and HMD on the workload assessment results will be discussed separately after the following results for the landing workload assessment are analyzed.

Upon the completion of the first five task elements, with results presented in the Figure 29, the pilots were asked to step out of the ROSIE cockpit and have a debriefing round. The debriefing round included the pilots to fill in the Simulator Sickness Questionnaire and a biography questionnaire, together with the PFD vs. HMD preference questionnaire for the previously completed task elements. Since the flight naïve pilots have already spent approximately 30 minutes in the simulator, it was expected that some simulator sickness side-effects could already be affecting the flight naïve pilots and it was considered important to examine those effects at this point, before the pilots were asked to conduct the task elements for the landing phase.



**Figure 36 Simulator experiment with a pilot-in-the-loop in a Mission Task Element: Commanded roll PFD**



The results regarding the simulator sickness questionnaire will be discussed in the following section, to discuss the flight naïve pilot's physical and mental conditions prior to proceeding to the landing phase task elements.

## 5.2 Simulator Sickness Questionnaire (SSQ) results

Just like it was previously mentioned in the section introducing the Simulator Sickness Questionnaire, due to symptoms as fatigue, nausea and related symptoms as vertigo, headache, blurred vision and eye strain it is considered as a possible disturbance factor to the workload assessment result analysis. Even more, it is proven that the simulator sickness negative effects tend to become stronger over time spent in the simulator, especially in cases when the simulator operators use HMD to complete the given task. By taking the mean values of all the answers provided by the flight naïve pilots, the following plots could be produced, containing the question description on the horizontal axis and the rating scale on the y axis from “none”, followed by “slight”, “moderate” and “severe” intensity.

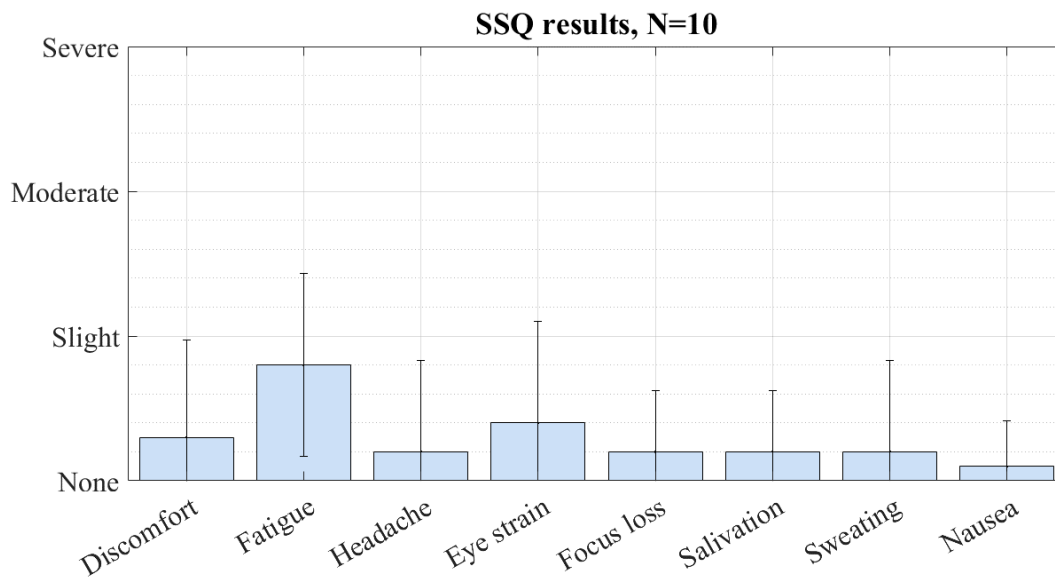

**Figure 37 Simulator Sickness Questionnaire results (1st part)**

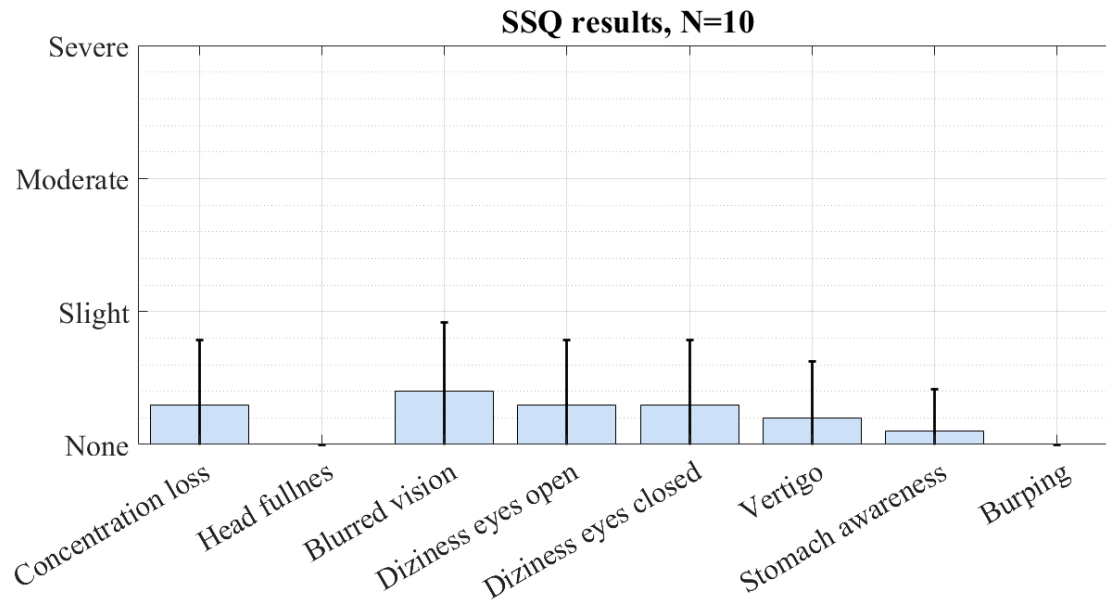

**Figure 38 Simulator Sickness Questionnaire results (part 2)**

If the data from the Simulator Sickness Questionnaire [22] from the Figures 37 and 38 are furtherly examined, it can be concluded that all the symptoms were between “none” and “slight” intensity, with fatigue, blurred vision, eye strain and difficulty concentrating showing the highest values among others. Even though the simulator sickness side effects tend to decrease over time once the pilot exits the simulator environment, those effects must not be neglected in the further analysis. Multiple possible influencing factors on the simulator sickness side effects will be discussed through the analysis, focusing on the PFD and HMD influence. It is already known by [22] that the HMD raises the intensity of the side effects in simulator environment in general, but it is also worth examining the possible influence of the PFD. A more thorough analysis of the possible influences of the PFD and HMD will be brought into discussion in the section 5.4.

Once the flight naïve pilots were finished filling in the simulator sickness questionnaire, they were asked to conduct two more task elements regarding the landing which were expected to be the most demanding task elements among others. Nevertheless, it was important to examine the simulator sickness side effects prior to conducting the landing task elements themselves, since the workload assessment could have even higher assessed ratings due to that fact.

### 5.3 Subjective workload assessment results for the Task element: Landing

The following plot in Figure 39 contains the pilot workload assessment ratings for the last two task elements, respectively Task Element: Landing on the ADS-33 training platform (*Straight-in approach*) and Task Element: Landing on the ship-deck without motion (*Straight-in approach*). Just like the previous plot shown in Figure 29, the results that arise from the following plot are representing the calculated mean and standard deviation values obtained from the workload rating questionnaires based on answers provided by 10 flight naïve pilots in total.

The bar coloring was chosen to be light grey, the same as in the subjective workload assessment coloring plot where it represented the PFD, since the pilots were allowed to use the information displayed on the PFD and look outside the helicopter for a visual reference to the landing point.

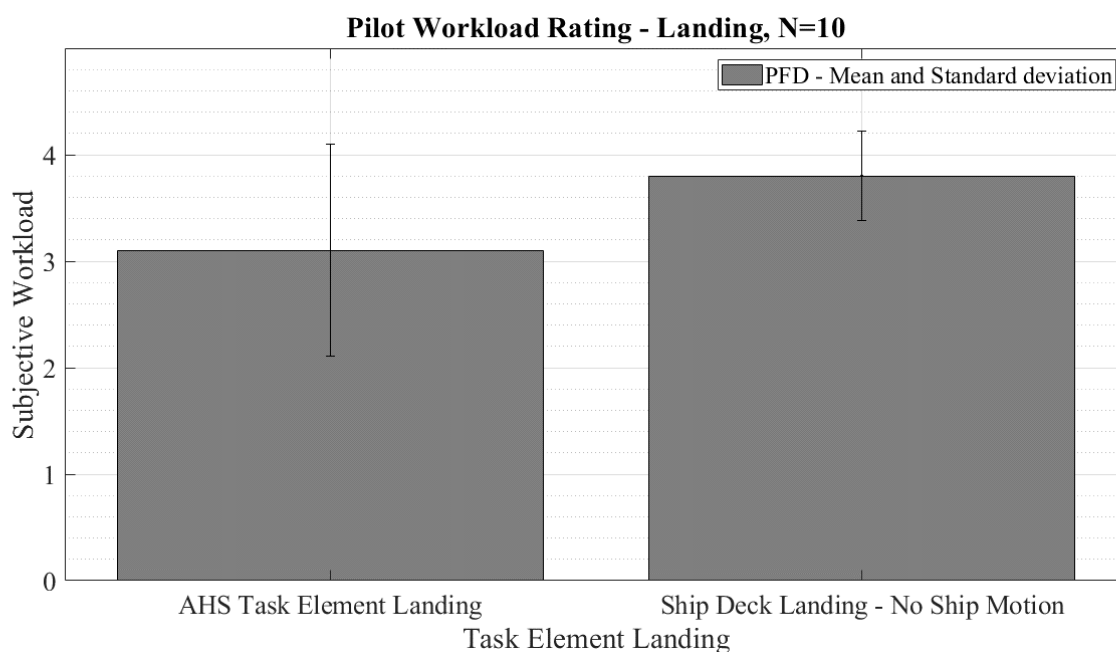

**Figure 39** Subjective workload assessment results for the Task element: Landing

It was mentioned already that the flight naïve pilots had no assistance in terms of navigation to the waypoint such as commanded roll values in previous two task elements, meaning they were completely in control over the rotorcraft while navigating it to the waypoint. The flight naïve pilots were asked to fly straight forward until they reach the vicinity of the ADS-33 landing platforms, followed by a 90° left turn and land *straight-in* on the ADS-33 training platform, repeating the same procedure from the landing platform to the ship deck located in Tegernsee. The *straight-in* approach was found to be hard for some participant to conduct, which caused somewhat different approach to the landing point in some cases. The flight naïve pilots were given only one chance to land, meaning that the landing was considered unsuccessful if the pilots had a crash and they weren't allowed to repeat the landing, but they could proceed to the ship deck landing task. There were bla crashes during the landing task element, bla of them while attempting to land on the training landing point and bla of them while trying to land on the ship deck which could also be influenced by the side-effects of the simulator sickness.

Nevertheless, when it comes to the landing workload assessment, the flight naïve pilots were asked to assess only the landing part of the whole task element which has given the results in the Figure 39. It is interesting to observe the workload ratings for the task elements regarding the landing which are higher than previous ratings regarding the task elements for the reference flights and commanded values task elements. In general, mean assessed values were between “high workload” and “very high workload” which indicates that the landing maneuver is the most demanding one in comparison to the other task elements, which was an expected outcome. It is also interesting to note the workload assessment rating difference between the ADS-33 landing and ship deck landing. By comparing the workload assessment ratings for those task elements, the flight naïve pilots seemed to have more problems while trying to land on the ship deck compared to the ADS-33 landing zone task element even though the ship wasn't set in motion. One of the causes for this assessment rating outcome could be the size of the landing spots, since the ADS-33 landing zone is almost double the size of the DDG-51 ship's landing deck. Another cause for this could also be the distraction caused by the surrounding of the ship, since at the time flight tests were conducted, there was no visual ship wake model integrated to ROSIE, meaning that the water surrounding the ship is being represented as a calm blue surface which could be counterintuitive to the flight naïve pilots.

Furthermore, since the ADS-33 landing platform does not contain any obstacles like walls, compared to the ship deck which is connected to ship's hull, it could influence the way the pilots approach to the landing maneuver and be the cause of higher workload.

To have a deeper insight into the landing workload assessment, the longitudinal and lateral cyclic stick activity during the landing procedure will be analyzed in the section 5.5 to investigate the connection with the assessed workload rating.

It will be very interesting to repeat the flight tests once the DDG-51 ship is set into motion and the water surface visual wake model is implemented and compare the results. Even at this early stage of investigating the flight naïve pilot's ability to land a rotorcraft, it is concluded that the landing task, as expected, requires the highest amount of pilot's workload, which implies the need of dealing with this issue by raising the amount of assistance the pilot can get from the rotorcraft. One possibility that is being considered for the future work is the implementation of the commanded values, just like in the navigation and descent phase introduced in the task elements regarding commanded values presented in this work.

#### **5.4 Preference between the PFD and HMD for the mission task elements**

To gain even more insight in the workload assessment, the pilots were asked to rate their preference between the PFD and the HMD upon the completion of the first five task elements, since the landing mission task element didn't include the HMD assistance. The preference scale was set by the means previously explained in the section 4.1 with values from -2 to 2, where the value -2 represented the absolute PFD preference, -1 rating meaning a slight advantage to PFD, value 0 represented a no preference, 1 slight advantage given to HMD and 2 meaning absolute HMD preference by the flight naïve pilots. Since the preference rating without any further detailed information wasn't considered enough to make a conclusion about the reasons why pilots chose one option over the other, an additional set of specifically designed questions regarding the ADI coloring, line style, line width and visual perception of displayed information on PFD and HMD was asked to the pilots, as presented in the section 4.4.1. Beside the preference ratings, the pilots were also asked to give additional comments regarding this matter, which were considered while analyzing the data and the most interesting of them will be discussed after the obtained data is presented in the continuation of this section. The following

plot presents the amount of chosen answers regarding the preference between PFD and HMD in percentage of total number of given answers. There is also a trend line plotted as a dashed red line which represents the sum of answers for PFD preference compared to the sum for HMD preference answers.

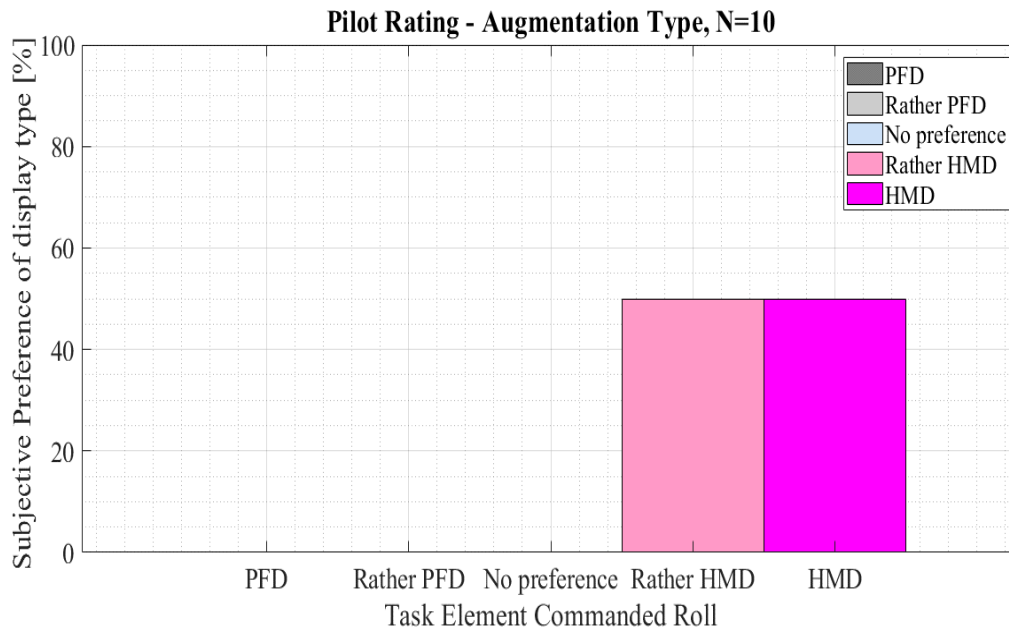

**Figure 40 Preference between the PFD ADI and HMD ADI for the Task Element: Commanded roll**

There is a very interesting fact arising from this plot which is related to the workload assessment ratings the flight naïve pilots have given for the mission task elements. It is already mentioned that there is a slight drop in workload ratings in mission task elements where the pilots were using the HMD to process the flight data during the task elements, as shown in Figure 35. After analyzing the preference plot, it is concluded that the pilots have given a very strong advantage to HMD compared to the PFD. A red colored dashed trend line is a strong indicator of this result. Even though the PFD offers and displays much more information to the pilot than the HMD, which is generally considered beneficial, it turned out that the flight naïve pilots preferred the flight data to be displayed in a simpler manner in terms of HMD.

At this point, it is important to emphasize that the participants were flight naïve pilots, which don't have any professional flight training, and their preference of HMD over PFD could be influenced by the amount of information they were receiving. Meaning that, due to the fact they were supposed to focus on one commanded value of roll, the rest of the data presented in the PFD might have been overwhelming and found unnecessary which might not be the case with the professional rotorcraft pilots.

A step further into the preference analysis is to analyze the details about the chosen preference between the PFD and HMD. The pilots were given one more questionnaire containing more detailed questions about the PFD and HMD ADI coloring, impact of the ADI coloring on the situational awareness, ADI brightness and visual perception of displayed information. Information gathered from this plot will be useful in the future HELIOP projects regarding the improvement of PFD and HMD ADI symbology.

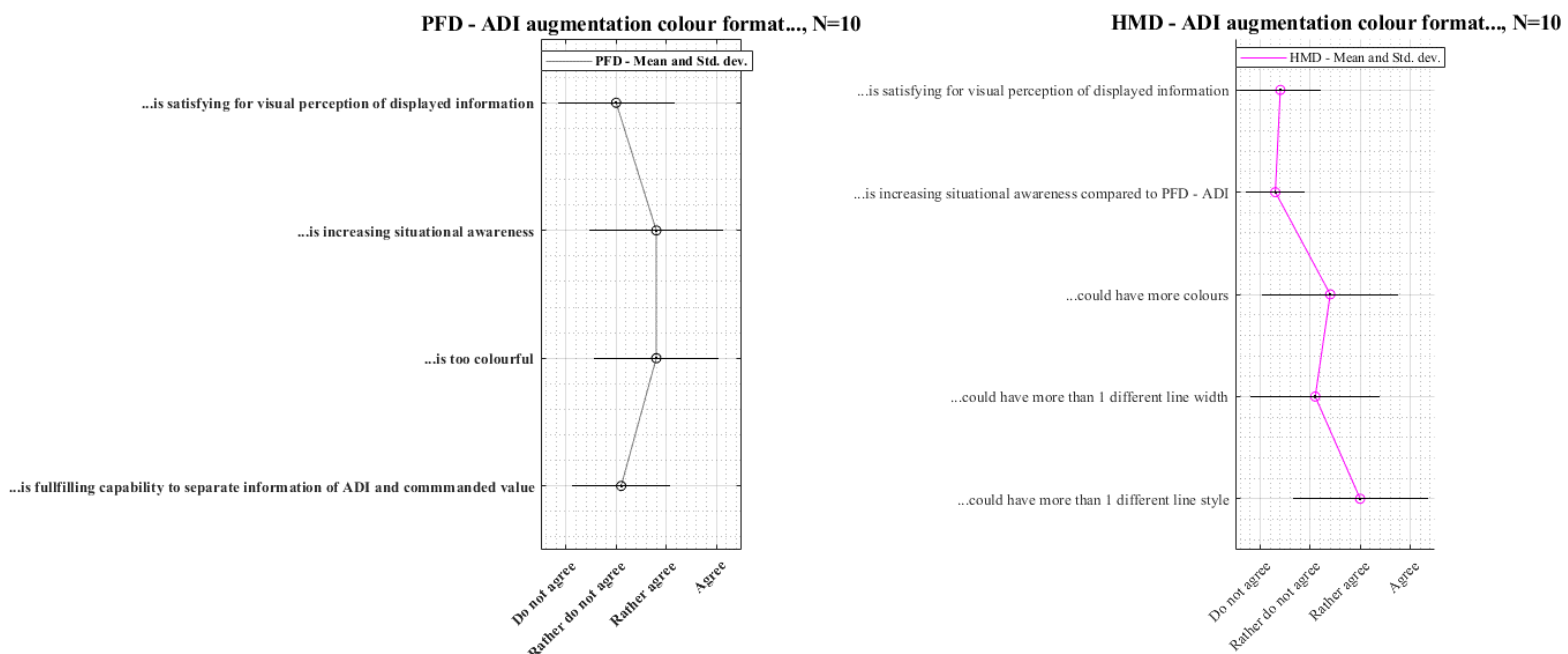

Figure 41 Additional PFD vs. HMD ADI coloring questionnaire

By getting into discussion with the flight naïve pilots after the flight tests were done, regarding the differences within PFD and HMD used to complete the mission task elements, one interesting comment was common for most of the flight naïve pilots who participated in the flight tests. Even though the order of commanded roll mission task elements was randomized by changing the order after every five pilots have completed their flight tests, the flight naïve pilots found the PFD harder to adapt to it, finding it somehow counterintuitive to follow the commanded roll signal in comparison with the HMD mission task element. Further explanation is made with respect to the Figure 29 which is helpful for better understanding.

Another interesting comment regarding this matter was that the flight naïve pilots took some time to adapt to this concept and it required them to stay very well focused on the task. The moment they lost the focus due to mission task element duration, there were cases where the pilot's cyclic stick inputs were given in opposite direction of the direction of commanded roll value.

When it comes to the symbology displayed on the HMD ADI for the same task element including commanded roll values, general opinion of the flight naïve pilots participating in the flight tests was quite opposite, since they found the HMD much more intuitive while trying to follow the commanded value. An explanation is found in a fact that in HMD ADI, the aircraft symbol presented as the thickest magenta colored line in Figure 30, rotates relatively to the horizon bar, just opposite of the PFD ADI where the horizon bar rotated relatively to the aircraft attitude bar which stayed stationary during the operation. This discussion will continue in the following section since it is considered important for the further development of the HMD in the future of the HELIOP project.



## 5.5 Flight test data objective analysis

The experiment is designed to record the output data among which the most important data as commanded roll signal, guided roll signal, actual roll attitude of the rotorcraft, as a response to the pilot's cyclic stick roll input control following (tracking) the commanded roll, as well as the input forcing function. The following figure shows the recording of the first flight naive pilot's flight test, where the plot presented in the upper part of the Figure 42 shows the recording of the Task element: Commanded roll PFD, followed by the plot under it, with the Task element: Commanded roll HMD. The commanded roll recorded signal is presented with a blue line, followed by the red line presenting the actual roll attitude of the rotorcraft. The blue line is a sum of dashed green and black line. Dashed green line presents the „guided roll“ signal since the guidance to the preset waypoint was turned on after the pilots obtained control of the rotorcraft after the beginning of the simulation. A black line displayed in both plots presents the input forcing function signal which was triggered 10 seconds after the guidance switch was turned on. The data presented in the Figure 42 was recorded for every single pilot participating in the flight tests. For the purposes of further data analysis, every recording was processed in a manner that the data taken into analysis started 10 seconds after the guidance switch was turned on, in duration of 144 seconds after that moment [15]. It was important to set the same duration for all the recordings, so the following variance analysis could be done.

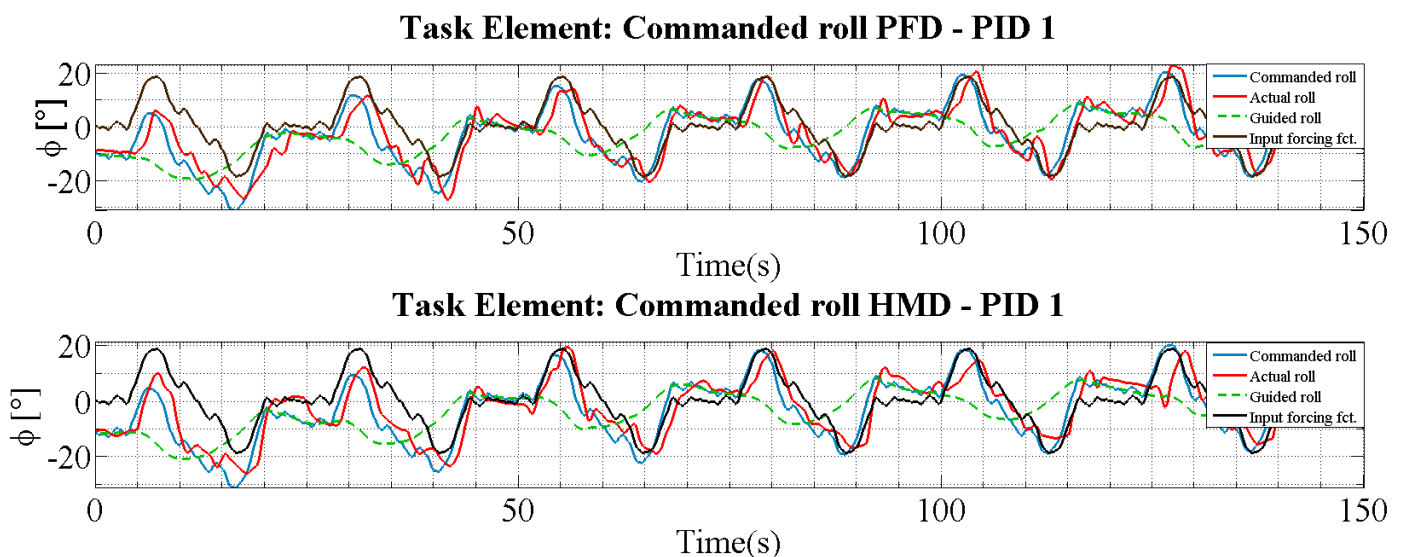

**Figure 42** Example of the flight test recording data for task elements including commanded roll

Once all the recordings were obtained and the data processed in a manner to have the same recording duration for all the pilots, a metric had to be found to compare the quality of conducted task elements for commanded roll. Variance error analysis between the commanded roll signal and actual roll attitude signal over the duration of 144 seconds was found to be a suitable metric for this comparison. After the variance data for all the flight naïve pilots who participated in the flight tests is presented in the Figure 43, the connection between the subjective assessment of invested workload and objective analysis will be discussed.

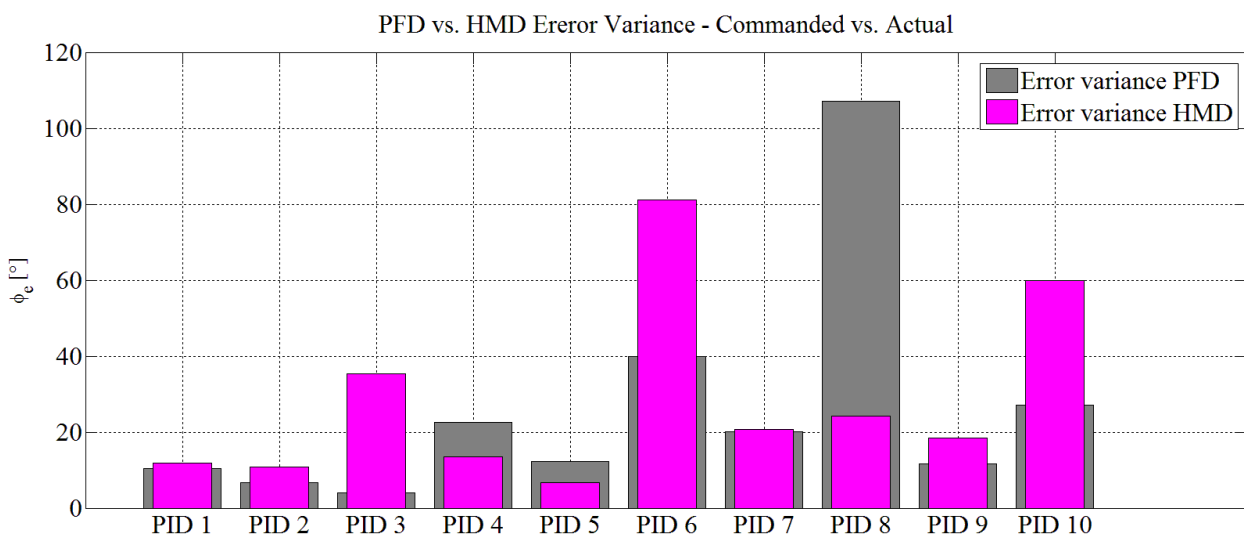

**Figure 43** Error variance comparison between PFD and HMD mission task elements for commanded roll

If variance plots for PFD and HMD are analyzed separately for every pilot, a very interesting fact arises. Namely, for almost every flight naïve pilot, except for one case for the Pilot ID 8, the variance is found to be lower while conducting the task element commanded roll by using the PFD only. Lower variance is a direct indicator of precision, which means that all the pilots performed better and more precise by using PFD. Even though the pilots performed better with PFD, a 5% significance t-test was conducted using MATLAB, which proved that PFD results are slightly better, but a hypothesis cannot be confirmed at a 5% significance level. This effect can be directly brought into connection with the workload assessment and subjective flight naïve pilot's preference analyzed earlier in this master's thesis in section 5.1.

If the results for the subjective analysis from Figure 35 would be compared to the objective variance analysis, it can be observed how the workload was generally subjectively assessed as much lower by using the HMD then by using the PFD while following the commanded roll signal.

The resulting conclusion from this outcome showing how the flight naïve pilots generally performed the task elements following the commanded roll signal slightly better using the PFD. Nevertheless, PFD shows significantly higher workload assessment which indicates that the PFD symbology proved to be better than the HMD symbology for precision flight even though the pilots often complained about the counterintuitive effect of steering the cyclic stick. Even more, there were a lot of comments regarding reduced situational awareness while looking at the PFD compared to the task element where the HMD was used where the pilots mostly commented that they were focused on the symbology, but they had better awareness of the environment around the rotorcraft. Furthermore, if Figure 41 is observed once more, the flight naïve pilots participating in the flight tests have given a good indication that the HMD symbology could be furtherly improved, which is confirmed with the variance results shown in the Figure 43. The HMD ADI improvement is already in consideration inside the HELIOP project, so the PFD and HMD ADI coloring questionnaire was made with the purpose of clarifying the ADI elements which are critical to improve and to serve as an argument in the ongoing discussion.

The following plots which will be presented in the Figure 44 and Figure 46 for the HMD and PFD separately are the recordings made for the visual comparison of the lowest and highest variance respectively for Task element: Commanded roll PFD and Task Element Commanded roll HMD. To avoid possible confusion, the commanded roll signal will be presented with a dashed blue line in both PFD and HMD cases, while the actual roll attitude in PFD case will be presented with thin grey line, used for the representation of the PFD in previous plots. When it comes to presenting the HMD recordings, the actual roll signal will be plotted in magenta, representing the magenta color of the HMD symbology. The plots will be used to visualize the differences between the recordings with the lowest and highest error variances and to furtherly investigate the effects mentioned by the pilots found counterintuitive while following the commanded roll signal.

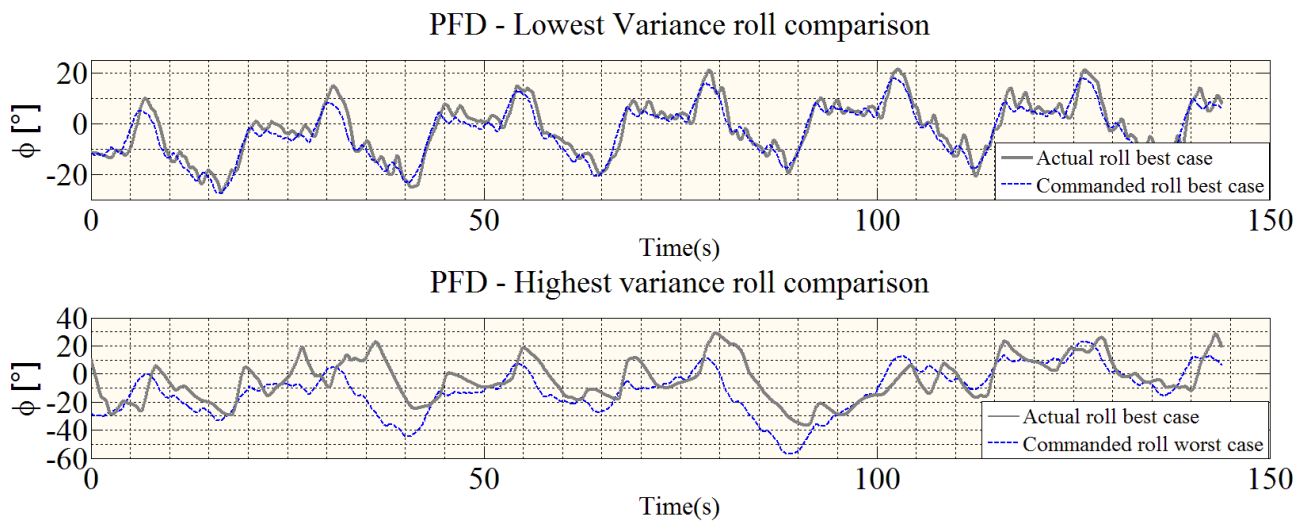

**Figure 44** Actual vs. commanded roll comparison of the recorded data for the lowest and highest error variance flight recordings using the PFD

If the plots in the Figure 43 are compared, it can be observed how the lowest variance recording plot actual roll signal follows the commanded roll signal with small deviations, when compared with the highest variance recording underneath it. The reason somewhat higher reaction time in the highest variance error recording could be the fact that the flight naïve pilot had issues with the “counter intuitiveness” of cyclic stick motion which could be considered a disturbance, since the pilot had to spend more time thinking about the direction he has to move the stick while following the commanded signal. The Figure 45 is a detail from the highest variance PFD roll comparison plot, which shows the behavior that gives more insight into this matter.

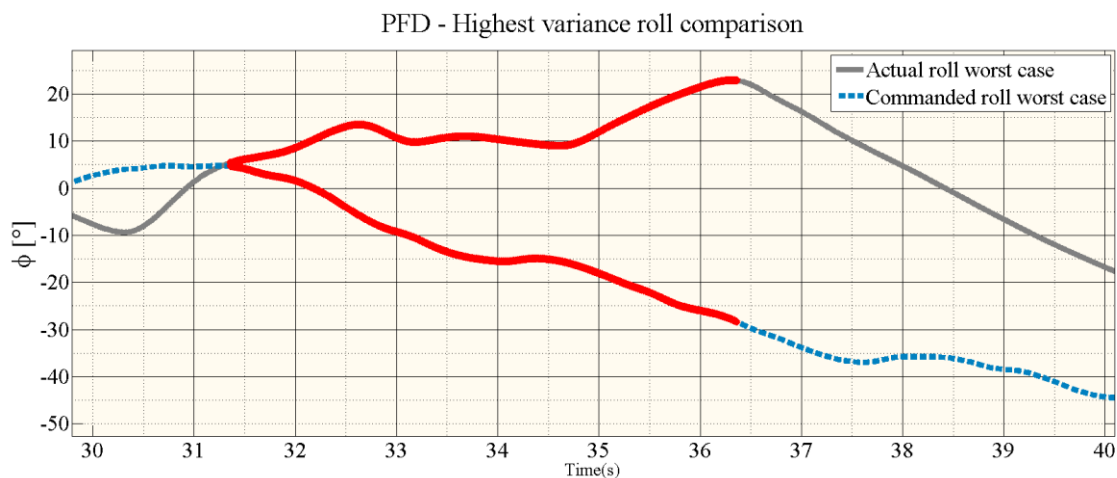

**Figure 45** A detail from the Task element roll PFD, red line stressing out the effect of counter intuitive lateral command

As explained previously in this section, the dashed blue line presents the commanded roll, and if the path is observed it can be concluded that the commanded roll signal starts at a positive value and as the time progresses, the value gets negative, indicating a negative roll angle, which should be a result of pilot's cyclic stick input to the left. The grey line, representing the actual roll value, should follow the commanded signal, which is not the case in this figure, since the actual roll tends to be in opposite way. To stress this scenario, a thick red line was plotted on the Figure 4. Finally, at the starting point where commanded and actual roll signal meet and the red line starts, it can be observed that the pilot has given an input in an opposite direction of which was commanded. Furthermore, while giving the pilot's stick input to the opposite direction of the commanded value, it took the pilot around 5 seconds to realize that fact, after which the pilot turned the cyclic stick in the correct direction, shown by the signal after the endpoint of red line. It is believed that this effect has a very strong impact on the flight naive pilots subjective workload assessment.

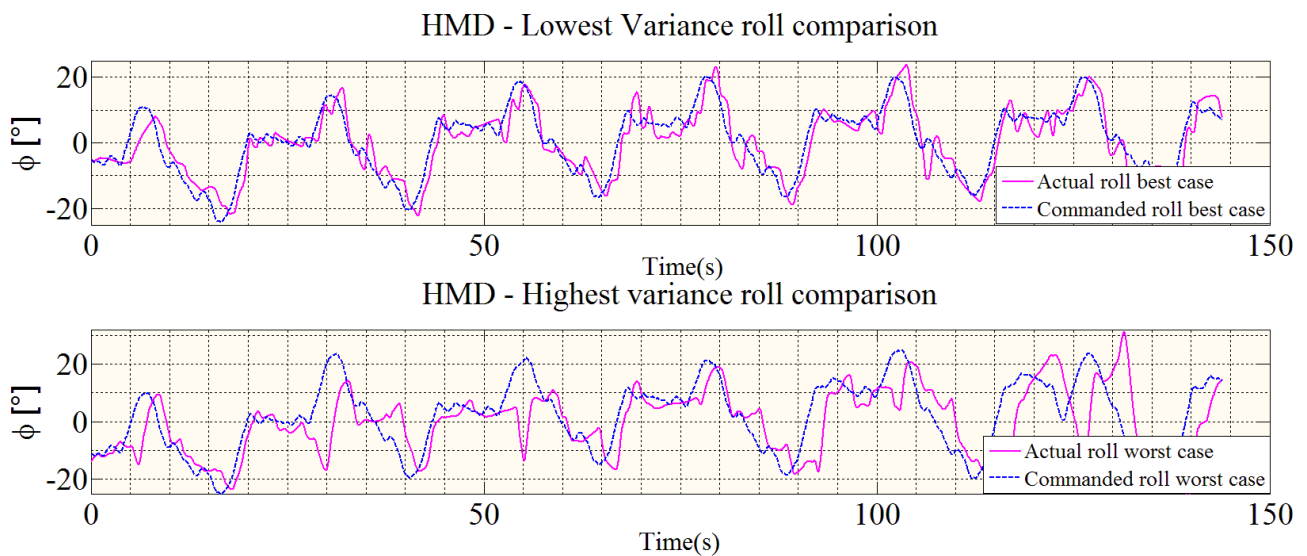

**Figure 46** Actual vs. commanded roll comparison of the recorded data for the lowest and highest error variance flight recordings using the PFD

When it comes to the landing part, it was not easy to find a valuable metric to conduct the objective analysis of the landing phase itself since the landing maneuver is a very challenging task. Task element landing was conducted separately from the previous task elements mentioned in the analysis section, since the simulator setup had to be somewhat changed. Namely, the switch in the cockpit which served for turning the guidance to the preset waypoint on and off had to be reprogrammed not to turn the guidance on once the switch was set to “on”. This way, it was possible to turn the switch on, once the flight naïve pilots were in the very near of the landing point, without turning the guidance on, and to turn it off once the landing was completed. By following this procedure, it was made possible to determine the exact time at which the switch was on in the flight recordings and to extract valuable cyclic stick activity recorded data during that period and to create the following plot.

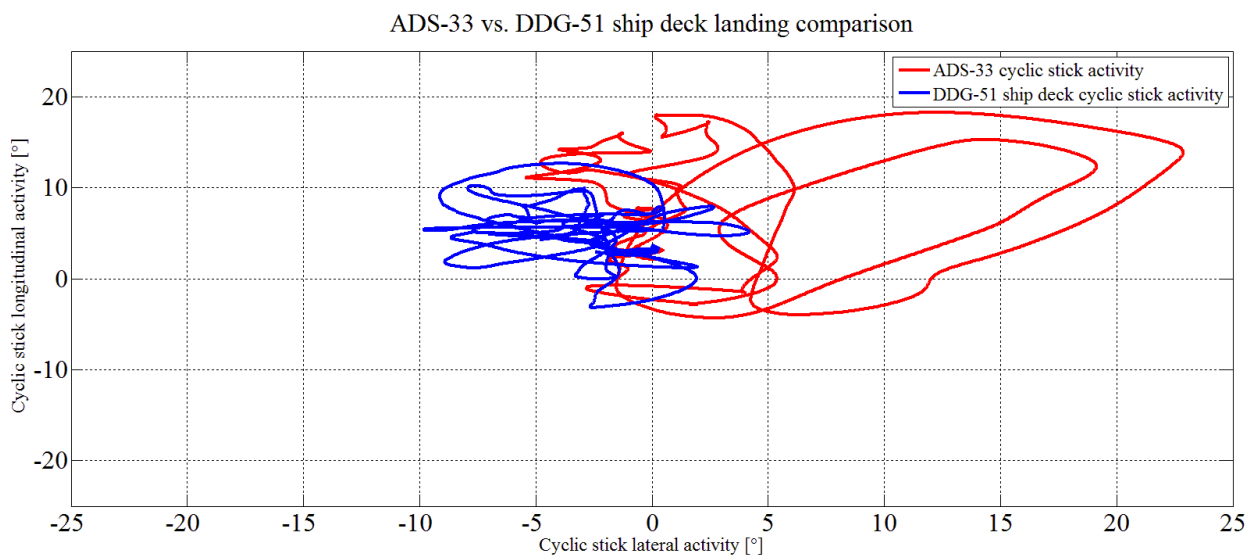

**Figure 47** Cyclic stick lateral and longitudinal activity recording for the landing scenarios of ADS-33 and ship deck landing

The plot contains recorded longitudinal and lateral stick input signals, as it was done in [23] for both ADS-33 and DDG-51 ship landing scenario where the ADS-33 cyclic stick activity plot is presented with red line, while the ship deck landing scenario is presented in blue. Already by taking a first look at the plot it is obvious that the cyclic stick input for the ADS-33 landing scenarios had a wider bandwidth of rotorcrafts cyclic stick activity compared to the ship deck

landing scenario. This was to be expected since the area of the ADS-33 landing spot is almost twice the size of the DDG-51 ship deck.

Furthermore, there were no physical obstacles like walls at the ADS-33 landing point, so the pilots had more freedom with the cyclic stick while approaching the landing point. That wasn't the case in the ship deck landing scenario since the ship deck area of the DDG-51 type ship is almost half the size of the ADS-33 platform. Furthermore, while approaching the ship deck from behind, in a straight-in approach, ship's hull structure connected with the landing deck, could have presented a psychological barrier for the flight naïve pilots, which is an explanation of narrower bandwidth of the cyclic stick input.

Nevertheless, it is interesting to observe the behavior of both recordings in general. Even though the ADS-33 cyclic stick activity has a wider bandwidth, when compared to the DDG-51 ship deck landing, it can be noted that the ship deck landing scenario recording shows more frequent change in the direction the cyclic stick was turned while landing. It can be concluded that the pilot in this scenario had to adjust the cyclic stick control input much more frequently than in the ADS-33 landing scenario. If the subjective workload assessment bar chart in Figure 39 regarding the landing task element are observed at this point once more, which has shown that the subjective workload assessment by the flight naïve pilots was higher for the ship deck landing task, the connection of the assessed workload and the cyclic stick activity during the landing process can be made. Even though the ship deck was static at the time the flight tests were conducted, the workload has proved to be very high for the landing task without any assistance for the flight test naïve pilots. An interesting discussion will arise once the flight tests including the ship deck in motion with data from the SCONE database will be included, and the flight tests are repeated.

## 6 CONCLUSION

The focus of this thesis was to examine the amount of workload the flight naïve pilots have to invest in several mission task elements regarding the helicopter ship deck landing procedure. To support the research, a realistic 3D model of the DDG-51 type destroyer class ship was implemented to the ROSIE simulator environment situated at the Lehrstuhl for Hubschrauber Technologie at the University of Munich. Furthermore, a full set of motion data recorded to the DDG-51 type ship derived from the SCONE database was implemented in ROSIE flightloop in Simulink and further adjustments have been made with MATLAB to support the future work and research enabling to set the ship in motion. Since this thesis presented the first step towards that goal, it was decided that the flight tests conducted for this Master's thesis will not include the ship in motion, so the 3D ship model located in lake Tegernsee in the simulator environment maintained a stationary position through the flight experiments.

Helicopter landing procedure was divided into three phases; navigation phase, descent phase and landing phase. For each landing phase, a specific mission task element was designed for the purposes of the flight trial experiments. A specific mission task element for the navigation phase was designed which included the commanded value for the roll angle the flight naïve pilots were supposed to follow to ensure swift approach to the predetermined waypoint while being assisted by the rotorcraft since the flight naïve pilots had to input only the roll command during the flight via cyclic stick. The roll commanded value was displayed to the pilots in two instruments separately, in the first mission task element via PFD, followed by the same mission scenario with the commanded roll angle value displayed in the HMD. Regarding the landing maneuver itself, a specific mission task element was designed in which the pilots were asked to land on the ADS-33 training landing platform, followed by landing on the steady DDG-51 ship landing deck. Specific set of questionnaires was designed to investigate the amount of workload in every mission task element with adjusted Bedford Rating Scale to obtain subjective assessment of the workload, followed by the Simulator Sickness Questionnaire and two more custom made questionnaires with purpose of clarifying the main factors influencing the assessed workload in the mission task elements. Furthermore, an objective analysis was conducted, analyzing the flight naïve pilot's cyclic stick input signals in the last phase of landing procedure to find a connection between the recorded cyclic stick input data and subjective workload assessment provided by the pilots.



Since the landing procedure is considered to be one of the most demanding missions for the helicopter pilots in general, it was expected that the amount of workload derived from the questionnaires will be high, which was confirmed once the questionnaire data had been analyzed. Furthermore, an interesting fact arises from the analysis, stating that the flight naïve pilots who volunteered the experiments found the HMD as a preferred instrument on which the flight parameters were displayed over the PFD option. Nevertheless, even though the flight naïve pilots preferred the HMD over PFD and generally assessed the workload to be lower in mission task elements in which they were using HMD, objective analysis has shown that the mean error between the commanded roll value and actual input roll value the pilots were commanding while trying to follow the commanded value was generally lower using the PFD. Furthermore, when it comes to the landing itself, the flight naïve pilots found the ship deck landing to be more demanding in terms of workload which was an expected assessment since the DDG-51 ship deck is almost half of the size in area compared to the ADS-33 training platform. After analyzing the cyclic stick input motion in this final maneuver, it was observed that the cyclic stick activity in the ship deck landing case scenario was higher than in the ADS-33 training landing platform scenario which confirms the subjective workload assessment.

Results from this work will be used to support more HELIOP projects in the future and are found to be useful particularly in terms of improvement of ADI in PFD and HMD and in future Urban Air Mobility research. Furthermore, the subjective workload assessment from the flight naïve pilots will be interesting in the projects to come where the professional helicopter pilots will be invited for the flight tests including the DDG-51 ship in motion enabled by the SCONE database implementation to the ROSIE flight loop.

## 7 LITERATURE

- [1] Dooyong Lee, Joseph Horn, Nilay Sezer-Uzol, and Lyle Long. "Simulation of Pilot Control Activity During Helicopter Shipboard Operations", AIAA Atmospheric Flight Mechanics Conference and Exhibit, Guidance, Navigation, and Control and Co-located Conferences, 2003
- [2] Haagenen, Rolf; Sjøborg, Karl-Åke; Rossing, Anders; Ingilæ, Henry; Markengbakken, Lars; Steen, Peter-Andreas: Long-Range Rescue Helicopter Missions in the Arctic. In *Prehosp. Disaster med.* 19 (02), pp. 158–163., 2004.
- [3] <https://www.marineinsight.com/marine-safety/10-important-points-helicopter-operations-onboard-ships/>, 17.04.2019.
- [4] <https://www.upi.com/Defense-News/2014/07/28/Army-helo-crews-conduct-landing-on-Navy-ship/6491406563368/>, 17.04.2019.
- [5] PĂDURARIU, Dinu; CREȚU, Nicolae: HELICOPTERS DURING MARITIME MISSIONS. In *AFASES 2017* 19 (1), pp. 145–152., 2017.
- [6] <https://www.ht.mw.tum.de/index.php?id=163>, 17.04.2019.
- [7] SCONE - Standard Deck Motion Data for a Generic Surface Combatant
- [8] Santoso, Mochamad Yusuf; Su, Shun-Feng; Aisjah, Aulia Siti: Nonlinear rudder roll stabilization using Fuzzy Gain Scheduling - PID controller for naval vessel. In : 2013 International Conference on Fuzzy Theory and Its Applications (iFuzzy). 6-8 Dec. 2013, Taipei, Taiwan. 2013 International Conference on Fuzzy Theory and Its Applications (iFUZZY). Taipei, Taiwan, 6/12/2013 - 8/12/2013. International Conference on Fuzzy Theory and Its Applications; iFuzzy. Piscataway, NJ: IEEE, pp. 94–99., 2013.
- [9] C. Hagerty, James & D. Stevens, Pauleen & T. Wolfe, Bryan. DDG 1000 vs. DDG 51: An Analysis of U.S. Navy Destroyer Procurement. 55., 2008.
- [10] Joseph Francis Horn, Junfeng Yang, Chengjian He, Dooyong Lee, John K. Tritschler: 41st European Rotorcraft Forum. 1-4 September 2015: Munich, Germany. Red Hook, New York, Bonn, Germany: Curran Associates; Deutsche Gesellschaft fuer Luft und Raumfahrt., 2015.
- [11] Zhao, D., Krishnamurthi, J. Mishra, S., and Gandhi, F., "Differential Flatness Based Trajectory Generation for Time-Optimal Helicopter Shipboard Landing ", Proceedings of the 2018 American Control Conference, Milwaukee, Wisconsin, June 27–29, 2018.
- [12] <https://news.usni.org/2016/10/18/southcom-pitching-new-low-cost-ideas-get-ships-operating-u-s-4th-fleet>, 17.04.2019.
- [13] Omkar Halbe, Christian Spieß, and Manfred Hajek. "Rotorcraft Guidance Laws and Flight Control Design for Automatic Tracking of Constrained Trajectories.", 2018 AIAA Guidance, Navigation, and Control Conference, AIAA SciTech Forum, (AIAA 2018-1343), 2018.

- [14] Perfect, P., Jump, M., White, M.D. Methods to Assess the Handling Qualities Requirements for Personal Aerial Vehicles. *Journal of Guidance, Control and Dynamics*, Vol. 38, No.11, pp. 2161-2172., 2015.
- [15] Vrdoljak M., "Simulator experiments for helicopter pilot model in roll tracking task", TUM internal report, 2017.
- [16] MPP-02(H)(1), Volume I, HELICOPTER OPERATIONS FROM SHIPS OTHER THAN AIRCRAFT CARRIERS (HOSTAC), 2017.
- [17] Efremov, A.V, Ogloblin, A.V., Predtechenskii, A.N., and Rodchenko, V.V., *Letchik kak dinamicheskaya sistema* (Pilot as a Dynamic System), Moscow: Mashinostroenie, 1992.
- [18] A. V. Efremov and et al. Analysis of reasons for pilot induced oscillation tendency and development of criteria for its prediction. in: Investigation of pilot induced oscillation tendency and prediction criteria development. Tech. Report WL-TR-96-3109, Flight dynamics directorate, Wright Laboratory, Air Force Materiel Command, Wright-Patterson AFB, 1996.
- [19] F. Schuck. Ein integriertes Auslegungskonzept zur Sicherstellung exzellenter Handling Qualities für Kleinflugzeuge. PhD thesis, München, Technische Universität München, Diss., 2014.
- [20] H. Roscoe, A & A. Ellis, G. A Subjective Rating Scale for Assessing Pilot Workload in Flight: A decade of Practical Use. 18., 1990.
- [21] Joshi, Ankur & Kale, Saket & Chandel, Satish & Pal, Dinesh. Likert Scale: Explored and Explained. *British Journal of Applied Science & Technology.*, 2015.
- [22] Kennedy, R.S., Lane, N.E., Berbaum, K.S., & Lilienthal, M.G. Simulator Sickness Questionnaire: An enhanced method for quantifying simulator sickness. *International Journal of Aviation Psychology*, 1993.
- [23] Scott, Paul & Kelly, Michael & White, Mark & Owen, Ieuan. USING PILOTED SIMULATION TO MEASURE PILOT WORKLOAD OF LANDING A HELICOPTER ON A SMALL SHIP., 2017.