

# Utvrđivanje sastava te primjena optimalnih metoda analize uzorka

---

Stančin, Hrvoje

Master's thesis / Diplomski rad

2018

*Degree Grantor / Ustanova koja je dodijelila akademski / stručni stupanj:* **University of Zagreb, Faculty of Mechanical Engineering and Naval Architecture / Sveučilište u Zagrebu, Fakultet strojarstva i brodogradnje**

*Permanent link / Trajna poveznica:* <https://urn.nsk.hr/urn:nbn:hr:235:005297>

*Rights / Prava:* [In copyright](#)/[Zaštićeno autorskim pravom.](#)

*Download date / Datum preuzimanja:* **2025-03-04**

*Repository / Repozitorij:*

[Repository of Faculty of Mechanical Engineering and Naval Architecture University of Zagreb](#)



UNIVERSITY OF ZAGREB  
Faculty of Mechanical Engineering and Naval Architecture

# **MASTER'S THESIS**

**Hrvoje Stančin**

Zagreb, 2018.

UNIVERSITY OF ZAGREB  
Faculty of Mechanical Engineering and Naval Architecture

# **Samples property identification and study methodology of samples analysis**

Supervisors:

Prof. dr. sc. Neven Duić  
Prof. Dagmar Juchelkova, Ph.D.

Student:

Hrvoje Stančin

Zagreb, 2018.

I hereby declare that this thesis is entirely the result of my own work except where otherwise indicated. I have fully cited all used sources and I have only used the ones given in the list of references.

I would like to express my sincere gratitude to both of my supervisors, Prof. Duić and Prof. Juchelkova, who arranged this collaboration between our institutions and made this work possible.

Furthermore, I am truly thankful to Dr. Hrvoje Mikulčić, whose suggestions, comments and help made this work possible. He significantly contributed to successful completion of this thesis.

I would also like to express my gratitude to Prof. Helena Raclavska, Prof. Jana Ružičkova, Prof. Konstantin Raclavsky and all other academic staff from Vysoka Škola Banská- Technická Univerzita Ostrava with whom I worked on this thesis.

Also, big thank you goes to all my friends and colleagues for all the support and encouragement I received during the work on this thesis.

Finally, I would like to thank to my family, especially my sister Erina, for all support and help I received during my studies.

Thank you all,

Hrvoje Stančin



SVEUČILIŠTE U ZAGREBU  
**FAKULTET STROJARSTVA I BRODOGRADNJE**



Središnje povjerenstvo za završne i diplomske ispite  
Povjerenstvo za diplomske ispite studija strojarstva za smjerove:  
procesno-energetski, konstrukcijski, brodostrojarški i inženjersko modeliranje i računalne simulacije

Sveučilište u Zagrebu	
Fakultet strojarstva i brodogradnje	
Datum	Prilog
Klasa:	
Ur. broj:	

## DIPLOMSKI ZADATAK

Student: **Hrvoje Stančin** Mat. Br.: 0035192938

Naslov rada na hrvatskom jeziku: **Utvrđivanje sastava te primjena optimalnih metoda analize uzorka**

Naslov rada na engleskom jeziku: **Samples property identification and study methodology of samples analysis**

Opis zadatka:

In order to determine composition of some material, particular laboratory investigations or experiment needs to be performed on the sample. Material science provides us with numerous possible techniques which could be performed, depending on the nature of the sample. For this study waste rigid polyurethane foam will be used as sample. The aim of this work is to perform suitable experiments, collect the results, perform the result analysis, and develop the corresponding conclusion. The study objective is to determine whether waste rigid polyurethane foam material can be used for waste-to-energy applications.

The candidate shall perform the following tasks within this master thesis:

1. Describe the nature of the sample, applications and motive for its investigation. Provide a literature overview of the previous related investigations.
2. Determine the composition of the sample using one of the investigation techniques.
3. Perform experiment on the sample, using suitable investigation techniques. Collect the results and analyze them.
4. Develop the conclusion according to the study objective.

The thesis should include the list of used literature and state if any assistance was received.

Zadatak zadan:  
18. siječnja 2018.

Datum predaje rada:  
22. ožujka 2018.

Predviđeni datum obrane:  
28., 29. i 30. ožujka 2018.

Zadatak zadao:  
Prof. Dagmar Juchelkova, Ph.D.

Prof.dr.sc. Neven Duić

Predsjednica Povjerenstva:

Prof. dr.-sc. Tanja Jurčević Lulić

## **Table of Contents**

List of Figures.....	III
List of Tables.....	IV
Abstract.....	V
Sažetak (Abstract in Croatian).....	VI
Prošireni sažetak (Extended abstract in Croatian).....	VIII
Pregled korištenih metoda analize uzorka.....	VIII
Analiza uzorka.....	XI
1. Introduction.....	1
1.1. Polyurethanes.....	2
1.2. Polyurethane foams (PUFs).....	3
1.3. Polyurethane recycling process.....	5
1.4. Previous investigations related to thermal degradation of rigid polyurethane foams.....	6
2. Material and Methods.....	9
2.1. X-ray Fluorescence Analysis (XRF Analysis).....	9
2.1.1. Fundamentals of XRF spectrometry.....	10
2.1.2. Operating conditions.....	11
2.1.3. Instrumentation.....	13
2.2. Thermal analysis.....	14
2.2.1. Classification of methods.....	14
2.2.2. General specifications of the instrument.....	16
2.2.3. Characterization, interpretation and presentation of results.....	17
2.3. Thermogravimetry (TG).....	18
2.3.1. Fundamentals of Thermogravimetric analysis and kinetic mechanism.....	19
2.3.2. Thermobalance instrument.....	21
2.3.3. Temperature control.....	22

2.3.4.	Atmosphere control.....	26
2.3.5.	Sample considerations.....	27
2.3.6.	Sources of the error and instrument calibration .....	28
2.3.7.	Characterization, interpretation and presentation of results.....	29
2.4.	Gas chromatography-Mass spectrometry (GC-MS).....	32
2.4.1.	Gas chromatography .....	33
2.4.2.	Mass spectrometry .....	35
2.4.3.	Results acquisition and presentation.....	38
3.	Sample preparation and identification.....	40
3.1.	XRF spectrometry of WRPUF .....	40
3.2.	Particle sizing .....	42
3.3.	Sample homogenization and thermal analysis .....	43
4.	Results and discussion.....	46
4.1.	Decomposition mechanism in oxidative and non-oxidative atmosphere.....	46
4.2.	Non-homogenous mixture.....	48
4.3.	Homogenized sample.....	55
4.3.1.	Homogenized samples- results overview.....	60
4.4.	Fraction analysis .....	63
5.	Conclusion .....	69
	Bibliography .....	71

## List of Figures

Figure 1-Formation of PU foam from the reaction between isocyanates and water [3].....	3
Figure 2- Thermal conductivity values of various insulation materials [3] .....	4
Figure 3- Bohr's atomic mode, shell model.....	10
Figure 4- Illustration of XRF spectrometry [5] .....	12
Figure 5- Example of an XRF spectrum [30].....	13
Figure 6- Devices to determine TG curve and DTA curve [7].....	15
Figure 7- Examples of the measured curves [7] .....	18
Figure 8- Possible types of mass loss [31] .....	21
Figure 9- Schematic representation of TGA arrangements [31] .....	21
Figure 10- Possible arrangement of a focus for radiative heating [7].....	23
Figure 11- Possible arrangements of the thermocouples [7].....	24
Figure 12- Basic concept of CRTA [7] .....	25
Figure 13- Vertical and horizontal arrangement of thermobalance device [8] .....	28
Figure 14- Example of TG and DTG curves for some polymer material [31].....	30
Figure 15- Schematic view of the coupled GC-MS instrumentation [9] .....	33
Figure 16- Gas chromatograph [36].....	34
Figure 17- Schematic view of mass spectrometer [38].....	37
Figure 18- Example of the Total ion current (TIC) curve [39] .....	39
Figure 19- Distribution of particle size .....	42
Figure 20- Detailed view on particle size distribution.....	43
Figure 21- TG curve in Air atmosphere-initial mass 10 mg .....	46
Figure 22- TG curve in Air atmosphere- initial mass 24 mg .....	47
Figure 23- TG curve in Nitrogen atmosphere- initial mass 10 mg.....	48
Figure 24- Yield of PAHs .....	52
Figure 25- Yield of gaseous products .....	55
Figure 26- Comparison of Compounds containing chlorine .....	61
Figure 27- Yield and composition of gaseous products from designed mixture.....	62
Figure 28- Yield of organic compounds from different fractions .....	64
Figure 29-Detected organic compounds in analyzed fractions .....	65
Figure 30- Gaseous products from different fractions at 600 °C.....	68



**List of Tables**

Table 1- Primary classification of Thermal analysis methods [7] .....	15
Table 2- Methods of data acquisition [7] .....	31
Table 3- Ultimate and proximate analysis of WRUF .....	40
Table 4- Results of XRF spectrometry.....	41
Table 5- Division on a fraction.....	44
Table 6- Organic compounds groups founded in non-homogenized sample.....	49
Table 7- Concentration of various organic compounds .....	50
Table 8- Compounds containing Chlorine .....	53
Table 9- Compounds which are classified as carcinogen or potentially carcinogen.....	54
Table 10- Identified organic compounds of fraction with particles above 0.25 mm.....	57
Table 11- Identified organic compounds of fraction with particles below 0.25 mm.....	58
Table 12- Identified organic compounds of mixture with particles above and below 0.25 mm .....	59
Table 13- Concentrations of detected groups .....	66
Table 14- Composition of gaseous products for analyzed fractions.....	68

## **Abstract**

The thesis presents several investigations techniques related to the examination of sample's chemical composition and thermal decomposition behavior. Investigated sample was waste rigid polyurethane foam (WRPUF) which was used as an insulation material in a refrigerator. The aim of the thesis was to investigate yield of organic compounds and gaseous products from the selected sample and determine whether it can be used for waste-to-energy application. Sample was conducted to several investigations: XRF spectroscopy, particle sizing and analytical pyrolysis coupled with gas chromatography-mass spectrometry (Py/GC-MS). Sample was obtained in grinded powder with non-homogenous structure. Sample preparation consists of fractionations and homogenization procedure. Analysis was carried out on three pyrolysis temperatures 500, 600 and 700 °C. Investigation was performed on non-homogenous mixture, fraction with particle size below 0.25 mm, fraction with particle size above 0.25 mm and homogenized mixture with particles below and above 0.25 mm. Additional analyses was carried out for eight different fractions to determine grain size effect on yield of decomposition products.

Obtained results show that homogenization of sample had a huge impact on the yield and composition of organic compounds. Dominant group in every investigation remained compounds containing nitrogen (amines and amides), while considerable share of aromatic hydrocarbons, alcohols, alkanes and alkanoates were detected as well. Around 18 different groups and more than 200 organic compounds were detected, with different share and presence in examined mixtures. During the analysis, special attention was given to the compounds which may be hazardous or harmful to human health. Compounds which are classified as dangerous and were detected during analysis are compounds containing chlorine, polycyclic aromatic hydrocarbons (PAHs), furans, phthalates, benzene based compounds, etc. Analysis of evolved gaseous products showed that dominant emissions in every investigation were carbon dioxide and nitrogen emissions (CO<sub>2</sub>, -NO<sub>x</sub>). Significant emission share was detected for ammonia (NH<sub>3</sub>) and trichlorofluoromethane (CFC-11). Several others, mostly harmless, gaseous products were detected as well.

Additionally, results were compared to similar previous investigations and regulatory framework for refuse derived-fuel (RDF). Finally, adequate conclusion according to study objective was carried out together with perspective for further investigations.

Key words: WRPUF, pyrolysis, gas chromatography, mass spectrometry, RDF, XRF-spectroscopy

## Sažetak (Abstract in Croatian)

U ovom radu navedeno je nekoliko eksperimentalnih metoda koje se koriste za ispitivanje kemijskog sastava uzorka i analizu njegove termalne dekompozicije. Analiza je provedena na iskorištenoj otpadnoj krutoj poliuretanskoj pjeni (engl. waste rigid polyurethane foam - WRPUF), koja je bila korištena kao izolacijski materijal u hladnjaku. Analiza ovog uzorka trebala je otkriti produkte njegove degradacije, u prvom redu organski sastav i oslobođene emisije plinova, te mogućnosti iskorištavanja ovog materijala u energetskej uporabi.

Uzorak je podvrgnut različitim eksperimentalnim metodama kao što su: XRF spektroskopija, mjerenje veličina čestica te analitičkoj pirolizi uparenoj sa plinskom kromatografijom i masenom spektrometrijom (Py/GC-MS). Uzorak je dobiven u formi mljevenog praha sa nehomogenom kompozicijom. Priprema uzorka za ispitivanje podrazumijevala je njegovu podijelu na više manjih homogenih frakcija te kreiranje homogenih struktura za ispitivanje. Analiza se sastojala od ispitivanja organskog sastava na 500, 600 i 700 °C. Uzorak je podvrgnut analizi u nehomogenoj kompoziciji, kompoziciji sa veličinom čestica iznad 0,25 mm, kompoziciji sa veličinom čestica ispod 0,25 mm te dizajniranoj homogenoj smjesi sa kombinacijom čestica iznad i ispod 0,25 mm. Dodatna analiza provedena je i na osam homogenih frakcija, kako bi se istražio utjecaj veličine čestica na produkte degradacije.

Dobiveni rezultati pokazuju kako je homogenizacija uzroka imala veliki utjecaj na formiranje organskih produkata tijekom degradacije. Dominantna organska grupa u svim istraživanjima bili su spojevi sa dušikom (amini i amidi). Značajne koncentracije zabilježene su i kod aromatskih ugljikovodika, alkohola, alkana te alkanoata. Ukupno je identificirano 18 različitih skupina organskih spojeva te preko 200 različitih organskih produkata. Njihova prisutnost i udio variraju ovisno o ispitivanoj kompoziciji. Tijekom analize rezultata, posebna je pozornost pridana opasnim i rizičnim kemijskim komponentama, koje predstavljaju prijetnju okolišu i ljudskom zdravlju. Identificirane opasne komponente su: spojevi sa klorom, policiklički aromatski ugljikovodici, furani, ftalati i spojevi sa benzenom. Navedene komponente predstavljaju opasnost za rad energetskih postrojenja, a velik broj posjeduje i kancerogena svojstva. Analiza plinskih produkata prikazuje dominantan udio emisija ugljikova dioksida te raznih dušičnih oksida ( $\text{CO}_2$ ,  $\text{NO}_x$ ). Također, zabilježen je i značajan udio emisija amonijaka ( $\text{NH}_3$ ) te izrazito štetnog freona, triklorofluorometana (CFC-11). Plinska mješavina produkata sastoji se također i od, uglavnom bezopasnih, cikloalakana i alakana.

Na kraju, dobiveni rezultati uspoređeni su sa poznatim sličnim istraživanjima te zakonsko-regulativnim direktivama za proizvodnju goriva iz otpada (engl. refuse derived-fuel - RDF). Na temelju tih usporedbi, izvedeni su zaključci sukladni svrsi rada te perspektive i mogućnosti daljnih istraživanja ispitivanog uzorka.

Ključne riječi: WRPUF, piroliza, plinska kromatografija, masena spektrometrija, RDF, energetska uporaba, XRF-spektroskopija

## **Prošireni sažetak (Extended abstract in Croatian)**

U sklopu ovog rada provedene su razne laboratorijske metode ispitivanja sastava iskorištene orpadne krute poliuretanske pjene (engl. waste rigid polyurethane foam - WRPUF). Cilj ovog rada bio je detektirati kemijski sastav ispitivanog uzorka, odrediti mehanizam njegove termalne degradacije te procijeniti potencijal njegove energetske uporabe.

Polimerni materijali jedni su od najvažnijih materijala u našoj svakodnevici. Njihova prisutnost i upotreba može se pronaći u raznim industrijama. Upravo zbog te širine upotrebe, kemijska svojstva polimernih materijala mogu značajno varirati. Polimerni materijalni danas, najčešće su umjetno sintetizirani iz fosilnih goriva, što znači da su bogati ugljikovodicima. Prilikom proizvodnje polimernih materijala, dodaju se razni aditivi kako bi se poboljšala svojstva samog materijala te se tako u kemijskom sastavu polimera često mogu pronaći elementi sumpora, klora, dušika itd. Polimeri su reciklabilni materijalni, ali prilikom svakog ciklusa reciklaže, njihova vrijednost i mogućnost ponovne upotrebe opada. Kada se materijal više ne može reciklirati, nastaje veliki problem njegova odlaganja. Prema Direktivi Europske Komisije [1], na odlagališta otpada može se jedino deponirati inertni otpad čiji je potencijal u potpunosti iskorišten. Kako polimerni materijali imaju veliki udio ugljikovodika u svojem sastavu, posjeduju veliku ogrjevnu moć te su kao takvi izrazito podobni za energetske uporabu. Međutim, kako bi se za svaki materijal odredila njegova odgovarajuća upotreba, potrebno je provesti detaljnu analizu njegova sastava te ponašanja na zahtijevanim uvjetima.

Poliuretanska pjena [2] ima veliki volumen te kao takva predstavlja veliki problem prilikom zbrinjavanja otpada [3]. Upravo iz tog razloga, energetska uporaba može biti dobro rješenje takvog problema. Osim što energetska uporaba bitno smanjuje volumen otpada, vrlo je efikasna za suzbijanje patogenih organizama, ali i pruža mogućnost smanjenja emisija stakleničkih plinova [4].

### **Pregled korištenih metoda analize uzorka**

Za potrebe analize uzorka korišteno je nekoliko različitih metoda. Uzorak je prvo podvrgnut XRF-spektroskopiji i mjerenju veličine čestica, kako bi se odredio njegov stupanj homogenosti te kako bi se detektirala prisutnost različitih kemijskih elemenata u njegovom sastavu. Nakon prethodno navedenih analiza, pristupilo se toplinskoj analizi uzorka kako bi se odredio organski sastav i plinski produkti njegove termalne dekompozicije, ali i sam

mehanizam, odnosno kinetika tog postupka. Korištena metoda toplinske analize bile je piroliza uparena sa plinskom kromatografijom te masenom spektrometrijom (Py/GC-MS).

XRF-spektroskopija, nerazorna je metoda određivanja elementarnog sastava uzorka. Metoda počiva na fotoelektričnom efektu u kojem se emitirano zračenje apsorbira i prenosi na unutrašnje elektrone. Emitirano zračenje mora biti veće od energije ionizacije kako bi se elektron uspješno izbacio iz svoje orbitale. Upraznjeno mjesto u orbitali popunjava se elektronima iz viših orbitala. Prilikom prijalaza u niže orbitale elektroni emitiraju x-zračenje koje je jednako razlici energija između pobuđenog i osnovnog nivoa. S obzirom da svaki element ima jedinstven set energetske nivoa, x-zrake su karakteristične za svaki element te se temeljem toga određuje elementarni sastav ispitivanog uzorka [5]. Slika 1 prikazuje ilustraciju funkcioniranja metode.

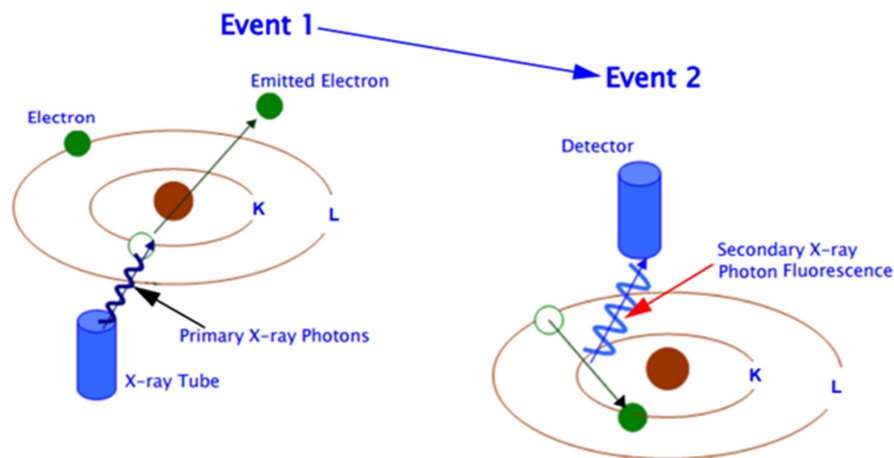

Slika 1- Shematski prikaz XRF-spektroskopije

Mjerenje veličina čestica koristi se kako bi se odredila homogenost uzorka. Čestice prolaze kroz fokusirani laserski snop te raspršuju emitiranu svjetlost lasera. Svjetlost se raspršuje prema određenim kutovima koji su inverzno proporcionalni njihovoj veličini. Raspršena svjetlost zatim se mjeri i detektira raznim fotosenzorima, a rezultati se prikazuju u obliku distribucijske krivulje veličine čestica [6].

Toplinska analiza je zajednički naziv za niz raznih tehnika koje se koriste za ispitivanje određenih svojstava materijala. Sve toplinske tehnike podrazumijevaju mjerenje promjene određenog svojstva uzorka prilikom promjene temperature. Jedna od najpopularnijih tehnika, koja je korištena i u ovom radu, zove se Termogravimetrijska analiza (TGA). Fokus ove tehnike jest promjena mase uzorka prilikom njegove izloženosti povišenoj

temperaturi. Uređaji koji se koriste u ovoj metodi moraju imati mogućnost simultanog mjerenja promjene mase, ali i temperature. Rezultati se prikazuju u obliku termogravimetrijske krivulje, a služe za određivanje kinetičkog mehanizma degradacije materijala. Osim samog uzorka, odnosno njegove pripreme, veliki utjecaj na rezultat ispitivanja ima i atmosfera u kojoj se uzorak nalazi prilikom ispitivanja. Atmosfera je generirana pomoću plinova koji protječu kroz ispitivano područje, a pritom i odnose sa sobom oslobođene plinske produkte termalne dekompozicije materijala. Plinovi koji se koriste mogu biti inertni plinovi kao što su dušik, helij, argon, ali mogu se koristiti i kisik ili zrak. Nadalje, za uspješno provođenje eksperimenta posebnu pažnju treba posvetiti izvoru topline, pozicioniranju termoparova koji se koriste za mjerenje temperature, kontroli protoka plinova te odabiru veličine ispitivanog uzorka. S obzirom na veliki broj parametara koji utječu na proces, mogućnost pogreške relativno je velika. Određene pogreške uspješno se rješavaju pravilnom kalibracijom uređaja, dok se ostale pogreške mogu izbjeći pravilnim rukovanjem od strane laboratorijskog operatera. Kako bi rezultati analize bili potpuni, toplinske tehnike najčešće se koriste simultano sa određenim kromatografskim i spektrometrijskim metodama [7].

Plinska kromatografija i masena spektrometrija koriste se zajedno za identificiranje i kvantificiranje produkata termalne degradacije uzorka. Plinska kromatografija koristi se za razdvajanje plinskih smjesa hlapljivih organskih spojeva. Razdvajanje smjesa postiže se pomoću stacionarne i mobilne faze u snopu cijevi kroz koju se provodi plinska smjesa. Temljem afiniteta prema stacionarnoj fazi, plinovi se razdvajaju te odlaze na detektor sa određenim vremenskim razmakom. Takvo razdvajanje smjese, omogućuje detektorima da pravilno identificiraju, ali i kvantificiraju oslobođene organske spojeve. Masena spektrometrija koristi električni naboj i masu za identifikaciju molekula. Preduvjet za uspješnu analizu jest ionizacija molekula. Postoji više vrsta ionizacije, ovisno o tipu uređaja, ali i o željenoj razini fragmentacije molekula. Elektronska ionizacija koja je korištena u ovom radu, koristi snop elektrona kojim se bombardiraju molekule u plinskoj fazi. Nakon uspješne ionizacije, nastali ioni provode se u analizator gdje se razdvajaju na temelju omjera mase i električnog naboja. Nakon uspješnog razdvajanja, ioni odlaze do detektora gdje proizvode karakteristični električni signal temeljem kojeg se vrši njihova identifikacija i kvantifikacija [8]. Na Slici 2 nalazi se shematski prikaz aparature koje se koristi za ovaj postupak.

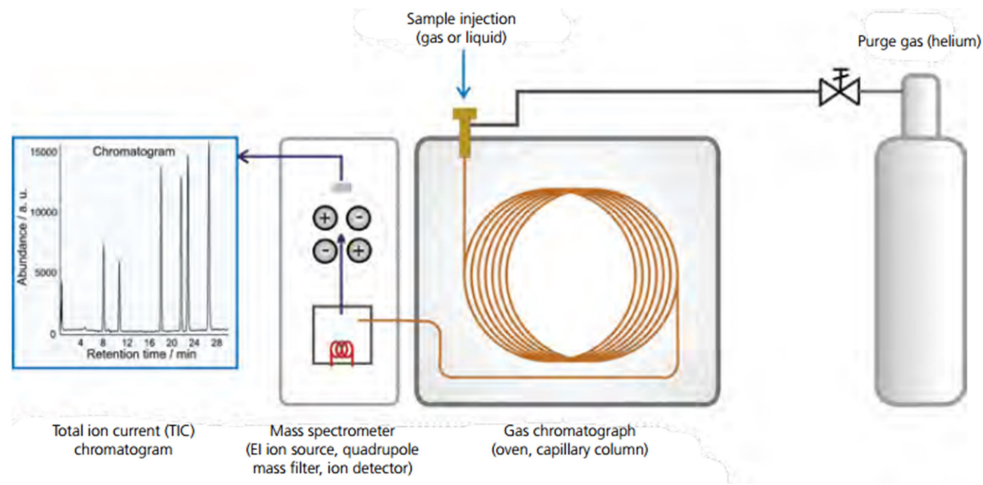

**Slika 2- Shematski prikaz plinske kromatografije-masene spektrometrije [9]**

### **Analiza uzorka**

Uzorak je pribavljen u formi mljevenog praha sa poznatim rezultatima ultimativne i proksimativne analize (Tablica 1). Kao što je i bilo očekivano, kod uzorka su zabilježeni veliki udjeli ugljika i hlapljivih tvari. Također, prisutan je i određni udio vodika i dušika, dok je sumpor prisutan u tragovima. Iako ogrjevna vrijednost nije određena ovom analizom, na temelju prikazanih udjela može se očekivati da uzorak posjeduje značajnu ogrjevnju moć i potencijal.

**Tablica 1- Ultimativna i proksimativna analiza poliuretanske pjene**

Sample	Ultimate analysis (wt. %)					Proximate analysis (wt. %)		
	C <sub>ad</sub>	H <sub>ad</sub>	O <sub>ad</sub>	N <sub>ad</sub>	S <sub>ad</sub>	V <sub>ad</sub>	FC <sub>ad</sub>	A <sub>ad</sub>
Polyurethane	62.69	6.32	24.01	6.37	0.63	83.2	10.6	6.2

Prvo se pristupilo određivanju stupnja homogenosti uzroka. U tu svrhu provedena je analiza mjerenja veličine čestica uzorka pomoću uređaja Malvern Mastersizer 2000. Rezultati ove analize prikazani su na Slici 3. Vidljivo je da se u distribucijskoj krivulji nalaze dva vrha, što ukazuje na nehomogenost uzroka.



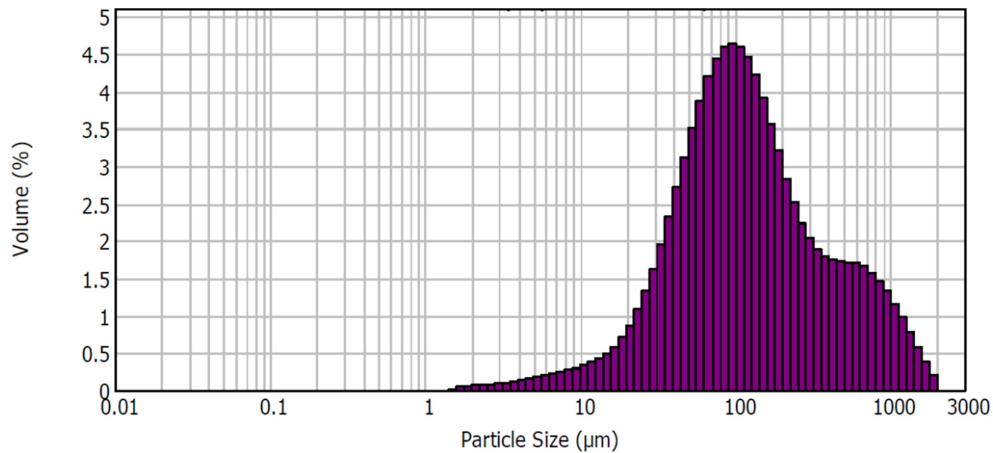

**Slika 3- Rezultati mjerenja veličine čestica**

Kako bi se odredio točan elementaran sastav poliuretanske pjene, pristupilo se XRF-spektroskopiji. Ultimativnom analizom, utvrđen je točan udio ugljika, vodika, dušika i sumpora. Udio kisika određen je razlikom ukupne koncentracije i sume prethodno navedenih elemenata. Važno je napomenuti da XRF-spektroskopija ima mogućnost detekcije elemenata čiji je protonski broj veći od 11 ( $Z > 11$ ) [10]. Rezultati ove istrage prikazani su u Tablici 2. Uzorak je sijanjem podijeljen u tri frakcije: frakcija sa veličinom česticama iznad 2 mm, frakcija sa veličinom česticama ispod 2 mm smjesa sa česticama iznad i ispod 2 mm. Iz rezultata je vidljivo da veliki dio elemenata nije identificiran (LE), što je i očekivano s obzirom da ugljik, vodik, sumpor i dušik imaju protonski broj manji od 11, a iz Tablice 1 vidljivi su njihovi udjeli. Najveći udio zabilježen je za klor (Cl) te varira između 3,68% do čak 4%. Povećana koncentracija klora je očekivana s obzirom na njegovu upotrebu kao aditiva prilikom proizvodnje, no ovoliki udio daleko je iznad dopuštenih tehničkih i regulatornih limita [11]. Elementi kao što su olovo i živa, a čija pristunost nije poželjna, detektirani su u malim i dopuštenim koncentracijama. Dopuštena koncentracija olova (Pb) iznosi 200 ppm [11], a u ovom slučaju najveća izmjerena vrijednost jest 175 ppm. S druge strane, prisutnost žive (Hg) nije uopće detektirana.

**Tablica 2- Rezultati XRF-spektroskopije**

Mješavina		Frakcija sa česticama iznad 2 mm		Frakcija sa česticama ispod 2 mm	
LE	90,20%	LE	90,26%	LE	89,12%
Cl	3,68%	Cl	3,85%	Cl	4,00%
Fe	2,27%	Fe	1,67%	Fe	2,29%
Ti	1,33%	Ti	1,95%	Ti	1,42%
Zn	0,65%	Zn	0,42%	Zn	0,67%
Ca	0,59%	Ca	0,72%	Ca	0,60%
				Mg	0,88%
Pb	94 ppm	Pb	175 ppm	Pb	135 ppm
Hg	ND	Hg	ND	Hg	ND

Kako bi rezultati analize bili vjerodostojni pristupilo se postupku homogenizacije uzorka. Iz pribavljenje nehomogene krute poliuretanske pjene, izdvojeno je 50 grama mješavine koja se sastojala od raznih veličina čestica. Korištenjem sita, mješavina je podijeljena na osam frakcija sa različitim veličinama čestica. Podijela prema veličina čestica te pripadajuća izmjerena masa frakcija prikazana je u Tablici 3.

**Tablica 3- Podijela mješavine na frakcije**

Veličina čestica (mm)	Masa frakcije (g)
Iznad 2,0	2,215
1,0-2,0	3,515
0,5-1,0	7,532
0,25-0,5	7,548
0,125-0,25	11,259
0,063-0,125	11,111
0,045-0,063	4,372
Ispod 0,045	0,028

Iz Tablice 3, vidljivo je da suma masa svih frakcija sa veličinom čestica iznad 0,25 mm, otprilike odgovara sumi masa frakcija sa česticama ispod 0,25 mm. Upravo iz tog razloga veličina čestica 0,25 mm, odabrana je kao granična vrijednost za homogenizaciju uzorka. Temeljem toga, uzorak je podijeljen na tri homogene frakcije koje su kasnije korištene prilikom toplinske analize i to kao:

- Frakcija sa veličinom čestica iznad 0,25 mm
- Frakcija sa veličinom čestica ispod 0,25 mm

- Frakcija sastavljena od jednakog udijela čestica iznad i ispod 0,25 mm

Toplinska analiza sastojala se od pirolize spojene sa plinskom kromatografijom i masenom spektrometrijom (Py/GC-MS). Korišteni pirolizator bio je Pyroprobe 5200 (CDS Analytical Inc.), direktno spojen na plinski kromatograf (HP Agilent 7890 A) te maseni spektrometar (5975 C). Ispitivani uzorci imali su između 100-200  $\mu\text{g}$ , a ispitne temperature iznosile su 500, 600 i 700  $^{\circ}\text{C}$ . Uzorak je bio izložen na tim temperaturama 10 sekundi. Spoj između pirolizatora i kromatograma bio je zagrijan na 285  $^{\circ}\text{C}$  kako bi se izbjegla kondenzacija pirolitičkih produkata. Plinska smjesa ubacivana je u kromatogram automatski u split modu 1/100. Temperature elektronskog ionizatora i detektora održavana je na 230 i 150  $^{\circ}\text{C}$ . Identifikacija i kvantifikacija produkata degradacije, odrađena je korištenjem unutarnjih i vanjskih standarda te ostale pripadajuće literature korištene prilikom ovakvih istraživanja.

S obzirom na obujam i kompleksnost prikaza rezultata toplinske analize, u ovom dijelu biti će predstavljeni samo određeni dijelovi, što nikako ne znači da se ostatak rezultata može zanemariti. Kako bi se odredio kinetički mehanizam termalne dekompozicije ispitivanog uzorka, on je podvrgnut pirolizi u oksidirajućoj i ne-oksidirajućoj atmosferi. Na Slici 4, nalazi se TG krivulja degradacije poliuretanske pjene u atmosferi zraka. Iz krivulje je vidljivo da se postupak degradacije sastoji od tri koraka, te da neizgoreni ostatak iznosi oko 10% početne mase. Dobiveni rezultati odgovaraju početnim pretpostavkama, s obzirom da veliki broj prijašnjih istraživanja ukazuje na sličan ili identičan mehanizam termalne dekompozicije[12-14].

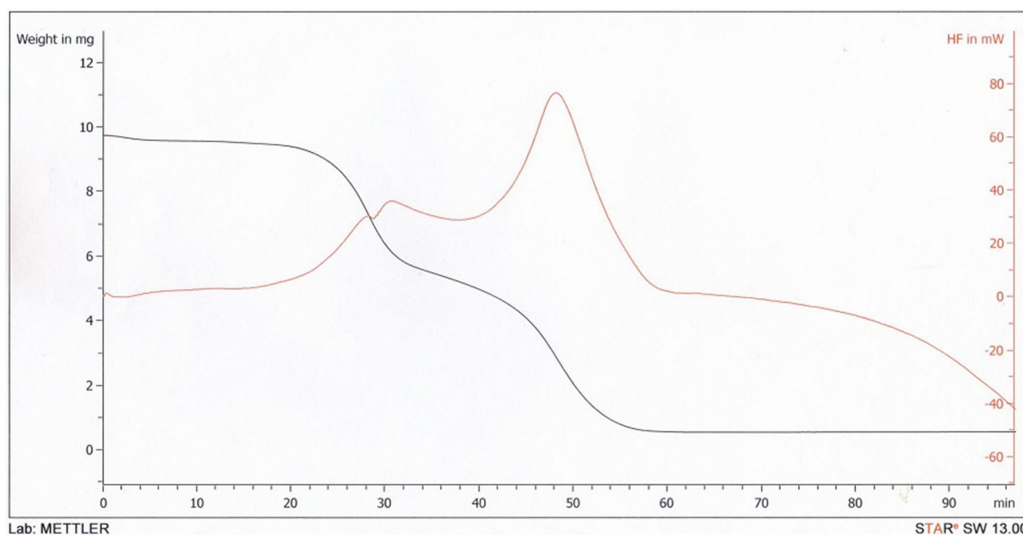

Slika 4- TG krivulja degradacije u atmosferi zraka

U atmosferi dušika, koji je inertan plin, degradacija poliuretanske pjene sastojala se od dva koraka, a neizgoreni ostatak na kraju procesa iznosio je oko 20%. Rezultati te analize, također su očekivani s obzirom na iskustva prethodnih istraživača [12-14].

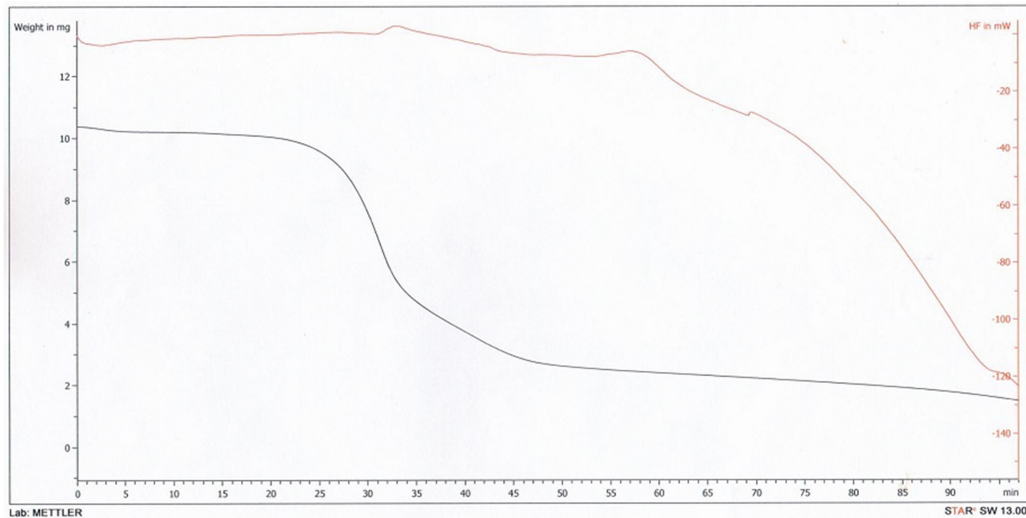

**Slika 5- TG krivulja degradacije u atmosferi dušika**

Kako bi se ispitao potencijal energetske uporabe otpada, puno je važnije ispitati organski sastav i plinske produkte njegove termalne dekompozicije. Analiza organskog sastava, pokazale je prisutnost velikog broja raznih organskih skupina i spojeva kao produkata toplinske degradacije. Kod svih ispitivanih frakcija zabilježen je dominantan udio spojeva koji sadrže dušik (amini i amidi), a njihov udio kreće se od 40% u nehomogenoj smjesi do preko 80% u homogeniziranim frakcijama. Udio ostalih organskih skupina i spojeva snažno je ovisan o stupnju homogenosti uzorka. Osim spojeva sa dušikom, identificirane su slijedeće skupine organskih spojeva: aromatski ugljikovodici, alkani, alkeni, alkadieni, aldehidi, furani, nitrili, alkoholi, eteri, karboksilne kiseline, alkanoti, ftalati, oksirani te policiklički aromatski ugljikovodici. Kao što je utvrđeno spektroskopskom analizom, udio klora u uzorku prelazi dopuštene vrijednosti te uvelike smanjuje mogućnost korištenja analizirane poliuretanske pjene kao goriva iz otpada. Također, vrlo je važno analizirati nastale organske spojeve koji sadrže klor. Na Slici 6, prikazane su koncentracije spojeva koji sadrže klor za ispitivane frakcije i smjese. Vidljivo je da homogenizacija uzorka, nužno dovodi do velikog smanjenja koncentracije spojeva koji sadrže klor, ali i sam broj tih spojeva. Kod nehomogene smjese detektirano je 11 spojeva koji sadrže klor, dok je taj broj kod homogeniziranih frakcija bio najviše sedam. Nadalje, kod nehomogene smjese detektirani su i spojevi koji uz klor sadrže i fluor. Takvi spojevi su strogo nepoželjni zbog svog potencijalnog razarajućeg

djelovanja na samo postrojenje, u prvom redu korozivno djelovanje, ali i veliku opasnost koju izazivaju za ljudsko zdravlje.

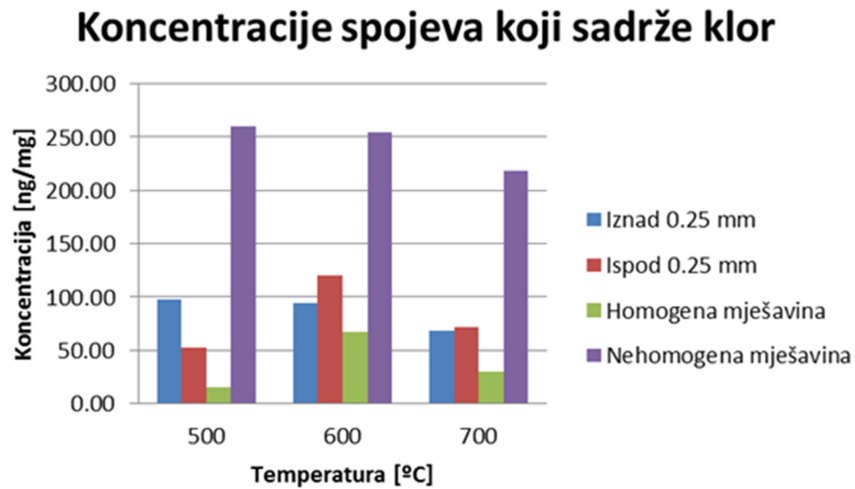

Slika 6- Koncentracije spojeva koji sadrže klor

Organski spojevi koji također zahtijevaju pažljiv pristup su policiklički aromatski ugljikovodici (PAHs) [15]. Najveće koncentracije ovih spojeva zabilježene su kod nehomogene smjese, ali njihov udio ne prelazi više od 0,03%. Slika 7 prikazuje zabilježene količine tih spojeva kod nehomogene smjese na svim pirolitičkim temperaturama. Također, važno je napomenuti da je homogenizacija uzorka dovela do drastičnog smanjenja koncentracije tih spojeva u homogenim smjesama te je njihova prisutnost zabilježena u tragovima. Nadalje, homogenizacija je dovela do potpune eliminacije izrazito štetnih ftalata [16], furana [17] i oksirana, čija je prisutnost zabilježena u nehomogenoj mješavini.

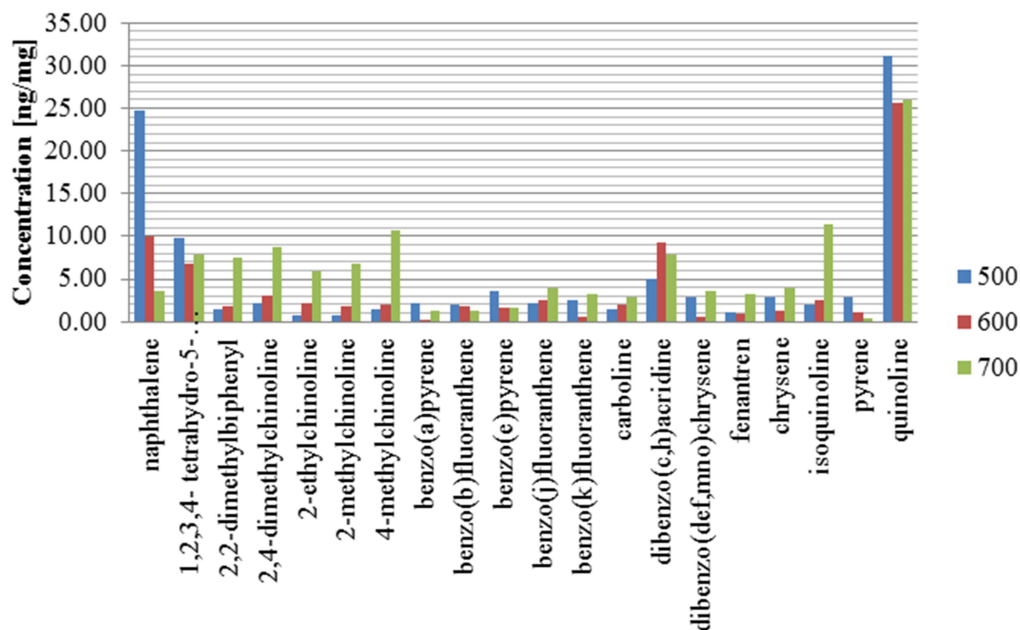

Slika 7- Koncentracija Policikličkih aromatskih ugljikovodika u nehomogenoj mješavini

Kod analize plinskih produkata vidljiv je dominantan utjecaj emisija ugljikova dioksida ( $\text{CO}_2$ ) te raznih dušičnih oksida ( $\text{NO}_x$ ). Njihov udio kreće se između 45-78%, ovisno o ispitivanoj smjesi. Također, značajane emisije zabilježene su i za freon CFC-11, najviše 14%. S obzirom da je upotreba navedenog freona zabranjena, a njegova štetnost velika, ovakav udio zasigurno je zabrinjavajući. Također, zabilježene su i značajne količine amonijaka ( $\text{NH}_3$ ) u svim uzorcima te nekih izrazito štetnih alkalnih oksida kod nehomogene mješavine. Važno je napomenuti da su plinski produkti detektirani samo sa svojim udjelima, dok stvarna emitirana količina zbog tehničkih ograničenja opreme nije poznata. Slika 8 prikazuje udjele plinskih produkata homogene smjese sa česticama iznad i ispod 0,25 mm na ispitnim temperaturama.

### Plinski produkti

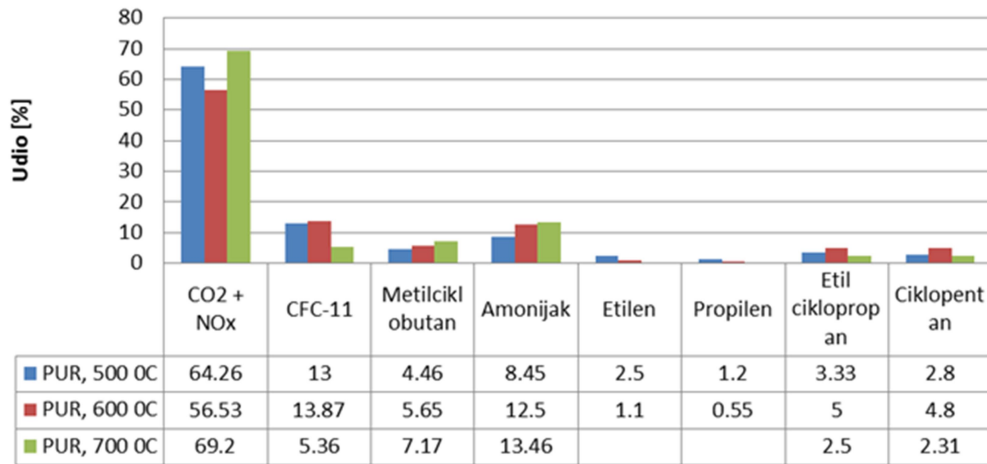

Slika 8- Plinski produkti homogene smjese sa česticama iznad i ispod 0,25 mm

Piroliza svake od osam navedenih frakcija iz Tablice 3, trebala je prikazati utjecaj veličine čestica na produkte termalne dekompozicije. Također, rezultati te analize mogu biti od velike koristi prilikom proizvodnje goriva iz otpada, s obzirom da jasno prikazuju produkte degradacije za svaku zasebnu frakciju. Ukoliko određena frakcija posjeduje izrazito štetne organske spojeve i plinove, nju se može izdvojiti iz proizvodnje goriva. Analiza organskih spojeva pokazuje da dodatna homogenizacija te podijela na izrazito male frakcije značajno smanjuje proizvodnju istih. Ispitivane frakcije imale su prilično sličnu strukturu organskih spojeva sa dominantnim utjecajem amina i amida (55-82%). Ostale organske skupine i spojevi djelomično se razlikuju ovisno o frakciji, ali njihovi udjeli često su gotovo zanemarivi. Važno je napomenuti da su ovakvom dodatnom frakcinacijom značajno smanjenje koncentracije spojeva sa klorom, na najviše 21 ng/mg. Također, koncentracije policikličkih aromatskih ugljikovodika izrazito ovise o ispitivanoj frakciji te se kreće u rasponu od 68 ppm za frakciju sa veličinom čestica ispod 0,045mm do 136 ppm za frakciju sa veličinom čestica iznad 2 mm. Analiza plinskih produkata ispitivanih frakcija, prikazuje izrazito interesantne rezultate (Slika 9). Emisije CO<sub>2</sub>-NO<sub>x</sub> i dalje ostaju dominantne za sve frakcije. Produkcija štetnih emisija freona CFC-11 izrazito je visoka kod određenih frakcija te njihov udio iznosi i do 42,5%. Emisije tog freona generalno su povišene kod gotovo svih frakcija. Zanimljivo je primjetiti pojavu klorometana i ponovnu pojavu propilen oksida koji je bio eliminiran prethodnom homogenizacijom.

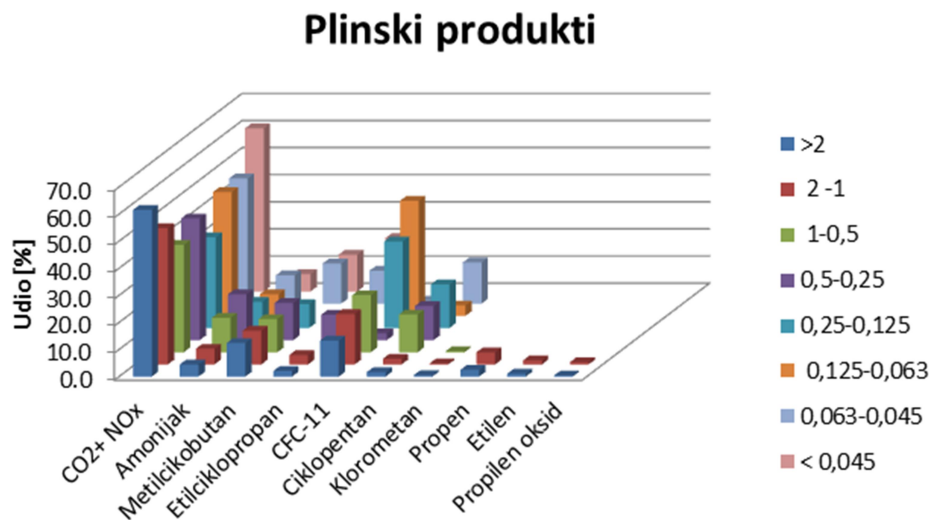

Slika 9- Plinski produkti ispitivanih frakcija na 600°C

Analiza krute poliuretanske pjene daje detaljan uvid u njen sastav. Također, analiza je prikazala njeno ponašanje prilikom termalne degradacije, kao i produkte koji nastaju prilikom tog procesa. Na kraju, izveden je zaključak sa smjericama i potencijalima za buduća istraživanja.



## **1. Introduction**

Many different materials are used in everyday life. One of the most used group of materials are polymers, which are used in wide range of applications. Depending on their application, chemical structure and composition may vary significantly. In general, polymers are chemicals with repeating basic unit, called “mer”. Therefore, polymer literally stands for a material with repeating units, mers. Furthermore, polymers may be natural or synthetic. Synthetic polymers, which are mostly used, are derived from fossil fuels, therefore they have high share of carbon atoms. Having high share of carbon, hydrogen and oxygen is usual for organic compounds and when they are united, various groups can be created such as hydrocarbons, sugars, alcohols, fats, esters, etc. Presence of nitrogen and sulphur is a base for creation of alkaloids, amino acids, rubbers, etc. [18].

Polymers are recyclable materials, but within every recycling cycle their quality and applicability is downsized. At the end of a life time, derived waste materials needs to be managed properly since their high pollution potential. Constant increase in usage of such materials raises concern about successful handling of their waste. European Commission banned landfill disposal without pretreatment of waste (1999/31/EC) [1]. Their chemical constitutions and share of mentioned elements, gives them high calorific value. This property makes them interesting for investigation as a possible energy source. They can be used for energy recovery in incinerators or for co-combustion as a partial replacement for fossil fuels. Not only that significant amount of energy which is used during the production can be recovered, but thermal recycling can be highly effective method for their waste management. Thermal procedures are very effective in reducing the volume of the waste, as well as for destroying pathogens. European Union considered this method effective in reducing the greenhouse emissions and a potential solution for growing waste disposal problem. Nevertheless, energy recovery should be the last step in recycling hierarchy and it is regulated with directive 2010/75/EU [11]. The study objective of Thesis was to determine whether selected Waste Rigid Polyurethane Foam (WRPUF) can be used for waste-to-energy applications [19] [4].

During polyurethane foam production, considerable amount of different chemical elements (chlorine, fluorine, etc.) and their compounds is used for purposes such as: stabilizers, plasticizers, catalyst, flame retardants etc. [2]. Presence of this chemical species demands detailed analysis of a sample, since they may form various hazardous organic

compounds and gaseous products. Different investigations techniques are invented in order to examine the properties of chemical species. For the investigations of polymers, most commonly the Thermal analysis is used. Thermal analysis is a group name for different techniques which are examining changes in sample properties as a function of temperature. One of this technique, Thermogravimetric analysis (TGA) has been used for the purposes of this Thesis. This technique has been coupled with Gas chromatography- mass spectrometry (GC/MS) in order to examine the yield of organic compounds and gaseous products from the selected sample.

Sample has been conducted to different investigations to examine the temperature influence and grain size effect on the yield of organic compounds and gaseous products. After results have been obtained, they were analyzed and compared to similar previous investigations.

### **1.1. Polyurethanes**

Polyurethane (PU) is a polymer composed of organic compounds. The production of polyurethane requires two main liquid components; a polyol and a polyisocyanate. Polyurethane is produced when polyol (an alcohol with characteristic hydroxyl OH-group) is mixed with diisocyanate (chemical compounds with isocyanate groups NCO-) in the presence of suitable additives and catalysts. During this chemical reaction, a considerable amount of heat is released which is used partially to evaporate volatile liquids. As a result, the reaction mix is expanded and forms a foam [2].

Because of the variety of a polyols and diisocyanates that can be used for a polyurethane production, a wide spectrum of a materials can be produced from it. Polyurethane properties are determined by the chemical nature of the polymer building stocks, stoichiometry of the isocyanate/OH components. Catalyst and other additives such as flame retardants, stabilizers, etc. also have an impact on PU properties. Polyurethanes are produced in a wide range of density, which implies that final product can be low density foam ( $6 \text{ kg/m}^3$ ) or solid polyurethane elastomer ( $1\ 300 \text{ kg/m}^3$ ). Another important characteristic of polyurethane is that it can be produced in different range of hardness or rigidity, from flexible to rigid. This two characteristics made polyurethane present in different type of industries in different form [19]. Global plastic production is constantly increasing and in 2015 was 322 million tones (all types of plastic included), and around 16,1 million (5%) were polyurethane materials. Biggest

plastic producer is China with 28% share, and it is expected that global production will arise even more in future [20].

## 1.2. Polyurethane foams (PUFs)

Most common application of PUs is in form of foam. Approximately 66% of polyurethane raw materials are used for foam production. First step of producing polyurethane foam is reaction between water and isocyanates, which leads to creation of unstable carbamic acid, which slowly decomposes to amine and carbon dioxide. Additional isocyanates is given to react with amines in order to create a urea groups, which are foundation of every polyurethane. Carbon dioxide is used in process as a blowing agent which helps to create a foam [3]. Polyurethane foams are easily ignitable and highly flammable materials. Since their structural diversity, during the combustion process they produce highly toxic products which contain high concentration of hydrogen cyanide and carbon monoxide. In order to achieve the full potential and applicability of such a material, flame-retardants additives may be used. Flame-retardants can be chemical components incorporated into the structure of material, but also it is possible to use particular coating materials which are applied to the material surface. While using such additives, a lot of attention must be given to their influence on physical and chemical properties of polyurethane foams, since they can influence it significantly [21].

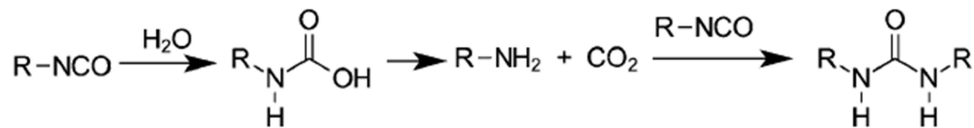

**Figure 1-Formation of PU foam from the reaction between isocyanates and water [3]**

Flexible polyurethane foam is used as cushioning for a products in different industries such as bedding, furniture, automotive interiors, carpet underlay etc. Possibility of shaping and molding it into different forms, combined with long term use characteristics, has made flexible PU as one of the best technical material available on market. Production of flexible polyurethane foam is divided into two classes: conventional flexible foam and highly resilient flexible foam. Those two groups cover more than 90% of market needs. Their wide range of density combined with possibility to create required properties for each application, has made this material one of the best available on market [3].

Rigid polyurethane foam, (PUR), is also presented in different application and different industries. It is produced the same way as flexible polyurethane foam, with exception that polyols before entering the reaction with water are treated with Methylene diphenylene diisocyanate (MDI). This procedure creates strongly cross-linked, closed-pore materials. Density of produced material can be regulated by adding the blowing agent or by the formation of CO<sub>2</sub> which is produced by reaction between isocyanates and water [2].

One of the most important properties of rigid polyurethane foam is insulation capability. This property coupled with possibility of using PUR as a structural material, has made this material presented in construction industry, refrigeration and tubing/piping industry.

Even though, share of PUR as insulation material on market was around 14% in 2011 [3], it is continuously increasing. It shows much better insulation properties compared to dominating polystyrene and mineral wool materials. Also, PUR allows excellent insulation characteristics achieved with thinner material which results with reduced space requirements.

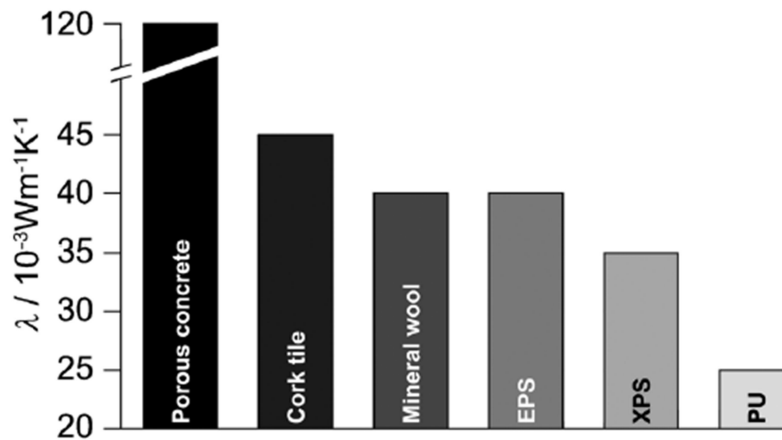

Figure 2- Thermal conductivity values of various insulation materials [3]

Thermal conductivity of rigid PU is determined by density, blowing agent and the pore structure in foam. Standard foam density is around 30 kg/m<sup>3</sup>, with pore sizes in the region of 200 μm. Since the pore gas is mainly in charge for heat transfer, and its thermal conductivity is not higher than 0,014 W/mK, rigid polyurethane foam as insulation material can achieve low thermal conductivity with not more than 0,024 W/mK, as can be seen in Figure 2.

The biggest challenge in production of PUR as insulation material is to reduce their flammability. This can be achieved by adding flame retardants, which classify rigid polyurethane foam as having low or normal flammability.

Another important application of rigid polyurethane foam is in refrigeration industry, where foam is used as major insulation material with presence of 95% in all refrigerators produced nowadays. Biggest advantage of PUR over other materials is possibility to filling complex cavities after being injected in reactive liquid form. This capability followed by good adhesion and mechanical properties, make PUR ideal structural material in refrigeration industry. As was mentioned above, thermal conductivity depends on its cell size. Nowadays, it is possible to achieve cell size bellow 150  $\mu\text{m}$ , which can ensure excellent insulation performance without negative impact on other characterizes.

Finally, rigid polyurethane foam is standard insulation material in piping industry, insulation of hot water tanks, boilers, etc. Possibility of high efficiency insulation over temperature range from  $-196\text{ }^{\circ}\text{C}$  to  $+150\text{ }^{\circ}\text{C}$ , followed by capability of adopting required specifications individually, ensures that PUR will remain as one of the most important insulation material in future [3].

### **1.3. Polyurethane recycling process**

Like every other polymer, polyurethane is also recyclable. There are two primary ways of recycling: mechanical (material is re-used in its polymer form) and chemical (material is transformed back to the primary chemistry constituents). Mechanical recycling consists of grinding, powdering or rebonding polyurethane foam waste. Chemical recycling, on the other hand, consists of chemical process which convert polyurethane foam waste into it raw constituents or some type of oil and gas. Some of the possible processes are glycolysis, hydrolysis, pyrolysis or energy recovery. Biggest challenge which occurs in the recycling process of PUs foam wastes is derived from their low density, which is followed by large volume. It is known that in 1991, production of PUR in Japan was 1.5 wt% in plastic industry, while it volumetric share was about 30% [22]. For that reason, techniques which have the possibility of minimizing the volume of such a waste, especially their residue, have a great advantage in application and are part of numerous investigations performed nowadays.

Energy recovery is especially interesting, because it opens the possibility of co-combustion process between some fossil fuels and waste PUR or municipal solid waste

(MSW). Polyurethane can significantly increase the energy efficiency of such process because of its high energy value. Energy recovery is also important for the polyurethane which has reached its recyclable potential.

#### **1.4. Previous investigations related to thermal degradation of rigid polyurethane foams**

Since polyurethanes are produced in wide spectrum of products their compositions and properties varies significantly. In order to determine if specific polyurethane is suitable for incineration or co-combustion usage as refuse-derived fuel (RDF), laboratory investigation needs to be performed to detect and analyze constituents which occur and are produced as a result of this process. Pyrolysis and combustion are showing great perspective in dealing with PUR waste, since they reduce waste volume significantly. Nevertheless, this technique provides an opportunity for co-combustion processes with fossil fuels, which can result in substitution of fossil fuels and decreasing their usage, while simultaneously dealing with serious problem as it is disposal of polyurethanes or plastic products in general. Application of waste-to-energy is also promoted as possibilities for decreasing the concentration of greenhouse gases (GHG). According to Austrian Whitebook from 2010, country with great experience in incineration of waste, this method could avoid producing around 110 million tons of CO<sub>2</sub> equivalents per year in European Union [23].

Pyrolysis and combustion mechanism, followed by characterization of polyurethane constituents have been studied by other authors previously. Herrera et al. [24] studied thermal degradation and evolving products of pyrolysis rigid polyurethane foam in nitrogen atmosphere using thermogravimetry analysis (TGA) coupled with mass-spectrometry (MS) and Fourier-transform infrared spectroscopy (FTIR). To get full characterization of evolving products from about 40 mg sample, gas-chromatography-mass spectrometry (GC/MS) as well as high performance liquid chromatography analysis coupled with fluorescence detection (HPLD-FD) was used. Focus of this investigation was formation of polycyclic aromatic hydrocarbons (PAHs), especially amino-PAHs, cyanic-PAHs and nitro-PAHs. Font et al. [25] studied thermal degradation of polyurethane in an inert atmosphere and different heating rate. Gas chromatography-mass spectrometry (GC-MS) was used to identify volatile and semi volatile organic compounds as the products of the degradation. This work present thermal degradation mechanism of polyurethane and propose a kinetic model for it. Furthermore, valuable and detailed information about evolving products and their yield is presented which

can be used for comparison of the results. He et al. [13] studied thermal degradation of rigid polyurethane foam in oxidative and non-oxidative atmospheres. Results of TGA-FTIR investigation showed that presence of oxygen began to accelerate thermal degradation while in nitrogen atmosphere, degradation appeared with delay. In gas phase, TGA-FTIR coupled with gas chromatography-mass spectrometry was used to detect characteristics products of thermal degradation and more than 20 products were identified. This investigation presented thermal degradation mechanism of insulation rigid polyurethane foam as well as the difference in evolving products of such process depending on its atmosphere. Guo et al. [26] studied pyrolysis of waste rigid polyurethane foam (WRPUF) depending on the four operational parameters: particle size, temperature, sweeping gas flow rate and catalyst addition. Focus of the research was evolving nitrogen containing products of thermal degradation and possibilities of their concentration reduction by adding suitable catalyst. Gas chromatography-mass spectrometry was used to identify the products of thermal degradation, as well as Pareto's standardized chart in order to present the influence of particular catalyst. Results of this investigation may be very useful in future in order to reduce the yield of N-containing products in pyrolysis of WRPUF, if it is used as energy source for power generation. Guo et al. [27] in their another work studied the influence of metallic catalyst on the nitrogen migration in pyrolysis and gasification process of waste rigid polyurethane foam. Presented results show that gas yield is much higher in gasification process than during pyrolysis. Also it is shown that gasification generates more volatile nitrogen, but predominant N-containing species among all products remains, environmentally friendly  $N_2$ . Furthermore, it is presented the influence of particular metallic catalysts on the formation of N-containing species and it is visible that none of them successfully decrease the yield of toxic gases; in fact some of them increase their yield. Wang Hui et al. [12] studied influence of isocyanate index on the pyrolytic behaviors and kinetics of the rigid polyurethane foam. For the analysis it was used thermogravimetry analysis (TGA), Fourier-transform infrared spectrometry (FTIR) and synchrotron radiation vacuum ultraviolet photoionization mass spectrometry (SVUV-PIMS). Investigation was carried out under nitrogen atmosphere on a three different samples with different isocyanate index. Results show that pyrolysis process can be divided into two temperature areas, from room temperature up to 400 °C and above 400 °C. Furthermore, samples with higher isocyanate index had reduced kinds of the pyrolysis products as well as they increment of the activation energies. Jiao et al. [14] studied thermal degradation of rigid polyurethane foam in nitrogen and air atmosphere. Results of thermogravimetric analysis shows that in nitrogen atmosphere decomposition consists of two-

steps, while in air there is three steps. Differential-scanning calorimetry (DSC) shows that decomposition in nitrogen atmosphere is endothermic, while in air atmosphere it is strongly exothermic, with huge heat release. In general, degradation process of PUF is accelerated in air atmosphere for about 50 °C and amount of residue proves that decomposition with presence of oxygen is more likely to be completed, compared to one in nitrogen atmosphere. Coupled TG-FTIR-MS were used to identify evolving gas products. From the results of that procedure it is visible that gaseous products are generated in three stages in different temperature range. HCFC-141b, which served as a blowing agent, was released at initial stage of decomposition with highest yield at around 150 °C.



## **2. Material and Methods**

The study methods can be divided into two groups: one which deals with identification and quantification of chemical elements present in sample and one which study kinetic mechanism and properties behavior under imposed condition. Identification and quantification of elements in sample is presented as Ultimate and Proximate analysis, occasionally supported by some spectroscopic technique. Proximate analysis is carried out to examine various parameters of combustible components in the sample. Observed parameters include moisture content, volatile combustible matter, fixed carbon and ash content. Ultimate analysis examines the share of combustible elements presented in the sample. Focus of this procedure is to quantify the share of hydrogen, oxygen, nitrogen, carbon, sulphur and ash. As a result of Proximate and Ultimate Analysis, heating value can be estimated as well as the potential for incineration or co-combustion of the investigated sample [28].

In order to determine physical or chemical properties of substances which are used every day, numerous investigation technique and methods has been developed so far. One of the most important technique, which is used for a long time in order to determine different material properties is thermal analysis. Thermal analysis is a group name for many different thermal techniques of investigation. Thermal analysis implied that certain properties of the material changes with temperature alteration. Also, thermal analysis is often referred as a study of a heat transfer through the material structure. Most important measurements which may be obtained from such analysis are connected to thermal conductivity and heat capacity. There are 11 different techniques which are used commonly. Every method can be used for itself, but also it is possible to use two or more methods simultaneously. If the methods are used simultaneously, special attention should be given to operating conditions of the procedure [7].

### **2.1. X-ray Fluorescence Analysis (XRF Analysis)**

X-ray fluorescence analysis or simply XRF spectroscopy is well known laboratory technique for identification and quantitation of the elements from the material sample. Ultimate and proximate analyses provide us with important information related to the share of elements in the sample, but only those who are relevant for combustion process. Therefore, to identify as much as possible elements and to determine the composition of a sample, XRF Analysis is used. Simplicity of the method as well as the wide range of application, occasionally

followed by no-need for sample preparation, holds this technique highly preferable for nowadays elemental or chemical analysis [10].

### 2.1.1. Fundamentals of XRF spectrometry

In order to understand the principles of this technique it is necessary to be familiar with Bohr's atomic model (Figure 3), since the method is directly dependable on it. All atoms have a fixed number of electrons (negatively charged particles) arranged in orbitals around their nucleus. Since the atoms are neutral charged substances, number of electrons has to correspond and be equal to the number of protons (positively charged particles) in nucleus. Electrons around nucleus are moving in strictly define areas, known as shells. Shells are labeled with the letters K, L, M, N etc., the innermost shell is K, then followed by others as they are listed. All electrons are bonded to the atom nucleus by binding energy. Binding energy stands for the minimum amount of energy required to release the electron from the shell and it is decreasing as the distance from nucleus is greater.

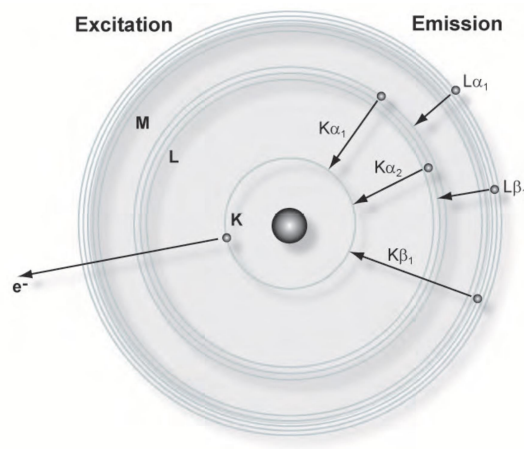

**Figure 3- Bohr's atomic mode, shell model**

If the electron from the inner shell is exposed to the irradiation of energy higher than it is his ionization energy, it will be separated from the atom. Electron from the higher shell will then fall into the “hole” in order to restore the stability of the atom. As a result of this actions, energy equivalent to the distance between shells is released and it is emitted either as an X-ray photons or is transferred to another atomic shell electron (Auger effect). If the case is former, this phenomena is called fluorescence yield, and it is ground stand floor for XRF spectroscopy. Fluorescence yield or fluorescence light is different for every element; therefore emitted X-rays photons from particular element are called characteristics X-rays. Since the energy difference between two special orbital shells, in a given element, is always

the same, the photon emitted as a result of these actions, will always have the same energy. For that reason, by determining the wavelength or emitted energy of the emitted photon (X-ray fluorescence) for the particular element, it is easily possible to identify that element. Emitted energy is named after the shell from which it is emitted (i.e. K-radiation, energy released after replenishing K-shell) [5] [29]. This phenomenon is described by Planck's Law:

$$\lambda = \frac{hc}{E} \quad (1)$$

$\lambda$ - wavelength [nm]

h- Planck's constant

c- speed of light [m/s]

E- emitted photon energy [J]

### 2.1.2. Operating conditions

In order to achieve the emission of the characteristic X-ray, elemental atom must be destabilized. For that purpose, electrons from innermost shells are radiated with the amount of energy that exceeds their binding energy, which leads to release of the electrons and emission of the characteristic X-rays photons.

Irradiation of the elements is achieved by X-ray tube, which has been proven as simplest and safest technique. Primary X-ray photons typically are focused on knocking out the electrons from shells closest to the nucleus K, L and M. Once atom is destabilized, electrons from the higher shells will replace those from innermost shells, as the result of such an action, secondary X-rays will be emitted. Intensity of the secondary X-rays depends on the excess of the energy which remains after the electron switches from higher to lower energy level.

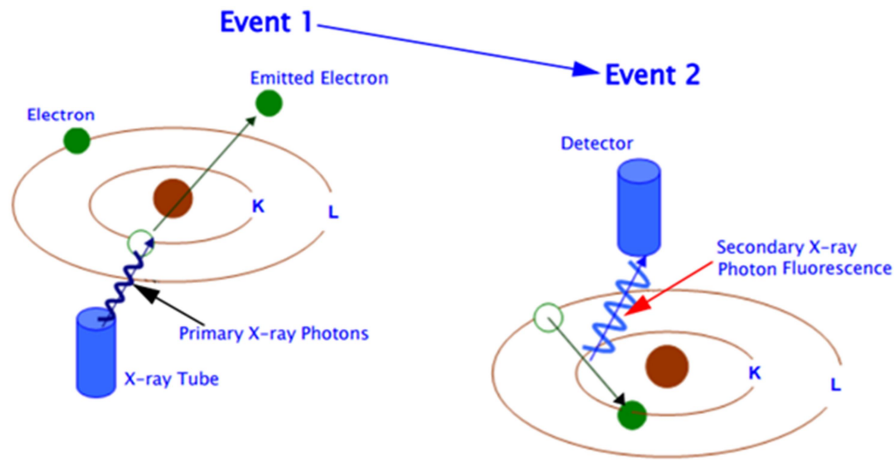

**Figure 4- Illustration of XRF spectrometry [5]**

Secondary emitted X-rays are detected and identified by detectors, as it can be seen from Figure 4. Since the XRF-spectroscopy is not only qualitative, but quantitative method as well, detectors must be capable of measuring the pulses of the secondary X-rays. Pulses present the number of X-ray photons emitted from the sample per unit of time. Pulses per second or counts per second represent the intensity of secondary X-rays and presents the approximation of the concentration of the emitting elements in the sample. Besides being absorbed by material, X-rays when impinge the sample may also be scattered or transmitted. When X-ray is scattered with no change in energy, this is called Rayleigh scattering, and when some amount of energy is lost, the phenomena is Compton scattering. Scattering in general is not desirable phenomena because it creates high levels of background radiation, which may cause multiple problems in procedure as well as in the results analysis. Since light elements have low capability of absorption, scattered radiation is higher compared to the heavy elements. When X-ray photons are identified by their wavelength as well as their pulses, corresponding peak in spectrograph is plotted. When investigation is done, results of XRF spectrum may be presented in form of a chart or table. In the chart, y-axis stands for intensity of the detected element, while x-axis stands for the material wavelength or emitted energy [29].

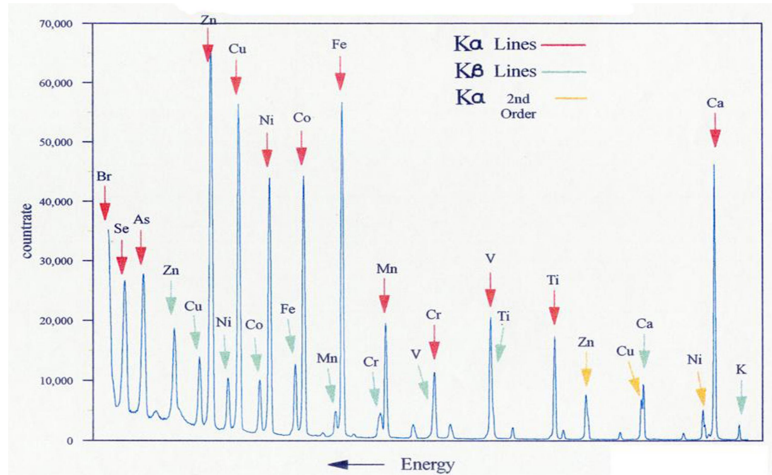

Figure 5- Example of an XRF spectrum [30]

### 2.1.3. Instrumentation

Instrumentation which is nowadays used for XRF analysis can be divided into two categories: energy-dispersive (ED) and wavelength-dispersive (WD) spectrometers. Due to instrumental limitations lightest element that can be analyzed is Beryllium ( $Z=4$ ), even though in general, elements lighter than sodium ( $Z=11$ ) are often difficult to quantify without background corrections [6].

In energy-dispersive spectrometers (EDX or EDS), when photon is detected, detectors determine the amount of released energy and identify the element. EDX spectrometers in general are smaller, simpler and occasionally used for portable quality controls. Because of their simplicity and usage of miniature X-ray tubes, the accuracy and resolution of EDX spectrometers is lower compared to wavelength spectrometers (WDX). Results once acquired as spectrum are subjected to large degree of processing by computer software before being ready for analysis.

Wavelength-dispersive spectrometers (WDX or WDS), use diffraction to separate photons on a single crystal before detecting them. Biggest advantage compared to EDX spectrometers, besides better resolution, is capability of measuring only wavelengths of interest. This can be achieved in two ways, sequential and simultaneous. Sequential spectrometers have a single “channel” for detecting the elements. Therefore, instrument must move through the spectrum wavelengths to identify particular element. Unlike that, simultaneous spectrometers can detect and identify more than one element without moving through spectrum, since they had numerous “channels” for element detection [5].

## **2.2. Thermal analysis**

Thermal analysis (TA) means the analysis of a change in a sample property, which is related to an imposed temperature alteration [7].

Definition above is one of many existing definition and so far, there is no uniform definition accepted. Thermal analysis is scientific method to determine material behavior and property changes during the exposure to a higher temperature or a temperature alteration. Change of a property and temperature alteration presents the essential part of a Thermal analysis.

Property of sample includes thermodynamic properties, material properties, chemical composition or structure. Change of the property is measured by a signal, which indicates some changes in sample. This change, and not a property of a sample, is used to determine some property of interest. Temperature alteration or change of temperature can be predetermined or sample-controlled. Predetermined temperature means that temperature change during experiment is programmed before. On the other side, sample-controlled alteration means that feedback signals from sample determine the temperature of a sample environment. There are four possible scenario of temperature alteration:

- Stepwise change from one temperature to another, isothermal mode of operation
- Constant heating or cooling (linear rate of change of the temperature)
- Constant or a linearly changing temperature with constant frequency and amplitude
- Free or uncontrolled heating or cooling [7]

### **2.2.1. Classification of methods**

Different measuring technique, consequently different measuring instruments has been developed for thermal analysis. Primary classification is made by the property which is to be investigated and it is listed in Table 1. There are also some additional classification criteria that are used as secondary classification and they exist to determine methods from primary classification more detailed.

**Table 1- Primary classification of Thermal analysis methods [7]**

Property under study	Method	Abbreviation
Temperature	Heating/cooling curve	
Temperature difference	Differential Thermal Analysis	DTA
Heat	Calorimetry	
Mass	Thermogravimetric analysis	TGA
Mechanical properties	Thermomechanical analysis	TMA
Pressure	Thermomanometric analysis	
Electrical properties	Thermoelectrical analysis	TEA
Magnetic properties	Thermomagnetic analysis	
Optical properties	Thermooptical analysis	TOA
Acoustic properties	Thermoacoustic analysis	TAA
Chemical composition	Different methods	

There are different modes of operation in thermoanalytical methods. One can be static mode, where any quantity acting on the sample is constant in time, and other one is dynamic mode, which implies any alteration with time.

Furthermore, method of measurement can be differential or simultaneous. Differential methods of measurement compare the quantity of a sample with the quantity of a reference sample, under the same experimental conditions. Quantity value of a reference sample is known and difference between measured and known values is object of investigation. A simultaneous method of measurement consists of two or more techniques applied on a single sample. Figure 6, presents scheme of the measuring devices [7].

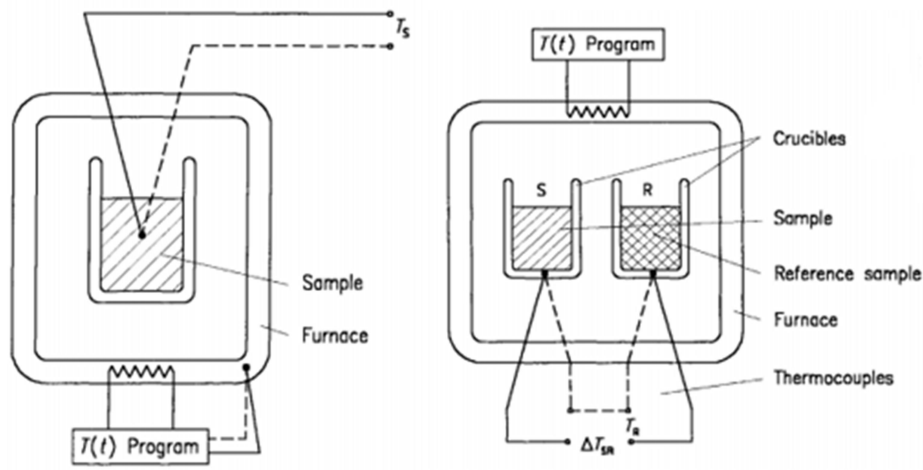

**Figure 6- Devices to determine TG curve and DTA curve [7]**

### 2.2.2. General specifications of the instrument

General specifications include information such as type of a measuring instrument (dilatometer, thermobalance, etc.) and some details of a design, which describes how system works. Furthermore, general specification provides information about temperature range of an instrument, environment atmosphere that can be simulated during experiment and heating or cooling rates with temperature-time programs. Additional information that may be given for detailed characterization consists of a view to the sample to be investigated and includes following information: kind of a sample (solid, liquid, gaseous), suitable sample volume and mass, suggestions about sample dimension, mass changes that can be registered etc. Furthermore, general specification may give information about instrument operability. If the instrument may be used for simultaneous measurement technique, their possible combinations are indicated (e.g. DTA/TG, TG/EGA, etc.).

Performance criteria for characterization are obtained from the measured curve. Some performance criteria are not relevant for every thermoanalytical instrument. Following performance criteria are used in characterization:

- Noise
- Repeatability
- Linearity
- Time constant
- Sensitivity

The Noise represents a measured signal as a function of the heating rate, temperature, sample mass or something else what is the object of investigation. In practice is important signal-to-noise ratio as a measure of detectable signal. The repeatability is important quality criteria and it is defined as a degree of agreement between many measurements of the same kind, carried out with the same instrument. Disagreement between measurements are most often result of an errors, which will be discussed latter. The linearity describes the functional relation between the true value  $Y_{tr}$  and the measured signal  $Y_m$ . Functional relation is determined by calibration procedure. The time constant is a measure of inertia of a measuring system. It describes with what time- delay signal from sample will be registered in measuring system. The sensitivity represents relation between the changes of the measured quantity compared to a measured signal. It is given as a number and a ration of units (e.g. for TG is  $\mu\text{V}/\text{mg}$ ) [7].



### **2.2.3. Characterization, interpretation and presentation of results**

Measured curve is a graphical way to represent the results of a thermoanalytical investigation. A curve provides information about property, or change of property of the sample depending on temperature or time. Basic terms, which are used to describe the measuring curve are:

- Peak- section of the measured curve comprising ascending slope, maximum and descending slope, minimum
- Step- section of the measured curve comprising ascending slope and point of inflection, or descending slope and point of inflection within a specific time or temperature interval, due to reaction or transition in the sample
- Baseline- section of a measured curve outside a peak or a step without underlying reaction or transition in the sample
- Plateau- section of a measured curve with constant or almost constant measured signal
- Initial baseline- section of a measured curve before peak or a step, in which reaction still did not take place
- Final baseline- section of a measured curve beyond a peak or a step in which a further reaction or transition in the sample does not take place [7]

Before using or publishing the results of thermoanalytical procedure, the values must be verified as being reliable. In order to achieve that, not only characterization of an instrument is enough but also some other criteria must be satisfied. The accuracy is criteria, which provides information how precise the results approximate the true value of a quantity. Influence on the accuracy has random and systematic errors. Known errors are characterized as systematic errors and corrections for them are taken into consideration. Random errors are unknown errors and they are estimated using the standard deviation. Second criteria which must be satisfied is a total uncertainty of measurement. This criterion indicates a range of values in which the true value lies. A final criterion is reproducibility, which provides information of a degree of agreement between the measured values using same kind of a sample but different instrument. These criteria may be used for detecting systematic errors.

Presentation of results should consist of following information:

- Characterization of the sample
- Characterization of the measuring instrument
- Calibration procedure
- Measuring procedure

- Original measurement curve
- Evaluation procedure for the measured values
- Uncertainty of the measurement results
- Interpretation and its verification

Values of a quantity must be expressed in International System of Units (SI) or SI-derived units. In the following Figure 7, an example of the measured curves is presented [7].

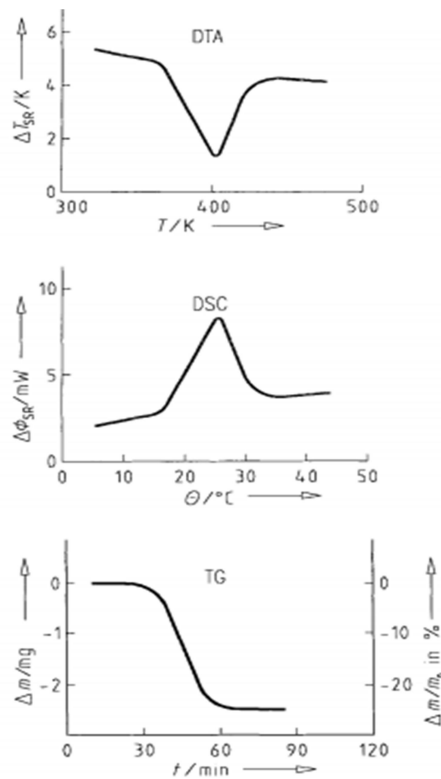

Figure 7- Examples of the measured curves [7]

### 2.3. Thermogravimetry (TG)

Thermogravimetric analysis (TGA) or simply thermogravimetry (TG) is a technique in which the mass of a substance is monitored as a function of temperature or time, as the sample specimen is subjected to a controlled temperature program in a controlled atmosphere. The samples which are submitted to this method are solids or low volatility liquids. Controlled atmosphere is achieved with sample purge gas, which flows over the sample. Purge gas can be inert or reactive. Mass is measured by thermobalance instrument, which has ability of simultaneous weighting and heating of a sample mass in a controlled atmosphere. Temperature range of a typical thermobalance device is from ambient temperature to 1000-

1600 °C. Results gained from TGA are represented as a thermogravimetric measured curves [7].

### 2.3.1. Fundamentals of Thermogravimetric analysis and kinetic mechanism

Thermogravimetry program can be isothermal or non-isothermal. Isothermal program represent the stepwise change from one to another temperature. Non-isothermal program most commonly consists of a linearly temperature change with time. This temperature change in thermogravimetry is known as a heating rate ( $\beta$ ).

$$\beta = \frac{dT}{dt} \quad (2)$$

The heating rate is commonly between 1-20 °C/min. Heating rate can vary, depending on program that is used in analysis. For example, heating program can consists of a heating from ambient temperature to 600 °C, at heating rate 10 °C/min or it can be combination of a several programs. This combination can be in example, heating from ambient temperature to 100 °C, at heating rate 100 °C/min, which is followed by isothermal hold at this temperature for 60 minutes and then again heating progress from 100 to 600 °C, at heating rate 10 °C/min [7].

Kinetic mechanism of process has a direct influence on a position of a curve. There are three major variables that determine the process: the temperature (T), the extant of conversion ( $\alpha$ ) and the pressure (P)

$$\frac{d\alpha}{dt} = k(T)f(\alpha)h(P) \quad (3)$$

Pressure is frequently ignored in the kinetics of thermogravimetry as a result of a high flow rates of inert gases during the experiment-  $h(P)=\text{const}$ . The extant of conversion depends on a reaction model of a process and it is determined experimentally. Value of the extant of conversion alters from 0 to 1 as a process proceeds.

$$\alpha = \frac{m_i - m}{m_i - m_f} \quad (4)$$

$m_i$  – initial mass

$m$  – current mass

$m_f$  – final mass

The temperature dependence of the process rate is defined through the Arrhenius law. The temperature of a process (T) is controlled by operator who set up the program.

$$k(T) = A \exp\left(\frac{-E}{RT}\right) \quad (5)$$

$A$  – the preexponential factor

$E$  – the activation energy

$R$  – the universal gas constant

Since the program can be isothermal or non-isothermal, measured thermogravimetric curves may also be isothermal or non-isothermal. Curves are represented in integral form of the reaction model and marked as  $g(\alpha)$ . Integral form is obtained by substitution of Arrhenius law into the equation of process rate. For isothermal curves, only changing variable in time ( $t$ ) is the extant constant  $\alpha$ , and the integral form of reaction model is:

$$g(\alpha) = \int_0^\alpha \frac{d\alpha}{f(\alpha)} = A \exp\left(\frac{-E}{RT}\right) t \quad (6)$$

The integral form of non-isothermal curve is obtained by substitution of Arrhenius law into the equation of process rate followed by integration of the linear heating rate equation, changing variables are temperature  $T$  and  $\alpha$ :

$$g(\alpha) = \frac{A}{\beta} \int_0^T \exp\left(\frac{-E}{RT}\right) dT \quad (7)$$

Mass loss during the isothermal program can occur in three different types: accelerating, decelerating and sigmoidal curve. Sigmoidal curve represents phenomena where mass loss rate passes through a maximum. Figure 8 presents mentioned types [31].

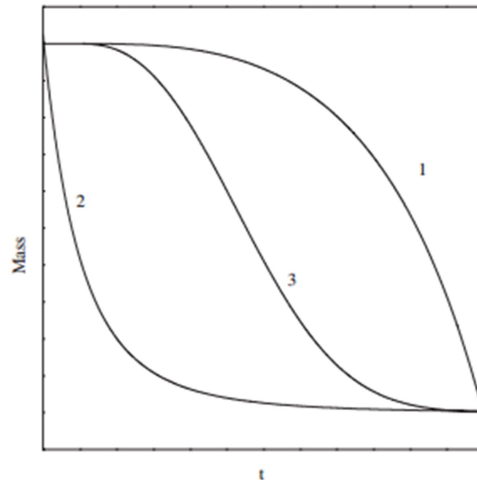

Three types of mass loss curves observed under isothermal conditions: 1. the mass loss rate continuously increasing; 2. the mass loss rate continuously decreasing; 3. the mass loss rate passes through a maximum.

Figure 8- Possible types of mass loss [31]

### 2.3.2. Thermobalance instrument

As was mentioned above, thermobalance instrument has a possibility of simultaneous heating the sample and weighting its mass. A thermobalance instrument consists of a balance mechanism and the furnace. Balance mechanism has installed sample holder and sample pan that helps to ensure stable process. There are four essential possible arrangements of thermobalance components and they are schematically presented in Figure 9.

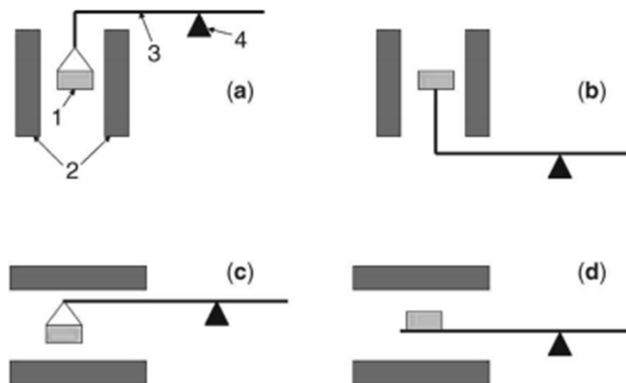

Schematic representation of major TGA arrangements: **(a)** Vertical suspended (1: sample holder; 2: furnace; 3: balance beam; 4: fulcrum); **(b)** Vertical supported; **(c)** Horizontal suspended; **(d)** Horizontal supported.

Figure 9- Schematic representation of TGA arrangements [31]

### 2.3.3. Temperature control

Providing heat to the furnace is important step to successful experiment and it is most difficult aspect of TGA. For a successful satisfying these criteria, three primary aspects must be fulfilled:

- Ensure a heat exchange with the sample
- The method of determine the temperature at the critical point
- The link between these two previous considerations

The temperature of a surrounding controls the temperature of the sample and it must not interfere with the sample mass measurement. Thermal transport can be via conduction through atmosphere or a direct radiation throughout the atmosphere.

Convective (resistive) thermal transport is achieved by the resistive elements of a furnace, which are carefully coupled, and their task is to raise the temperature of the furnace surface that is exposed to the sample and its environment. Thermal transport directly depends on the surface temperature and transparency as well as a thermal conductivity of the intervening medium. Furnace surrounds the sample in the symmetrical fashion and it is larger than it. The sample is positioned in the sample pan or tube and the controlled atmosphere flows through it. Gas phase flows need to ensure uniform heating. As was mentioned, resistive elements are key for successful thermal transport and they may be flexible or inflexible. Flexible elements are wrapped or in form of the wire and positioned directly on the atmosphere containment tube. Inflexible elements are in form of rods and symmetrically arranged around the atmosphere control tube.

Radiative (IR heating) is a method used to achieve higher temperature when rapid heating needs to be provided. Thermal transport is instantaneous, provided by a carefully focused halogen lamps or Infrared (IR) heaters. The optical path of an atmosphere along with absorbency of the sample and its container implicate an absolute heat flux. Reflectors may be shaped parabolically or elliptically and their focus may be a point, a line or a surface which is centered on the sample or its holder. Since the radiation depends on a transparency, to avoid dissipation of a heat, gas containment tube needs to be transparent. Their surface must be clean in order to prevent altered radiation. Measuring a temperature is challenging for this kind of a thermal transport since the heating is at higher rate. Possible arrangement of a focus and maximum temperature is presented in Figure 10 [7].



Parabolic reflector RHL-P			Elliptical reflector RHL-E		
Tubular focusing	Tubular focusing	Planar focusing	Tubular focusing	Tubular focusing	Linear focusing
1300°C	1300°C	1200°C	1500°C	1300°C	
					

Figure 10- Possible arrangement of a focus for radiative heating [7]

Even though the focus of TGA is on a mass changes, measuring and controlling the temperature is important part of a process. Knowing the heating rate and the sample temperature during the process opens the ability of a qualitative presentation and interpretation of results. Temperature has to be measured according to a norm ITS-90. Due to the norm, temperature may be measured via gas thermometers, platinum resistance thermometers, thermocouples, etc. Thermocouples are most commonly used sensors, which measures the signal in  $\mu\text{V}$ , which is then converted to temperature using the standard tables.

Important parameter of the thermocouples is their diameter of the wire. Larger diameters ensure longer lifetime and mechanical strength, but also increase thermal resistance. Higher thermal resistance will led to longer response time and it will increase thermal losses.

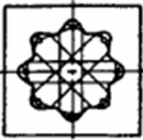
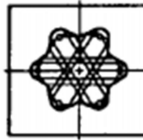
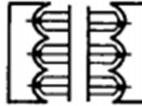
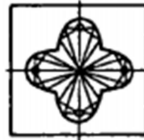
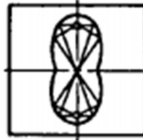
Direct contact between the sensors and the sample should be avoided. Indirect measuring technique such as by optical means, will measure only the temperature where the focus is set. Therefore, separate sensors should be used for the control of the heating profile and for the sample temperature measurement. Temperature control on a heating element will provide stability of the environment and response to changes in power supply will be quicker. On the other side, changes of enthalpy and heat capacity are ignored in this case. If the uniform heating zone is established, measurement of the temperature is easier.

Since the thermocouples are made of metals, thermal expansion must be considered during their positioning. Contact between thermocouples and the sample must be avoided, therefore solution is to bend them of the vertical axis and around the side of the pan. Even though, horizontal positioning is possible but some shielding effects or similar should be used then. Figure 11 presents some possible arrangements of the thermocouples [7] [31].

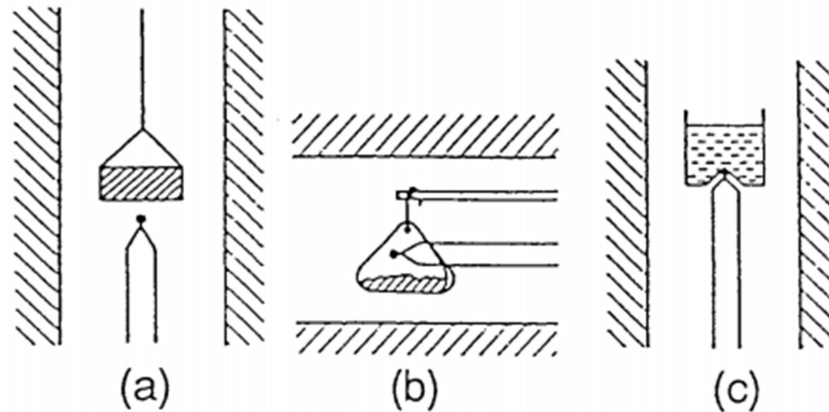

**Figure 11- Possible arrangements of the thermocouples [7]**

Once the measurement instruments are set down and procedure is about to begin, controlling the temperature during operation is vital for desirable outcome as well as to detect possible malfunctions in operation. There are two different methods for temperature control, one is conventional temperature control, and other method is control by change in mass.

Conventional control of temperature during the process is based on comparison between predetermined time-temperature profile and the temperature gained from the measuring sensors. A minimum difference between those two parameters is crucial for power supply to furnace. Power supply is determined by this minimum difference in a way to maintain this minimum. In example, if proscribed difference is decreasing below this minimum, power supply should be increased. To avoid exaggerated power consumption when a sensor is malfunctioning and to avoid thermal runaway, several techniques are developed. Most commonly used technique is when a break-up in thermocouple circuit is detected; temperature reading is set to maximum temperature. To ensure better control, more than one thermocouple should be used during the process. First thermocouple should be positioned in a way to provide best conditions for the sample measurement temperature. Therefore, second one may be positioned at central location near furnace winding. Consequently, response time is reduced and operating the temperature program is more easily. Even though there are two types of a temperature program (isothermal and non-isothermal), most commonly combination of these two types is used. Two types of a controller exist; temperature controller and programmer controller. Temperature controller provides isothermal control, thus programmer controller allows variation of the temperature at the time. Controller is in charge of maintaining the difference between desired and



measured values. Signal is used for control purposes and it is in a range from 4 to 20 mA. If the signal is 4 mA, there is no current to furnace, and if it is at 20 mA, furnace is operating at full power. Different control functions exist in order to provide the best possible control. Simple “on-off” regulation should be avoided because it is not sufficient for smooth control. Control system can be operated manually or adjusted computational.

Control by change in mass or Controlled rate thermal analysis (CRTA) does not use predetermined settings, but presents the changes in property. For TGA property of focus is mass as a function of time or temperature. Basic concept of CRTA is presented in Figure 12, and it is applicable to all techniques. Feedback loop can operate in three different modes.

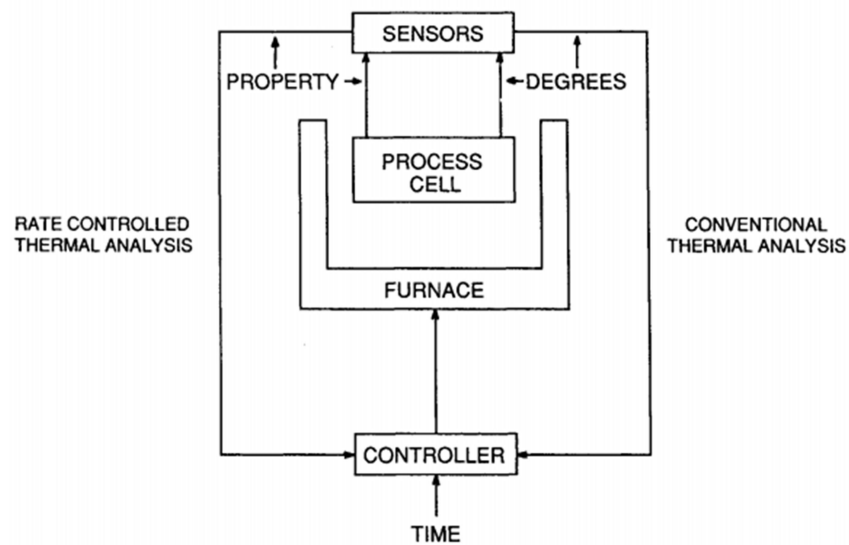

Figure 12- Basic concept of CRTA [7]

First mode prescribe a rate of mass loss in some form (mg/min, %/h) and then uses difference between input signal which is programmed rate of loss compared to observed rate of loss. If the mass loss is under prescribed rate, current to furnace is increased. During the oxidation process if mass gain is over the prescribed rate, current to furnace is decreased. Second mode prescribe the minimum rate of the mass loss and if the value is under this rate, linear heating is applied until rate of the mass loss exceeds an upper prescribed rate, which is commonly 100 higher than minimum rate. When this is achieved, temperature is held constant until the mass loss rate is settled again on minimum rate. Third mode is similar to second one with the difference that there is no isothermal hold, but reduction in the heating rate is applied. This mode is known as high resolution or Hi-Res TG [7].

#### 2.3.4. Atmosphere control

To perform a successful experiment, essential tool is a control of the atmosphere to which sample is subjected. Control of the atmosphere means control of the environmental conditions inside the furnace and control of the gas effects on thermobalance device components. Considerations that are taken into account during the selection of a gas are: cost, availability, purity, density and thermal conductivity. Atmosphere gas can be inert or reactive. Most commonly used inert or purge gas are helium, nitrogen or argon. Generally, noble gases are desirable in use for their purity and ability to clean the gas stream from oxygen and oxidizing molecules on elevated temperature. Devices used for measuring and control of the flow rate are:

- Conventional float and tube
- Simple liquid bubble tower
- Soap film bubble tower

Float and tube are used in very wide range of flow rates. Both of the bubble towers devices measure volume directly, so they require additional instruments for time measure, which is then converted into flowing rates. Another requirement for measure device is ability to switch from inert to oxidizing atmosphere as well as ability to switch flow rates easily. Pressure regulators and assumption of the unchanging drop in pressure in transmission line control flow rate. To ensure stability in flow rate, various type of diffusive disk (glass, ceramic, porous metal) is used.

Gas is usually controlled either on inlet or on outlet of the system. Incoming gas is control for its oxygen content, while exhaust gas is important for check of leaks in the system. All kinds of control must be mentioned in the result presentation because they may influence temperature or mass measurement. Gas should be preheated close to the sample temperature, before being exposed to it.

Sweeping volatile products and avoiding reverse reaction in the sample environment is achieved by directly percolation of the atmosphere over the powdered sample. Resulting forces of the gas stream may lower the observed mass even when there is no mass loss. Therefore, investigation in fluidization forces should be taken into consideration in order to prevent these phenomena.

In the occasions when information about the decomposition of the substance in its own gaseous products is needed, special design of the sample holders is used. Those types of sample holders have ability to establish “self-generated atmosphere”. Original atmosphere is

soon displaced with “self-generated” one because of existence of restricted path, which blocks the escaping gases.

Reactive gases or any other volatile products may influence the operability of balance mechanism inside the thermobalance devices. Most efficient way of protecting from these problems is to pass an inert purge gas through the balance chamber where reactive and inert gas will be mixed. This mixture can interact with the sample without any consequence. There are also other techniques of protection, depending on desirable conditions of the experimental study.

Most experiments are carried out on atmospheric pressure. Even though, sometimes is needed to perform study on a non-atmospheric pressure, most commonly on reduced pressure. Operating on a reduced pressure requires a careful approach, particularly in field of preventing leakages in system, exaggerated outgassing of the components, etc. Operating at higher pressure enables investigation of combustion processes, phase transformation and structures [7].

### **2.3.5. Sample considerations**

Important property of the sample is size and homogeneity. Size depends on the nature of the material and the object of an experiment. Before performing the analysis, representative sample or numerous of non-representative sample (average value) are taken into consideration to determine the level of homogeneity. Capacity of the balance determines the sample size. The sample is placed on an open pan where interaction with environment is enabled. Effects of the interaction between sample surface and the gas stream can be:

1. Reversible reactions
2. Reactions in which volatiles products react with gas s streams in exothermic manner
3. Chemisorption or physisorption
4. Those reactions where supply of an active component in the gas stream may be restricted

Static electricity can cause measurement errors of the mass or cause cling to the chamber wall. It is solved with inducing ionization in the gas phase or some other methods like conducting mesh or film on surface. Into the sample considerations must be taken possibility of creeping of liquid samples. The sample can also melt and flow out of the container, which can cause reaction with less corrosive resistant part. Also the decrepitating of solids can cause the sample pop out of the container and get lost. It is prevented with usage of mesh, which covers the sample.

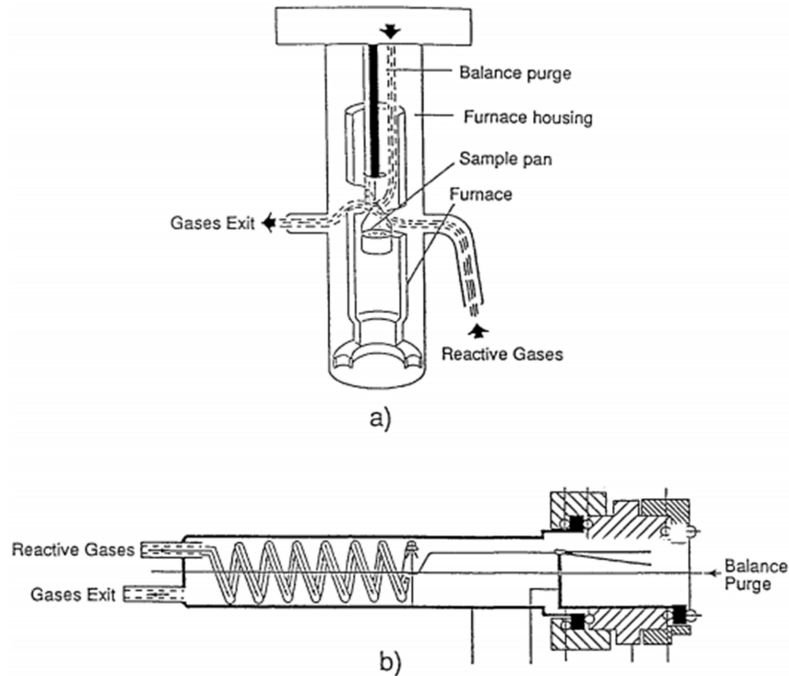

Figure 13- Vertical and horizontal arrangement of thermobalance device [8]

### 2.3.6. Sources of the error and instrument calibration

Temperature errors may be divided into the errors related to the sensors, errors related to a rate of heating and errors related to the heat of reaction. As was mentioned above, most common sensors used in TGA are thermocouples. There are three possible errors related to the thermocouples: their placement, their composition and the measuring circuitry. Placement of the thermocouples was discussed above. Errors related to their composition are the problem of the strains in the material. If the construction of the thermocouple is correct, strains will disappear after first few cycles. Problems in the measuring circuitry are not common in modern instrument so it will not be discussed here.

Errors related to the heating rate are matter of the thermal lag between the sensor and the sample. Depending on the position of the sensor compared to the sample, thermal lag can be greater or lower. Thermal lag can be in both directions. It is not possible to avoid this kind of errors. Increasing of the heating rate will lead to an increase of the errors. Difference between actual and measured temperature can be minimized if the slower heating rates and smaller samples are used.

Errors related to atmosphere are the problem of the buoyancy effects. Purge gases have different density at room temperature, and the difference is getting bigger as the temperature rises.

Critical measurements in TGA are mass, temperature and time, therefore they demand calibration to provide an accurate data. Results of the experiment demand precision (reproducibility) and accuracy (the true value). Reproducibility depends on homogeneity of the sample, instrumentation and ability to provide same environmental conditions. Accuracy depends on good precision and systematic errors. Systematic errors need to be solved with calibration and they are related to the constant offset in the measuring procedure.

Mass depends on a local gravitational force and buoyant force. Consequently, standard masses needs to be calibrated at different altitudes and latitudes. Changes in a mass after calibration are small, but the balance mechanism and the noise in the resulting curve may be significant. Calibration standards and procedure may be obtained from national standards or given by the commercial suppliers. There is several class of calibration procedure. Symbol M is used for lower class, while symbol S is higher class. Every class has relaxed tolerance for calibration. Calibration should be performed at room temperature, otherwise, changes in buoyancy and aerodynamic forces may disturb the process. When the calibration of dual system is performed, tare and the sample should not be treated the same at the atmospheric conditions. At the higher temperature, it is possible to account for the rate of change in the mass due to phase change of the sample (e.g. vaporization, sublimation).

Calibration of the temperature is performed by the International temperature scale following to melting point of selected pure metals. Currently calibration techniques that are used for TGA are “fusible link” and “magnetic standard”. Fusible link has been developed by McGhie et all [32]. Thin wire of the pure metal is suspended from the sample support system in close position to the sample. As the temperature raise, link is melted and drops from support. Weight will then be lost as abrupt weight loss or it falls on a sample pan which then cause the noise in mass signal so it is possible to recognize temperature and correlate it to “apparent” temperature determine by conventional sensor.

Magnetic standard is mostly used for Thermomechanical analysis and it is based on Curie temperature, so it will not be discussed in detail here [7].

### **2.3.7. Characterization, interpretation and presentation of results**

Results of TGA are occasionally presented in a graphical way. Since the TGA is based on observation of a mass change, most common as the abscissa is plotted mass or mass percent versus temperature or time as the ordinate. This type of graphical presentation is called thermogravimetric curve (TG curve). There is possibilities that time is plotted as abscissa and the temperature as the ordinate. This provides an acknowledgement of temperature program

that was used during experiment but it may complicate comparison between temperature and mass change.

Derivative thermogravimetry (DTG) is another possible way of presenting results. DTG curve provides information about rate of mass change as a function of temperature or time. Points of inflection in TG curves represent minima or maxima in DTG curves. Generally, information obtained from DTG curve reflects the reaction mechanism or changes in it during the experiment. In addition, DTG curves can be used for comparison with other differential technique (DTA, DSC, EGA, etc.) [7].

The integral form of curve (TG curve) presents change of mass plotted against temperature or time. Change of mass can be represents in absolute form or in the relative % compared to the initial mass. The differential thermogravimetric curve (DTG) provides information about peaks loss or gain in mass. Figure 14, presents an example of TG and DTG curves of some polymer material.

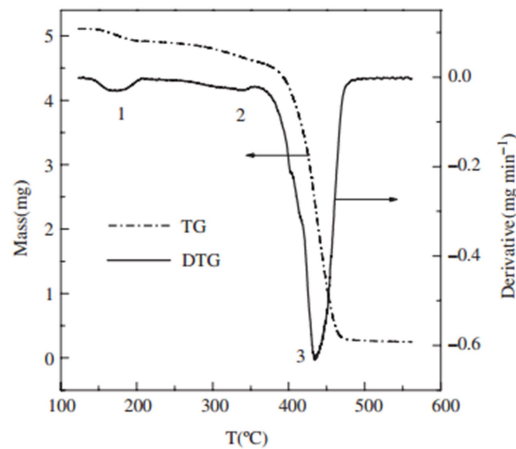

**Figure 14- Example of TG and DTG curves for some polymer material [31]**

The resolution of curves depends on heating rate or experimental time. If the heating rate is lower or experimental time is longer, the resolution of curve will be better [31].

Data acquisition can be analog or digital. Nowadays, digital data acquisition and handling is common way in practice. Modern instrumentation has ease and fastens up the whole procedure. Even though analog based instruments are still in use, especially when there is no possibility of an upgrade or funds to buy modern one. Such devices are much slower and less flexible so their application is very limited. Another limitation related to analog instruments is data output. Chart recorder, which is used, demands a lot of space for data storage and errors related to the plotting procedure may be occasional.

Use of a digital data acquisition expands the research capacity, followed by better control and flexibility of a process. Biggest advantage is for sure, time savings. There are few possible methods (Table 2) for controlling the number and the quality of results. Most common, method is determined by the manufacturer.

**Table 2- Methods of data acquisition [7]**

<b>Intended mode</b>	<b>Methodology</b>	<b>Comments</b>
Take points at present fixed intervals-constant $\Delta t$	Record a single sample and delay until the next preset interval	Easiest and least demanding of the data system
Take points continuously and average over a preset interval- constant $\Delta t$	Sum the points during the interval and divide by the number of points, essentially integrate	More demanding of system, but much improved signal to noise
Take points at preset increments of $\Delta m$	Wait for the next value of $m + \Delta m$ and record	Takes only the relevant points, when $m$ changes
CRTA based on $dm/dt$ or $dm/dT$	Any of the above	Control by feedback

Another advantage of digital data acquisition is opportunity of the data portability between different software programs. If the operator is not completely familiar with software package of the instrument, it can easily transport it to another software or computer via portable storage or network. For successful data acquisition and more important, their correctness, crucial is the experimentalist experience and his knowledge of a procedure, which will ensure the correct input data. Software cannot solve errors if the input is incorrect [7].

Automation of the process is very important in industry as well in academic society. It saves a time and provides opportunity of running multiple samples investigation in time. This may provide investigation of different samples and multiple specimens per furnace under the same condition. This is achieved by mechanical carousel and sample harness. Sample is selected, submitted to controlled furnace environment, weigh it over a preset time and then procedure is continued on the next sample. The samples are run sequentially and the environment conditions can be programmed for each sample individually or for the whole carousel. Even though that the experiment is automatized, the operator is still in charge of the experiment since he determine the temperature program and environment conditions [7].

#### **2.4. Gas chromatography-Mass spectrometry (GC-MS)**

As was mentioned in Introduction section, to obtain quality results of some thermal analysis, TGA method should be combined with some other methods. Gases which are the products of the TGA are used as the base for further procedure. Applying the coupled Gas chromatography-Mass spectrometry methods on evolved gases, it is possible to obtain information about structure of the sample, element abundance in the structure, etc. Therefore, each method will be presented in this section separately.

Gas chromatography (GC) is one of the fundamental technique in science to determine how many components and in which proportion they existed in a gas mixture. However, to understand chemical structure and nature of each component, it has to be used alongside with some spectrometric techniques. Most commonly it is used coupled with mass spectrometry (MS).

Gas chromatography is used for separating volatile and semi-volatile components based on the differences in their distribution. Gas mixtures contains of mobile and stationary phase. Stationary phase is based on some inner coating fuse of the column and a mobile phase is based on purge gas flow. Gas components with higher affinity to mobile phase will be rapidly carried out in a flow of purge gas. Otherwise, gas components with low affinity to mobile phase will be carried out with some time delay, which is called “retention time”. Mass spectrometry is used at the end of GC separation column for detecting the time distribution of the components in the purge gas flow.

The instrumentation for GC-MS analysis consists of two blocks, one is gas chromatograph and the other one is mass spectrometer. Figure 15 presents possible arrangement of such a system [9][33-34].



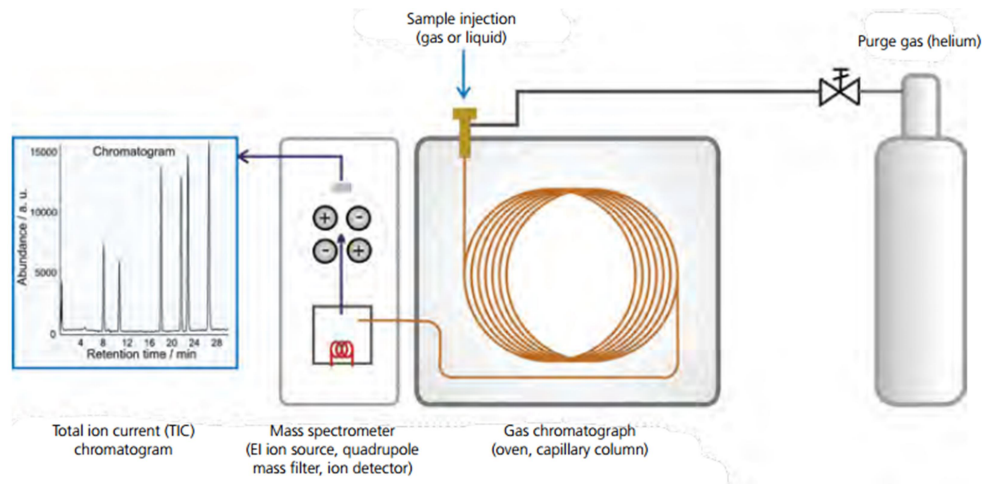

Figure 15- Schematic view of the coupled GC-MS instrumentation [9]

#### 2.4.1. Gas chromatography

Gas chromatograph is an instrument used for separating gas mixtures. That is achieved by using narrow flow-through tube, known as “column”. Column is most often in capillary form and gas stream flows through at different rates. Differences in rates depend on gas mixture components (chemical and physical properties) as well as the stationary phase of the column. Components will be separated and retained by the stationary phase of the column as the sample flows through length of the column. Stationary phase of the column is in form of microscopic layer of liquid or polymer on an inert solid support. When the component reaches to the end of the column it is detected and electronically identified. Mobile phase in GC is carrier gas, most usually some inert gas such as helium. Figure 16 presents schematic view of gas chromatograph and its components [35].

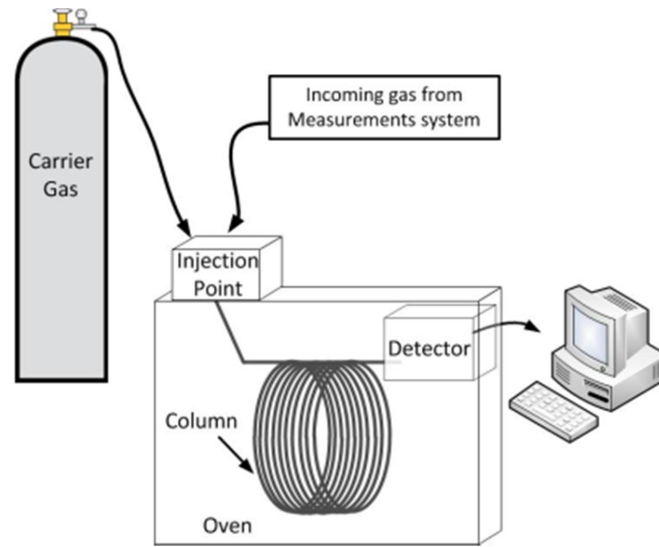

Figure 16- Gas chromatograph [36]

Sample for the GC must be volatilized and mixed with a stream of carrier gas (i.e. helium). Such mixtures enter the column in order to separate into different components. Injection of the sample into the GC column is crucial part of the procedure. Injection has to be continuously, rapid and in reproducible manner. Carrier gas has to satisfy two gas quality criteria. One is connected with continuous supply, and the other one is about gas purity (~99.9995% purity). There are three demands for efficient injection:

1. The sample must enter the column as thin as possible to avoid peak broadening
2. The percentage composition or relationship among the components of the mixture analyzed must be same before and after the injection
3. During their transfer to the column, components must not react with each other

Injection is nowadays mostly automatically via auto samplers. Injection ports and injection modes depend on numerous requirements and they are individual for almost every investigation. For example injection modes can be: split, splitless, on-column, program temperature vaporizer, etc. Most important requirements for choosing injection mode are:

- Volume of the sample to be injected
- The initial temperature of the column
- Injector temperature
- Requirements on septum

All mentioned requirements, alongside with speed of injection, reproducibility and injection efficiency has a direct impact on chromatographic peak [35].

Since the aim of GC procedure is to separate gas mixture into components, the chromatographic columns are as important as the injection part. Columns can be either packed or open tubular. Even though both of them can be used for same purpose and the same variety of investigations, open tubular or capillary columns are more popular since their higher separation efficiency. Selection of the column depends on the following parameters:

- Polarity of the mixture
- Length and Inner diameter of the column
- Phase thickness

Most of the samples consist of polar and nonpolar compounds, therefore there is no universal stationary phase. According to their length, columns can be: short (5-15 m), medium (20-30 m) and large (50-100 m). If the procedure is more complex, larger columns will be used. As the length of the column increase, pressure drop will increase and the heating rate of this column must be slower. Even though the higher sensitivity and resolution can be achieved with longer columns, their expenses and time of analysis can cause many problems. To overcome such problem, fast chromatography has been developed. Aim of this method is to reduce analysis time without losing resolution. That can be achieved by decreasing the inner diameter (ID) which standard dimension is between 0.25-0.32 mm. If the ID is reduced by half, the resolution increases fourfold. When decreasing the ID, pressure drop should be taken into account as well as the need for fast detection devices.

Since the column is contained into an oven, their temperature is important. The rate at which sample passes the column is directly proportional to the temperature of the column. The higher the temperature, the faster the sample moves. It should be noticed that the faster the sample moves, the less it interacts with the stationary phase, which can cause the lower level of separation [37].

#### **2.4.2. Mass spectrometry**

Mass spectrometry (MS) is analytical technique used for measuring the characteristics of molecules, converting them to ions and detecting them depending on their mass-to-charge ratio. Sample may be solid, liquid or gas in ionized form as a results of bombarding it with electrons. This cause breaking in sample's molecules into separated charged fragments. Such charged molecules can easily be detected by some mechanism (i.e. electron multiplier). Results are displayed as mass spectra as a function of the mass-to-charge ratio.

Mass spectrometer consists of three parts: an ion source, a mass analyzer and a detector. The ion source, or the ionizer, is the first part of mass spectrometer and it tasks is to

converts a fragment of sample into ions. Depending on the types of sample there are different techniques of ionization. For gases and vapors is used electron or chemical ionization. For ionization of solid and liquid samples it is used electrospray ionization or matrix-assisted laser desorption/ionization (MALDI). Every ionization techniques have advantages and disadvantages compared to another one. They should be selected according to desirable results and operating conditions. Also, ionization technique can be divided by degree of fragmentation and impart of residual energy. If the degree of fragmentation needs to be high, then hard ionization technique should be used (i.e. Electron ionization). Small degree of fragmentation will be achieved by soft ionization techniques (i.e. Chemical ionization). Higher the degree of fragmentation is needed; more residual energy will be imparted into subject molecule.

Mass analyzer separate ions according to their mass-to-charge ratio. Mass-to-charge ratio ( $m/Q$ ) is physical quantity for analysis and detection of charged particles, and unit is [kg/C]. It is based on Lorentz force law and Newton's second law of motion, and it can be expressed as:

$$\left(\frac{m}{Q}\right) a = E + v \times B \quad (9)$$

$m$  – mass

$Q$  – ion charge

$E$  – electric field

$v \times B$  – cross product of ion velocity and magnetic field

There are different types of mass analyzer but all of them operate on presented equation. Differences between them is based on are they operating on magnetic or electric field, and are they using dynamic or static field. Task of the mass analyzer is to separate and sort ions into beam according to their mass-to-charge ratio. If the all ions are charged under same condition their kinetic energies will be identical, therefore the velocity and time of reaching the detector depends only on their masses. Devices, which are used, for sorting the ions are called “Ion traps”. Nowadays, the most used is “Quadrapole mass filter”. Other possible solutions are: Three-dimensional quadrapole ion trap, Cylindrical ion trap, Linear ion trap, Orbitrap and Fourier transform ion cyclotron resonance. Basic of operation are similar to all of them, but their possibilities vary.

The last component of the mass spectrometer is the detector. The detector task is to record either the charge induced or the current produced when a charged ion hits a surface. They are measuring the signal and from that, the mass spectrum is created. Most commonly, some type of electron multiplier is used, even though some other devices can be used. Modern instruments are using Microchannel plate detectors [38][33-34].

As the mass spectrometer consists of three components, process of mass spectrometry also consists of three different steps. First, the ionizer is bombarding sample with electrons and they are then turned into positive ions, kations. After successful ionization process, such ions are accelerated towards other electrodes and inducted magnetic field. Magnetic field is the step where mass analyzer deflects the ion beam in arc whose radius is inversely proportional to the mass of each ion. Since that, not all ions are focused on same the level, only focused ion beam will pass the magnetic field and be detected. Varying the strength of the magnetic field, ions of different mass-to-charge ratio can be focused and pushed on a detector in different time. Ions are separated and sorted in the mass analyzer, depending on their mass and charge. Lighter ions are more deflected by magnetic field compared to the heavier one. Such sorted beams are pushed to the detector, which records the relative abundance of each type. Results are presented as chart and obtained information are used to determine the composition of the original sample. Figure 17 presents the schematic view of mass spectrometer and procedure of a process [8] [38].

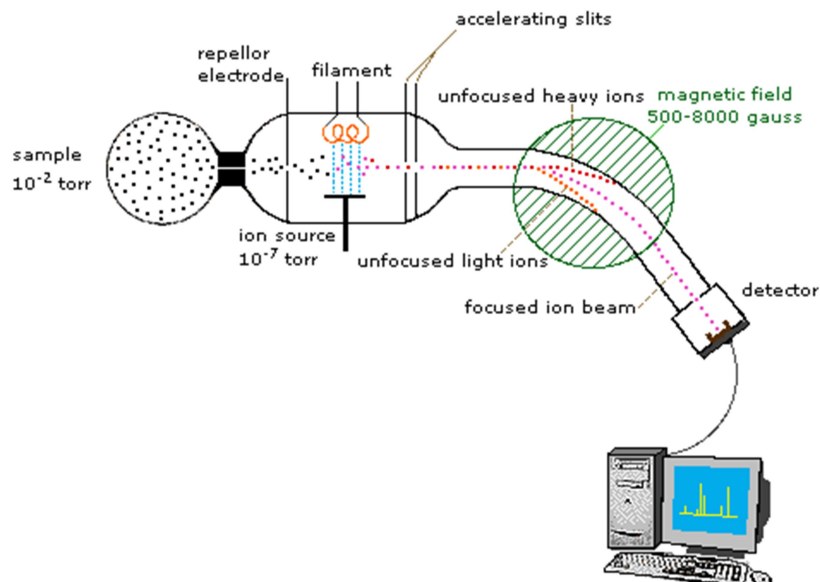

**Figure 17- Schematic view of mass spectrometer [38]**

### 2.4.3. Results acquisition and presentation

As was mentioned above, mass spectrum is most commonly used way of presenting the results. Also, the results can be presented as a chromatogram or three-dimensional contour map.

A mass spectrum is presented as a vertical bar chart where the x-axis presents a mass-to-charge ratio, and y-axis presents relative abundance of the ion in percentage (%). Scale of the y-axis is from 0 to 100, and the most intense ion is assigned with 100 and it is called the base peak. It is commonly used for protein characterization or pharmacokinetics studies.

A mass chromatogram presents the results as time (x-axis) versus intensity of the signal (y-axis). Even though that these type of presentation contains information about masses, problem may occur with visualization of this results. Therefore, such presentation is commonly used when MS is coupled with some other chromatography technique. In this case, y-axis still present total signal intensity, but x-axis presents retention time. Mass chromatogram may be presented as:

- Total ion current (TIC)- represents the summed intensity across the entire range of masses being detected at every point
- Base peak chromatogram- similar to TIC, but it monitors only the most intense in each spectrum
- Extracted-ion chromatogram (XIC)- analysts of interest are extracted from entire data set
- Selected-ion monitoring chromatogram (SIM)- similar to XIC, difference is that only a selected mass-to-charge ratio is detected
- Selected-reaction monitoring chromatogram [39]

Figure 18 presents an example of Total ion current chromatogram obtained from LC-MS analysis. From that example it may be noticed that at the beginning of the procedure, there is no element that leaves the mass spectrometer. As the process progress element abundance is reaching it peaks.

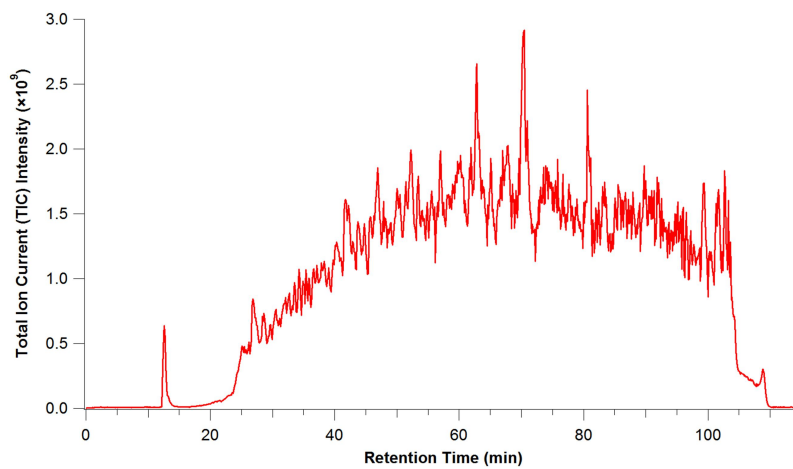

**Figure 18- Example of the Total ion current (TIC) curve [39]**

### 3. Sample preparation and identification

Investigated sample in this work was waste rigid polyurethane foam (WRPUF), which was acquired in milled form and formerly was used as an insulation material in a refrigerator. Sample was acquired with known Ultimate and Proximate Analysis results which are presented in Table 3.

**Table 3- Ultimate and proximate analysis of WRUF**

Sample	Ultimate analysis (wt. %)					Proximate analysis (wt. %)		
	$C_{ad}$	$H_{ad}$	$O_{ad}$	$N_{ad}$	$S_{ad}$	$V_{ad}$	$FC_{ad}$	$A_{ad}$
Polyurethane	62.69	6.32	24.01	6.37	0.63	83.2	10.6	6.2

The result of ultimate analysis shows that dominant element is carbon with 62.69%. Hydrogen and nitrogen are presented with share of 6.32% and 6.37%, as listed. Oxygen share is 24.01%, while sulphur is presented in traces 0.63%. Proximate analysis shows that this polyurethane foam has a big share of volatile matter with 83.2%, while fixed carbon is 10.6%. Share of ash is higher than expected with 6.2%. This results were compared with some previous research performed by Guo et al. [26] [27] and Wang et al. [40] and it can be noticed that proximate analysis shows almost the same share of volatile matters and fixed carbon in compared samples. High content of volatile matter is expected due to nature of polyurethane production. Ultimate analysis on the other hand, shows some differences in a share of detected elements. Compared to mentioned researches [26-27], share of carbon is around 4% lower, share of hydrogen is about 2% lower, while share of nitrogen is about 2% higher. Compared to Wang et al. [40], where only ultimate analysis was carried out, share of elements is almost exactly the same with difference in share of oxygen which is lower about 4%. High content of volatile matter, elemental carbon and hydrogen indicate that WRPUF is highly flammable and contain high calorific value, which support assumption that WRPUF has a high potential for energy recovery. Nevertheless, it must be noted that relatively high share of nitrogen will lead to formation of different nitrogen containing pollutants during pyrolysis or gasification process such as ammonia, hydrogen cyanide, etc.

#### 3.1. XRF spectrometry of WRPUF

Purpose of XRF spectrometry was to determine the trace element and macro elements of the sample, which cannot be identified by ultimate analysis. Even though results of ultimate analysis may determine the composition very well, it is necessary to mention, that the scope



of ultimate analysis is to determine the share of C, H, N, S and by the difference oxygen. Therefore, other elements which may be presented in a composition may be left unidentified, as well as their share. Since PUFs is produced with addition of blowing agents and some other additives which most occasionally consists of chlorine (Cl), XRF-spectroscopy need to be conducted in order to determine their share.

Before procedure, sample was divided into three fractions. One fraction consists of particles below 2 mm, second one consists of particle above 2 mm and the third one was mixture of first two. Portable XRF analyzer Innov-X DELTA Professional was used for XRF spectroscopy. Particular instrument has a range to measure elements from magnesium to uranium. Table 4 contains only elements with share more than 0.5% and those who may be hazardous, while altogether more than 20 elements were identified, mostly in traces.

Mixture		Fraction with particles above 2 mm		Fraction with particles below 2 mm	
LE	90,20%	LE	90,26%	LE	89,12%
Cl	3,68%	Cl	3,85%	Cl	4,00%
Fe	2,27%	Fe	1,67%	Fe	2,29%
Ti	1,33%	Ti	1,95%	Ti	1,42%
Zn	0,65%	Zn	0,42%	Zn	0,67%
Ca	0,59%	Ca	0,72%	Ca	0,60%
				Mg	0,88%
Pb	94 ppm	Pb	175 ppm	Pb	135 ppm
Hg	ND	Hg	ND	Hg	ND

**Table 4- Results of XRF spectrometry**

As it can be seen form the Table 4, around 90% share of composition has not been identified (light elements -LE). This is expected due to, as was mentioned in Chapter 2, XRF spectrometry does not cover or it is not useful to identify the element with atomic number less than 11 ( $Z < 11$ ). As well it was mentioned that instrument used in this procedure has a bottom of the range on magnesium, whose atomic number is 12. Since ultimate analysis shows us that around 76% of share are C, H and N, which all has  $Z < 11$ , high share of LE is expected. Identified element with biggest share is Cl with share from 3.68% (36 800 ppm) in mixture, up to 4% in fraction with particles below 2 mm. This amount of chlorine is way above allowed concentrations, which should not be more then 0.5% according to EURITS norm [41]. Only two elements whose share is above 1% in all fractions, are iron and titanium. Share of this two elements vary through fractions. Mixture and fraction with particles below

2 mm, shows correspondence in share of identified elements, while fraction with particles above 2 mm is a slightly different. Last two elements, which occur in all fractions with noticeable share are zinc and calcium, with their shares from 0.42% to 0.72%, depending on fraction. Also it is interesting to notice that magnesium is only element, including those in traces, which can be found only in one fraction. As it is visible from the Table 4, his share in fraction with particles below 2 mm, is 0.88%. This phenomena can be explained with the fact that magnesium can be grinded into really smooth powder, therefore, during the fraction separation and sieving, almost all of it ended up in this fraction, while his share in whole mixture is neglectable.

Highly toxic and hazardous compounds like mercury and lead are founded in small concentration. Mercury is not even detected, while lead is below allowed concentrations according to EURITS norm [41].

### 3.2. Particle sizing

Particle sizing is a method used to define the distribution of a particle sizes in a sample. Investigation was carried out with Malvern Mastersizer 2000, which has measurement range from 0.02-2000  $\mu\text{m}$  and capability to measure wet or dry samples. This method is used to determine the homogeneity of a sample, which may have a big repercussion on the final results. Conducted particle sizing on WRPUF sample, showed that investigated sample has a non-homogenous composition. This can be concluded from Figure 19, since homogenous sample should not have to peaks in a distribution curve.

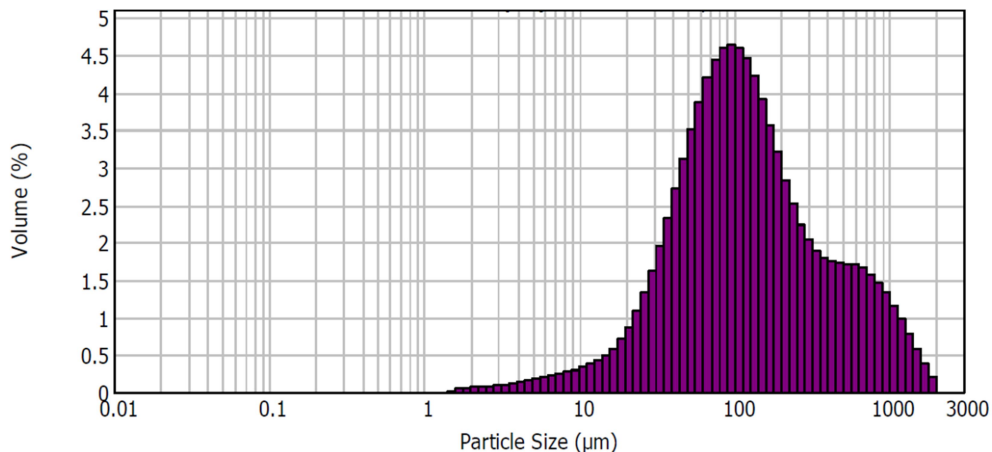

Figure 19- Distribution of particle size

Biggest peak occurred around 100  $\mu\text{m}$  with highest share of 4.65%. After 100  $\mu\text{m}$ , share is decreasing, up to the particle size 350  $\mu\text{m}$ , whereas share of particles with size from

350-800  $\mu\text{m}$  is remaining constant and it is about 1.70%. Lowest measured size was 1.500  $\mu\text{m}$ , while the biggest measured size was 2000  $\mu\text{m}$  with share of 0.21%. Detailed view on particle size distribution, alongside with their volume share is presented in Figure 20, which is obtained during the analysis.

Size ( $\mu\text{m}$ )	Vol Under %	Size ( $\mu\text{m}$ )	Vol Under %	Size ( $\mu\text{m}$ )	Vol Under %	Size ( $\mu\text{m}$ )	Vol Under %
1.002	0.00	7.096	1.59	50.238	20.39	355.656	81.16
1.125	0.00	7.962	1.84	56.368	23.91	399.052	82.95
1.262	0.00	8.934	2.11	63.246	27.78	447.744	84.70
1.416	0.00	10.024	2.41	70.963	31.97	502.377	86.43
1.589	0.02	11.247	2.75	79.621	36.41	563.677	88.14
1.783	0.07	12.619	3.12	89.337	41.01	632.456	89.84
2.000	0.13	14.159	3.55	100.237	45.66	709.627	91.50
2.244	0.20	15.887	4.05	112.468	50.27	796.214	93.09
2.518	0.28	17.825	4.65	126.191	54.73	893.367	94.57
2.825	0.37	20.000	5.37	141.589	58.95	1002.374	95.90
3.170	0.47	22.440	6.25	158.866	62.87	1124.683	97.07
3.557	0.57	25.179	7.33	178.250	66.44	1261.915	98.04
3.991	0.70	28.251	8.66	200.000	69.65	1415.892	98.82
4.477	0.84	31.698	10.28	224.404	72.49	1588.656	99.41
5.024	0.99	35.566	12.24	251.785	75.01	1782.502	99.79
5.637	1.17	39.905	14.56	282.508	77.25	2000.000	100.00
6.325	1.37	44.774	17.28	316.979	79.28		

Figure 20- Detailed view on particle size distribution

### 3.3. Sample homogenization and thermal analysis

In order to identify and quantify the compounds of WRPUF, analytical pyrolysis (Py) coupled with gas chromatography-mass spectrometry (GC-MS) was performed. As it can be seen in Chapter 3.2, sample was strongly non-homogenous. Therefore, division of a sample on a smaller fraction with homogenous structure was needed to obtain reliable results. Sample was conducted to Py-GC/MS as a non-homogenous mixture and fractions with:

- particles below 0.25 mm
- particles above 0.25 mm
- mixture of particles above and below 0.25 mm
- 8 fractions with different grain size presented in Table 5

**Table 5- Division on a fraction**

<b>Grain size class (mm)</b>	<b>Grain weight (g)</b>
Above 2.0	2.215
1.0-2.0	3.515
0.5-1.0	7.532
0.25-0.5	7.548
0.125-0.25	11.259
0.063-0.125	11.111
0.045-0.063	4.372
Below 0.045	0.028

Homogenization of the sample was made up by following procedure. From the 50 grams of non-homogenous mixture, with sieving, particles were divided as shown in Table 5. Since the weight share of particles below 0.25 mm is approximately 45% and weight share of particles above 0.25 mm is around 55%, this particle size was picked up as a referent border value for sample homogenization.

Determination of organic compounds present in waste rigid polyurethane foam was performed by method of pyrolytic gas chromatography with mass spectrometry detector (Py-GC/MS). The apparatus consists of pyrolysis unit Pyroprobe 5200 (CDS Analytical Inc.) connected by interface directly with gas chromatograph (HP Agilent 7890 A) and with mass spectrometric detector (5975 C). The samples of polyurethane foam (100–200 µg) were inserted into a pyrolytic quartz tube sealed at both ends by quartz wool. Internal standard (1 ng/µl of 1,3,5-tri-tert.-butylbenzene) was added to the sample for absolute quantification. The samples were analyzed by sequential pyrolysis at the temperatures 500, 600 and 700 °C, for the period of 10 s, the rate of temperature increase was 20 °C/ms. The interface between the pyrolysis unit and the gas chromatograph was heated to the temperature to 285 °C in order to avoid condensation of pyrolysis products. The pyrolysate was then separated by GC/MS at the non-polar column HP 5 ms (60 m x 250 µm x 0.25 µm). The temperature program was as follows: 40 °C (retention time 2 min), 40-220 °C (retention time 10 min.) with temperature ramp 10 °C/min, and 220-320 °C at 33 °C/min for 5 min. The temperature of the injector and transfer line were maintained at 290 °C and 285 °C. Samples were injected automatically by pyrolytic unit to inlet of chromatograph in split mode 1/100. The temperature of electron ionization and detector were maintained at 230 °C and 150 °C. Compound identification are based on comparisons with authentic standards (external), GC retention time, literature mass

spectra and interpretation of mass spectrometric fragmentation patterns. Mass spectrometer 5975 C (Agilent) operated at 70 eV with a mass detection range of  $m/z$  50-600. Compound quantification was performed using internal and external standards.

## 4. Results and discussion

### 4.1. Decomposition mechanism in oxidative and non-oxidative atmosphere

To determine the kinetic mechanism of decomposition, sample was conducted to pyrolysis under oxidative and non-oxidative atmosphere. Oxidative atmosphere was air, while non-oxidative was nitrogen. Previous investigations showed that decomposition in oxidative atmosphere occasionally has three steps, while in non-oxidative it has two steps [42].

Obtained results from this sample, showed the similar behavior. To obtain TG curves, sample was heated from room temperature 30 °C to 1000 °C, at heating rate 10 °C/min. Purge gas flow in both cases was 50 ml/min. In air atmosphere, sample was tested with two different initial masses. Firstly, 10 mg of sample was conducted to the analysis. As it can be seen from Figure 21, decomposition consists of three steps, and unburned mass at the end was less than 1 mg (10% of initial mass). During the decomposition significant amount of heat was released, due to exothermic nature of reaction.

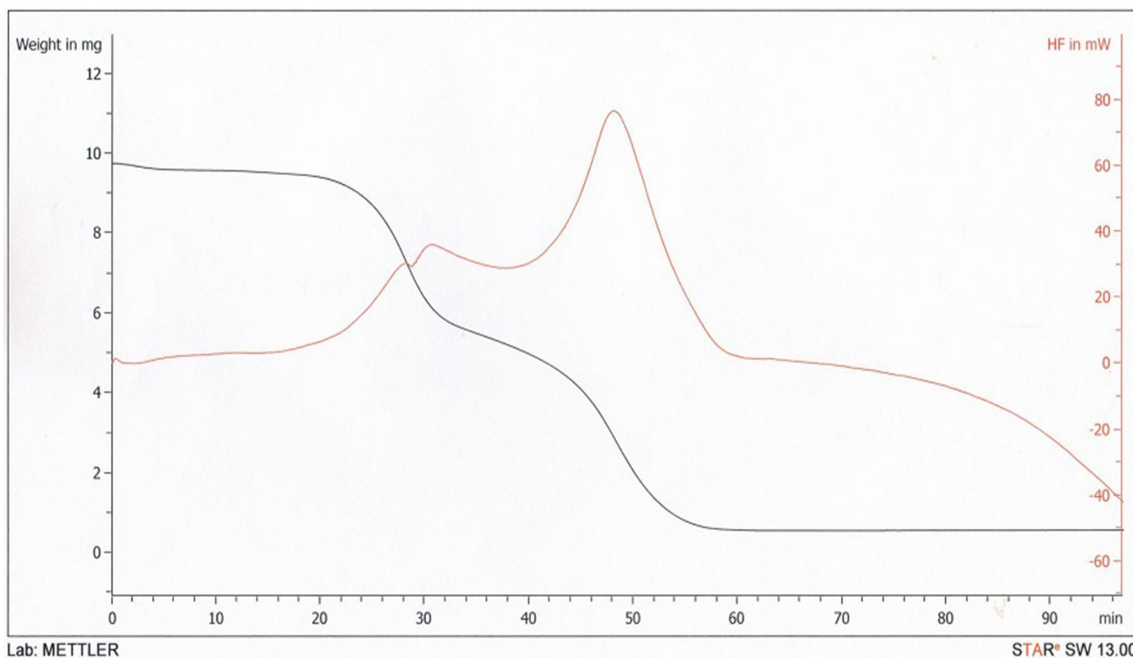
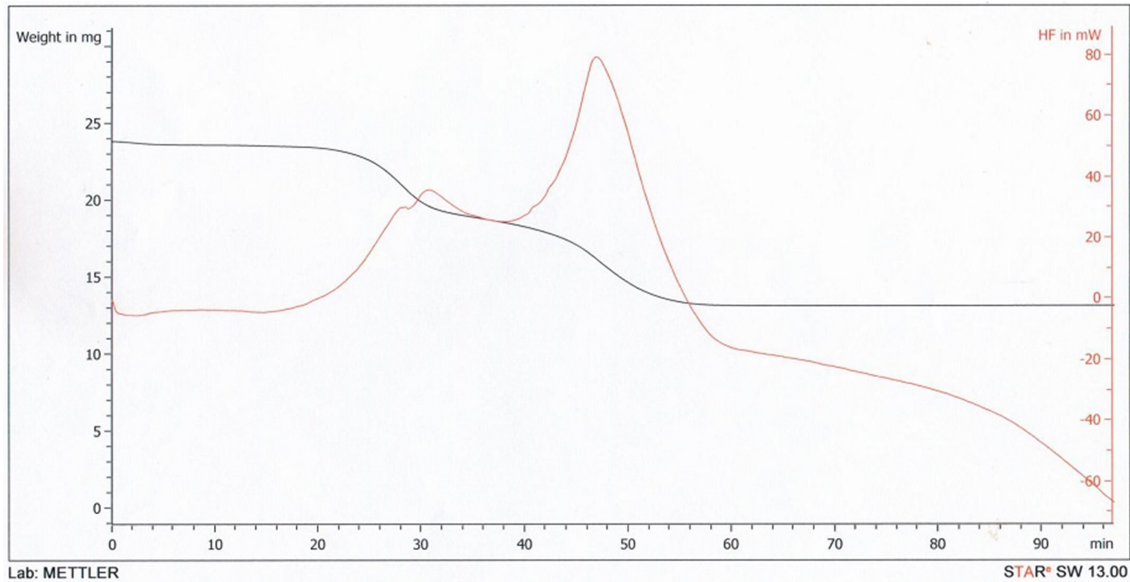

Figure 21- TG curve in Air atmosphere-initial mass 10 mg

Second analysis was also performed in air atmosphere, but now initial mass of a sample was 24 mg. Decomposition, once again, consists of three degradation steps. Unburned mass at the end of an investigation was 14 mg, which means that only 40% of a mass was

burned during decomposition (Figure 22). Since the former investigation (Figure 21), showed that 90% of an initial mass was burned, it is obvious that mass of a sample can significantly influence the decomposition process.



**Figure 22- TG curve in Air atmosphere- initial mass 24 mg**

Non-oxidative atmosphere was nitrogen and initial mass of a sample was 10 mg. Figure 23, presents decomposition process and it is visible that degradation mechanism consists of two steps. Final mass was 1 mg, which means that 90% of initial mass was decomposed. Comparing to oxidative atmosphere it can be seen that degradation in non-oxidative atmosphere is endothermic, which means that huge amount of heat need to be provided in order to achieve thermal degradation.

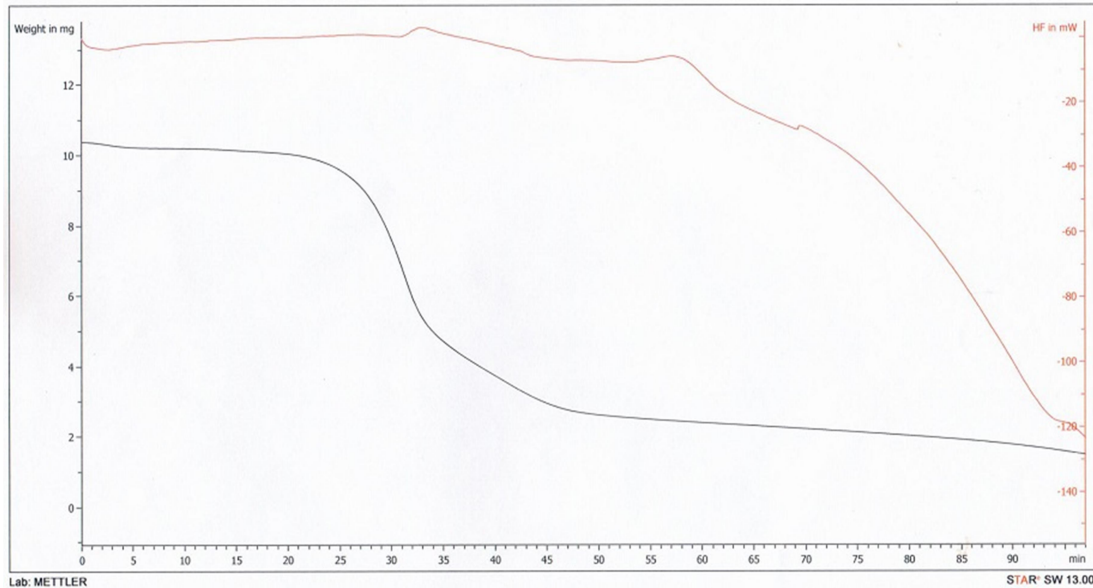

Figure 23- TG curve in Nitrogen atmosphere- initial mass 10 mg

## 4.2. Non-homogenous mixture

Non-homogenous mixture which was conducted to the investigation was randomly picked from WRPUF sample mixture. Chosen non-homogenous mixture was divided into three parts in order to perform pyrolysis on three different temperatures as was mentioned in previous chapter.

Various groups of organic compounds were founded in the sample. The most important compounds with the highest concentration share are compounds containing nitrogen, aromatic hydrocarbons, alcohols, alkanates, carboxylic acids and alkanes. Those compounds are founded in various concentrations depending on the pyrolysis temperature. Table 6 presents all identified organic compound groups with their corresponding share in ng/mg.



Table 6- Organic compounds groups founded in non-homogenized sample

Pyrolysis temperature	500 °C	600 °C	700 °C
<b>Organic compounds [ng/mg]</b>			
<i>Compounds containing nitrogen</i>	3 728	2 155	1 004
<i>Aromatic hydrocarbons</i>	970	2 348	333
<i>Alcohols</i>	839	1 506	486
<i>Alkanoates</i>	816	806	424
<i>Carboxylic acids</i>	463	307	398
<i>Alkanes</i>	417	621	212
<i>Alkenes</i>	173	175	108
<i>Alkadiens</i>	49	21	27
<i>Aldehydes</i>	330	198	181
<i>Furans</i>	58	38	36
<i>Nitriles</i>	31	5	15
<i>Compounds containing phenol</i>	4	16	143
<i>Heterocyclic acetyls</i>	78	71	37
<i>Oxiranes</i>	37	68	18
<i>Ethers</i>	206	211	294
<i>Acrylates</i>	1	3	6
<i>PAHs</i>	103	78	124
<i>Phthalates</i>	49	67	185
<i>Unknown</i>	115	48	370

As it can be seen from the Table 6, concentrations of various organic groups are strongly dependable on the pyrolysis temperature. At the pyrolysis temperature of 500 °C, dominant are compounds containing nitrogen with concentration of 44%, followed by aromatic hydrocarbons, alcohols and alkanoates. Those four groups remain dominant at the other pyrolysis temperatures, but with the different share. Organic compounds containing nitrogen are mostly amines and amides. Since the amines are used as catalyst for polyurethane foam production, significant presence was expected. Highest concentration had aniline with the share of 878 ng/mg. Aniline is highly toxic by inhalation of the vapor or ingestion and its concentration founded on 500 °C is much higher than it is recommended by NIOSH<sup>1</sup>. Compounds with significant yield on first pyrolysis temperature are also n,n-dimethylmethanamine, n,n-dimethylethanthioamide and n,n-dimethylbenzenemethanamine which are occasionally used as catalyst during foam production. Detected concentrations of those compounds raise concern since their high toxicity, especially is that noticeable for n,n-dimethylmethanamine at second pyrolysis temperature (815 ng/mg). Aromatic hydrocarbons have also been found in significant concentration during the procedure, especially styrene and toluene. On the other hand, benzene is founded in smaller concentration which are not

<sup>1</sup> NIOSH-National Institute for Occupational Safety and Health

exceeding allowed one or are potentially harmful for human health. At the 600 °C, concentration of the compounds containing nitrogen is decreasing, especially share of the aniline. Most dominant group at 600 °C is aromatic hydrocarbons, precisely toluene with concentration of 1894 ng/mg. This amount of toluene is strongly dangerous and harmful for human health and exposure to it should be avoided. Share of toluene is rapidly decreasing at the pyrolysis temperature 700 °C.

Pyrolysis temperature of 700 °C, intensively decrease the concentration of organic compounds. Concentration of organic compounds at this temperature is about 4 400 ng/mg, which is almost half of those founded at 500 °C (8 467 ng/mg) and 600 °C (8 740 ng/mg). Dominant group are once again compounds containing nitrogen, but now without one dominant compound, since the share of 1 000 ng/mg is divided between more than 40 different compounds which were founded. At that temperature it is noticeable that only Phenol had significant concentration increment, which was 134 ng/mg. Phenol is strongly toxic component, used as precursor for many polymer materials.

Table 7, presents detailed view on observed compounds founded during pyrolysis investigation. More than 250 organic compounds have been found, and here are listed those with higher yield or those who are classified as dangerous or toxic.

**Table 7- Concentration of various organic compounds**

<b>Pyrolysis temperature</b>	<b>500 °C</b>	<b>600 °C</b>	<b>700 °C</b>
<b>Organic compound [ng/mg]</b>			
<b>Aromatic Hydrocarbons</b>			
<i>benzene</i>	125.69	21.65	13.01
<i>styrene</i>	365.07	241.27	69.39
<i>toluene</i>	218.90	1893.63	27.99
<i>butylated hydroxytoluene</i>	19.77	56.91	30.75
<i>1,2-dichlorbenzene</i>	12.50	2.47	55.59
<b>Alkanes</b>			
<i>hexadecane</i>	42.37	57.53	42.18
<i>isocyanatocyclohexane</i>	34.60	41.45	14.98
<i>3-methyleneheptane</i>	50.13	79.80	27.99
<i>tetracosane</i>	13.42	59.39	9.46
<i>heneicosane</i>	19.07	38.97	9.86
<b>Aldehydes and ketones</b>			
<i>2,3-dihydro-1H-indol-1-carboxaldehyde</i>	194.89	20.41	8.56
<b>Compounds containing heterocyclic nitrogen</b>			
<i>aniline</i>	878.42	39.84	18.14
<i>2-chloro-n,n-dimethylethanamine</i>	150.40	109.00	83.97
<i>2-methyl-5-(1-methylethenyl)pyridine</i>	310.70	111.24	90.70
<i>2-methylquinazoline</i>	118.63	102.47	91.00

<i>n,n</i> -dimethylbenzenemethanamine	291.63	155.06	53.62
<i>n,n</i> -dimethylethanthioamide	456.16	15.52	25.63
<i>n,n</i> -dimethylmethylamine	456.16	814.74	11.83
<b>Furans</b>			
2,5-dimethylfuran	57.20	35.96	31.93
<b>Alcohols</b>			
1,1'-(1-methyl-1,2-ethanediyl)bis(oxy)bis-2-propanol	100.27	176.93	13.80
1-phenantrenol	35.30	515.32	43.40
2,3-dimethyl-2,3-butanediol	71.00	144.76	26.41
1,1'-oxybis-2-propanol	293.75	40.21	35.50
1-(1-methylethoxy)-2-propanol	89.68	24.75	50.07
1-(2-butoxy-1-methylethoxy)-2-propanol	58.61	11.14	3.15
<b>Carboxylic acids, anhydrides</b>			
methyl ester 2-chloropropanoic acid	80.50	34.64	4.34
3-fluorophenyl ester phenyl acetic acid	82.62	10.52	5.13
dimethyl ester propandioic acid	27.54	38.97	10.64
methyl ester cynohydroxyimino acetic acid	31.78	25.60	37.85
methyl ester carbamic acid	8.47	10.52	47.70
benzoic acid	6.36	1.55	4.73
bis(2-ethylhexyl) ester 1,3-benzenedicarboxylic acid	5.65	3.09	2.76
bis(2-ethylhexyl) ester 1,4-benzenedicarboxylic acid	3.53	4.05	4.73
<b>Alkanoates</b>			
2-methoxyethyl pentanoate	211.84	244.36	35.09
butyl 2,5,8,11,14,17,20-heptaoadocosan-22-oate	260.56	105.67	118.27
methyl 2,5,8,11,14-pentaoxahexadecan-16-oate	35.31	246.83	51.30
<b>PAHs</b>			
naphthalene	24.71	9.90	3.55
quinoline	31.07	25.63	25.91
benzo(a)pyrene	2.12	0.06	1.18
dibenzo(c,h)acridine	4.94	9.30	7.90
4-methylchinoline	1.41	1.90	10.64
1,2,3,4-tetrahydro-5-methylnaphthalene	9.89	6.85	7.88
benzo(b)fluoranthene	2.00	1.86	1.18
benzo(e)pyrene	3.53	1.61	1.58
benzo(j)fluoranthene	2.12	2.56	3.90
benzo(k)fluoranthene	2.52	0.62	3.15
<b>Phthalates</b>			
1-chloro-2-propanol phosphate (3:1)	10.22	8.52	68.99
benzyl butyl phthalate	7.06	8.52	9.86
dibutyl phthalate	8.47	3.78	4.73
bis(2-ethylhexyl)phthalate	4.24	15.26	41.00

Compounds which are detected in smaller concentrations, but for their nature special attention should be given, are polycyclic aromatic hydrocarbons (PAHs). Even though their share in overall yield is not exceeding 1%, their high toxicity calls for cautious approach. The quinoline is one, which is occurring in more-less same concentrations between 25-31 ppm at all three pyrolysis temperatures. Naphthalene, which is potentially carcinogen has a highest yield on 500 °C, while on the others temperature concentrations are significantly lower. Figure 24, presents the yield of detected PAHs during the procedure, altogether 20 PAHs have been founded. As it can be seen from the Figure 24, highest yield is obtained during the pyrolysis on the 700 °C. Even though the share of compounds is different, degradation behavior is similar as in the investigation carried out by Garrido et al. [43] on flexible polyurethane foam.

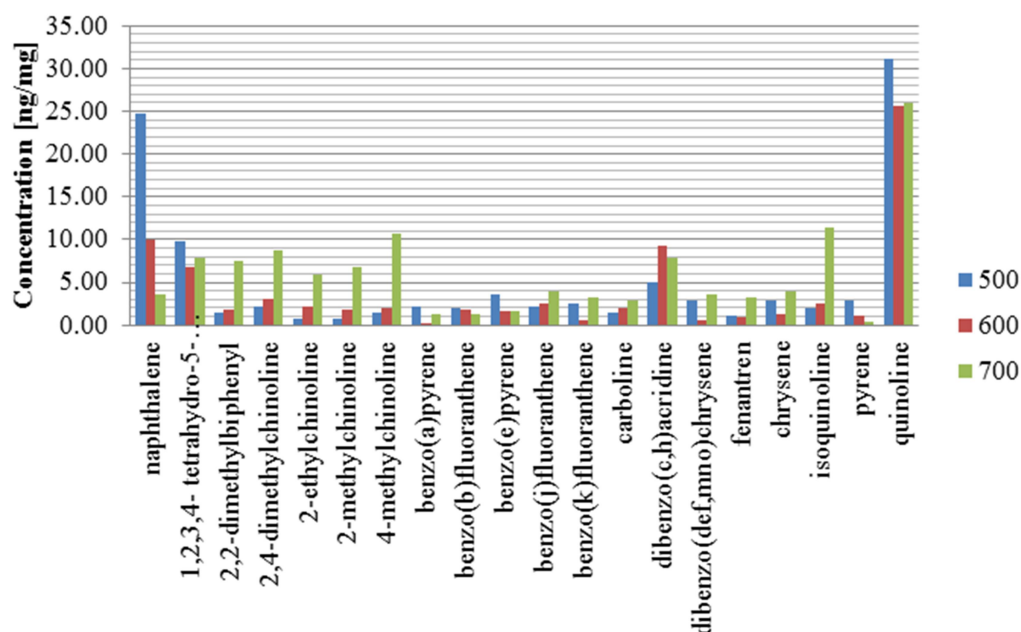

**Figure 24- Yield of PAHs**

Phthalates, whose share is less than 1% of concentration, are used a plasticizers for many polymeric products. Normal, daily exposure to phthalates is around 15 ppm, which only exceeds 1-chloro-2-propanol phosphate (3:1) and bis(2-ethylhexyl)phthalate at the pyrolysis temperature 700 °C. First one is used as a flame retardant and it concentration is not dangerous for human health. Phthalates have been controversial because of their impact on human health and many of them have already been banned from polymer production, including bis(2-ethylhexyl)phthalate [16]. In general, there have been a lot of identified

compounds containing chlorine. High share of chlorine was detected during XRF-spectroscopy, probably from isocyanates which are used for foam production. Therefore, various compounds containing chlorine was expected. Even though their share is not significantly high, special attention should be given for this kind of compounds since they have high ozone depletion potential. Furthermore, compounds containing chlorine and fluorine are strongly hazardous for waste-to-energy plants since they cause corrosion. Concentration share of compounds containing chlorine is highest at 700 °C and it is 0.05%. Yield of these compounds is decreasing as the temperature rises. All compounds containing chlorine are listed in Table 8.

**Table 8- Compounds containing Chlorine**

<b>Compounds containing Chlorine</b>	500	600	700
<i>1-chloro-4(chloromethyl)benzene</i>	0.71	3.71	7.49
<i>1,2-dichlorobenzene</i>	12.50	2.47	55.59
<i>1,1-dichloroethane</i>	5.65	26.60	25.23
<i>1-(2-butylamini)butyl)imino)-7-chloro-3-(2,4-dichlorophenyl)-1,3,4-10-tetrahydro-9-(2H)-acridinone</i>	3.01	25.36	8.28
<i>2-chloro-n,n-dimethylethanamine</i>	150.4	109.0	83.97
<i>3-chloro-2-fluoro-n-(3-chloro-2-fluorobenzoyl)-N-hexylbenzamide</i>	0.81	32.17	9.46
<i>3-chloro-2-fluoro-n-(3-methylbutyl)benzamide</i>	0.70	1.09	1.58
<i>3-chloro-2-methyl-2-pentanol</i>	0.71	2.85	5.13
<i>bis(1-chloro-2-propyl)(3-chloro-1-propyl)phosphate</i>	5.25	15.60	9.07
<i>4-chloro-1-ethyl-1H-pyrazole-3-carboxylic acid</i>	0.07	1.39	8.28
<i>methyl ester 2-chloropropanoic acid</i>	80.50	34.64	4.34
<b>Total</b>	<b>260.31</b>	<b>254.89</b>	<b>218.41</b>

Special attention was given for the yield of carcinogen compounds in the sample. In Table 9, are listed all possible compounds which are presenting the possible harm to human health or environment. Highest yield is noticed at the pyrolysis temperature 500 °C, where their share is around 14.7%. Overall yield of this kind of compounds is decreasing with the temperature increment, even though their share at 700 °C is still high, around 10%. Dominant compounds are those containing propanol. Alcohols are generally used as a solvent and they do not represent a danger for human health by itself, but they might be harmful with the combination of some methyl or ethyl groups. Biggest danger for health is representing compounds containing benzene, mostly PAHs [15]. Styrene, which is classified as potentially carcinogenic compound, has the highest yield through all temperatures.

Table 9- Compounds which are classified as carcinogen or potentially carcinogen

<b>Carcinogen compounds [ng/mg]</b>			
<b>Pyrolysis temperature [°C]</b>	<b>500</b>	<b>600</b>	<b>700</b>
<i>1,2-dichlorobenzene</i>	12.50	2.47	55.59
<i>Benzene</i>	125.69	21.65	13.01
<i>Styrene</i>	365.07	241.27	69.39
<i>Heneicosane</i>	19.07	38.97	9.86
<i>Isocyanatocyclohexane</i>	34.60	41.45	14.98
<i>3-chloro-2-fluoro-n-(3-chloro-2-fluorobenzoyl)-N-hexyl-benzamide</i>	0.81	32.17	9.46
<i>3-chloro-2-fluoro-n-(3-methylbutyl)benzamide</i>	0.70	1.09	1.58
<i>Benzonitril</i>	12.71	1.24	5.26
<i>2-methylbenzonitrile</i>	10.70	2.41	6.70
<i>2,6-dimethyl-4,4-tetramethylene-1,4-dihydroxypyridine-3,5-dicarbonitrile</i>	7.10	1.37	2.59
<i>1-(1-methylethoxy)-2-propanol</i>	89.68	24.75	50.07
<i>1-(2-butoxy-1-methylethoxy)-2-propanol</i>	58.61	11.14	3.15
<i>1,1'-(1-methyl-1,2-ethanediyl)bis(oxy)bis-2-propanol</i>	100.27	176.93	13.80
<i>1,1'-oxybis-2-propanol</i>	293.75	40.21	35.50
<i>benzoic acid</i>	6.36	1.55	4.73
<i>bis(2-ethylhexyl) ester 1,3-benzenedicarboxylic acid</i>	5.65	3.09	2.76
<i>bis(2-ethylhexyl) ester 1,4-benzenedicarboxylic acid</i>	3.53	4.05	4.73
<i>Naphthalene</i>	24.71	9.90	3.55
<i>Quinolone</i>	31.07	25.63	25.91
<i>7H-benz(de)anthracen-7-one</i>	0.89	0.68	2.37
<i>benzo(a)pyrene</i>	2.12	0.06	1.18
<i>benzo(b)fluoranthene</i>	2.00	1.86	1.18
<i>benzo(k)fluoranthene</i>	2.52	0.62	3.15
<i>Chrysene</i>	2.82	1.24	3.94
<i>bis(2-ethylhexyl)phthalate</i>	4.24	15.26	41.00
<i>benzyl butyl phthalate</i>	7.06	8.52	9.86
<i>dibutyl phthalate</i>	8.47	3.78	4.73
<i>1-chloro-2-propanol phosphate (3:1)</i>	10.22	8.52	68.99
<b>Total</b>	<b>1242.92</b>	<b>721.86</b>	<b>469.03</b>

Gaseous products which are collected during the experiment are presented in Figure 25. Dominant products are carbon dioxide (CO<sub>2</sub>) and nitrogen emissions (NO<sub>x</sub>) with biggest share at 500 °C (78%), while their yield is a significantly lower on other temperatures. Propylene and propylene oxide are gases with significant yield at all three temperatures. Propylene which is non-toxic, but strongly flammable has a highest yield of 12% at 500 °C, while his share is the lowest at 600 °C, with less than 5%. At the same time propylene oxide, which is listed as probable carcinogen, has the lowest yield at 500 °C with 5% share, while on 600 °C his yield is significant and presents 18% of overall gaseous products. Propylene is

used for making polyether polyols, therefore significant share of products containing it is expected. Ethylene oxide and cyclobutane are non-carcinogen gases with highest yield of 8% and 12.6% respectively, at 600 °C, while their share on another pyrolysis temperature is almost neglectable. Strongly hazardous substance as ammonia, does not have a significant yield and its share in gaseous products is around 1%.

Biggest consideration should be given to the yield of trichlorofluoromethane, known by its commercial name CFC-11. This substance is listed as strongly hazardous with high ozone depletion potential, therefore it has been banned from U.S. production in 1996 [44]. Share of this product is increasing as the temperature rises and at 700 °C it is 14.6%. This amount of share is of very high concern and necessitates precautions.

### Gaseous products

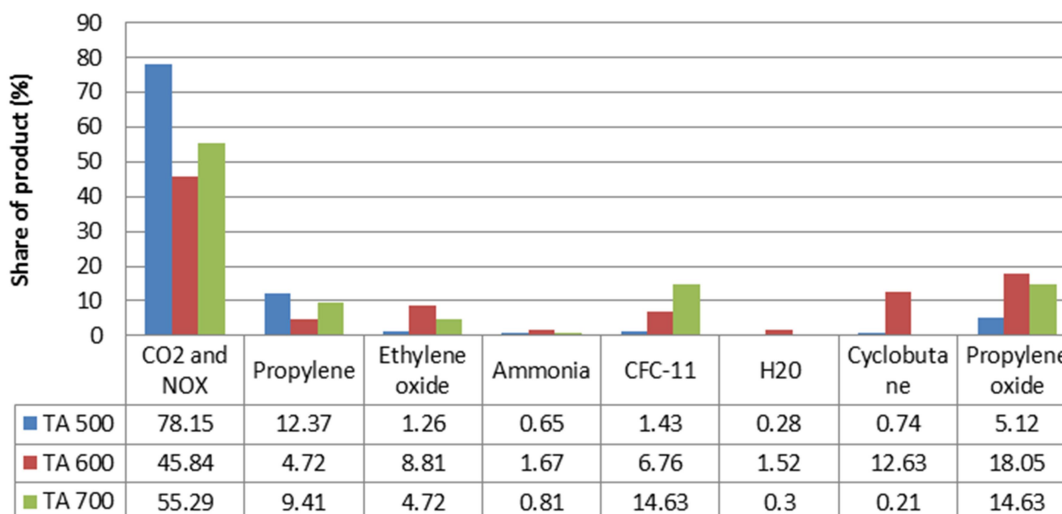

Figure 25- Yield of gaseous products

### 4.3. Homogenized sample

Analytical pyrolysis showed that decomposition of non-homogenous sample produces a wide spectrum of organic compounds with a significant share of hazardous one. Moreover, yield of organic compounds on different pyrolysis temperature was considerably different. Therefore, homogenization of the sample was needed to obtain reliable results, as well as to compare results between those investigations, especially the effect of a grain size on the yield of organic compounds and gases. Homogenization process is presented in Chapter 3, followed up by the Table 5 which reveals the particle sizes found in a sample. Analytical pyrolysis of homogenized sample was carried out under the same conditions as for non-homogenous

sample. There have been three different homogenized samples which were conducted to the pyrolysis, one fraction with the particles above 0.25 mm, fraction with the particles below 0.25 mm and the last one which was the mixture of particles above and below this border grain size value.

Results of this kind of investigations shown that overall yield of organic compounds was significantly lower in homogenized sample, as well as the number of identified organic groups. Following Tables 10-12, presents the identified organic groups with their concentrations for each fraction on three different pyrolysis temperatures. Dominant group remains compounds containing nitrogen, amines and amides, but its concentration share increases up to 80%, followed by alcohols (~10%). Those two groups together have a concentration share between 85-95% for all designed fractions at different pyrolysis temperature. Dominant compound is *n,n*-dimethylcyclohexanamin, which share varies from 57-74%. As it can be seen, homogenization of the sample had a huge impact on the yield of organic compounds and their variety. While non-homogenous sample has a yield of 19 different groups, number of groups identified in homogenized samples is almost half of this. It is important to notice that homogenization lead to avoidance in yield of highly toxic and potentially harmful groups such as furans [17] and phthalates [16], which were founded in non-homogenous sample.



Table 10- Identified organic compounds of fraction with particles above 0.25 mm

Pyrolysis temperature	500 °C	600 °C	700 °C
<b>Organic compounds [ng/mg]</b>			
<b>Compounds containing nitrogen</b>	<b>2 093</b>	<b>1 905</b>	<b>2 012</b>
<i>n,n-dimethylcyklohexanamine</i>	1 606	1 441	1 552
<i>n,n-dimethylbenzenemethanamine</i>	205	296	305
<i>n-methylcyklohexanamine</i>	188	64	52
<b>Aromatic hydrocarbons</b>	<b>21</b>	<b>17</b>	<b>16</b>
<i>Chlorobenzene</i>	8	11	9
<i>Toluene</i>	6	6	4
<i>Butylated hydroxytoluene</i>	7		3
<b>Alcohols</b>	<b>272</b>	<b>323</b>	<b>217</b>
<i>2-ethyl-1-hexanol</i>	134	106	100
<i>n,n-diethylaminoethanol</i>	83	130	75
<b>Carboxylic acids</b>	<b>7</b>	<b>7</b>	<b>5</b>
<b>Alkanes</b>	<b>59</b>	<b>28</b>	<b>16</b>
<i>1,2-dichloropropane</i>	10		2
<i>2,2-di(2'-chloroethoxy)-propane</i>	26	12	2
<b>Alkadiens</b>	<b>0</b>	<b>2</b>	<b>2</b>
<b>Aldehydes, ketons</b>	<b>54</b>	<b>47</b>	<b>24</b>
<i>Cyclohexanone</i>	33	37	15
<b>Compounds containing phenol</b>	<b>19</b>	<b>11</b>	<b>15</b>
<i>2-(dimethyl amino)phenol<sup>2</sup></i>			
<b>Ethers</b>	<b>9</b>	<b>7</b>	<b>6</b>
<i>tri(propylene glycol) propyl ether</i>	5	5	4
<i>1-chloro-2-propanol phosphate</i>	4	2	2
<b>PAHs</b>	<b>8</b>	<b>10</b>	<b>9</b>
<i>2,3-dihydro-1,4-dioxin</i>			
<b>Hydrazine</b>	<b>3</b>	<b>0</b>	<b>0</b>
<b>Unknown</b>	<b>239</b>	<b>6</b>	<b>6</b>
<b>Total</b>	<b>2 785</b>	<b>2 362</b>	<b>2 326</b>

Table 10, presents the results of the analytical pyrolysis for the sample with particle size above 0.25 mm. All identified groups are listed with their concentrations and most prominent organic compounds from this group. As was already mentioned, dominant compound with a highest yield is n,n-dimethylcyklohexanamine, whose share is around 77% on all three temperatures. N,n-dimethylcyklohexanamine is a flammable, toxic compound which produce nitrogen emissions during it decomposition. Those concentrations in which are founded are strongly dangerous to human health [45]. Aromatic hydrocarbons have a weak yield, with less than 1% share, but importantly there is an absence of benzene and styrene, which are classified as dangerous compounds. Alcohols, which are second most

<sup>2</sup> If the concentration of a compound is not listed next to the name, it means that this is only detected compound of a specific group

abundant group, consists of an organic compounds which are dangerous, but not carcinogen even though their concentrations are multiple times above recommended one. It is interesting to notice that only one polycyclic aromatic hydrocarbon was founded, comparing to 20 from non-homogenous sample. Moreover, this 2,3-dihydro-1,4-dioxin was not founded during non-homogenous sample analysis, while most common PAHs such as naphthalene, quinoline or benzene based PAHs are avoided with this kind of homogenization.

**Table 11-Identified organic compounds of fraction with particles below 0.25 mm**

<b>Pyrolysis temperature</b>	<b>500 °C</b>	<b>600 °C</b>	<b>700 °C</b>
<b>Organic compounds [ng/mg]</b>			
<b>Compounds containing nitrogen</b>	<b>1 469</b>	<b>2 411</b>	<b>1 902</b>
<i>n,n-dimethylcyclohexanamine</i>	1 125	1 786	1 380
<i>n,n-dimethylbenzenemethanamine</i>	192	355	244
<i>n-methylcyclohexanamine</i>	114	193	207
<b>Aromatic hydrocarbons</b>	<b>15</b>	<b>23</b>	<b>21</b>
<i>Toluene</i>	4	6	6
<i>Cholorobenzene</i>	7	11	9
<i>Butylated Hydroxytoluene</i>	1	3	4
<i>Styrene</i>	3	3	2
<b>Alcohols</b>	<b>201</b>	<b>339</b>	<b>290</b>
<i>n,n-dimethylaminoethanol</i>	81	158	131
<i>2-chloro-n,n-dimethylethanamine</i>	44	80	60
<i>2-ethyl-1-hexanol</i>	58	84	76
<b>Carboxylic acids</b>	<b>5</b>	<b>11</b>	<b>6</b>
<b>Alkanes</b>	<b>6</b>	<b>44</b>	<b>8</b>
<b>Alkadiens</b>	<b>3</b>	<b>8</b>	<b>5</b>
<b>Aldehydes,ketons</b>	<b>24</b>	<b>44</b>	<b>41</b>
<i>cyclohexanone</i>	23	31	32
<b>Compounds containing phenol</b>	<b>8</b>	<b>11</b>	
<i>2-(dimethylamino)phenol</i>			
<b>Alkenes</b>	<b>0</b>	<b>12</b>	<b>1</b>
<b>Unknown</b>	<b>7</b>	<b>19</b>	<b>28</b>
<i>bis(2-ethylhexyl)phthalate</i>	4	9	7
<i>1-chloro-2-propanol phosphate (3:1)</i>	0	3	1
<b>Total</b>	<b>1 738</b>	<b>2 923</b>	<b>2 302</b>

Table 11, presents the results of the analytical pyrolysis for homogenized sample with particle size below 0.25 mm. Visible difference, compared to the results from Table 10, is yield of organic compounds on 500 °C, which is almost for 1 000 ng/mg lower. Furthermore, yield of the organic compounds on 600 °C is increasing and it is 2 923 ng/mg, which is 60% comparing to the previous pyrolysis temperature. Yield of the organic compounds on 700 °C is decreasing and it is the similar to one from particles above 0.25 mm. Dominant group with

highest abundance remains compounds containing nitrogen (amines and amides). Compound with highest yield is *n,n*-dimethylcyclohexanamine, even though his share is lower than in previous case and it is around 60%. Most interesting to notice is lower yield of *n,n*-dimethylcyclohexanamine on 500 °C for almost 500 ng/mg, this is biggest reason for overall lower abundance. The other two compounds with significant yield: *n,n*-dimethylbenzenemethanamine and *n*-methylcyclohexanamine have an yield increment on 600 and 700 °C, while the yield of *n,n*-dimethylcyclohexanamine is also slightly higher. Second prominent group are alcohols, whose share is around 12%, mostly with same dominant compounds, except here can be found 2-chloro-*n,n*-dimethylethanamine, which was not identified in previous sample. Important to notice is absence of PAHs in this sample, as well as low yield of phthalates and styrene which were not present in sample with particle sizes above 0.25 mm.

**Table 12-Identified organic compounds of mixture with particles above and below 0.25 mm**

<b>Pyrolysis temperature</b>	<b>500 °C</b>	<b>600 °C</b>	<b>700 °C</b>
<b>Organic compounds [ng/mg]</b>			
<b>Compounds containing nitrogen</b>	<b>746</b>	<b>932</b>	<b>1 451</b>
<i>n,n</i> -dimethylcyclohexanamine	587	682	1 270
<i>n,n</i> -dimethylbenzenemethanamine	97	113	53
<i>n</i> -methylcyclohexanamine	15	79	67
<b>Aromatic hydrocarbons</b>	<b>6</b>	<b>7</b>	<b>4</b>
<i>Cholorobenzene</i>	4	4	2
<i>Butylated Hydroxytoluene</i>	2	3	2
<b>Alcohols</b>	<b>60</b>	<b>71</b>	<b>34</b>
<i>2-ethyl-1-hexanol</i>	47	46	32
<b>Carboxylic acids</b>	<b>30</b>	<b>23</b>	<b>41</b>
<b>Alkanes</b>	<b>6</b>	<b>19</b>	<b>8</b>
<b>Aldehydes,ketons</b>	<b>30</b>	<b>50</b>	<b>26</b>
<i>Cyclohexanone</i>	17	13	5
<i>2-propenal</i>	3	33	19
<b>Compounds containing phenol</b>	<b>4</b>	<b>5</b>	<b>1</b>
<i>2-(dimethylamino)phenol</i>			
<b>Alkenes</b>	<b>30</b>	<b>5</b>	<b>0</b>
<b>Unknown organic matter</b>	<b>18</b>	<b>72</b>	<b>150</b>
<b>PAHs</b>	<b>6</b>	<b>6</b>	<b>4</b>
<i>cyclopenta(cd)pyrene</i>			
<b>Alcanoates</b>	<b>6</b>	<b>1</b>	<b>0</b>
<b>Total</b>	<b>942</b>	<b>1 192</b>	<b>1 719</b>

In the Table 12, presented are results obtained from mixture of particles below and above 0.25 mm. Interesting is to notice that overall yield of organic compounds on all pyrolysis temperature for this kind of mixture is significantly lower compared to the separate fractions.

At 500 °C overall yield is only 943 ng/mg, again with dominance of amines and amides (80%). Dominant compound is once again *n,n*-dimethylcyclohexanamine (62%). Compared to the fractions analysis, concentrations of alcohols is significantly lower, around 6% at 500 and 600 °C, while its share at 700 °C is only 2%. Share increment is noticed for carboxylic acids, aldehydes, ketones and alkenes, even though their concentrations in ng/mg are similar to the previous cases. At 700 °C, abundance of unknown organic matter is 150 ng/mg, which is almost 9% of all detected compounds. For the first time, it is detected compound 2-propenal known as Acrolein, which is used as chemical precursor for pyridines or as a plasticizer. This compound is strongly toxic and according to The Occupational Safety and Health Administration (OSHA), exposure to it should not be more than 0.1 ppm during the working time. Another interesting phenomena is formation of PAHs. As it can be seen, one PAH was founded in the fraction above 0.25 mm and none of them is founded in fraction below 0.25 mm. In mixture with those two fractions, PAHs are detected again with slightly lower yield. More importantly, compound which was detected cyclopenta(cd)pyrene was not founded in non-homogenous sample or in fraction with particles above 0.25 mm.

#### **4.3.1. Homogenized samples- results overview**

Results of non-homogenous sample analysis showed a wide variety of organic groups and compounds may be produced during the decomposition process of WRPUF. Furthermore, great number of carcinogen compounds was detected such as PAHs, benzene based compounds, furans and phthalates. Compounds containing chlorine were also identified in non-homogenous sample with significant abundance and some of those compounds are classified as hazardous and danger. Since behavior of non-homogenous mixtures is hardly predictable and controllable, homogenization of sample is often used to design desirable properties of mixtures. Therefore, homogenization of this mixture led to huge decrease in organic compounds yield. First of all, detected concentrations of organic compounds in homogenized sample were almost three times lower compared to non-homogenous sample. Secondly, more than 250 organic compounds were detected in this mixture, comparing to only 37, 38 and 41 organic compounds detected in fraction with particle size above 0.25 mm, below 0.25 and designed mixture, respectively. Thirdly, all three designed fractions have an absence of hazardous compounds such as furans, oxiranes and phthalates, as well as the significant abundance decrease of harmful compounds such as PAHs, alkadiens and aromatic hydrocarbons. Finally, number of potentially carcinogen compounds in designed samples was considerably lower and their concentrations are mostly under permissible rate. Also, it is

interesting to compare the yield of chlorine containing compounds in designed mixtures and non-homogenous one. Results of this analysis are presented in Figure 26.

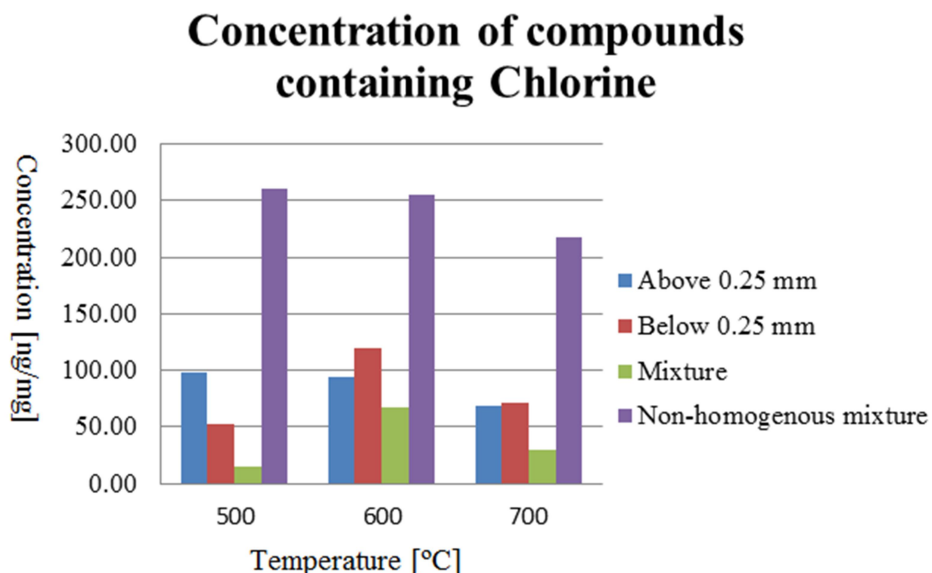

**Figure 26- Comparison of Compounds containing chlorine**

Homogenization of the sample had a huge impact on the yield of chlorine containing products, but also it is interesting to notice that the structure of those products is completely different in non-homogenous and homogenous mixtures. Detected compounds of non-homogenous mixture were strong and toxic benzene based compounds and acids, while structure of homogenous samples was compounds from different organic groups, mostly with low toxicity. Dominant compound in both cases is 2-chloro-n,n-dimethylethanamine with share from 50-85%. Compounds which are detected in homogenous mixtures are listed below:

1. 2-chloro-n,n-dimethylethanamine
2. Chlorobenzene
3. 2,2-di(2'-chloroethoxy)propane
4. 1-chloro-2-propanol phosphate (3:1)
5. 1,2-dichloropropane
6. n2-(2-chloro-5-nitrobenzylide)-2-iodobenzhydrazide
7. 1,1-dichloroethane
8. Decyl ester 2-chlorobenzoic acid
9. 1-(6-chloropiperonyl)-3-sulfamoyl-1,2,4-triazol

10. n-(4-chloro-2-methoxyphenyl)cyclohexanecarboxamide

Compounds listed from 1.-4., are founded in both fractions with particles below and above 0.25 mm, while compounds listed from 7.-10., are detected only in designed mixture. Even though the fractions share similar compounds, their yield is noticeably different on 500 and 600 °C. Reason for that is yield of 2,2-di(2'-chloroethoxy)-propane, which is different on this two temperatures and presence of 1,2-dichloropropane in fraction with particles above 0.25 mm. Former one is founded in traces at 500 °C for fraction with particles below 0.25 mm, but it share increases on 600 °C, while situation is vice versa for other fraction. Surprisingly, this compound did not have any yield in designed mixture. Designed mixture shows the best properties related to the chlorine yield, since their presence at 500 and 700 °C is in traces, while on 600 °C is around 67 ppm, but still considerably lower compared to other samples.

Another important part of the analysis is the yield of gaseous products. Since that designed mixture showed the best properties related to the organic compounds composition, result of this investigation are presented in Figure 27.

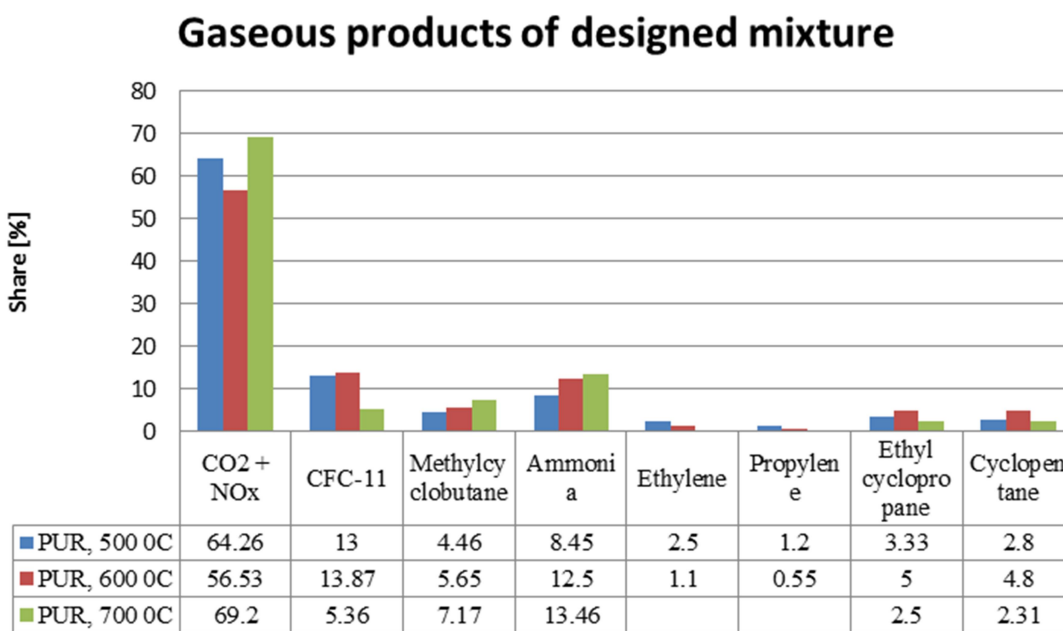

**Figure 27- Yield and composition of gaseous products from designed mixture**

Similar to the non-homogenous sample, dominant products of thermal degradation are CO<sub>2</sub> and NO<sub>x</sub> emissions. Their share is approximately 14% lower compared to the non-homogenous mixture at temperatures 500 and 700 °C and 10% lower for those at 600 °C.

Biggest share of those products, 69% is evolved at 700 °C, while lowest emissions are detected at 600 °C with share of 56.5%. Interesting is to compare the yield of CFC-11 between non-homogenous and designed mixture. In the former one, highest yield was detected at 700 °C with share of 14.6%, while at the 500 and 600 °C, evolved emissions were only 1.4% and 6.7%, respectively. On the other hand, designed mixture had biggest share of 13.9% at 600 °C, slightly lower 13% at 500 °C, while at 700 °C was only 5.4%. Third biggest share of gaseous products belongs to ammonia (NH<sub>3</sub>). At the 600 and 700 °C, evolved emissions are significant with share of 12.5% and 13.5%, respectively. At 500 °C emission are slightly lower, but still not neglectable 8.5%. Non-homogenous sample for comparison had ammonia products only in traces with no more than 1.7% share. Methylcyclobutane is the last gaseous product which is detected with significant share on all three pyrolysis temperatures. Its share continuously increases from 4.5% on 500 °C to 7% at 700 °C. Methylcyclobutane is not classified as dangerous species and it is not detected in non-homogenous mixture. Two products which are detected in traces are ethylene and propylene. Those products do not evolve at 700 °C, and in general they are not classified as dangerous or harmful to human health. Interesting is comparison with the results of non-homogenous mixture, which had yield of ethylene and propylene oxides in significant share, especially the bottom one (18% at 600 °C). Both of those oxides are strongly toxic and dangerous and homogenization leads to their absence in gaseous products of designed mixture. Last two gaseous products are cyclopentane and ethyl cyclopropane with low share. They are flammable compounds but they are not classified as treat for human health, especially with this low share.

#### **4.4. Fraction analysis**

Additional fractionation, presented in Table 5, was performed in order to achieve pronouncedly homogenous mixtures. Furthermore, it is interesting to inspect the effect of the grain size on the yield of organic compounds and gaseous products. Analysis was performed at pyrolysis temperature 600 °C. Figure 28, presents the yield of a different groups from inspected fractions.

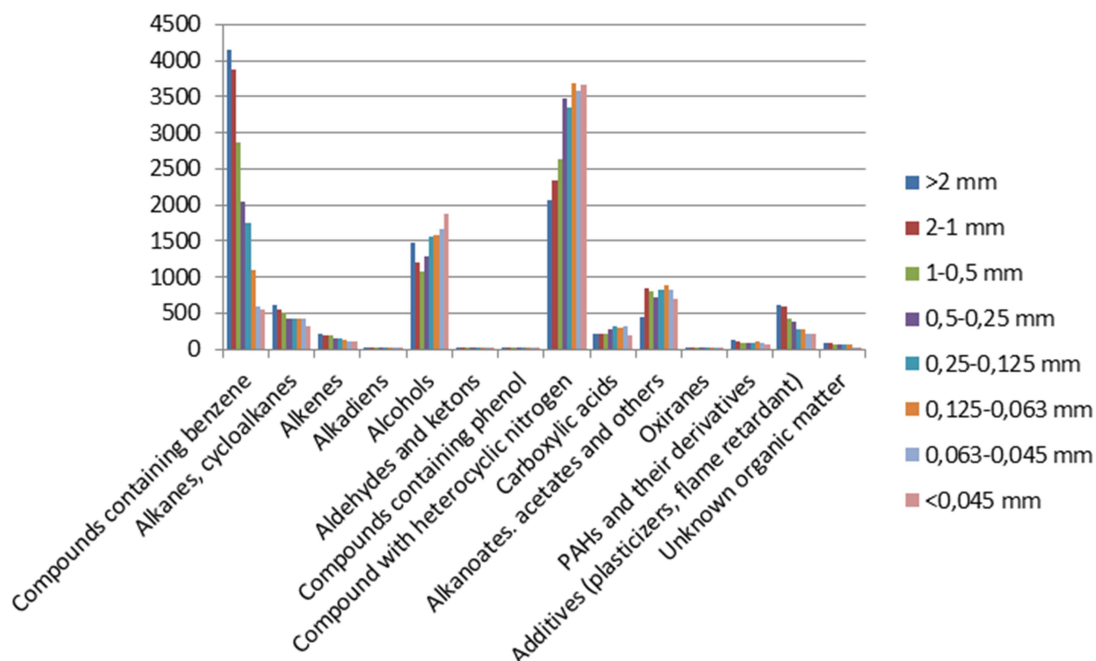

**Figure 28- Yield of organic compounds from different fractions**

Around 70 different compounds divided into 13 various groups was identified. Comparing to the homogenized samples, it is visible that the number of organic compounds is almost doubled with additional fractionation analyzed here. Highest yield is noticed for fractions with particle size above 2 mm and particle size between 1-2 mm with concentrations 10 043 and 10 025 ng/mg, respectively. Lowest yield is detected for fraction with particle size below 0.045 mm and it is 7 722 ng/mg. From presented results it is visible that yield of an organic compounds and their diversity depends on grain size. Dominant are compounds wich are containing nitrogen and benzene, followed by alcohols. Some compounds are presented in traces (alkadiens, aldehydes, ketons, etc.). Also, it is visible from Figure 28, that significant amount of flame retardants and plasticizer can be detected, especially for rougher fractions. Figure 29, presents overall concentration yield for each analyzed fraction.



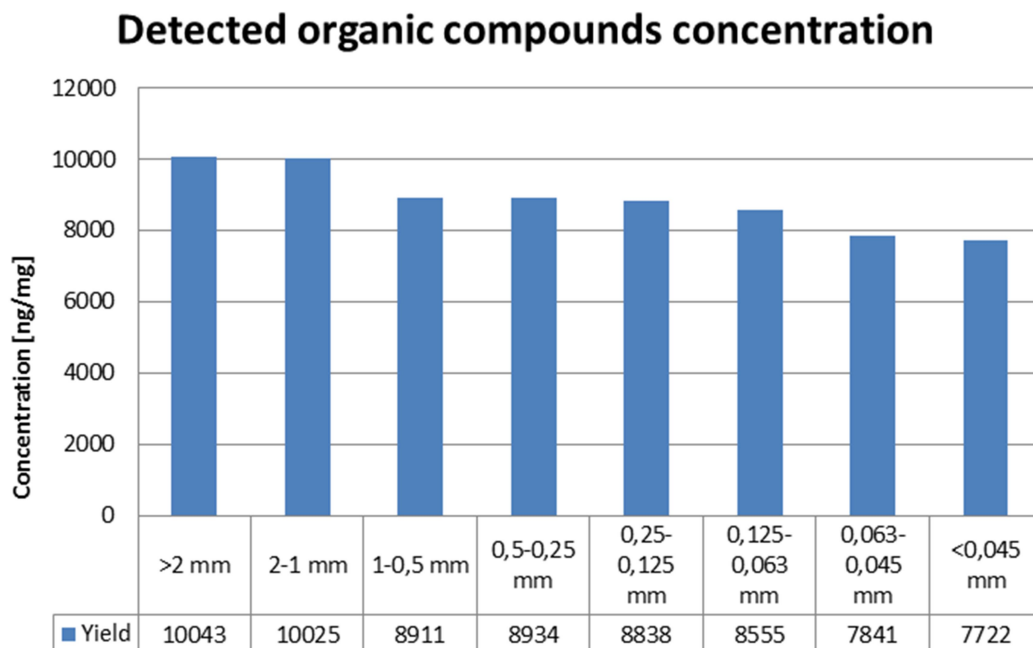

**Figure 29-Detected organic compounds in analyzed fractions**

Table 13, presents detected groups and their concentrations for every analyzed fraction. All detected groups were presented in every fraction mixture in similar share, with few exemptions which are varying over bigger range. Groups which are consisting of strongly hazardous and toxic compounds, such as PAHs, oxiranes or alkanooates, are founded in smaller, but not neglectable concentrations.

**Table 13- Concentrations of detected groups**

Grain size (mm)	Compounds containing benzene	Alkanes, cycloalkanes	Alkenes	Alkadiens	Alcohols	Aldehydes and ketones	Compounds containing phenols	Compound with heterocyclic nitrogen
<0.045	547.1	312.9	102.7	10.3	1872.8	4.8	24.9	3663.1
0.045-0.063	582.8	413.3	103.2	9.5	1674.9	4.3	13.2	3583.7
0.063-0.125	1088.7	415.8	130.4	10.2	1573.5	8.0	15.9	3691.9
0.125-0.25	1755.2	414.1	144.3	11.0	1568.5	9.0	17.1	3344.4
0.25-0.50	2035.4	414.4	155.7	15.1	1284.9	10.9	15.7	3474.8
0.5-1.0	2855.7	514.9	182.1	18.4	1067.9	14.8	14.9	2642.4
1.0-2.0	3868.3	550.4	196.1	28.8	1191.1	13.8	14.9	2329.5
>2	4148.7	614.0	205.0	32.0	1468.2	4.9	11.0	2070.6

Grain size (mm)	Carboxylic acids	Alkanoates, acetates and others	Oxiranes	PAHs and their derivatives	Additives (plasticizers, flame retardant)	Unknown organic matter	Sum of organic matter
<0.045	188.5	702.5	2.8	68.2	210.5	11.3	<b>7722.4</b>
0.045-0.063	310.8	811.7	3.9	88.0	212.7	29.7	<b>7841.8</b>
0.063-0.125	288.5	879.8	5.0	98.0	284.1	65.5	<b>8555.1</b>
0.125-0.25	310.6	821.8	7.8	94.6	276.5	62.7	<b>8837.7</b>
0.25-0.50	277.6	722.4	5.5	76.3	388.5	56.9	<b>8934.1</b>
0.5-1.0	210.7	804.3	3.1	89.1	421.2	71.3	<b>8910.7</b>
1.0-2.0	210.8	844.2	1.3	108.2	586.2	81.6	<b>10025.2</b>
>2	211.1	445.5	0.8	136.2	612.8	81.8	<b>10042.6</b>

The thermal decomposition of the sample from the individual grain-size classes provides different concentrations of organic compounds in the pyrolysate (Table 13). Comparison of the determined concentration of organic compounds in the samples from the individual grain-size classes (quantity balance) with the bulk sample shows a fairly good match, with the exception of the compounds with heterocyclic nitrogen, where the difference is up to 43%. The content of compounds with heterocyclic nitrogen is higher in the sorted samples.

The highest concentrations of compounds containing benzene, alkanes, cycloalkanes, alkenes, PAHs and their derivatives, and additives were found for pyrolysates prepared from particles > 0.5 mm. Increased concentrations of these compounds are related to the higher content of plastics and rubber particles in the sample. The highest concentrations of alcohols,

nitrogen heterocyclic compounds and carboxylic acids occur in grain-size classes <0.5 mm. Increased concentrations of these compounds (higher than the arithmetic mean value) are likely to be associated with faster decomposition of smaller PU particles, which is indicated by a decrease in concentration with an increasing particle size. The highest mass particle yield was found for the grain-size class 0.063-0.125 and 0.125-0.25 mm, which is 47%. High mass yield also affects the yield rate, which is up to 62% in nitrogen heterocyclic compounds for particles below 0.25 mm.

Constitution of gaseous products which are evolved during fractions decomposition at 600 °C is presented in Figure 30. Carbon dioxide and nitrogen emissions remain dominant gaseous products for all fractions. Highest shares of these two products are detected in fraction with particle size above 2 mm (61.5%) and for the fraction with particles below 0.045 mm. Lowest abundance of this products are noted for fraction with particle size between 0.25-0.125 mm, where it shares is only 33.5%. For the same fraction, share of CFC-11 was extremely high 32%. Record share of CFC-11 is noted for fraction with particles size between 0.125-0.063 mm and it is 42.5%. In general, evolution of CFC-11 emissions was extremely unpredictable for homogenized fractions, since their share is fluctuating between presence in traces to being almost dominant product. Interesting phenomena is increment of CFC-11 share from 13.3% (particles above 2 mm) to 21% (particles between 0.5-0.25 mm), followed by dramatic fall to only 2.5% (particles 0.25-0.125 mm) and then exponential growth to 32% and 42.5% for next two fractions. Ammonia, product which requires special attention, is presented in all examined fractions with significantly different share rate. Highest, 17% share rate is detected for fraction with particles between 0.5-0.25 mm. Lowest share is only 4.5%, for particles above 2 mm. Chloromethane and propylene oxide are detected in some rougher fractions. Those two products are of high concern, since their extreme toxicity. Former one, chloromethane is detected in fractions with particle size above 0.5 mm, while propylene oxide evolved in fractions with particle size above 1 mm. Even though they share is lower than 1%, nature and toxicity of those gases should not be neglected.

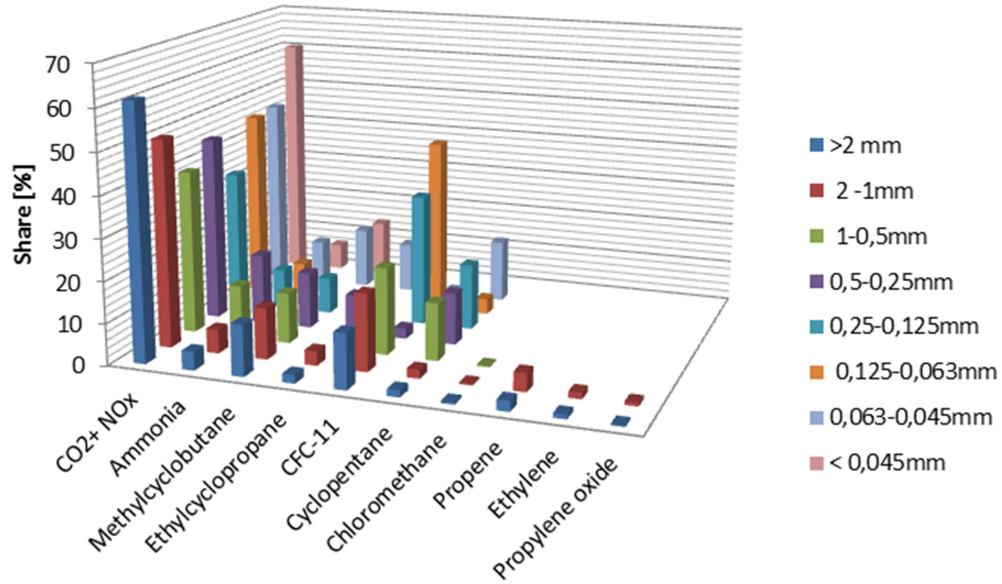

Figure 30- Gaseous products from different fractions at 600 °C

Detail overview of gaseous composition with corresponding shares for each fraction is listed in Table 14. Methylcyclobutane, cyclopentane and ethylcyclopropane are detected for almost every fraction with considerable share. Nevertheless, they are not representing significant threat to human health, similar as propene and ethylene which are detected in smaller share.

Table 14- Composition of gaseous products for analyzed fractions

Particle size [mm]	>2	2 -1	1-0,5	0,5-0,25	0,25-0,125	0,125-0,063	0,063-0,045	<0,045
Product share [%]								
CO <sub>2</sub> + NO <sub>x</sub>	61.6	50.3	39.6	44.9	33.5	45.7	46.2	60.3
Ammonia	4.5	5.8	12.7	16.9	9.7	8.0	10.5	6.4
Methylcyclobutane	12.4	12.4	12.3	13.7	8.9		14.8	13.6
Ethylcyclopropane	2.1	3.5		9.4			12.1	19.7
CFC-11	13.3	18.6	21.1	2.5	32.0	42.5	1.1	
Cyclopentane	1.7	2.1	13.9	12.6	16.1	3.8	15.2	
Chloromethane	0.5	0.4	0.4					
Propene	2.5	4.5						
Ethylene	1.1	1.5						
Propylene oxide	0.4	0.9						

## 5. Conclusion

The thesis presents the results of thermal degradation of waste rigid polyurethane foam. Selected sample was conducted to thermal analysis in order to examine the yield of organic compounds and gaseous products during the decomposition process. Before sample was conducted to thermal analysis, XRF spectrometry and particle sizing was performed in order to examine material structure and to determine what kind of sample preparations are needed. This analysis showed strong non-homogenous structure of a sample and presence of many different chemical elements. Biggest concern is given to the high presence of chlorine (3.7-4%), a strongly corrosive and hazardous element. Furthermore, content of chlorine for Refuse-derived fuel (RDF), should not be more than 1%.

Pyrolysis coupled with gas chromatography-mass spectrometry (Py/GC-MS) was carried out on a non-homogenous mixture, three different homogenized mixtures and eight fractions at 500, 600 and 700 °C. Obtained results are presented in several tables and figures, compared to each other, and afterwards to similar previous investigations. In non-homogenous mixtures dominant group were amines and amides, with share between 23-44%. Significant yield is noted for aromatic hydrocarbons, alcohols and alkanates. Non-homogenous mixture had a significant yield of chlorine containing and carcinogenic compounds. Carcinogenic compounds were often benzeno-based one, while considerable amount of PAHs was detected as well. Homogenous sample mixtures had a significantly lower overall yield of organic compounds, while dominant group remained amines and amides, whose share was above 80%. Big decrease in abundance of hazardous compounds was detected as well. First of all, yield of chlorine containing compounds was considerably lower for all designed homogenized mixtures. Especially this phenomena was noted for mixture with particle size below and above 0.25 mm, where yield was 17, 4 and 13 times lower at the 500, 600 and 700 °C, respectively. Same mixtures had around 50% decrease in abundance of PAHs, while mixture with particles below 0.25 mm had an absence of it. Analysis of gaseous products showed that homogenization of mixture, lead to changes in gaseous compositions comparing to the non-homogenous mixture. In both cases, dominant gaseous products are carbon dioxide and nitrogen emissions. Non-homogenous mixture had share of CO<sub>2</sub> and -NO<sub>x</sub> in range 45-78%, while homogenized mixture share was from 56 to 69%. Highly toxic alkene oxides were removed in homogenous mixture, but this caused increment in share of CFC-11 and ammonia emissions. Former one increased from 7.6% to

10.7%, while ammonia increased from 1% to 11.5%. Other detected gaseous products were harmless cycloalkanes and alkenes.

Fractions investigation was carried out in order to determine the grain size effect on the decomposition process. Different grain size have same dominant compound as previous mixtures, n,n-dimethylcyclohexanamine, whose share was around 50%, while overall share of amines and amides was up to 70%, depending on a grain size. Analysis of gaseous products showed that some fractions have concerning share of CFC-11 emissions, up to 41%. Dominant product remains CO<sub>2</sub> and -NO<sub>x</sub> emissions with average share of 47%. Average share of ammonia is around 9%, while in some fractions it has been detected the presence of chloromethane. Other products are different harmless cycloalkanes and alkenes depending on fraction.

It is clear that investigated sample had too high share of chlorine, therefore production of RDF from this waste in this form is not possible. Nevertheless, it would be of interest, because of its high calorific value, to mix this waste with some other low chlorine waste (biomass, paper, etc.) in order to produce RDF. This kind of mixing would decrease chlorine content and increase a possibility of energy recovery from this material. Furthermore, this kind of mixture could be pelatized and designed with desirable properties and then used as a fuel. Several investigations related to this problem were already performed, where metal salts were used to decrease the yield of chlorine compounds [46-48]. Some of this method were successful and the concentration of harmful compounds were decreased. To prove those assumptions on this sample, further investigations should be performed.

## Bibliography

- [1] European Commission, "Council directive 1999/31/EC on the landfill of waste," 31999L0031, 1999.
- [2] Manfred Kapps and Siegfried Buschkamp, "The production of rigid polyurethane foam," Leverkusen, 2004.
- [3] Hans-Wilhelm Engels et al., "Polyurethanes: Versatile Materials and Sustainable Problem Solvers for Today's Challenges," *Angewandte Chemie International Edition*, vol. 52, no. 36, 2013.
- [4] Anurag Garg, Richard Smith, Daryl Hill, and Nigel Pollard, Simon Simms, "Wastes as Co-Fuels: The Policy Framework for Solid Recovered Fuel (SRF) in Europe, with UK implications," vol. 41, 2007.
- [5] Wikipedia. [Online]. [https://en.wikipedia.org/wiki/X-ray\\_fluorescence](https://en.wikipedia.org/wiki/X-ray_fluorescence)
- [6] Innov-X Systems, Inc., "User Manual," 2005-2010.
- [7] Michael E. Brown, *Handbook of Thermal Analysis and Calorimetry -Volume 1*, Patrick K. Gallagher, Ed.: Elsevier, 1998., vol. 1.
- [8] Li-Xin Duan, Xiaoquan Qi Zhen Xue, "Gas chromatography-Mass spectrometry Coupling techniques," in *Plant Metabolomics*, K. Qi, X. Chen, and Wang Y., Eds.: Springer, 2015.
- [9] NETZSCH-Gerätebau GmbH, "TGA-GC-MS Coupling," 2012.
- [10] James M. Guthrie. (2012, August) The Archaeometry Laboratory at the University of Missouri Research Reactor. [Online]. [http://archaeometry.missouri.edu/xrf\\_overview.html](http://archaeometry.missouri.edu/xrf_overview.html)
- [11] European Commission, "DIRECTIVE 2010/75/EU OF THE EUROPEAN PARLIAMENT AND OF THE COUNCIL on industrial emissions (integrated pollution prevention and control)," 32010L0075, 2010.
- [12] Hui Wang, Qing-song Wang, Jia-Jia He, Zhan-Li Mao, and Jin-Hua Sun, "Study on the Pyrolytic Behaviors and Kinetics of Rigid Polyurethane Foams," vol. 52, 2013.
- [13] He Jia-Jia, Jiang Lin, Sun Jin-Hua, and Lo Siuming, "Thermal degradation study of pure rigid polyurethane in oxidative and non-oxidative atmospheres," vol. 120, 2016.
- [14] Lingling Jiao, Huahua Xiao, Qingsong Wang, and Jinhua Sun, "Thermal degradation

- characteristics of rigid polyurethane foam and the volatile products analysis with TG-FTIR-MS," vol. 98, no. 12, 2013.
- [15] Ki-Hyun Kim, Shamin Ara Jahan, Ehsanul Kabir, and J.C.Richard Brown, "A review of airborne polycyclic aromatic hydrocarbons (PAHs) and their human health effects," vol. 60, 2013.
- [16] Workplace Environment Solutions Ltd., "Tris(2-chloro-1-methylethyl) phosphate-Summary risk report," CAS 13674-84-5, 2008.
- [17] ChemistryViews. (2010, November) ChemistryViews. [Online].  
[http://www.chemistryviews.org/details/news/876319/Toxicity\\_of\\_Furan.html](http://www.chemistryviews.org/details/news/876319/Toxicity_of_Furan.html)
- [18] American Chemistry Council. [Online].  
<https://plastics.americanchemistry.com/plastics/The-Basics/>
- [19] Ron Zevenhoven, "Treatment and disposal of polyurethane wastes: Options for recovery and recycling," Espoo, ISB 951-22-7161-3, 2004.
- [20] PlasticsEurope, "Plastics -the Facts 2016," , Brussels, 2016.
- [21] Harpal Singh and A.K. Jain, "Ignition, combustion, toxicity and fire retardancy of Polyurethane foams: A comprehensive review," *Journal of applied polymer science*, vol. 111, no. 2, 2008.
- [22] Matsunaga K, Ed., *Fundamentals and Applications in Polyurethanes*. Tokyo: CMC, 2000.
- [23] Austrian Federal Ministry of Agriculture, Forestry, Environment and Water Management, *Waste-to-Energy in Austria*, 2nd ed., Forestry, Environment and Water Management Austrian Federal Ministry of Agriculture, Ed. Vienna: Austrian Federal Ministry of Agriculture, Forestry, Environment and Water Management, 2010.
- [24] M. Herrera, G. Wilhelm, G. Matuschek, and A. Kettrup, "Thermoanalytical and pyrolysis studies of nitrogen containing polymers," vol. 58-59, no. 1, 2001.
- [25] R Font, A. Fullana, J.A. Caballero, J. Candela, and A. Garcia, "Pyrolysis study of polyurethane," vol. 58, 2001.
- [26] Xiaoya Guo, Lixin Wang, Li Zhang, Shouguang Li, and Jinyu Hao, "Nitrogenous emissions from the catalytic pyrolysis of waste rigid polyurethane foam," *Journal of Analytical and Applied Pyrolysis*, vol. 108, 2014.



- [27] Xiaoya Guo, Wei Zhang, Lixin Wang, and Hao Jinyu, "Comparative study of nitrogen migration among the products from catalytic pyrolysis and gasification of waste rigid polyurethane foam," vol. 120, 2016.
- [28] SGS / What you need to be sure. [Online]. <http://www.sgs.com/en/mining/analytical-services/coal-and-coke/proximate-and-ultimate-analysis>
- [29] GmbH, Bruker AXS, "Introduction to X-ray Fluorescence Analysis (XRF)," Karlsruhe, DOC-M84-EXS001 V8., 2016.
- [30] LinguisticDemographer. (2006, December) X-ray Fluorescence. [Online]. <https://commons.wikimedia.org/wiki/File:XRFScan.jpg>
- [31] Bruce R Prime, Harvey E Bair, Sergey Vyazovkin, Patrick E Gallagher, and Alan Riga, "Thermogravimetric Analysis," in *Thermal Analysis of Polymers: Fundamentals and Applications*, Joseph D Menczel and Bruce R Prime, Eds.: John Wiley & Sons, Inc., 2009, ch. 3.
- [32] McGhie, Andrew R; Chiu, J; Fair, P.G; Blaine, L.R, "Thermogravimetric apparatus temperature calibration using melting point standards," vol. 67, no. 2-3, 1983.
- [33] Peter Kusch, *Pyrolysis- Gas chromatography/Mass spectrometry of Polymeric Materials.:* InTech, 2012.
- [34] (1998, January) Gas chromatography-Mass spectrometry background. [Online]. <https://www.gmu.edu/depts/SRIF/tutorial/gcd/gc-ms2.htm>
- [35] Gas chromatography-Mass spectrometry. [Online]. [https://en.wikipedia.org/wiki/Gas\\_chromatography%E2%80%93mass\\_spectrometry](https://en.wikipedia.org/wiki/Gas_chromatography%E2%80%93mass_spectrometry)
- [36] Earth System Research Laboratory-Global Monitoring Division. [Online]. [https://www.esrl.noaa.gov/gmd/outreach/behind\\_the\\_scenes/meas\\_analyzers.html](https://www.esrl.noaa.gov/gmd/outreach/behind_the_scenes/meas_analyzers.html)
- [37] Elena Stasenko and Jairo Rene Martinez, "Gas chromatography-Mass spectrometry, Advances in Gas-chromatography, Dr Xinghua Guo," 2014.
- [38] Wiliam Reusch. (2013, May) Mass spectrometry. [Online]. <https://www2.chemistry.msu.edu/faculty/reusch/virttxtjml/spectrpy/massspec/masspec1.htm>
- [39] Cwenger. (2010, June) Mass chromatogram. [Online]. [https://en.wikipedia.org/wiki/Mass\\_chromatogram](https://en.wikipedia.org/wiki/Mass_chromatogram)

- [40] Supan Wang, Haixiang Chen, and Linge Zhang, "Thermal Decomposition Kinetics of Rigid Polyurethane Foam and Ignition Risk by a Hot Particle," *Journal of Applied Polymer Science*, vol. 131, no. 4, 2013.
- [41] A. Gendebien et al., "Refuse derived fuel, current practice and perspectives," CO 5087-4, 2003.
- [42] Hea Jia-Jia, Jianga Lin, Suna Jin-Hua, and Lo Siuming, "Thermal degradation study of pure rigid polyurethane in oxidative and non-oxidative atmospheres," vol. 120, 2016.
- [43] María A Garrido, Rafael Font, and Juan A Conesa, "Pollutant emissions during the pyrolysis and combustion of flexible polyurethane foam," vol. 52, 2016.
- [44] National Oceanic and Atmospheric Administration. [Online]. <https://www.esrl.noaa.gov/gmd/hats/publicatn/elkins/cfcs.html>
- [45] National Center for Biotechnology Information. The PubChem Project. [Online]. <https://pubchem.ncbi.nlm.nih.gov/compound/7415>
- [46] O. Terakado, H. Yanase, and M. Hirasawa, "Pyrolysis treatment of waste polyurethane foam in the presence of metallic compounds," *Elsevier BV*, vol. 108, no. 0165-2370, pp. 130-135, July 2014.
- [47] Xu Jun and Fang Tingyong, "Experimental study on combustion characteristics for polyurethane-aluminum composite insulation material under different heat flux," *Procedia Engineering*, vol. 62, pp. 837-843, 2013.
- [48] Mikelis Kirpluks et al., "RIGID POLYURETHANE FOAM THERMAL INSULATION PROTECTED," *AUTEX Research Journal*, vol. 14, no. 4, December 2014.