

Analiza proizvodnje u tvornici kabela

Temelini, Giulia

Master's thesis / Diplomski rad

2016

Degree Grantor / Ustanova koja je dodijelila akademski / stručni stupanj: **University of Zagreb, Faculty of Mechanical Engineering and Naval Architecture / Sveučilište u Zagrebu, Fakultet strojarstva i brodogradnje**

Permanent link / Trajna poveznica: <https://um.nsk.hr/um:nbn:hr:235:527189>

Rights / Prava: [In copyright](#)/[Zaštićeno autorskim pravom.](#)

Download date / Datum preuzimanja: **2024-07-17**

Repository / Repozitorij:

[Repository of Faculty of Mechanical Engineering and Naval Architecture University of Zagreb](#)



SVEUČILIŠTE U ZAGREBU
FAKULTET STROJARSTVA I BRODOGRADNJE

University of Zagreb
Faculty of Mechanical Engineering and Naval Architecture

DIPLOMSKI RAD – DIPLOMA THESIS

u okviru/in the frame of ERASMUS+

Giulia Temelini

Zagreb, 2016.

SVEUČILIŠTE U ZAGREBU
FAKULTET STROJARSTVA I BRODOGRADNJE

University of Zagreb
Faculty of Mechanical Engineering and Naval Architecture

DIPLOMSKI RAD – DIPLOMA THESIS

u okviru/in the frame of ERASMUS+

Mentor:



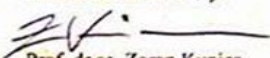
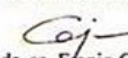
Prof. dr.sc. Zoran Kunica

Student:

Giulia Temelini

Zagreb, 2016.

DIPLOMA THEME

	<p>SVEUČILIŠTE U ZAGREBU FAKULTET STROJARSTVA I BRODOGRADNJE Središnje povjerenstvo za završne i diplomске ispite Povjerenstvo za diplomске ispite studija strojarstva za smjerove: proizvodno inženjerstvo, računalo inženjerstvo, industrijsko inženjerstvo i menadžment, inženjerstvo materijala i mehatronika i robotika</p>									
	<p>UNIVERSITY OF ZAGREB Faculty of Mechanical Engineering and Naval Architecture Central Commission for final exams and graduation Commission for diploma exams of study of Mechanical Engineering for fields: Production engineering, Computer engineering, Industrial engineering and management, Materials engineering and Mechatronics and robotics</p>									
		<table border="1" style="width: 100%; border-collapse: collapse;"> <tr> <th colspan="2">Sveučilište u Zagrebu Fakultet strojarstva i brodogradnje</th> </tr> <tr> <td>Datum:</td> <td>Prilog:</td> </tr> <tr> <td colspan="2">Klasa:</td> </tr> <tr> <td colspan="2">Ur. broj:</td> </tr> </table>	Sveučilište u Zagrebu Fakultet strojarstva i brodogradnje		Datum:	Prilog:	Klasa:		Ur. broj:	
Sveučilište u Zagrebu Fakultet strojarstva i brodogradnje										
Datum:	Prilog:									
Klasa:										
Ur. broj:										
<p>DIPLOMSKI ZADATAK/TASK FOR DIPLOMA THESIS u okviru/in the frame of ERASMUS+</p>										
Student:	GIULIA TEMELINI	Mat. br.: 0035208211								
Naslov rada na hrvatskom jeziku/Title in Croatian:	Analiza proizvodnje u tvornici kabela									
Naslov rada na engleskom jeziku/Title in English:	Analysis of production in the cable factory									
Opis zadatka/Task description:										
The thesis should encompass:										
1. motivation and description of a product/business/phenomena – the cable business and products										
2. the ELKA factory										
2.1. overview of production programme (portfolio) and markets										
2.2. technology (people, machinery and software (SAP, CableBuilder) in business, design and planning, production and other activities)										
2.3. microlocation, buildings, installations and plant (facility) layout										
2.4. processes and departments (management, engineering and production)										
3. ideas on possible improvements (not limited to the content of the section 4.)										
4. analysis of production process by simulation										
4.1. simulation general view										
4.2. simulation aim and model – problem specific for ELKA										
4.2.1. utilisation of machines and handling/transport vehicles (forklifts and overhead cranes)										
4.2.2. choice of representative products (data on quantities (t, km), batch-sizes and packaging are required as well as technology data)										
4.2.3. description of simulation software (Siemens PlantSimulation)										
4.2.4. the making of simulation model (data from technology plans (sequences of machines and times) and about layout (distances) are required)										
4.2.5. the use of the simulation tool (simulation execution, results and their interpretation, view to possible further work)										
5. conclusions, recommendations and suggestions for future work.										
Zadatak zadan/Date of issuing:	Rok predaje rada/Date of thesis submission:	Predviđeni datum obrane/Predicted date of defense:								
2015-12-01	February 2016.	February 2016.								
Zadatak zadan/Issued by:	Predsjednik Povjerenstva/President of the Commission:									
 Prof. dr.sc. Zoran Kunica	 Prof. dr. sc. Franjo Cajner									

STATEMENT

I declare that the work was developed independently using the knowledge gained at university and cited references.

I thank especially to: my mentor in Croatia Professor Zoran KUNICA, my mentor in Italy Professor Alberto REGATTIERI, Mr. Damir LAZANIN and Mr. Martin VLAŠIĆ, both of ELKA d.o.o. for their help in preparing this final work and enabled production data.

I thank my parents Rodolfo and Barbara, my brother Andrea for their support during all these years of schooling.

I want also to say a special thank to my boyfriend, and to all my friends and colleagues for their help during the study.

Giulia Temelini

SUMMARY

This work analyzes various aspects of cable manufacturing taking into account the production process, overview of cable business and markets, and use and implementation of simulation in a cable factory in order to optimize machine utilization.

The focus is on ELKA d.o.o., a Croatian cable manufacturer, which has been described in detail in every aspect, such as product mix, processes and department, layout and technology (machinery and software - CableBuilder and SAP).

Simulation model has been built using the software package Siemens Tecnomatix 11 Plant Simulation. The input data involved number of orders, annual quantities expressed in kilometers and tons, production times, layout distances between machines and other. The simulation runs give results for different alternatives obtained by changing the number of production batches in one year in relation to the number of orders. The purpose is to evaluate the possibility of introduction of a Form Postponement strategy to accelerate the lead times of cable supply and to maximize the utilization of the existing machines. The results are shown in statistical diagrams that contain data about number of parts produced, machine load and total working times. A comparison of results of different alternatives is performed. On the basis of the comparison, in order to accelerate the lead times and to maximize the utilization of the machines, it appears that a Form Postponement strategy is convenient.

A part of this work contains the calculation of the number of forklifts needed for internal transport.

Key words: cables, manufacturing, simulation

SAŽETAK

Rad analizira razne aspekte proizvodnje kabela kao što su proizvodni proces, poslovanje i tržišta te korištenje i implementacija simulacije u tvornici za proizvodnju kabela u svrhu optimiranja iskorištenja strojeva.

Detaljno je opisana hrvatska tvornica ELKA d.o.o., uključujući proizvodni program, proizvodne procese i ustroj, prostorni raspored i tehnologiju (strojevi i softver CableBuilder and SAP).

Simulacijski model načinjen je korištenjem softvera Siemens Tecnomatix 11 Plant Simulation. Ulazni podaci uključivali su broj narudžbi, godišnje proizvodne količine (u kilometrima i tonama), tehnološka vremena, udaljenosti između strojeva i druge. Izvođenjem simulacije uz variranje broja serija u ovisnosti o broju narudžbi, dobiveni su različiti rezultati. Rezultati su prikazani statističkim dijagramima koji sadrže podatke o proizvedenim količinama, vremenskim opterećenjima strojeva i ukupnim vremenima proizvodnje. Na temelju usporedbe rezultata, a za skraćanje ciklusa proizvodnje i povećanje iskorištenja strojeva, kao prikladna se iskazala tzv. strategija *Form Postponement* (odgoda otpočinjanja proizvodnih aktivnosti koje ovise o specifičnom zahtjevu kupca).

Dio rada posvećen je izračunu potrebnog broja viličara za unutarnji transport.

Ključne riječi: kabela, proizvodnja, simulacija

TABLE OF CONTENT

DIPLOMA THEME.....	1
STATEMENT.....	2
SUMMARY.....	3
SAŽETAK.....	4
LIST OF FIGURES.....	7
LIST OF TABLES.....	10
LIST OF BOOKMARKS OF PHYSICAL VARIABLES AND MEASUREMENT UNITS.....	12
1. THE CABLE BUSINESS AND THE PRODUCTS.....	13
1.1. Electrical principles and conductors.....	13
1.2. Types of cables.....	15
1.3. The insulation.....	17
1.4. Cable business and market.....	19
1.5. Market challenge for the future.....	25
2. ELKA FACTORY.....	27
2.1. Description of ELKA.....	27
2.2. Product mix.....	28
2.2.1. High-voltage power cables.....	30
2.2.2. Medium voltage power cables.....	32
2.2.3. Low voltage cables.....	33
2.2.4. Telecommunication cables.....	35
2.3. Technology.....	36
2.3.1. Software.....	37
2.3.2. Machinery.....	45
2.4. Buildings, installations and plant layout.....	47
2.5. Processes and departments.....	50
2.6. Cable manufacturing process.....	52
3. IDEAS ON POSSIBLE IMPROVEMENTS.....	55
4. SIMULATION – A GENERAL VIEW.....	64
5. AIM OF SIMULATION MODELING IN ELKA.....	75
5.1. Production strategies.....	75
5.2. Utilization of machines and handling/transport vehicles.....	80
5.3. Choice of representative products.....	86
6. THE SIMULATION SOFTWARE: SIEMENS (TECNOMATIX) PLANT SIMULATION.....	95

7. THE MAKING OF THE SIMULATION MODEL AND THE RESULTS.....	103
7.1. The simulation model	103
7.2. The use of the simulation tool and analysis of the results	114
5. CONCLUSION	131
8. LITERATURE.....	133

LIST OF FIGURES

Figure 1. Solid and stranded conductors	14
Figure 2. General structure (main components) of a cable	16
Figure 3. EU cable industry hit by reduction in economic growth and lower fixed investment... 19	
Figure 4. Price of copper from 1989 to 2014	20
Figure 5. Price of aluminum from 1989 to 2014.....	21
Figure 6. Eastern Europe cable market	21
Figure 7. Western Europe cable manufacturers	23
Figure 8. Southern European Market	23
Figure 9. ELKA: percentage of sales in different countries, 2013.....	28
Figure 10. Percentage of ELKA cable sales in year 2013.....	30
Figure 11. 2XS(F)2Y, A2XS(F)2Y	31
Figure 12. 2XS(FL)2Y, A2XS(FL)2Y	32
Figure 13. N2XS(FL)2Y, NA2XS(FL)2Y	32
Figure 14. XHE 46/29, XHE 49/24.....	33
Figure 15. FR-N1XD4-AR, FR-N1XD9-AR, FR-NFA2X.....	34
Figure 16. NYY-J 4x240 SM	34
Figure 17. TK59-50xDSL-30Mhz 200x2x0.5 GM	36
Figure 18. Interactive 3D model by CableBuilder software	38
Figure 19. Medium Voltage Cable in 2D by CableBuilder software.....	38
Figure 20. Example of a datasheet by CableBuilder software	39
Figure 21. SAP R/3 modules and integration.....	41
Figure 22. Display and control device ECOCONTROL 6000.....	44
Figure 23. ELKA factory and buildings.....	48
Figure 24. Outside storage area.....	48
Figure 25: Organizational chart.....	50
Figure 26. Stranding operation.....	53
Figure 27. Continuous vulcanization line for high voltage cables	54
Figure 28. Model of AS-IS process of order receiving	56
Figure 29. Model of TO-BE process of order receiving for standard products	57

Figure 30. RFID and ERP integration	60
Figure 31. Kraljic matrix	61
Figure 32. Kanban card	62
Figure 33. Building a credible model	65
Figure 34. Basic simulation model components	67
Figure 35. Simulation project	68
Figure 36. Reduction of time-to-market by using simulation	70
Figure 37. Building manufacturing system model	71
Figure 38. Historical evolution of simulation	72
Figure 39. Metal department processes	77
Figure 40. Conceptual model of Form Postponement strategy [35]	79
Figure 41. Available time for a machine	81
Figure 42. Resource statistics collection for the period in STPS software	82
Figure 43. Optimal batch size	83
Figure 44. Wooden drums for cables	84
Figure 45. Forklift for spools transportation	85
Figure 46. Medium voltage cable N2XS(F)2Y, NA2XS(F)2Y	86
Figure 47. Medium voltage cables N2XSY, NA2XSY	87
Figure 48: Code for designating cables	88
Figure 49. Power cables with XLPE insulation and PVC sheath, NA2XY N2XY	91
Figure 50. Power cable with PVC insulation and sheath NYY, NAYY	92
Figure 51. Modeling 2D and 3D simulation in Siemens (Tecnomatix) Plant Simulation	95
Figure 52. Example of a basic Frame in STPS	97
Figure 53. Processing duration of a part on a station in STPS	98
Figure 54. Bottleneck Analyzer in STPS	99
Figure 55. Sankey's Diagram in STPS	100
Figure 56. Flow of material with Sankey's Diagram in STPS	100
Figure 57. Resource statistics chart in STPS	101
Figure 58. Occupancy statistics chart in STPS	101
Figure 59. Energy statistics chart in STPS	102
Figure 60. Interface of Siemens (Tecnomatix) Plant Simulation with the simulation model	106
Figure 61. ELKA simulation model (2D) in STPS	107
Figure 62. Sankey's diagram for the ELKA simulation model in STPS	108
Figure 63. Amount of empty returning transports	111
Figure 64. Transportation time between two machines	112
Figure 65. Utilization of the machines alternative 1	116
Figure 66. Working and setup times– Alternative 1	117

Figure 71. Utilization of the machines – Alternative 2	119
Figure 72. Working and setup times for machines – Alternative 2.....	121
Figure 68. Utilization of the machine – Alternative 3.....	123
Figure 69. Working and setup times– Alternative 3	125
Figure 74. Utilization of the machines for the alternative four	128
Figure 75. Working and setup times – Alternative 4	129

LIST OF TABLES

Table 1. Physical properties of metals used in cables (20 °C).....	15
Table 2. Comparison of cable insulating materials.....	18
Table 3. Technical parameters of some machines.....	46
Table 4. Advantages and disadvantages of simulation.....	66
Table 5. Comparative matrix of commercial simulation tools.....	74
Table 6. KPI considered for the specific problem.....	76
Table 7. Comparison between MTO, MTS and FP approaches.....	78
Table 8. Layout distances in meters between the machines.....	85
Table 9. Chosen Medium Voltage cables.....	86
Table 10. Size and weight of 12/20/24 kV cables.....	87
Table 11. Size and weight of 18/30/36 kV cables.....	87
Table 12. Sizes and weight of N2XSY, NA2XSY 12/20/24 kV cables.....	88
Table 13. Representative product G42-201-2071-A.....	89
Table 14. Components of the product G42-201-2075.....	89
Table 15. Data of component AIUK-185-32x2.80.....	89
Table 16. Data for CuŽ-M-7x0.82 component.....	89
Table 17. Representative product G42-101-1510.....	90
Table 18. Components of the product G42-101-1510.....	90
Table 19. Data of component CuUK-50-7x3.05.....	90
Table 20. Data of component CuŽ-M-6x0.85.....	90
Table 21. Data of component CuŽ-M-7x0.85.....	90
Table 22. Chosen representative products Low Voltage (up to 1 kV).....	91
Table 23. Construction data on cables N2XY, NA2XY, N2X2Y, NA2X2Y.....	92
Table 24. Representative product G42-202-0126-B.....	92
Table 25. Components of the product G42-202-0126-B.....	93
Table 26. Data of component AIUS90-70-19x2.15.....	93
Table 27. Data of component CuŽ-JV-1.33.....	93
Table 28. Representative product G40-102-1880-B.....	93
Table 29. Components of the product G40-102-1880-B.....	93

Table 30. Data of component CuUK-300-55x2.65	94
Table 31. Machines involved	94
Table 32. Key capabilities and benefits of Siemens (Tecnomatix) Plant Simulation	96
Table 33. Increase in the number of orders per year	104
Table 34. Batch size for each product, kilometers	105
Table 35. Orders (production quantities) and transports (material flow quantification) for each component	109
Table 36. Flow Matrix (number of transports between different machines)	110
Table 37. Material flow from/to different machines	110
Table 38. Matrix of the total time needed for transportation, hours/year	113
Table 39. Parameters of the material handling system.....	113
Table 40. Cumulated statistics for the parts deleted by the drain – Alternative 1	115
Table 41: Production quantities Alternative 2.....	118
Table 42. Cumulated statistics of the parts deleted by the drain - Alternative 2	119
Table 43. Production quantities alternative 3	122
Table 44. Cumulated Statistics of the parts deleted by the drain – Alternative 3	123
Table 45. Comparison of the utilization machines between different alternatives	126
Table 46. Increase of the numbers of order for the fourth alternative	127
Table 47. Cumulated statistics of the part deleted by the drain - alternative 4	128
Table 48: Comparison between the chosen solution and the actual situation	130

LIST OF BOOKMARKS OF PHYSICAL VARIABLES AND MEASUREMENT UNITS

Bookmark	Measurement unit	Name/Description
Tsetup	Hours/set-up	Preparation (set-up) time for the machine
Tproc	Hours/batch	Processing time
Ttot	Hours/batch	Total production time
Li	Hours	Load time
Uj	Hours	Unload time
tij	Hours	Transportation time
dij	meters	Distance between machine i and j

1. THE CABLE BUSINESS AND THE PRODUCTS

1.1. Electrical principles and conductors

Materials can be classified in relation to their capacity to conduct electricity: it is possible to individuate conductors, semiconductors and insulators.

Conductors, such as copper and aluminum, are those materials that present a large number of free electrons that move easily and offer a little opposition to the passage of the electric current. On the contrary, insulators, such as rubber and plastic, offer high resistance when a voltage is applied because of their atomic structure composed by few free electrons.

Semiconductors, for example silicon and germanium, can conduct electricity, but their properties are similar to those of conductors only over a limited temperature range.

Light can be considered as an electromagnetic wave that can pass through some materials more easily than some others, while sometimes it is blocked; when light passes through a material, it is attenuated. Materials that allow the passage of light are light conductors, called fiber optic cables.

In general, both electrical conductors and fiber optic cables are used to carry information, and fiber optic cables have higher performance for this purpose because of the higher frequency. However, only electrical conductors can be used to transmit power. [1]

Electrical conductors can be grouped in solid and stranded (Figure 1.). A solid conductor is composed by a single strand of hard-drawn or soft-drawn wire and they are mainly used for lighting, service, control and grounding systems. Hard-drawn conductors are wires that are mechanically drawn after being cooled from the heating process and they are characterized by

high tensile strength and low elongation under stress. On the contrary, soft-drawn conductors are treated with heat in order to remove internal stress and to obtain the greatest elongation under stress. [1]

Stranded conductors are composed by solid wires twisted together in a common bundle or individual groups. They have high flexibility and so they are mainly used to make connections, such as terminating at device connections and terminal bonds. [1]



Figure 1. Solid and stranded conductors

Nowadays the mainly conductor materials used are Aluminum and Copper, especially because of their reasonable costs and good conductive properties. Copper is a better conductor, in fact aluminum has 61 % of the conductivity of copper. Other conductors are silver and gold. Silver is the most electrically conductive element, and it has also the highest thermal conductivity; it is commonly used for contacts or plated onto some conductors, but because of the higher cost, it is less used than copper. Gold is almost as good as copper regarding conductivity, and it is extremely resistant to corrosion. It is very expensive, so it is used for specialized applications, such as very fine wires or connectors. [1]

Copper conductors show the advantages of having a lower resistance than aluminum conductors; it means that they can pass the current without creating excess heat, but they are more expensive and heavier. Aluminum conductors are long, straight and cheap but they are not so good as copper because of the higher resistance that worsens terminating characteristics. They need

special care when terminating, in fact an anti-oxidizing paste must be used because aluminum oxidize when exposed to the air, also it can expand and contract because of changes in temperature. [2]

Moreover, it is possible to get very small stranded copper cable, while aluminum cable is only available at nominal cross-sectional areas of at least 10 mm^2 , and the individual strands are very thick compared to those in the equivalently sized copper cable. It means that the finest aluminum available are stiffer than that made of copper and so it is important to take into account some additional costs for aluminum due to the effort involved in installing the less pliable aluminum cables.

One of the most important problem for copper and silver plating is the presence of Hydrogen Sulfide (H_2S) in the atmosphere; it is possible to observe two processes: general corrosion of the silver and creep corrosion of Cu. Tin plating is a practical solution to the H_2S corrosion, so tinned copper have being more and more used for wiring and flexible cables. [3]

Table 1. Physical properties of metals used in cables (20 °C)

<i>Property</i>	<i>Copper</i>	<i>Aluminium</i>
Density (kg/m^3)	8890	2703
Resistivity ($\mu\Omega \text{ m}$)	0.01724	0.02826
Res.-temperature coefficient (per °C)	0.0039	0.0040
Thermal expansion coefficient (per °C)	17×10^{-6}	23×10^{-6}
Melting point (°C)	1083	659
Thermal conductivity (W/m K)	380	240
Ultimate tensile strength		
soft temper (MN/m^2)	225	70–90
$\frac{3}{4}\text{H}$ to H (MN/m^2)	—	125–205
Elastic modulus (GN/m^2)	260	140
Hardness		
soft (DPHN)	50	20–25
$\frac{3}{4}\text{H}$ to H (DPHN)	—	30–40
Stress fatigue endurance limit (MN/m^2)	± 65	± 40

1.2. Types of cables

A power cable is an assembly of two or more electrical conductors, usually held together with an overall sheath and used for the transmission of electrical power. It is possible to install power cables within buildings, buried in the ground, run overhead or exposed, while flexible cables are mainly used for mobile devices, and machinery. [4]

Cables are usually classified according to their voltage as:

- Low voltage cables, up to and including 1000 V

- Medium voltage cables, starting 2000 V up and including 33 kV
- High voltage cables, above 33 kV up to and including 150 kV
- Extra high voltage cables, 220 kV, 400 kV, 500 kV. [4]

Concerning the main cable components, it is possible to individuate a general structure composed by (Figure 2.):

- Core or conductors: a cable may have one or more conductors depending on the use for which is made. The conductors are mainly tinned copper or aluminum and are usually stranded in order to provide flexibility to the cable.
- Insulation: it is used to protect the core; the thickness of the layer depends on the voltage to be withstood by the cable. The materials mostly used are impregnated paper or rubber mineral compound.
- Metallic sheath: it is used to protect cable from moisture, gases, damaging liquids in the soil and atmosphere and the mostly common materials used for sheath are lead or aluminum.
- Bedding: it is applied over the metallic sheath in order to avoid corrosion and mechanical injury; the layer of bedding usually consists in fibrous materials like jute or hessian tape.
- Armouring: it is the layer over the bedding consists of galvanized steel or steel tape, which may not be present for some cables. The aim is to protect the cable from mechanical injury while laying it and during the course of handling.
- Serving: it consists of fibrous materials, such as jute, that protect the armouring from atmosphere conditions. [4]

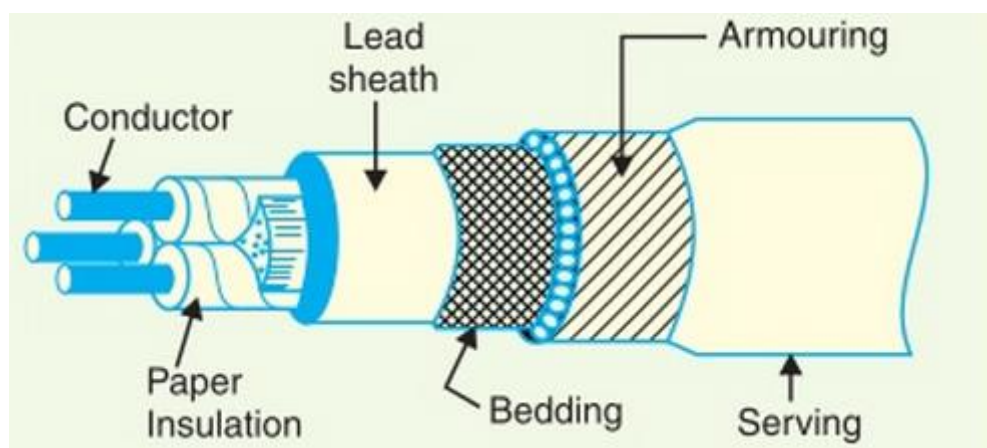


Figure 2. General structure (main components) of a cable

1.3. The insulation

In general, the successful operation of a cable is largely influenced by the choice of the insulating material, which depends on the purpose for which the cable is required and the quality of insulation to be aimed at.

It is possible to individuate some properties for insulating materials:

- High insulation resistance to avoid leakage current
- High dielectric strength to avoid electrical breakdown of the cable
- High mechanical strength to withstand the mechanical handling of cables
- Non-hygroscopic, without the absorption of moisture from air or soil
- Non-inflammable
- Low cost, so as to make the underground system a viable proposition
- Unaffected by acids and alkalies to avoid any chemical action. [4]

It is not possible to find an ideal insulation, so a compromise has to be found between performance and costs. Some of the mostly used materials are thermoplastic or elastomeric materials, and impregnated papers.

An elastomeric material is one that can return rapidly to its initial dimensions and shape after deformation at room temperature by a weak stress. Under such conditions, a thermoplastic material shows permanent deformation. [5]

Conventional elastomeric need to be cross-linked by vulcanization and the mostly common materials are natural rubber (NR), ethylene propylene rubber (EPR), polychloroprene (PCP), chlorosulphonated polyethylene (CSP) and silicone rubber (SR).

Conventional thermoplastic materials are polyvinyl chloride (PVC), polyethylene (PE), polypropylene (PP).

PVC is the most usual insulant for wiring cables because of its cost advantage and the good performance. It is obtained from the polymerization of acetylene and it is in the form of a white powder, then it is compounded with plasticizers to be used as a cable insulator. PVC has a good dielectric strength, high insulation resistance and mechanical toughness over a wide range of temperature; it is also inert to many alkalies and acids and so it can be used in extreme environmental conditions.

Where electrical properties are paramount, for example for the radiofrequency cables, polyethylene is the preferred insulant. Some of advantages of PE are low permittivity (low dielectric constant), low tan delta (low dielectric loss), and high initial dielectric strength.

The main advantage of elastomeric compounds is that they can operate at higher temperature than PVC: EPR can operate at 85 °C continuously, while SR at 150 °C. Moreover, they are the first choice when flexibility is required; the main applications for these types of material are flexible cords for domestic flatirons and flexible trailing cables for mines.

In distribution field PVC is also the mostly material used, and cross-linked polyethylene is preferred than EPR, because in this case flexibility is not so much important. XLPE comprises polyethylene, an antioxidant and a cross-linking agent. Nowadays, the most common way to obtain the cross-linking is to mix an organic peroxide with the PE and to extrude the insulate conductor into a large tube containing steam under high pressure. [5]

The impregnated paper consists of chemically pulped paper made from wood chippings and impregnated with some compounds such as paraffinic or naphthenic materials. [4]

The primary advantages are the low cost, the low capacitance, the high dielectric strength and high insulation resistance. However, paper is hygroscopic and absorbs moisture that lowers the insulation resistance of the cable. For this reason, paper insulation is mostly used for underground cable and where the cable route has a few joints, because the costs increase for special precautions to avoid moisture at joints.

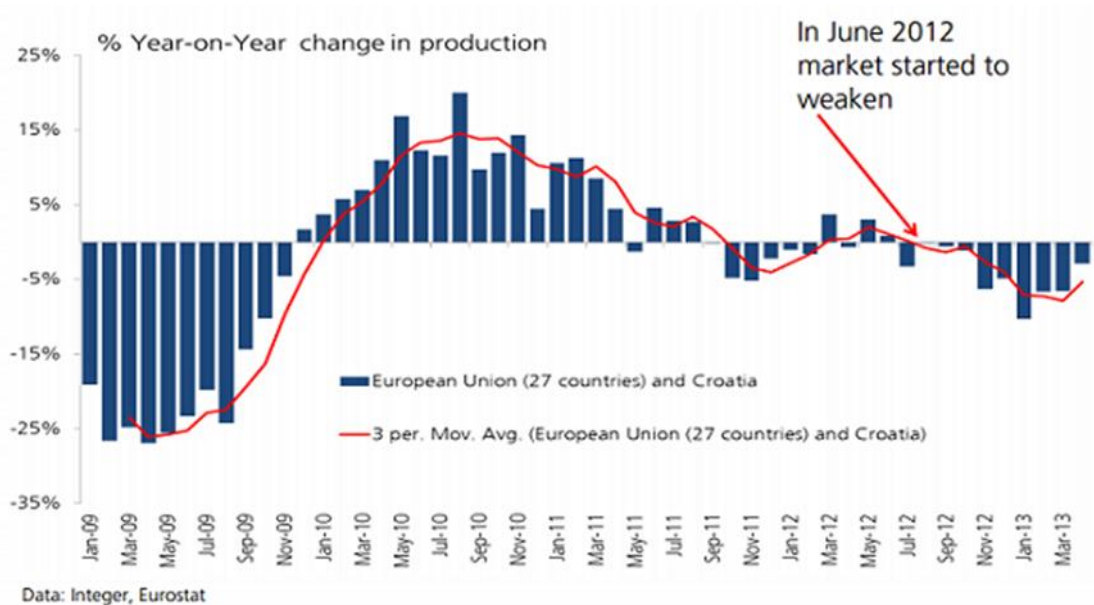
Table 2. Comparison of cable insulating materials

Paper/cellulose	Polyethylene PE	XLPE	EPR
Natural	Synthetic	Synthetic	Synthetic
More polar, medium losses	Less polar, low losses	Less polar, low losses	Losses due to additives
Fibrils	Not-fibril	Not-fibril	Not-fibril
Not crosslinked	Not crosslinked	Crosslinked	Crosslinked
No thermal expansion on heating	Significant thermal expansion	Same thermal expansion as PE	Slight thermal expansion
Thermal degradation via cleavage at weak link	Degrades at weak links	Degrades at weak links	Same as XLPE
Chains linear	Chairs branched	Chairs branched, crosslinked	Chairs branched, crosslinked

1.4. Cable business and market

The European cable business saw impressive growth from 2004 until 2008 thanks especially to the technological development¹. Then, due to the impact of the economic slowdown, the market experienced a decline in the growth rate from 2009. However, most companies bounced back from the financial crisis by virtue of capital spending and investments in industries worldwide. The economic recession showed its effect on the transmission and distribution sector and due to the ongoing crisis in many countries, the pricing of the cable has become a competitive parameter and the competition between existing players has significantly increased. [6]

In order to survive in the market and face the competition, companies are adopting strategies such as acquisitions, exploration of new markets, improvements in research and development, focus on customers. As a result, cable manufacturers need to be agile enough to respond quickly to changing levels of the demand.



X-axis: period 2009-2013

Y-axis: change in production volumes

Figure 3. EU cable industry hit by reduction in economic growth and lower fixed investment

In general, the main reason why Europeans managed to fend off Asian rivals is that around the 70 % of cable production costs are raw materials (especially copper and aluminum) which has

¹ Innovation in energy transmission and distribution, such as Smart Grid, or information technology development that has encouraged the manufacture of fiber optic cables.

the same cost all over the world. The biggest advantage of Asia is the lower labor costs, but this is such an irrelevant element, because of the labor accounts for a mere 10 % of overall costs. [7] This means that the cost of copper and aluminum is a critical factor that needs to be considered and carefully managed by cable industries. The main issue is that the costs of these raw materials are strongly fluctuating, and it is important for industries trying to implement strategies to handle this volatility for a short-term growth and a long-term advantage. This should be a priority for companies with a significant raw material exposure, particularly manufacturers and those in the process industries. [7]



Figure 4. Price of copper from 1989 to 2014



Figure 5. Price of aluminum from 1989 to 2014

A focus on the Eastern Europe (Figure 6.) shows that the cable sector is becoming one of the most important growth markets in Europe. Yet, the only companies with operations in more than one country are Prysmian Group (Hungary, Slovakia and Romania), NKT Cables (Poland and the Czech Republic), and Wilms Group (Czech Republic, Romania). [6]

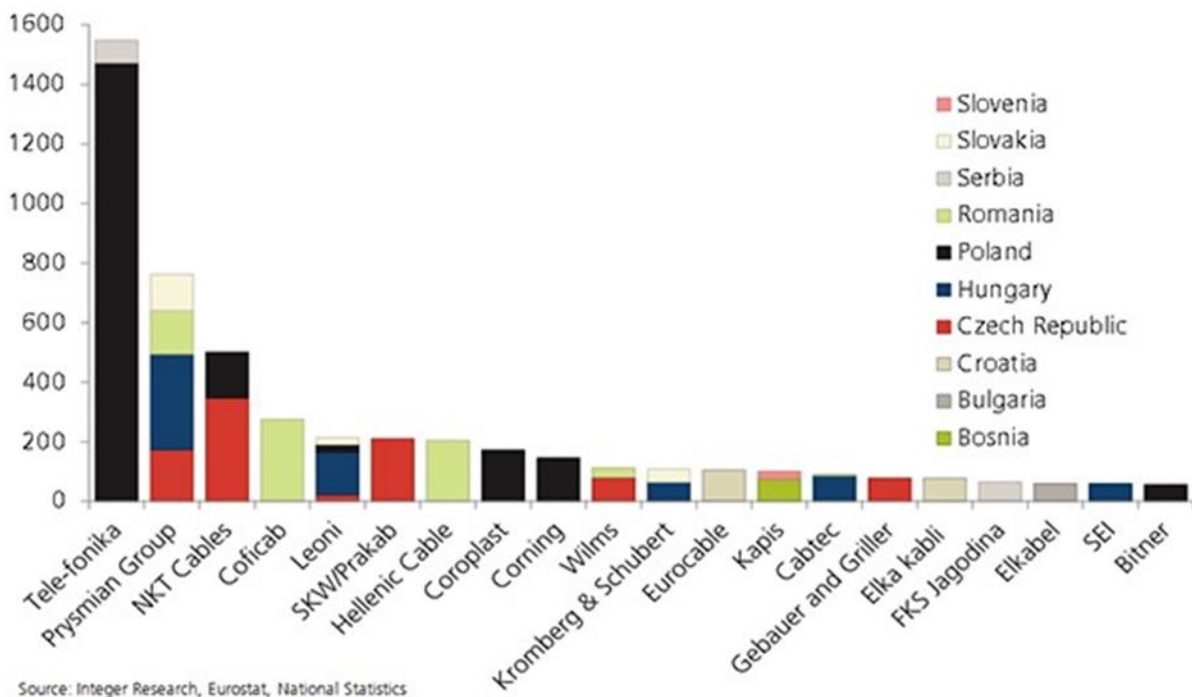


Figure 6. Eastern Europe cable market

Major cable manufacturers in the Eastern Europe are:

- NKT has consolidated its operations, following the acquisition of Kablo Electro
- Hellenic Cables has a major stake in the Romanian cable sector
- Coficab, part of Elloumi Group, has operations in Romania
- SKW/Prakab has cable-manufacturing plants in Austria, the Czech Republic, Slovakia and now Ukraine
- Kromberg & Schubert has a significant footprint, with plants in Romania, Hungary and Slovakia.
- Cabtec has plants in Hungary, Romania and Slovakia.

Specialist participants, dedicated to the manufacturing of cables and conductor for the automotive industry are:

- Sumitomo Electric has a network of wiring harness operations in Eastern Europe, but a smaller quantity in the cable sector
- Leoni has a number of specialist automotive wire producing plants in Slovakia, Hungary and Poland, and now in Serbia.

New entrants:

- Cablex, with operations in Poland, Serbia and Slovenia. [6]

Following, the focus has been moved in the Western Europe making a list of the main cable manufacturers (Figure 7.). A particular section (Figure 8.) is dedicated to the Southern European market, including Italy, which has encountered quite some difficulties during the latest years.

Even though the differences between geographical areas, some common aspects in cable business and markets can be individuated and analyzed.

AUSTRIA		Telephone Cables (G.E.C.)
Gebauer & Griller		S.T.C.
Felten & Guilleaume		A.E.I. Cables
Kabel & Draht Werke		Pirelli General
BELGIUM		Raychem
Opticable		Folhergill & Harvey
DANEMARK		ITALY
N.K.T.		Pirelli
FEDERAL REPUBLIC OF GERMANY		CEAT (Pirelli)
Felten & Guilleaume (Philips)		Manuli Cavi
SEL (ITT)		Nuove Fulgor Cavi
Monette		Fabrica Milanese di Conduttori F.M.C.
E.I.W.		Pasta (Pirelli)
Reinshagen Kabelwerke (G.M.)		Teleco Cavi (GCR)
A.E.G. Kabelwerke		Intercond
Siemens		Tratos Cavi
Berkenhoff & Drebes (Thyssen Draht)		NEDERLAND
Kabelmetal (Cables de Lyon)		NKF (Philips)
Spiralglass Kabel		Pope (Philips)
LAPP		De Regt Cables
FINLAND		Twentsche Kabelfabrieken
NOKIA		DRAKA (Philips)
Helikama Kaapeli		NORWAY
Kaapeliteollisuus Oy		STK (ITT)
FRANCE		NORSK KABEL
L.T.T. (Cables de Lyon)		PORTUGAL
SATCable (SAT)		Cabelle
SILEC (SAT)		Celcat (BICC)
Cables de Lyon (CGE)		Avila
Précâble (Pirelli)		SPAIN
ACOME		Cables de Comunicaciones
GORSE (Cables de Lyon)		Standard Electrica (ITT)
Fileca		SWEDEN
Filotex (CGE-Cables de Lyon)		Sieverts
Cordons & Equipements (CEAT)		ASEA Kabel
GREAT-BRITAIN		SWITZERLAND
Sterling Cables		Cabloptic
B.I.C.C.		Huber & Suhner
Pilkington		Daetwyler

Figure 7. Western Europe cable manufacturers

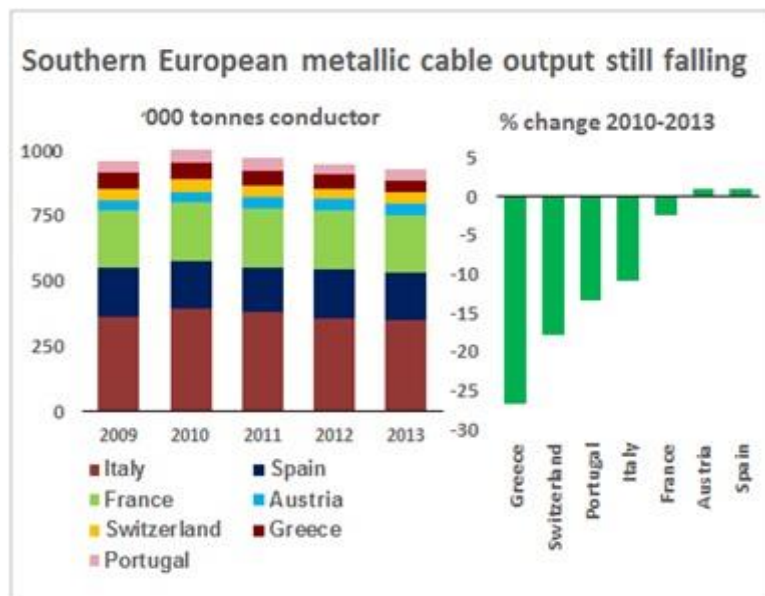


Figure 8. Southern European Market

During the last years, there has been a diffused phenomenon of consolidation in industries consisting in the merger and acquisition of many smaller companies into much larger ones; this process allowed producers to expand global reach and achieve benefits of scale. Many companies have decided to compete by pursuing a differentiation strategy and they have refocused their portfolios with the manufacture of personalized cables for specific markets, often driven by local demand. It means that the technology in the industry has become more and more important and it is constantly developed through innovation of resins and additives, particularly for flame retardant applications and the use of LSF0H (low smoke and fume, zero halogen) polymers. PVC remains the main polymer material used in cable production in Europe and the world, with 87 % of European extrusion sites processing the material at their plant.

The economic environment in 2014 was characterized by several geopolitical tensions in some areas of the world with consequent slowdown in emerging market economies (China, Brazil and Russia), but some recovery in other country (North America, United Kingdom and Germany). Global demand for cables grew slightly in 2014, mainly thanks to high-growth regions, such as the Middle Est, and to the strongly recovering countries like the United Kingdom and Eastern Europe (except Russia). In the other European countries, like Italy, France and Germany, market continued to be stagnant, not only because of the construction sector crisis, but also for persistently energy consumption that made flat the demand for energy cable and systems. [9]

In particular, the cable demand grew in some market segments like optical cables and those for renewable energy (high and extra high voltage submarine cables for interconnections and offshore wind farm connections in Europe). Demand for renewable energy cables was higher thanks to the government incentives, while demand for optical fiber cables grew especially in countries like Italy, Spain, France and United Kingdom. There was also a slight recovery in building wire demand, but only in Asia Pacific and Northern Europe. On the other hand, demand declined for power distribution cables, especially in Europe, special cables and copper telecommunication cables. [9]

Since January 2015 a massive shutdowns involving manufacturers of polypropylene and high and low-density polyethylene has led to an extraordinary cost increases of these materials. According to data Unionplast (Association of Plastic Rubber Federation of Confindustria), in the period from January until May 2015 the increase in the cost of materials of polyethylene (LDPE and LLDPE) was more than 35 %, while the increase in PVC prices was around 11 %. This is a big alarm especially for country like Italy characterized by a strong dependence on foreign concerning the supplying of raw materials, but also for all the Europe. The impact of this

situation can only be negative for the development of the Italian industry of cables and wires, which closed 2014 down 4,5 %. [7]

1.5. Market challenge for the future

Renewable energy will represent the most important source of electricity growth over the next five years, thanks to decreasing costs and driven by aggressive expansion in emerging economies. In order to mitigate the climate change and to enhance energy security, the IEA² report demands governments to pursue a greater deployment by implementing policies that encourage the use of renewable resources instead of fossil fuels to produce electricity. The direct consequence is that cable manufacturers can take advantage by this growth market opportunity, in fact wires and cables are key components in any solar or wind installation. So many companies started for example to produce submarine cable, in order to seize on the offshore wind farms market. In fact, forecasts for future predict an increasing demand of the amount of wire and cable, because wind farms will probably be built from 30 miles to 100 miles offshore, by far than the 10 miles of nowadays.

Solar power also represents an opportunity for cable industries, and a typical solar installation requires four-to-five times the amount of cable as a wind farm; this means that many companies are developing products specifically for solar applications (for example solar cables and photovoltaic wire).

The report "Medium Voltage Cable Market by Overhead (Conductors, Fittings & Fixtures, Others), by Underground & Submarine (MI Cables, XI Cables, Cable Terminations, Cable Joints, Others), by End-User (Infrastructure, Renewables, Industrial) and by Region - Global Forecast to 2020" [8] defines and segments the global Medium Voltage Cable Market with an analysis and forecast of the market size. The Medium Voltage Cable Market is expected to grow from an estimated USD 35,2 Billion in 2015 to USD 48,8 Billion by 2020, at a CAGR of 6,8 % and the increasing demand for medium voltage cables is driven by the diffusion of renewable energy production. They can be installed overhead, underground as well as underwater with different related accessories, such as cable joints and terminations. [8]

Moreover, another crucial element to consider is the diffusion of Smart Grid technologies, which encourage an efficient use of the energy by handling the integration of large amounts of

² International Energy Agency.

distributed generation of renewable sources. Large-scale implementation of energy network technologies can represent a challenge for cable market, because of the increasing demand and for the high reliability required. In fact, cables and accessories in the smart grid architecture play an important role: this is because the usage of adequate and advanced cable technologies can enhance grid reliability and efficiency. Therefore, it is necessary to prevent blackouts and reduce maintenance costs, because every failure of a major power cable causes huge costs, with considerable effects on the transmission grid, and may take several days/week to repair or several months/year if it is under the sea.

2. ELKA FACTORY

2.1. Description of ELKA

ELKA, founded in Zagreb in 1927, is one of the leader factories in cable production in the market of Croatia, Bosnia and Herzegovina, and Slovenia. In those more than 80 years, ELKA has produced a large number of quality products and expanded his markets. It has also consolidated professional skills and operational capability that make it one of the major producer of electrical cables in the Eastern Europe.

The Vision of ELKA is to remain a cable company, interested in vertical expansion by designing new products, and horizontal expansion by increasing the customization of the existing products, always with the goal of increase the competitiveness. ELKA is focused on offering high quality products and services by giving importance to the customer satisfaction and pursuing engineering and flexibility with the orientation to objectives and results.

The strategic goals are keeping a leader position in Croatian, Bosnian and Slovenian markets, trying to expand their business in the Western parts of Europe and catching the opportunity of entering in new markets. [10]

Figure 9. shows the 2013 percentage of sales of ELKA in the different countries.

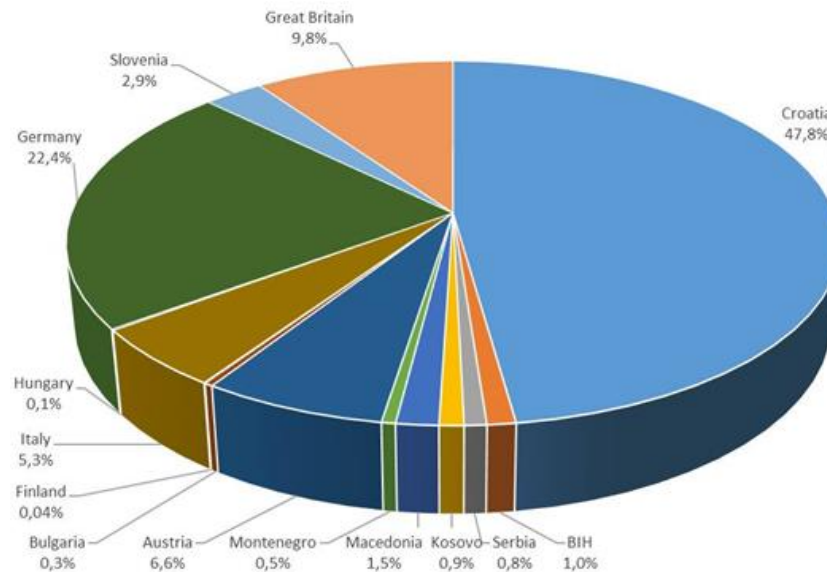


Figure 9. ELKA: percentage of sales in different countries, 2013

ELKA is organized with a functional structure with different separated departments, such as Production, Commercial, Finance and Research and Development, each one managed by a functional responsible. Nowadays ELKA has around 285 employees. The central factory in Zagreb and the plant in Zadar have an area of 188 000 m², of which 68 000 m² of constructed ground. The annual capacities can support a production of 25 000 tons of different products.

ELKA produces also XLPE and elastomer insulation compounds for the insulation of low voltage and medium voltage power cables, and it has got a proper development center and test laboratories for materials and cables with up to date equipment and high qualified staff, what guarantees a high quality of final products, materials and cables.

Thanks to the collaboration between ELKA and KONCAR distribution and special transformers, ELKAKON started working in December 2003. The production capacity of ELKAKON is 1150 tons per years and the company is the only producer of rounds and profile industrial conductors in Croatia. Around 70 % of the ELKAKON products is sold in Croatia and the other 30 % exported in other country.

2.2. Product mix

ELKA offers a large number of different products with specific characteristics at high quality level:

- POWER CABLES
 - 1 kV with PVC and XLPE (cross-linked polyethylene)
 - 6 kV to 36 kV with XPLE and EPDM (Ethylene-Propylene Diene Monomer) insulation
 - 1 kV to 36 kV self-supporting cables with XLPE insulation
 - 36 kV to 132 kV High voltage
- FLEXIBLE THERMOPLASTIC INSULATED WIRING CABLES AND WIRES
 - Power cable and wires
 - Automotive wires
- FLEXIBLE RUBBER INSULATED WIRING CABLES AND WIRES
- SHIPBOARD CABLES
 - With EPDM insulation and CR sheath
 - Flame-retardant halogen free cable
 - Fire-resistant halogen free cable
- CABLE AND CONNECTORS FOR AIRPORT INSTALLATIONS
- TELECOMUNICATION CABLES
 - Telephone cables with PE insulation
 - Telephone cables with PVC insulation
- FIBRE OPTIC CABLE
- CONTROL, INSTRUMENT AND COMPUTER CABLES
 - Control cables with PVC insulation for voltage up to 1 kV
 - Instrument cable with PE and XLPE insulation and PVC sheath
 - Cat.5 LAN cable with fiber optic and Cu conductor
- MINING CABLES
- WELDING CABLES
- SPECIAL CABLE AND WIRES
 - operating temperature +70 °C up to 160 °C
- ALUMINIUM, AL-STEEL AND AL-ALLOY ROPES

- OPTICALPOWER GROUND WIRE
- STEEL ROPES AND SLING FOR CRANES, SHIPS AND OTHER APPLICATION
- INSULATION MATERIAL
 - Rubber compounds
 - XLPE (cross-linked polyethylene)
 - Halogen free flame-retardant polyolefin
 - PVC.

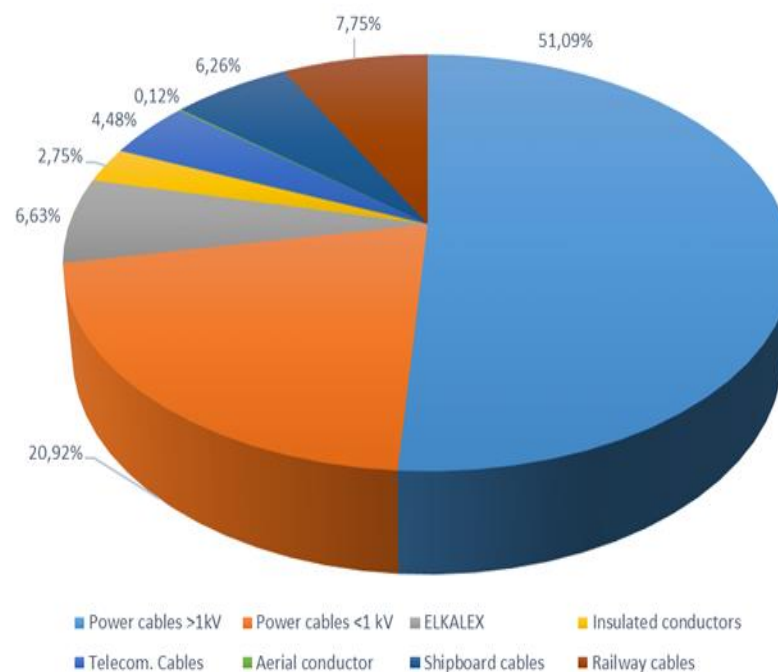


Figure 10. Percentage of ELKA cable sales in year 2013.

2.2.1. High-voltage power cables

Nowadays this kind of cables are more and more used in all over the world especially for electric power transmission at high voltage in densely populated areas. The main reasons for using them include efficiency (the maintenance is cheaper, smaller transmission losses, more reliability), safety for people, ecological reasons. High voltage cables include a conductor and the insulation, and they are suitable for being used underground or underwater. The XLPE (cross-linked polyethylene) represents the most used insulation and it is obtained by using the most recent technology of triple extrusion. It is better to use XLPE instead of PVC because the cross-linking

inhibits the movement of molecules: this improves the thermal stability and consequently the current rating is higher than that of PVC.

For the high-voltage power cables, it is possible to introduce a common symbology:

- 2X is the designation for XLPE insulation
- S is the designation for the copper screen
- Y is the designation for a layer of PVC
- A is the designation for Aluminum
- - (no symbol) is for copper conductors
- (F)2Y is the designation for longitudinal watertight construction with PE layers
- (FL)2Y is the designation for longitudinal and transversal watertight with A/PE layers.

The main high voltage cables produced by ELKA are:

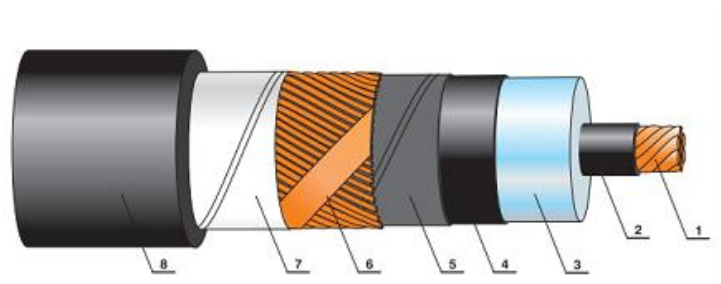
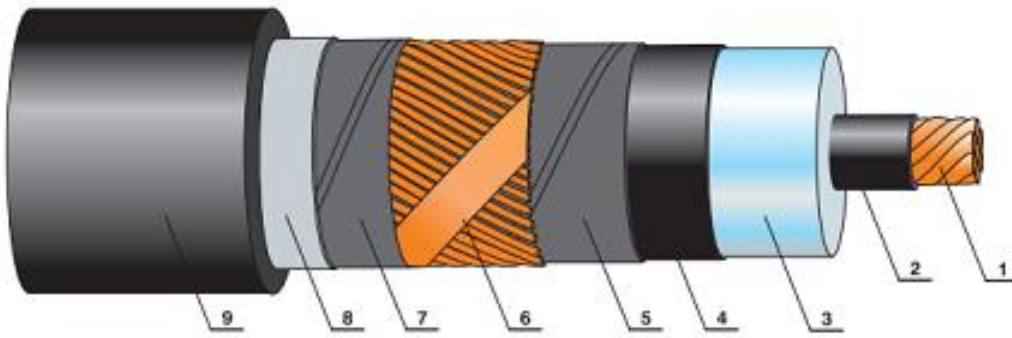


Figure 11. 2XS(F)2Y, A2XS(F)2Y

- 1- Conductor: copper or aluminum compacted or segment rope of class 2;
- 2- Conductor screen: extruded semi-conductive XLPE;
- 3- Insulation: XLPE;
- 4- Insulation screen: extruded semi-conductive XLPE
- 5- Separator: swelling tape, semi-conductive
- 6- Metal screen: copper wires and counter-helix of copper tape
- 7- Separator: swelling tape
- 8- Sheath: black HDPE.



- 1 Conductor: Cu or Al compacted or segment rope, class 2
- 2 Conductor screen: extruded semi-conductive XLPE
- 3 Insulation: XLPE
- 4 Insulation screen: extruded semi-conductive XLPE
- 5 Separator: swelling tape, semi-conductive
- 6 Metal screen: Cu wires and counter helix of copper tape
- 7 Separator: swelling tape, semi-conductive
- 8 Laminated sheath: Al or Cu tape with copolymer
- 9 External sheath: black HDPE

Technical aspects:

Nominal voltage: 64/110 kV

highest network voltage: 123 kV

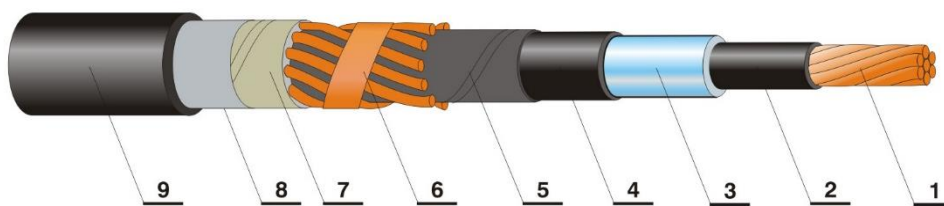
standards: IEC 60840; HRN HD 632

old mark: XH(A)E 49, XH(A)E 49-A

Figure 12. 2XS(FL)2Y, A2XS(FL)2Y

2.2.2. Medium voltage power cables

Medium voltage cables with XLPE insulation are manufactured with up-to-date technology. Cross-linking of insulation is obtained by dry cured vulcanization procedure in a neutral nitrogen gas. This increases the resistance of insulation and offer an high quality connection between insulation and conductive layers.



- 1 Conductor: Al or Cu rope, compacted
- 2 Conductor screen: semi-conductive layer over conductor
- 3 Insulation: XLPE
- 4 Insulation screen: semi-conductive layer over insulation
- 5 Separator: swelling tape, semi-conductive
- 6 Electric protection/screen: Cu wires and Cu tape
- 7 Separator: swelling tape
- 8 Laminated sheath: Al tape with copolymer
- 9 External sheath: PE-HD

Technical data:

Nominal voltage: 12/20, 18/30, 20,8/36 kV

Max network voltage: 24, 36, 42 kV

Test voltage: 30, 45, 52 kV

Standard: IEC 60 502-2; HRN HD 620 S2 Part 10C; DIN VDE 0276T 620

Figure 13. N2XS(FL)2Y, NA2XS(FL)2Y

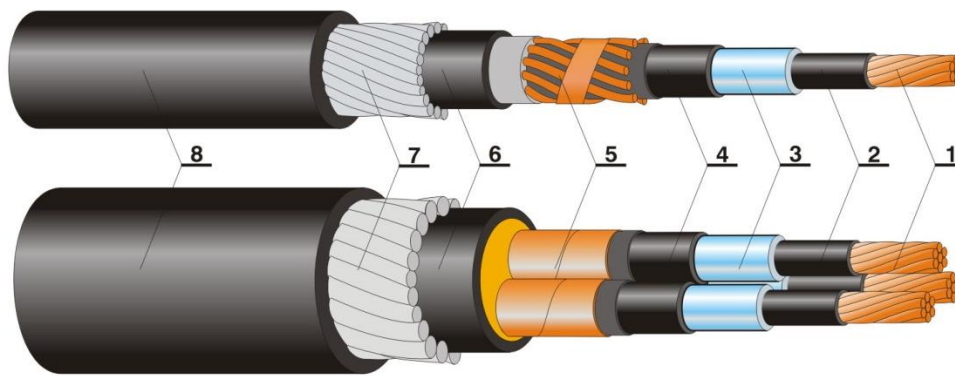


Figure 14. XHE 46/29, XHE 49/24

Submarine power cables with XLPE insulation:

- Single core with armour of aluminum alloy AlMgSi in watertight construction
- Three core with armour of steel wires in watertight construction

Cable structure:

- 1- Conductor: Al or Cu rope, compacted
- 2- Conductor screen: semi-conductive layer over conductor
- 3- Insulation: XLPE
- 4- Insulation screen: semi-conductive layer over insulation
- 5- Electric protection/screen: made of Cu wires, watertight construction
- 6- Sheath: semi-conductive PE
- 7- Additional electric protection: of tinned copper wires (1 or 2 layers).

2.2.3. Low voltage cables

This category includes cables with PVC insulation and sheath, cables with flame-retardant PVC insulation and sheath, cables with XLPE insulation and PVC or PE sheath, cables with flame-retardant XLPE insulation and flame-retardant polyolefin halogen-free sheath, self-supporting cable bundle with XLPE insulation or flame-retardant XLPE insulation. The conductors of this kind of cable are made of copper or aluminum, while the insulation consists of the PVC or XLPE compound layer. As regards flame-retardant halogen insulation materials, they have particular

characteristic such as a larger quantity of oxygen, measured by LOI (larger oxygen index), and high temperature, expressed by TI (temperature index). The flame-retardant halogen free XLPE halogen materials have the peculiarity that they develop smoke not toxicant or corrosive during the combustion. The color of the sheath explains the cable type, in particular black for standard cables, gray for flame-retardant halogen-free cables, blue for flame-retardant halogen cable.

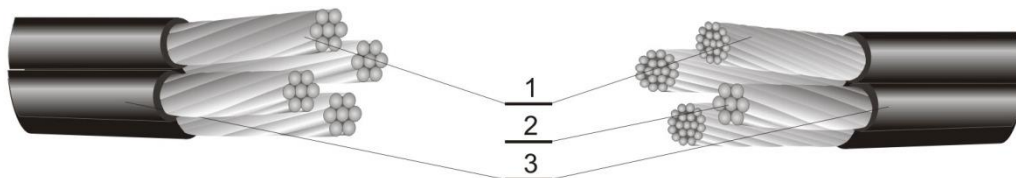


Figure 15. FR-N1XD4-AR, FR-N1XD9-AR, FR-NFA2X

- 1- Phase conductor: compacted round shaped Al rope of 16, 25, 35, 50 and 70 mm².
- 2- Neutral conductor: compacted round shaped rope of aluminum alloy AlMgSi of 70 mm² or 54,6 mm² or aluminum alloy AlMg 1 (1 % magnesium) of 71,5 mm² nominal cross section.
- 3- Insulation: XLPE black compound.

The commercial code is ELKALEX-1; it is a self-supporting insulated cable typically used for distributive low-voltage air networks in urban, suburban and rural areas, for air household connections, for supply of remote facilities and villages.

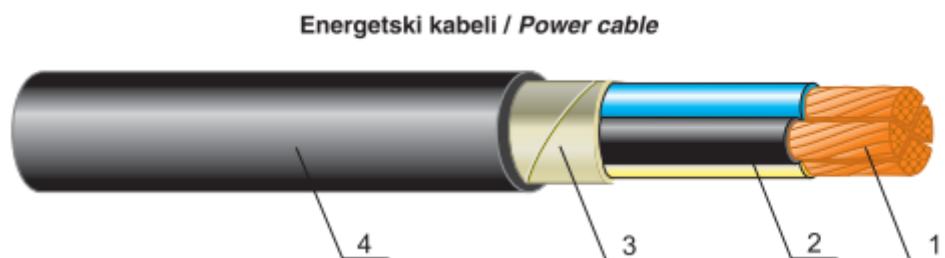


Figure 16. NYY-J 4x240 SM

Power cable with PVC insulation and sheath:

- $n \times q$ (n stands for number of cores in cable; q stands for cross section of conductor in mm²)

- J is the designation for cable with protective conductor (yellow core)
- SM is the designation for multi-wire sector conductor.

Main components:

- 1- Conductor
- 2- Insulation of PVC compounds
- 3- Filling obtained by extruded elastomer or PVC compound or wrapped thermoplastic tapes
- 4- Sheath of PVC compounds.

2.2.4. Telecommunication cables

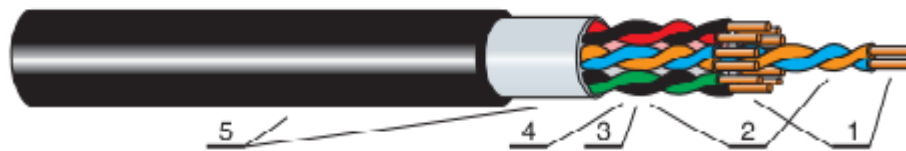
The overall diffusion and development of telecommunications imposes the construction of high quality cables based on the latest technologies and modern production, submitted to detailed tests and quality check. ELKA provides high number of telecommunication cables, for the needs of HPT³ and also for railways, industry, shipbuilding and mining, broadcasting and television. As regards the insulation and sheath, the thermoplastic materials most used are polyethylene (PE), polyvinyl chloride (PVC), and polyamide (PA12). After being produced, cables are wound on wooden drums if without segments, or metal drums if with segment, or on coils of standard lengths.

An example of telecommunication cable is the multicore symmetrical pair cable for broadband digital communication networks, with the mark:

TK59-50xDSL-30Mhz 200x2x0.5 GM –TK= low frequency subscriber cable

- 59 = insulation of foamed polyethylene, laminated PE sheath
- Three groups of number, connected by “X”; the first group stands for the number of basic elements in the cable, the second group for the way of stranding of basic elements, the third for cable conductor diameter
- G = cable stranded in group
- M = cable filled with special compound.

³ Croatian Post and Telecommunications



- 1- Conductors: softly annealed copper of diameter 0,4, 0,5, 0,6 mm
- 2- Insulation: foamed polyethylene with a thin layer of solid polyethylene (foam skin)
- 3- Stranding elements: pairs
- 4- Cable core: group (G) stranded filling with filled compounds (M)
- 5- Sheath: laminated, aluminum tape, both sides coated with copolymer ethylene layer in form of tube with overlap, firmly and permanently glued to black colored polyethylene sheath.

Figure 17. TK59-50xDSL-30Mhz 200x2x0.5 GM

2.3. Technology

Technology is the collection of techniques, skills, methods and processes used in the production of goods and services. Therefore, it can be represented by the knowledge of processes and techniques or it can be embedded in machines, computers, and devices.

Nowadays it is difficult to survive in a dynamic market and the only way to reach a competitive advantage is through the deployment and use of idiosyncratic, valuable and inimitable resources and capabilities. Capability building refers to the capacity of firms to build unique competences and capabilities that can leverage their resources; so human, business and information resources play an essential role for competitive advantage. [11]

The recent issue is how information technology (IT) can help firms to create competitive differentiation; recent studies [11] have shown that it is obviously important and challenging to implement a sophisticated infrastructure IT, but managing it is the real source to reach a competitive advantage. It means that the main capabilities for this purpose includes IT management capabilities, which are IT business experience (extent to which IT groups understand business) and the relationship infrastructure (extent to which there are positive relationship between IT and business managers).

These capabilities require long time to be internalized and evolve through “learning by doing”, so they are difficult to imitate and represent the main source for a long-term advantage in the market.

As concerns this work, the purpose is to take into account two principal aspects of technology, in particular tangible asset and resources, like software and machinery used within the factory.

2.3.1. Software

The adoption of software in factories seems to be a good way to optimize processes by reducing time and costs of some operations. The implementation of software requires an initial investment that could be considerable in terms of costs, for example to buy the software and to pay learning courses for employees, but also because every change requires the modify of consolidated routines and so it takes time to be internalized within the organization.

ELKA factory uses CableBuilder [11], which is a software for designing cable that facilitates the offer of a personalized product by reducing the cost of quality. In fact it helps design engineers to create a product that meets the customer requires and to do it quickly, reducing the quotation cycle and the waste, and consequently the related time for managing scraps and for reworking. CableBuilder offers the possibility to generate automatically accurate costs, bill-of-materials, manufacturing datasheets and catalogue and it also can be integrated with ERP systems such as SAP.

Some of tools offered by CableBuilder are:

- Support for national and international standards
- Support for every cable construction or type
- Datasheet generation in many formats, such as PDF or Microsoft Excel
- Generation of product catalogues
- Generation of manufacturing instructions
- Side-by-side design comparison between a number of designs or versions of the same design
- Online customizable costing with unlimited cost types.

The resulting images can be shown to the user in 3D (Figure 18.) or 2D (Figure 19.), with color or black and white, and saved in either JPEG or SVG file format. Therefore, it is possible to

obtain an interactive 3D model and to use the mouse to visualize it from different points of view.

[12]

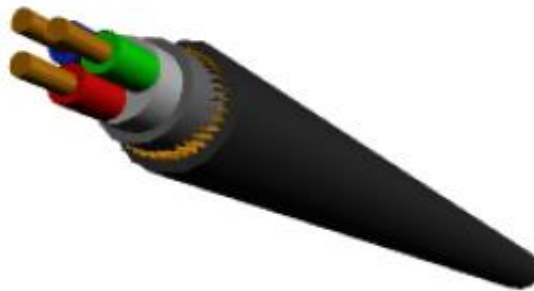


Figure 18. Interactive 3D model by CableBuilder software

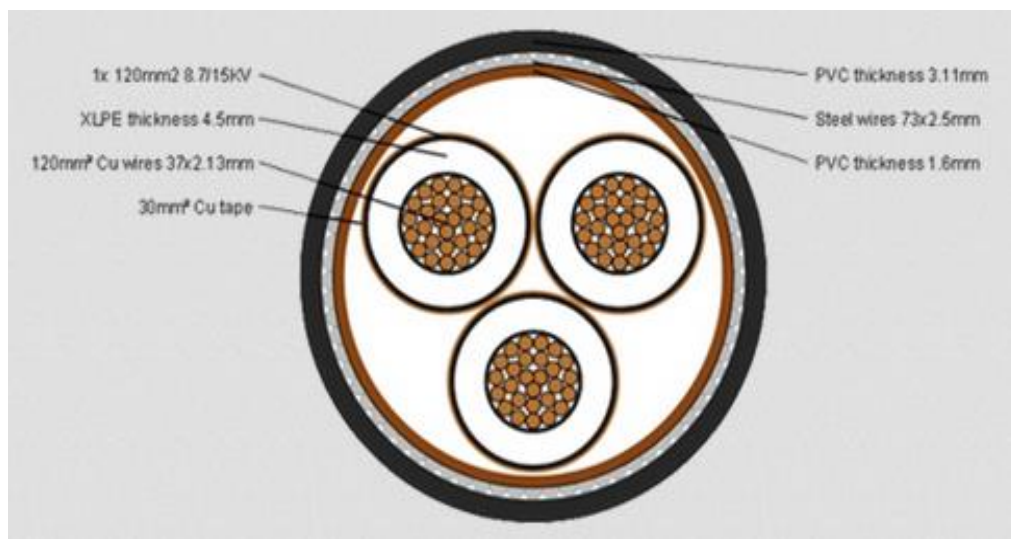


Figure 19. Medium Voltage Cable in 2D by CableBuilder software

The importance of giving manufacturing process specifications, such as correct machine, setup and processing times is crucial to calculate the product costs and also to scheduling manufacturing and raw material ordering. Moreover, CableBuilder offers integrated datasheets and reporting, that can be continuously updated, giving to the factory the flexibility to introduce changes and to answer promptly to the customer requests.

It is possible to utilize different formats for datasheet, including RTF, PDF, Microsoft Excel, depending on the particular purpose. The following image (Figure 20.) shows an example of a datasheet generated from live instances of CableBuilder.

1 / 1 84.3% Find

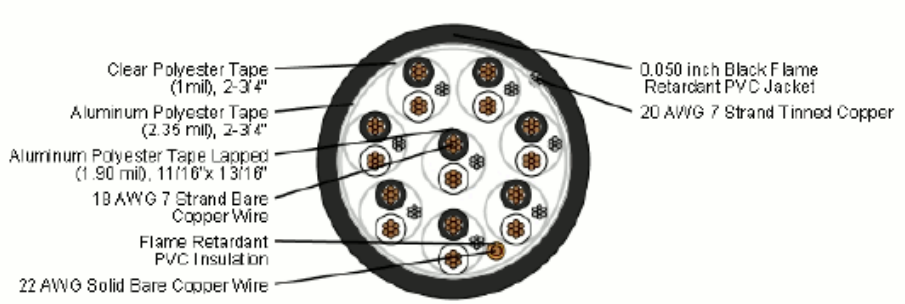
Dekoron®
Wire & Cable, Inc. *The Instrumentation Cable Experts*

1300 Industrial Blvd.
Mount Pleasant Texas USA 75455
Tel: 903-572-0657
Fax: 903-572-6153
Web: <http://www.dekoroncable.com>

Dekoron Cable Product Specification

Instrumentation Cable

Part Number : 1874-80880



Clear Polyester Tape (1 mil), 2-3/4"
Aluminum Polyester Tape (2.35 mil), 2-3/4"
Aluminum Polyester Tape Lapped (1.90 mil), 11/16" x 13/16"
18 AWG 7 Strand Bare Copper Wire
Flame Retardant PVC Insulation
22 AWG Solid Bare Copper Wire

0.050 inch Black Flame Retardant PVC Jacket
20 AWG 7 Strand Tinned Copper

Voltage Rating : 300V UL PLTC/ITC
Construction : Multiple Twisted Pairs each Pair Shielded and Overall Shielded
Number of Pairs : 8

Cable Components		Finished Product Attributes
Conductor :	18 AWG 7 Strand Bare Copper	Min Bend Radius : 3.89 in
Insulation :	15 Mil FR-PVC	Cable Weight : 233 lb/Mft
Color Code :	White/Black-White Numbered	Copper Weight : 119 lb/Mft
Individual Drain :	20 AWG 7 Strand Tinned Copper	Dia. Overall Nom : 0.590 in
Individual Shield :	Aluminum/Polyester Tape	Dia. Overall Max : 0.648 in
Comm. Wire :	22 AWG Solid Bare Copper, 9 Mil FR-PVC Orange	
Binder Tape :	Clear Polyester	
Overall Shield :	Aluminum/Polyester Tape	
Overall Drain :	20 AWG 7 Strand Tinned Copper	
Ripcord :	Ripcord	
Jacket :	0.050 In. Flame Retardant PVC Black Jacket	

Product Specification Sheet subject to change without notice

Figure 20. Example of a datasheet by CableBuilder software

The aim for cable industries is that to enhance their competitiveness in order to survive in a market that continuously pushes for the reduction of costs. For this purpose, CableBuilder can experiment different constructions of cable, with different use of materials, in order to optimize the design and to keep low the cost of materials that impacts for the 70 % of the cost price.

Moreover, this software offers the possibility of integration within the organization. In fact, the open and scalable architecture enables the company to share design information internally and externally, by choosing the format, such as PDF-format or XML-format.

[REDACTED]

[REDACTED]

[REDACTED]

[REDACTED]

[REDACTED]

[REDACTED]

[REDACTED]

ERP⁴ systems are computed-based systems designed to process organization's transactions and facilitate the integration and real-time planning, production and customer response. ERP systems are integrated software packages that cover all business functions in order to improve the efficiency of enterprise management, by modelling and automating many of the basic processes of a company from finance to the shop floor. It is possible to integrate information across the company by eliminating differences in format and to reduce the asymmetries between different functional groups by using a single display easily accessible to all. The implementation of ERP systems requires huge investments for hardware, software, professional services and internal staff costs. Moreover, the transition from traditional systems to ERP is a long process, as new skills have to be learnt and new procedures have to be followed; it is suitable to give proper training to the employees in order to get them used to the new system. If the management take care about the implementation, it will be possible to enjoy the various benefits and to simplify and automate repetitive tasks and procedures. [12]

In ELKA the ERP system used is SAP, which is one of the most popular and powerful ERP system created by SAP AG, a German company. SAP is composed by various modules, which can manage different processes inside the enterprise. SAP's modules are:

- BC Basic Components
- FI Financial Accounting
- W FI-CA
- AM Asset Management

⁴ Enterprise Resource Planning

- CO Controlling
- CS Customer Service
- MM Material Management
- WM Warehouse Management
- SD Sales and Distribution
- LE Logistic Execution
- PP Production Planning
- PS Project System
- PM Plant Maintenance
- QM Quality Management
- HR Human Resources.

SAP R/3 is the last generation coming after R/1 and R/2 and it is the client/server version of the software with an architecture in which the three layers Presentation, Application and Data Base are installed in three server/system (Figure 21.).

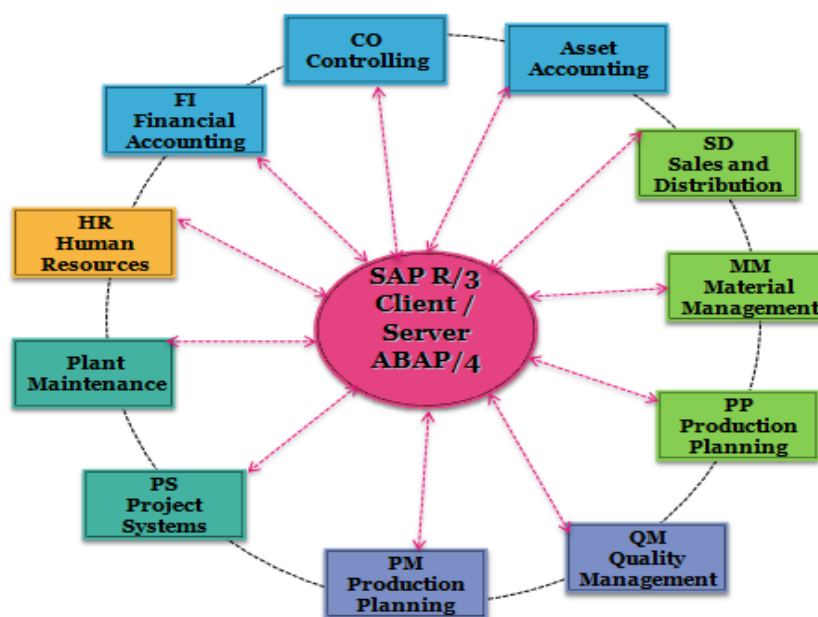


Figure 21. SAP R/3 modules and integration

SAP R/3 PP is a module used for Production Planning that is highly integrated with other modules like Material management, Financial Accounting, Cost Accounting, Human Resources

& Development, Sales and Distribution. The production planning is an activity performed before the production process, and involves the schedule of production, sequence of operations, economic batch quantities, and the dispatching priorities for sequencing of jobs. It is important to pay attention to this process, because the proper scheduling and expediting of work helps in providing better services to customers in terms of better quality of goods and respect of delivery dates. Moreover, it guarantees a better control of inventory, a proper utilization of equipment and other resources, a reduction of the idle time.

SAP PP is mainly divided in two parts: planning and execution. Planning regards especially the material planning and the capacity planning, while execution contains creation of production order, scheduling, work centers, confirmations and goods movements. [4]

[REDACTED]

The main goal was that of keeping production costs down by improving the processes efficiency, without compromising the quality. Therefore, the creation of standardized business and production practices is crucial to achieve better results, and the integration between the system IT and SAP guarantees the right support to basic processes and requirements of the cable industry.

[REDACTED]

[REDACTED]

With the X-ray technology, it is possible to obtain all information during the production, and to individuate immediately defective products in order to keep costs low by reducing the amount of scraps. Therefore, a permanent online quality control is necessary to survive in a competitive business as it guarantees a better process control, the increase of the productivity and the possibility of saving costs. In a wire and cable industry, the quality is essential because a quality issue is also a safety issue: a cable needs to comply with an increasing number of requirements to protect consumers and their property against a range of issues, such as electric shock and fire propagation.

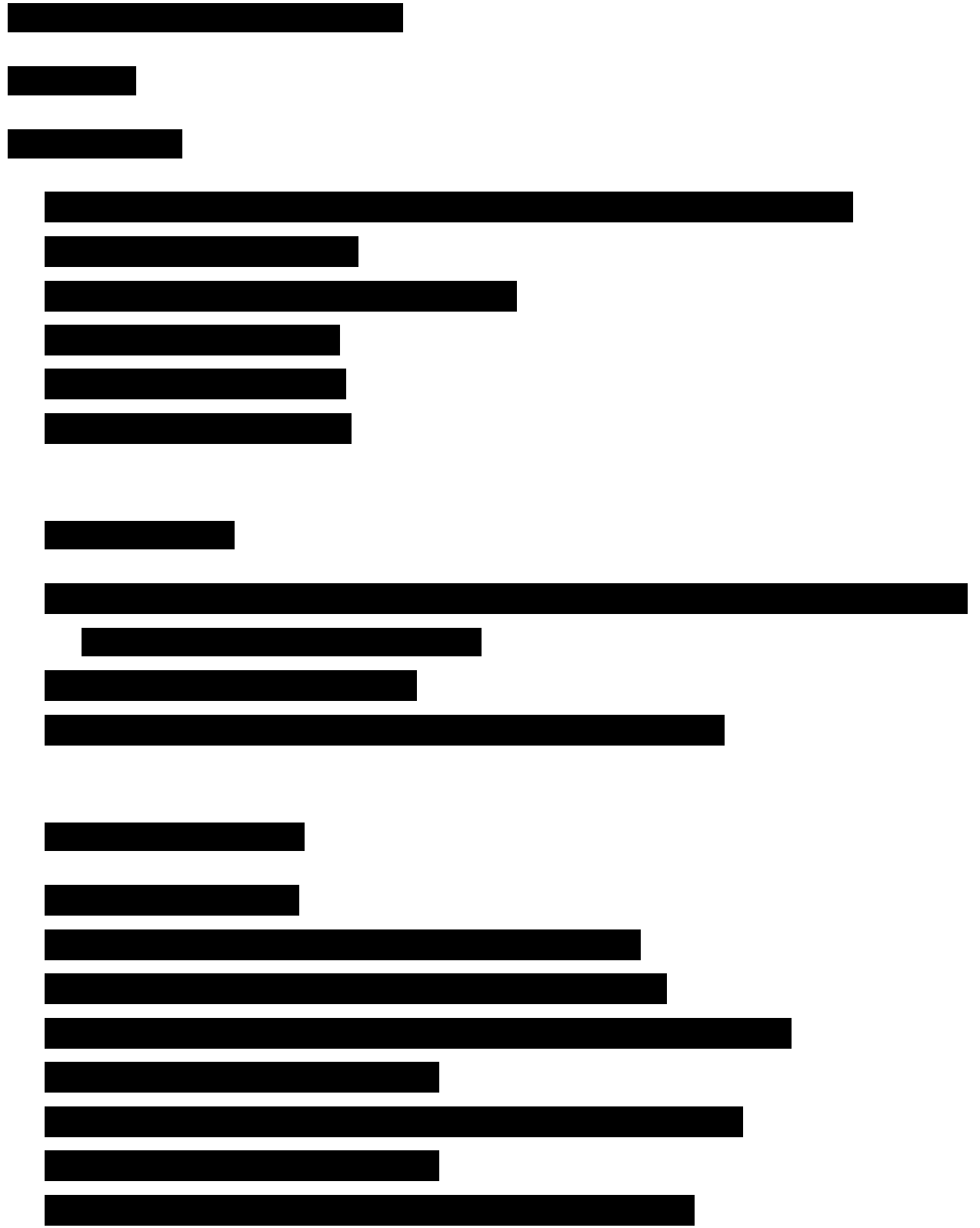
[REDACTED]



Figure 22. Display and control device ECOCONTROL 6000

2.3.2. Machinery

The total amount of machinery of ELKA is very large, but it is useful to take into account those that are more used within the factory to accomplish the manufacturing process



2.4. Buildings, installations and plant layout

ELKA central factory is located in Zagreb and together with the Metal Ropes plant in Zadar covers an area of 188 000 m². The main factory is composed by several building; at the entrance it is possible to find the administration, Research and Development laboratories, management offices (Figure 23.). Moreover, there are a warehouse for raw materials, warehouses for finished products, one for flammable liquids, one for gas bottles. Production materials are granules, raw materials for rubber, rubber mixtures, conductor materials (Cu, Al, optical fibers), hydrogen, tapes (paper, plastic metal), paint diluent and varnishes, wire for reinforcement and metal wire (steel, aluminum), elements for termination, or packaging. Production materials are submitted to an input test to check if they have the prescribed quality, and then accepted materials are indicated with the letter "O". The materials in the warehouse must be neatly arranged and are available with a visible name (label) and a material status label; each packaging unit (sacks, reel, barrel, crate, bundle, box) must have a label indicating materials, producers, series, batch numbers or work order. The unused materials from the production return to the warehouse accompanied by the document Return Material, which indicates the date of the return; if during the production a material does not meet the required quality, it is token back to the warehouse to activate material recovery procedures.

There are also some areas outside (Figure 24.):

- Area for finished products
- Area for semi-finished products
- Area for empty spools
- Space for transports.

Both internal and external storage space must guarantee the optimal accommodation of materials, preservation of the damage, safety, transparency and orderliness.



Figure 23. ELKA factory and buildings



Figure 24. Outside storage area

Facility layout is the physical location of the various department/units, workgroups within the departments, workstations, machinery and stock-holding points within a production facility. [16] Layout decisions have the objective to create a smooth workflow, in order to reduce material handling costs, movement of people and material and to increase the production capacity, labor efficiency and space utilization. Therefore, the scopes of layout can be divided in two groups:

- Related to material: less material handling and minimum transportation costs, less waiting time for in-process inventory.
- Related to work place: safe working conditions, minimum movement of workers, least chances of accidents, proper space for machine, tools and worker.

[REDACTED]

[REDACTED] technology layout, machines are grouped together into cells. Each cell contains machine that have to work a single part family, obtained by grouping parts with similar characteristics. The main advantage is the possibility to reduce handling material costs and in-process inventory, but also that of simplifying machine changeovers. [16]

In ELKA factory, the production facility layout is divided in four main departments:

- Metal department
- Rubber department
- Thermoplastic and Elastomer department
- Painting department.

[REDACTED]

2.5. Processes and departments

ELKA is organized in a functional structure, composed by different departments with a head department that refers directly to the company director and he is responsible for the performance of his unit. It is a kind of structure oriented to efficiency and productivity because people are grouped as per their area of specialization. Moreover, the organization control is easier but it is important to improve the horizontal and vertical communication. In fact, often in most organizations with functional structure the units can be too much separated with an inadequate information flow between them. Therefore, the integration is essential for taking the maximum advantage from this kind of structure.

In ELKA, the main departments are Production, Research and Development, Finance, Commercial (Figure 25.).

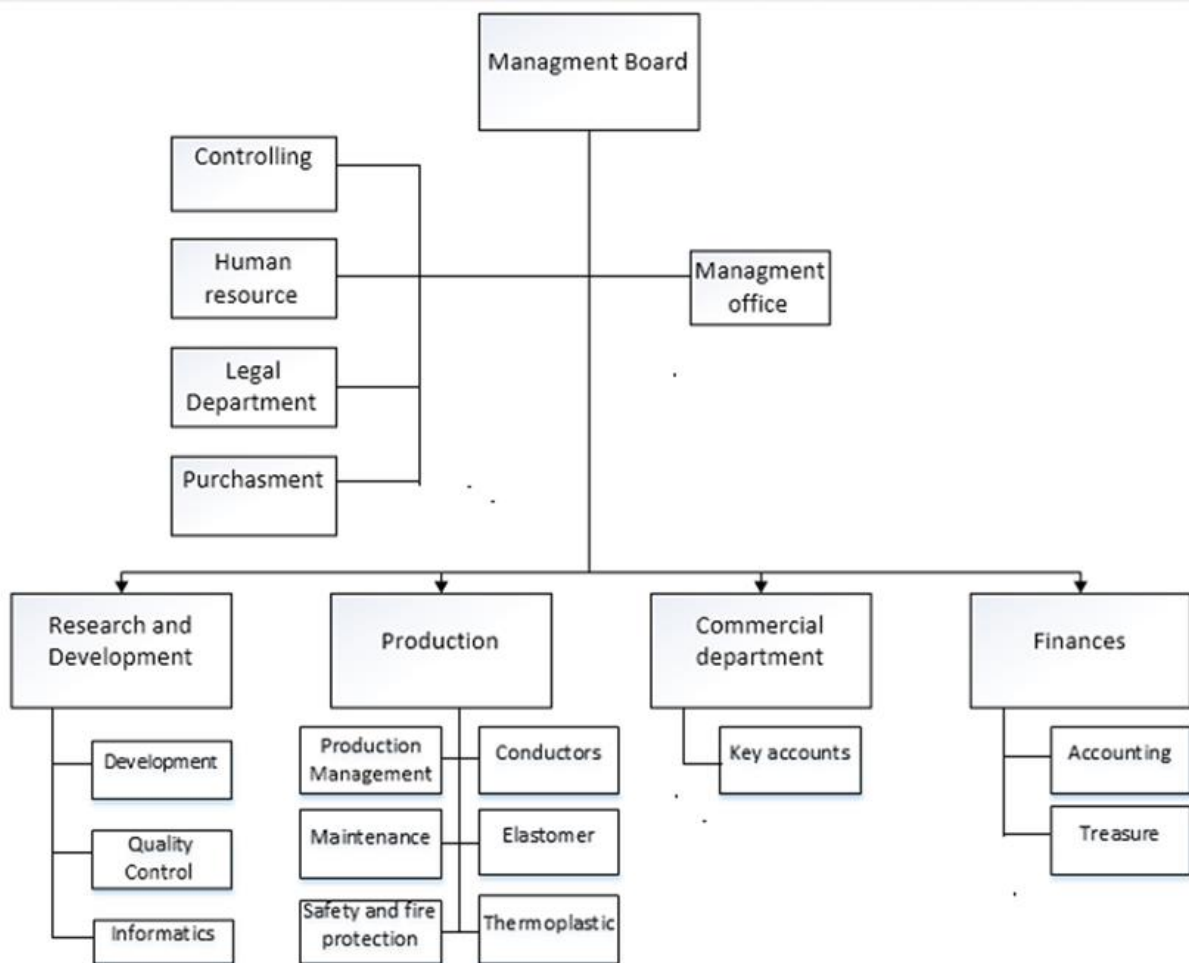


Figure 25: Organizational chart

[Redacted text block]

[Redacted text block]

[Redacted text block]

[Redacted text block]

[Redacted text block]

[REDACTED]

Another important aspect regards the environment policy: the company strives, by all criteria, to perform as little impact as possible on the environment. It includes the surveillance of certain aspects of processes, the implementation of specific programs and the choice of environmentally acceptable materials or technologies.

2.6. Cable manufacturing process

[REDACTED]

[Redacted text block]



[Redacted text block]

[Redacted text block]



[Redacted text line]

[Redacted text line]

[Redacted text line]

[Redacted text line]

[Redacted text line]

[Redacted text line]

[Redacted text line]

[Redacted text line]

[Redacted text line]

[Redacted text line]

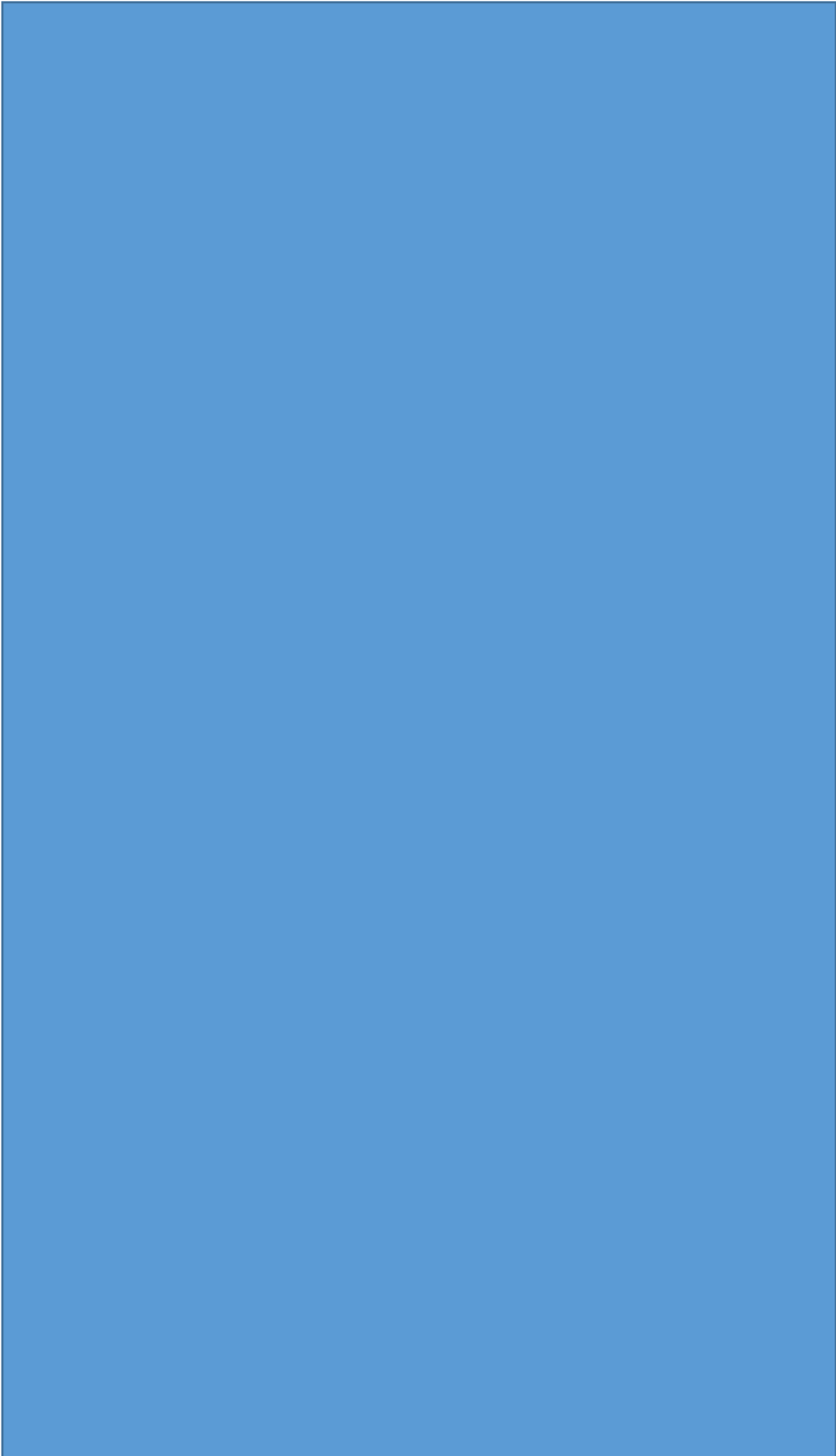
[Redacted text line]

[Redacted text line]

3. IDEAS ON POSSIBLE IMPROVEMENTS

[REDACTED]

⁵ Make To Order



[Redacted text block]

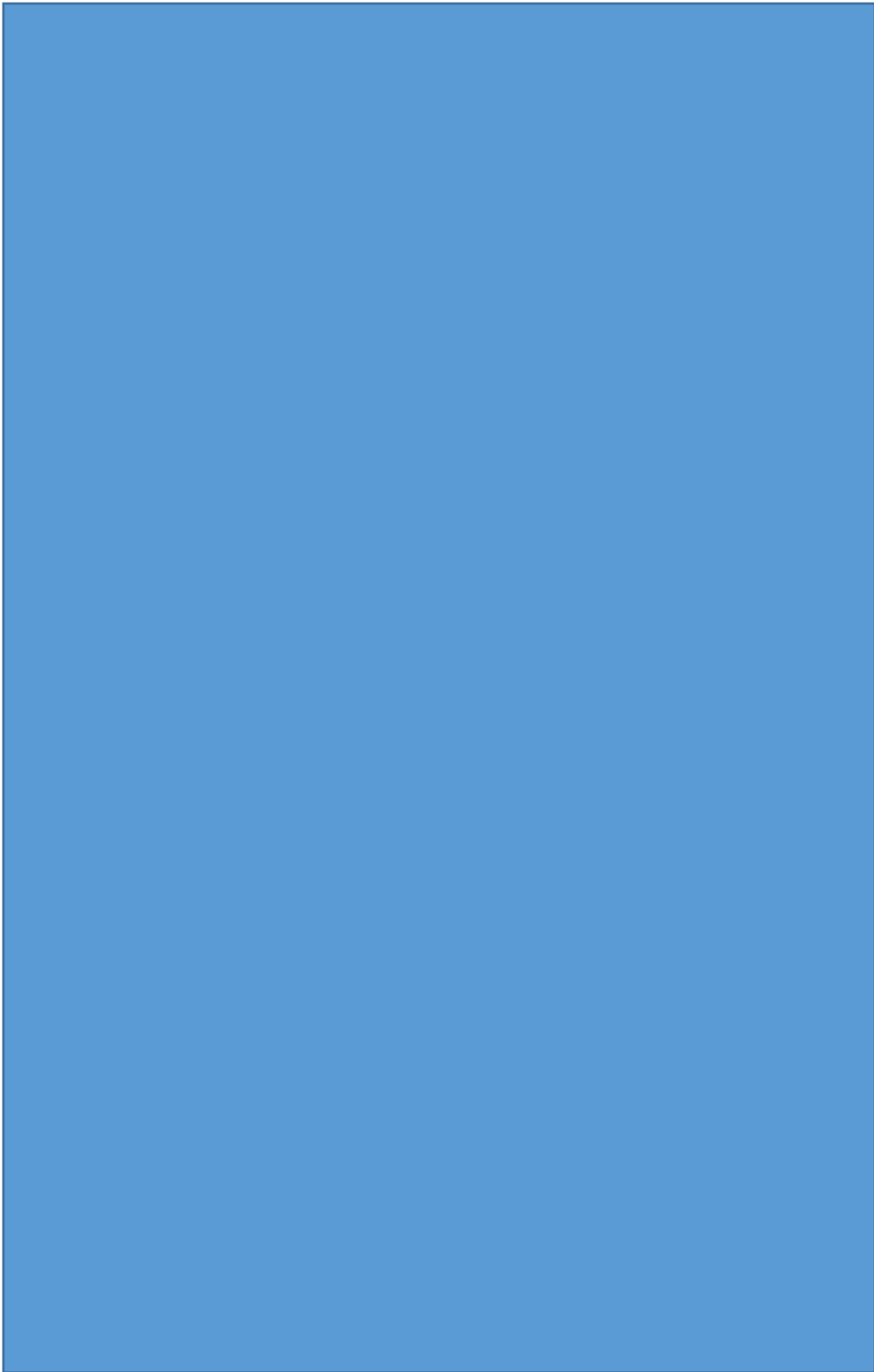


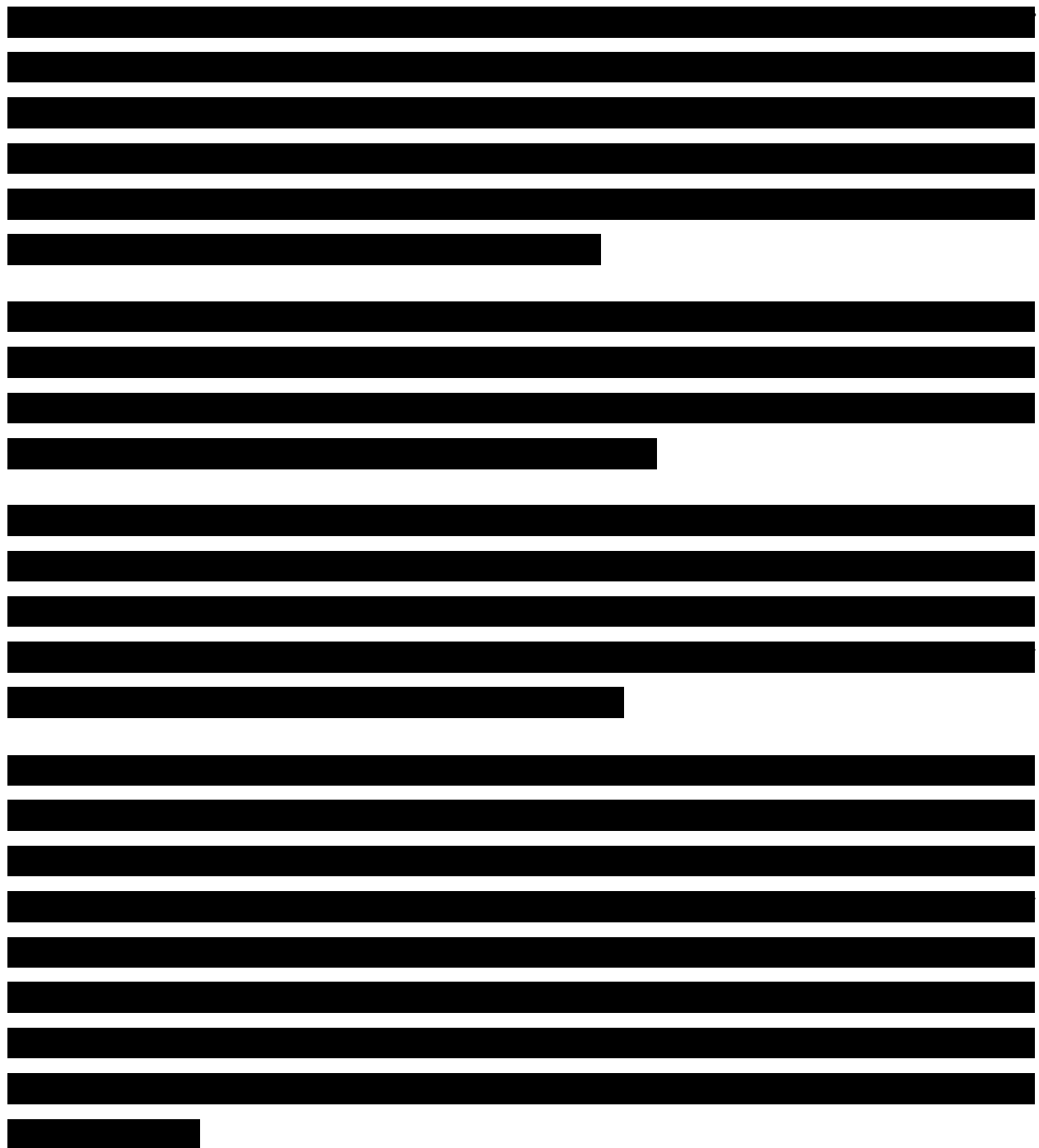
Figure 29.

[Redacted text block]

[Redacted text block]

[Redacted text block]

[Redacted text block]



Moreover, RFID offer the possibility of integration with ERP systems in order to take the maximum advantage by using this technology (Figure 30.). In fact, it provides information on the availability of materials, machinery and components and on the inventory levels, by eliminating paperwork and reducing downtime. The major benefits can be summarized in:

- Improvement of quality control
- Improvement of asset utilization
- Improvement of inventory tracking and visibility
- Reduction of scarp and increase of line performance.

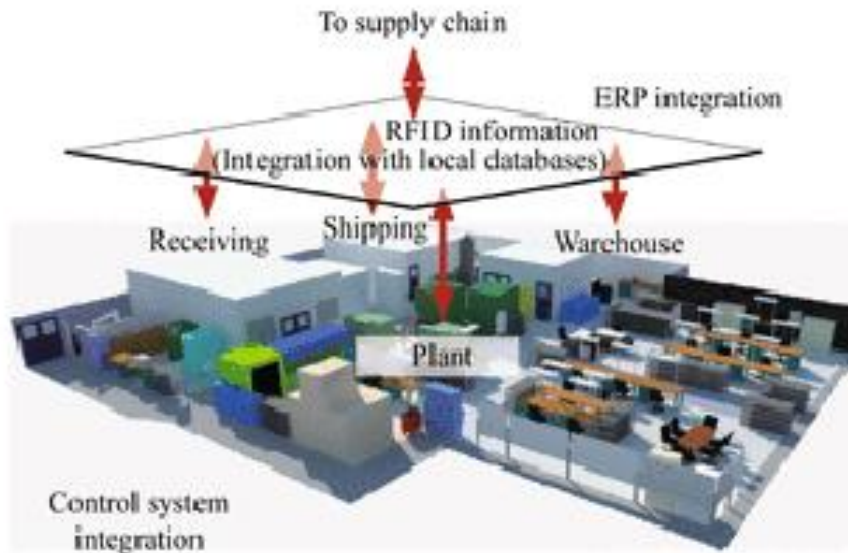


Figure 30. RFID and ERP integration

[REDACTED]

In a traditional approach, the R&D department determines the required feedstocks for the product, procurement determines supply availability and negotiates with suppliers for acquiring materials; manufacturing determines the production process and requirement, and marketing and sales department provide demand signals and sets the price for the finished product. If purchasing renegotiates a higher price for raw material to ensure availability when prices are rising, but sales has already locked the company into a non-negotiable contract, the company must assume the full cost of mitigating the supply risk. So, in this case when the price of raw materials rise highly, the company's financial can collapse and there will be huge losses. [20]

⁶ Work In Process

Another wrong way to manage the volatility is that to replenish the warehouse as much as possible when the prices of raw materials decrease. At first could seem to be the right way to save costs, but in the long-term, the storage costs and the risk of obsolescence are significantly high.

It could be useful to refer to the **Kraljic matrix**, which shows the different strategies that can be implemented according to the different types of materials (Figure 31.). The keys are the profit impact, that is the volume or value purchased, and the supply risk/criticality that refers to product availability, number of suppliers, ease of switching a supplier, and availability of substitutes.

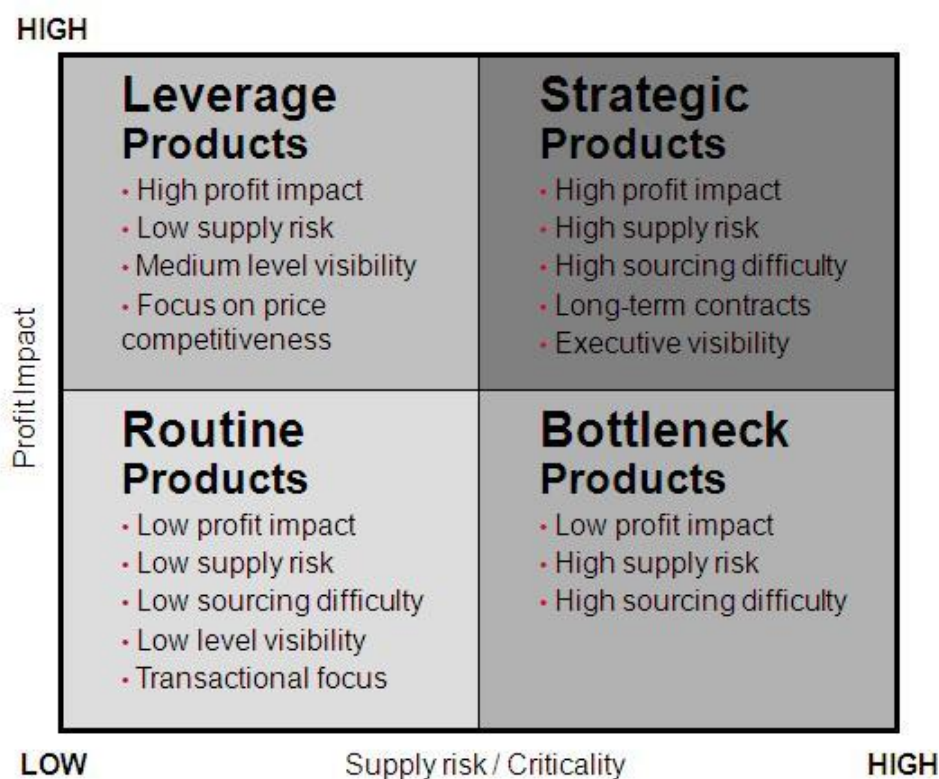


Figure 31. Kraljic matrix

The purchase of copper and aluminum materials is in the category of Strategic Products, with high profit impact and high supply risk. For this kind of purchase, it is suitable to implement a partnership with few suppliers based on long-term contracts and risk sharing. The solution for managing the risk could be a long-term fixed contract, in which the price is fixed and when the market price of the raw material is higher than that in the contract, the two parts share the risk and the losses.

The idea is to enhance the risk management within the organization, this requires a strong coordination across the business units but also the use of adequate tools to monitor and identify possible risks. It could be useful to create a temporary inter-functional team to manage changes

in the price of raw materials. The dedicated team could help the organization to defend against price increases and try to reduce the costs by taking corrective measures and finding adequate solutions.

The team needs to have different skills:

- Financial skills about prices, options, and fixed-price agreements
- Operational skills regarding technical features of raw material, design changes and inventory management
- Analytical and negotiations skills.

After the creation of a partnership, it is possible to introduce a **Kanban** system to handle the raw materials warehouse. (Figure 32.). The Kanban system is composed by cards, which represent a signal for replenishment and provide information about the quantity and the location of the materials. It is a visual control that can reduce the space requirements, material handling and inventory shortage or excess. In fact, when a particular material moves to the production, the relative Kanban is taken by the operator and put in the Kanban card post. The supplier takes the cards from it and delivers just the necessary items to replenish the empty bin. In this way, there is a total control of the process and the reduction of storage costs.


	From	To	
Supplier	Vision Cell		
Shipping Post	Receiving Post		
L 5	M 4		
Part No. 760001B245515F Polyurethane. 90D			
		Storage Location M-4-B	
Container Type Gaylord	Number of Kanbans	2/3	
Container Capacity	1000		

Figure 32. Kanban card

The Kanban card contains all the needed information: name of the material, quantity, storage location and go on. It is possible to use it also for plastic replenishment, attaching a Kanban card on the plastic box. When the plastic pellets are consumed, the relative card is taken and put in the cardboard; each day the material planner collects the Kanban cards, checks the requirements and sends a fax to the supplier. The result is an organized warehouse, with a better space utilization and the possibility to obtain the material when it is required.

After the implementation of changes, it is also necessary to monitor the results using a **performance management system**. Some indicators could be the customer satisfaction, the productivity, the on-time delivery or the lead-time. It is possible to choose them in order to focus on the main aspects of the processes. Changes within the organization are often difficult to implement, so it is useful to collect information about improvements in performance and good results, and communicate them to all the people involved in the process.

Another tool for improvement is the use of **simulation** within the factory in order to investigate potential problems and to introduce optimization, by evaluating the outputs of the systems according to different scenarios. Simulation is a sophisticated tool that can help factories to analyze their production systems saving time and money and without disturbing the real system, because the experiments are made in a built model. The introduction of simulation within a factory represents an important challenge to reach continuous improvement and to observe the effects of future decisions on the actual system.

The analysis of production process by simulation will be considered in detail in the second part of the work.

4. SIMULATION – A GENERAL VIEW

Simulation is the discipline of designing model of an actual or theoretical physical system, executing the model on a digital computer and analyzing the execution output. A system is defined as a collection of interacting components that receives input and provides output for some purpose. Modeling is the study of the mechanism inside a system by inferring a model, which is only the representation of the reality and should never be confused with it. In fact, a model is a reflection of the modeler's understanding of the reality, of its components and their interrelations. [21] The computerized model is an operational computer program that implements a system model; from computer runs, it is possible to obtain a record of predicted behavior of the system. Measurements, on the other hand, make it possible to obtain a record (table or graph) of physical system behavior. The level of agreement between the observed and the predicted behavior is the essence of model validation and it is obtained by comparing simulation results with measured or observed data (Figure 33.). The evolution of a valid model is an iterative process that consists in modifying it to reduce the differences between model and system behaviors. [21]

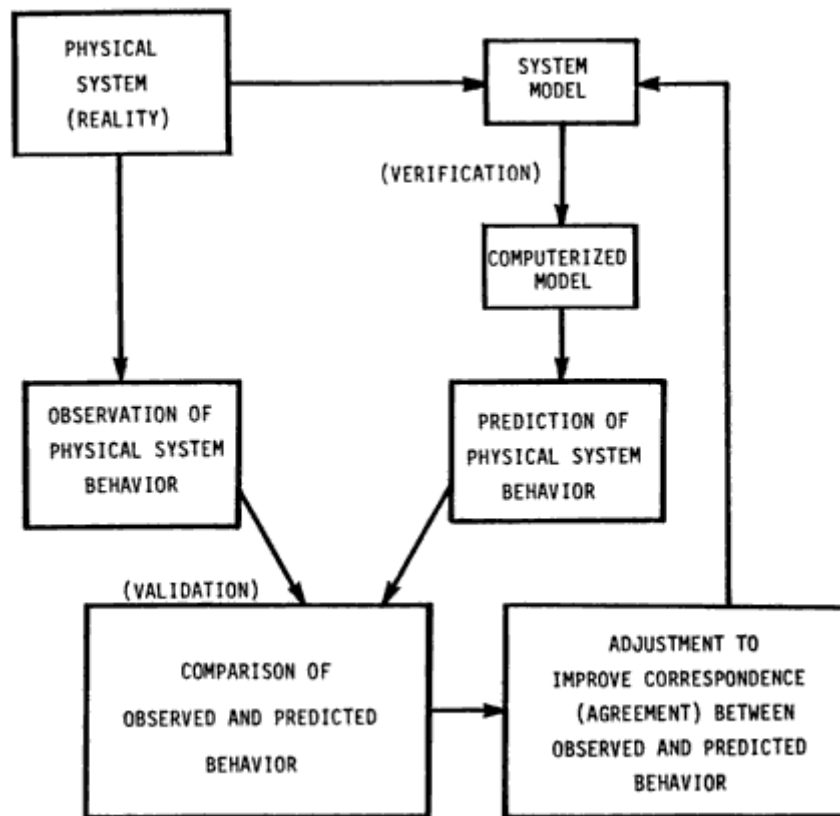


Figure 33. Building a credible model

The main purposes of simulation includes:

- Gaining insight into the operation of a system: the study of components and their interactions within a complex system to individuate problems. An example for a manufacturing process is to understand how bottlenecks occur.
- Developing operating and resources policies: the aim is to improve system performance, for example by changing scheduling priorities for work orders.
- Testing new concepts and/or systems before implementation: if a system does not exist, simulation model can help to give an idea how well the proposed system will perform. It is possible to evaluate different levels and expenses of equipment and the configuration of the chosen equipment.
- Gaining information without disturbing the actual system: simulation makes possible to analyze the system and to make experimentation without compromising its normal activity. It is particular useful for critical or sensitive systems that cannot be disturbed or stopped. [22]

The main advantages of using simulation include the possibility of conducting experimentation in a compressed time, the reduction of analytical requirements and the animation for

demonstrating how model works. In fact, because of the model is simulated in a computer, the simulation runs of lengthy processes can be compressed in seconds. This also can increase the statistical reliability of the analysis because it is easier to conduct multiple replications. Moreover, the existence of computer simulation has reduced the use of more analytically demand tools, which were domain of mathematicians and operations research analysts. In fact, the development of simulation software packages have provided more practitioners, with different variety of knowledge, with the opportunity of analyzing many more types of systems. Furthermore, many simulation software packages possess the capability of dynamically animating the model operation. Animation is both useful for debugging the model and for easily demonstrating how the model works and handles different situations. [21]

Although the use of simulation has many advantages, it is important to take into account that the quality of the model and the results depends on the accuracy of the input data. Moreover, simulation does not solve problems by itself, but it provides responsible managers with potential solutions that need to be correctly implemented. Simulation can be also very time consuming and hence costly, in fact a complex system requires a large amount of time for data collection, modeling building and analysis (Table 4.). [22]

Table 4. Advantages and disadvantages of simulation

Advantages:	Disadvantages
<ul style="list-style-type: none"> • Choose correctly • Compress and expand time • Understand why • Explore possibilities • Diagnose problems • Identify constrains • Develop understanding • Visualize the plan • Build consensus • Prepare for change • Invest wisely • Train the team • Specify requirements 	<ul style="list-style-type: none"> • Model building requires special training • Simulation results may be difficult to interpret • Simulation modeling and analysis can be time consuming and expensive • Simulation may use inappropriately

The main components of a basic model are entities, queues and resources (Figure 34.). An entity is something that changes the state of the system; it can be a person, for example a customer in a customer service center, or an object, for example a component waiting to be machined. The number of entities that arrive in the system is known as the batch size, and it can be constant or different. The amount of time between batch arrivals is known as the inter-arrival time and it consists in the interval from which the last batch arrived to when the current batch arrives. Entity may also possess attributes, which are variables with values unique to each entity in the system.

The second mayor type of components are queues, in fact entities generally wait in a line until it is their turn to be processed; simple systems usually use first-in-first-out (FIFO) queue priorities. The third component is resources, which process or serve entities that are in the queue. Example of resources are customer service representatives, factory machines, loan officers. In simple models resources can be either idle or busy. When a resource is idle, it is available for processing, while if it is busy it means that it is processing entities. In more complex models resources can be also temporarily inactive or failed. Inactive resources are unavailable because of vacation, preventive maintenance period, or scheduled work breaks, while failed resources depend on broken machines or inoperative equipment. Resources take a certain amount of processing time to serve the entities, which is normally known as an input data for the simulation process. [25]

The simulation event list keeps track of different things that occur during a simulation run and can affect the state of the system. Typical events are entity arrivals to the queue, the beginning of service times for entities, and the ending of service times. These events can increase or decrease the number of entities in the system or queue and change the state of resource between busy and idle. [25]

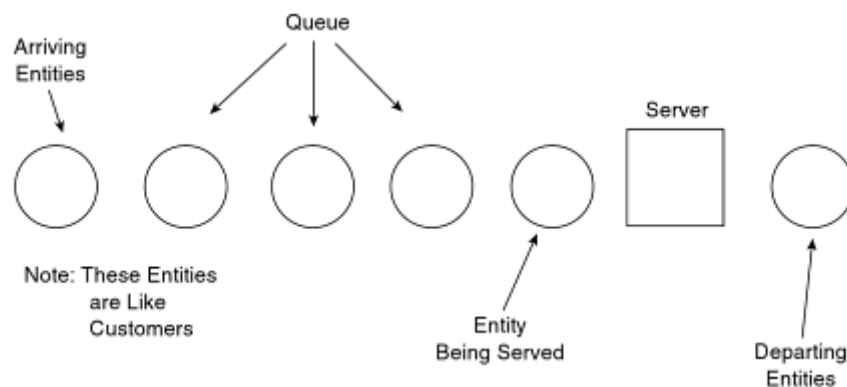


Figure 34. Basic simulation model components

In order to evaluate how well the system model performs, it is important to calculate some output measures, such as: [22]

- System time: the total amount of time that the entity spends in the system
- Queue time: the total amount of time that the entity spends in the queue
- Time-average number in the queue: the average expected number of entities in the queue at any given time during the period of interest
- Utilization of resources: it is obtained by summing the length of time that the resource is either busy or idle and then dividing by the total time of the simulation run.

A typical approach for simulation consists of different steps (Figure 35.):

1. Formulation of problem: definition of requirements of simulation main goals
2. Test of the simulation-worthiness: examination of some aspects like system limits, complexity or inaccurate data
3. Formulation of targets: definition of target system (top target and sub-targets) such as minimization of processing time and inventory, maximization of resource utilization or increase of in-time delivery
4. Data collection and data analysis: definition of required data for simulation, such as system load data, organizational data and technical data
5. Modeling: building and testing the simulation model
6. Execute simulation runs: realization of the experiments
7. Result simulation analysis and result interpretation: the correct interpretation of the simulation study output and analysis of causes for unexpected results
8. Documentation: a project report that should be a presentation of simulation results based on the customer requirement specification and it is also important to include proposal for actions. [22]

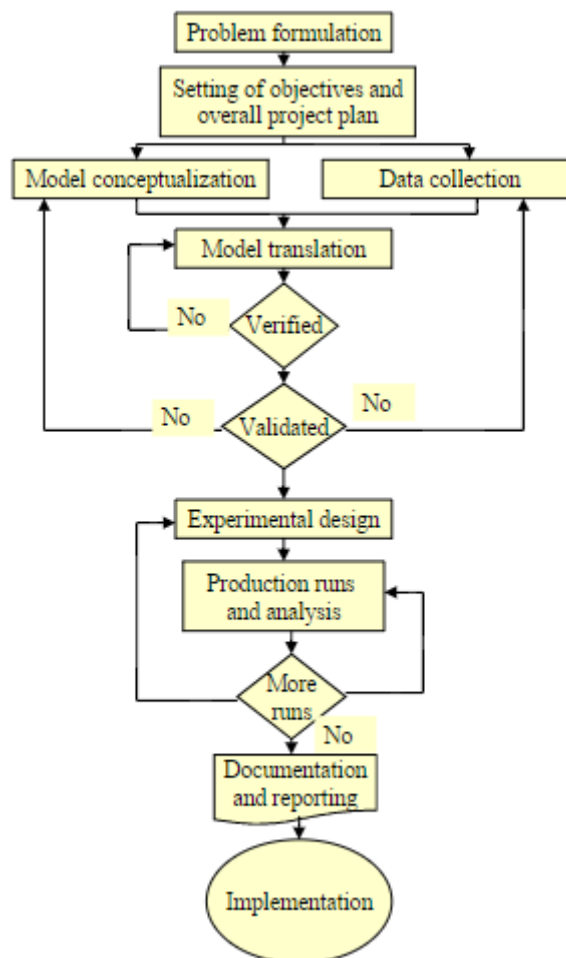


Figure 35. Simulation project

Many types of systems can be simulated, such as manufacturing, service or transportation systems. Moreover, the use of simulation takes place in different phases, such as planning, implementation and operation of equipment. Possible applications can be:

- **Planning phase**

- Identification of bottleneck in derivation of possible improvements

- Uncover hidden, unused potential

- Minimum and maximum of utilization

- Juxtaposition of different planning alternatives

- Visualization of planning alternatives for decision-making

- **Implementation phase**

- Performance tests

- Problem analysis

- Simulation of exceptional system conditions and accidents

- **Operational phase**

- Testing of control alternatives

- Proof of quality assurance and fault management

- Dispatching of orders and determination of the probable delivery dates. [26]

In the current global manufacturing scenario several trends have spread, such as increased product variety, product complexity, flexibility, shorter product cycles, shrinking lot sizes, competitive pressure demands for shorter planning cycles. [27] Simulation is an excellent tool where simpler methods no longer provide useful results and where the assembly and logistics processes are characterized by high complexity. Therefore, the use of simulation in manufacturing has become more and more important especially in the current scenario that requires punctuality and lower throughput time for competitive make-to-order factories, while for new products either faster manufacturing system design and reduced time-to-market. This means that the production systems have to be flexible and able to react to changing production capacity requirements. For this purpose, simulation offers the possibility to cut the time-to-market by supporting a concurrent development of the main processes from the conceptual design of a product to its introduction into the market (Figure 36.). It becomes possible to adjust work queues and orders, and to achieve a balanced rate of resource utilization. Simulation is also useful to increase the customer order delivery accuracy in make-to-order manufacturing: delivery days can be confirmed on the basis of the simulation model and overload situations can be eliminated. [22]

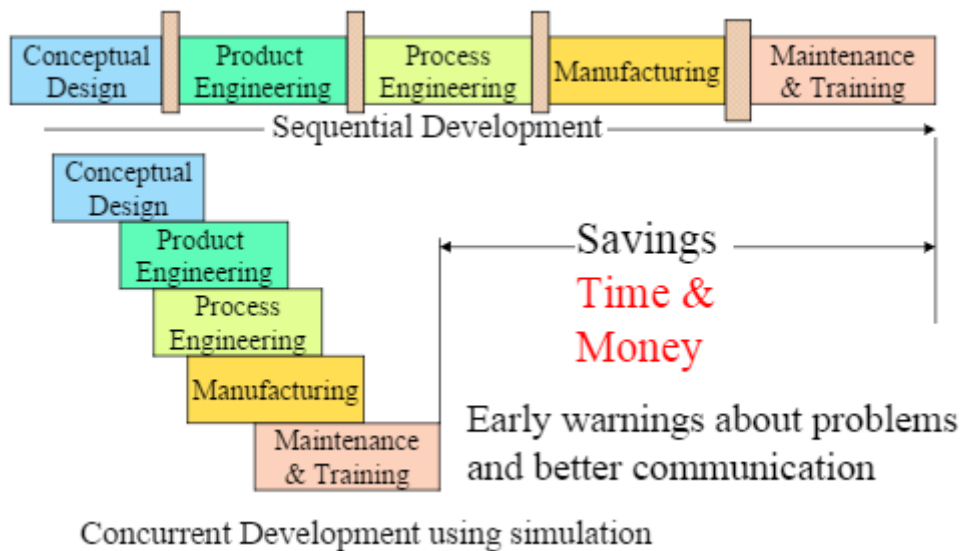


Figure 36. Reduction of time-to-market by using simulation

Manufacturing and material handling systems can be complex to model because of the high number of possible combinations of input variable that can be changed when trying to perform experimentation (Figure 37.). Some of the needed information are the physical layout, the product schedule (process and material flow, bill of materials), the production plan and control (assignment of job to work areas, task selection), the type of work-centers (processing, assembly, disassembly), the equipment (capacity, MTBF⁷, MTTR⁸), the storage (suppliers, spare parts, WIP). [22]

⁷ Mean Time Between Failure : predicted elapsed time between inherent failures of a system during operation [34]

⁸ Mean Time To Repair : measure of maintainability, average time required to repair a failed component [34]

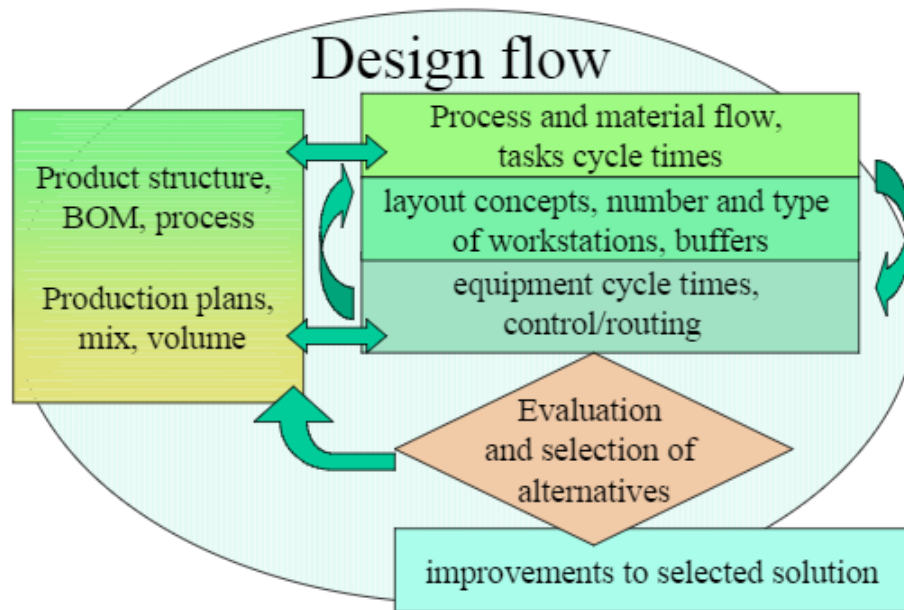


Figure 37. Building manufacturing system model

Manufacturing simulations are often used as measurement tools that predict the behavior and performance of systems that have not yet been implemented, or to determine theoretical capabilities of existing systems. Regarding the historical trends of the evolution of simulation, it is generally considered that the contemporary meaning of simulation originated by Monte Carlo method in 1777 (Figure 38.). It was an experiment consisting of repeatedly tossing a needle onto a ruled sheet of paper and observing the outcome with the aim to calculate the probability of the needle crossing one of the lines. During the following years, after the development of the manual simulation, it was created General Simulation Program in 1960, which is the first general purpose simulator for industrial plants. In 1963, the first version of SIMSCRIPT is presented for non-experts, while the combined simulation with user-interface known as SIMSCRIPT II.5 was developed in 1976. In 1978, computer imaging with the introduction of digital image generation represented an important contribution to the advance of simulation and in the beginning of the 1980s military flight simulators, naval and submarine simulators started to be produced. In 1990s, thanks to the increased computer power and commercial Virtual Reality (VR) applications, real-time simulations and interactive graphics become possible. In the years 1995-1998, high resolution graphics and new ranking and selection procedures were developed. [24]

Nowadays, the new generation of simulation software aim to facilitate the integration of the simulation system with the production planning and scheduling systems. Moreover, by combining the simulation system with the production database of the factory, it is possible to

instantly update the parameters into the model and to use it parallel to the real manufacturing process in order to support the decision-making.

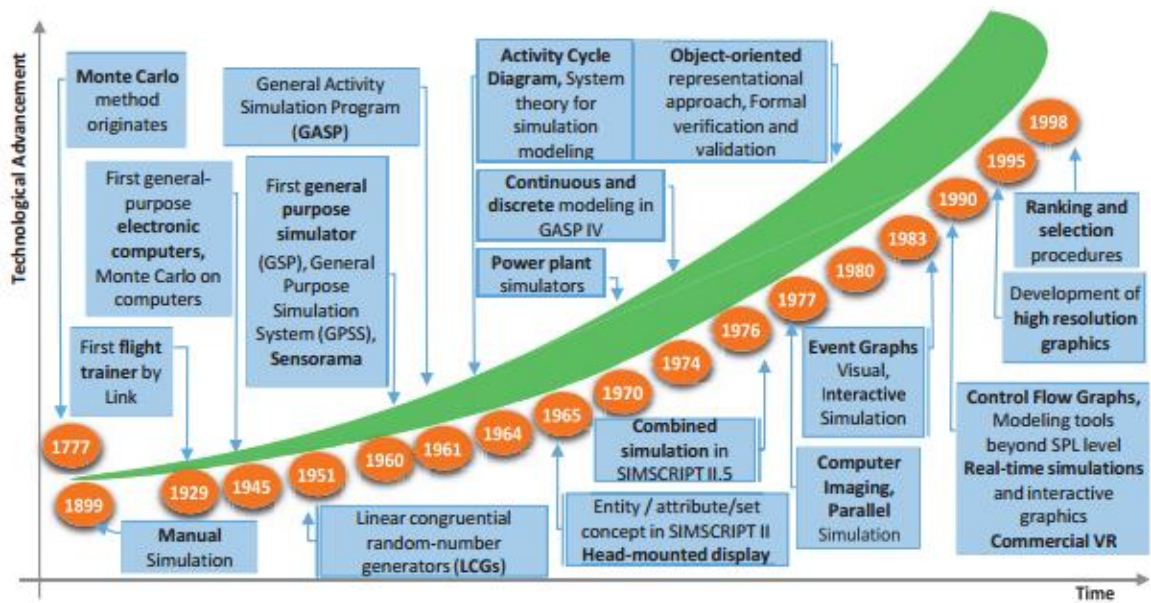


Figure 38. Historical evolution of simulation

According to the dependence of the time factor, simulation can be divided in static and dynamic: if static, it is independent of time, while dynamic simulation evolves over time. Dynamic simulation is further composed by continuous and discrete. In discrete simulation, changes occur at discrete points in time while in continuous, the variable of time is continuous. Moreover, it is possible to divide discrete simulation in time-stepped and event-driven. Time-stepped consists of regular time intervals and alterations take place after the passing of a specific amount of time; event-driven consists of irregular intervals and updates are linked to scheduled events. [24]

It is possible to individuate different product and production lifecycle tools: [24]

- Augmented reality (AR): it is a real-time view of a physical real world that has been enhanced by adding virtual computer-generated information to it. In general, the application of augmented reality consists an innovative and effective solution to simulate, assist and improve the manufacturing processes. The use of AR in manufacturing applications, such as CNC simulation and robot path planning, requires an high accuracy of position and orientation tracking. So, new challenges for the future consist in using systems, such as RFID and other types of sensing devices.
- Computer aided design (CAD): it is the use of computer systems to assist in the creation, modification, analysis and optimization of a product design. Current limitations are the

complexity of menu items and the inadequate human-computer interfaces, so it could be useful in the future to focus in usability and development of design routines.

- Computer Aided Manufacturing (CAM): it is the use of computer systems to plan, manage and control the operations of a manufacturing plant through either direct or indirect computer interface with the production resources of the plant. The future CAM systems need to focus on collaborative technics, effective communication and efficient data exchange among all the aspects of production, from humans to machines.
- Facility layout planning (FLP): it refers to the design of the allocation plans of the machines/equipment in a manufacturing shop-floor. The need to design and construct a new factory layout or reconfigure the current one has increased largely because of the fast changes in customer demand both from product quantity and product variety aspects. Using predefined objects, a layout model can be implemented in 3D and it is possible to export data in in XML or HTML format.
- Materials flow simulation: it refers to the movement of materials through a defined process or a value stream within a factory or an industrial unit for the purpose of producing a finished product. The adoption of production and materials flow control (PMFC) mechanism can be valuable for improving performance and quality of manufacturing service to customer, by responding quicker to market dynamics and varying demands.
- Process simulation: a manufacturing process is defined as the use of one or more physical mechanisms to transform the shape of a material and/or form and/or properties. The current emerging composite manufacturing processes have shown the need for process simulations to reduce time and cost associated with the product and process development, by modeling and dimensioning different parameters in a process chain.

Focusing on the areas of material flow simulation and layout design, the main tools are Anylogic by Anylogic, Arena by Rockwell, Automation FlexSim by FlexSim Software Products, Plant Simulation by Siemens, and Witness by Lanner. For the comparison between these different software different criteria groups can be considered, such as hardware and software aspects, general features (purpose of the software, experience required, ease of use), modeling assistance, simulation capabilities and input/output issues (Table 5.).

Table 5. Comparative matrix of commercial simulation tools

Criteria Groups	Comparison Criteria	Simulation Software Tools				
		AnyLogic	Arena	Flexsim	Plant Simulation	Witness
Hardware and Software	Coding aspects	****	***	**	****	**
	Software compatibility	***	**	***	****	***
	User support	****	**	****	****	***
General features	Purpose	General	General	General	General	General
	Experience required	***	****	**	***	**
	Ease of use	***	**	**	***	****
Modelling assistance	On-line help	****	**	****	***	**
	Library and templates	***	**	****	****	***
	Comprehensiveness of prompting	***	**	***	***	***
Simulation capabilities	Visual aspects	****	**	*****	****	***
	Efficiency	****	**	****	****	***
	Testability	****	***	****	****	***
Input / Output	Experimentation facilities	***	***	****	****	***
	Statistical data	****	***	****	****	****
	Input/output capabilities	****	**	****	*****	****
	Manufacturing capabilities	****	**	****	****	*****
	Analysis capabilities	***	***	****	****	***

The scale from 1 to 5 stars means:

* Inadequate, ** Adequate, *** Satisfactory, **** Very satisfactory, ***** Outstanding. [24]

Nowadays, simulation software tools usually offer only dedicated application object libraries for developing fast and efficient models of common scenarios which are limited in comparison to the broad field of manufacturing. Moreover, the majority of tools are focused only to a small percentage of all the functions or resources available. Another issue regards the integration, and the lack of proper data exchange among different domains and few common standards that cause difficulties in the interoperability and collaboration between system and partners. In fact, the integration of modelling tools with CAD, DBMS (Oracle, SQL Server, Access), XML save format, HTML reports is still limited and the goal is to develop simulation tools that will assure the multi-level integration among them. [27]

5. AIM OF SIMULATION MODELING IN ELKA

ELKA factory offers high-quality custom cables, and this leads to a product mix composed by high variety and low volume products. In order to compete in an uncertain market, the main goal is the differentiation from competitors and factors such as short lead times, high level of service, customer satisfaction have become more and more important during the last years. However, high variety may lead to some problems, such as the increase of manufacturing schedule complexity and the long lead times due to the higher number of changeover/setups needed when moving from high-volume standardize production.

The analysis of the production system has been developed [REDACTED] evaluating different production scenarios by the **Siemens (Tecnomatix) Plant Simulation software** (STPS). As said, ELKA factory offers high product variety and produces on a make-to-order basis; this creates problems in controlling part mix and batch sizes.

5.1. Production strategies

The main challenges are related to the reduction of the order lead times and to the increase of delivery reliability, which are factors necessary to enhance the level of service offered to the customer (Table 6.). Moreover, job-shop configuration of the layout may lead to high level of work-in-process and long manufacturing delays because of queueing delays at work centers. [28]

Table 6. KPI considered for the specific problem

KPI – Key Performance Indicators	Actions
Customer Satisfaction	Increase the numbers of order delivered to the customer on the delivery date
Lead Times	Optimize the material and information flows within the departments
Machine utilization	Optimize the distribution of the work load to the different machines

The use of simulation for this research regards the calculation of the resource utilization between different alternatives. It is also evaluated manually the number of forklifts necessary for increasing the efficiency of transports within the departments.

For Make-To-Order (MTO) products, the production starts when an order is accepted, so the probability of unexpected delays is higher than that of Make-To-Stock (MTS) products. For example, the delays are related to the possibility of machine breakdowns, schedule problems or defective products that need to be reworked. For this reason, the level of service in terms of shorter lead times is higher for MTS products that are based on demand forecasts. However, the adoption MTS strategy may lead to low flexibility and high level of stocks.

The study is focused on the metal department, which mainly contains wire drawing machines for copper and aluminum and stranding machines (Figure 39.). The wire drawing machines reduce the diameter of the core cable by pulling wires through a series of dies, because the raw material is too much thicker and the goal is to obtain more flexibility. [REDACTED]

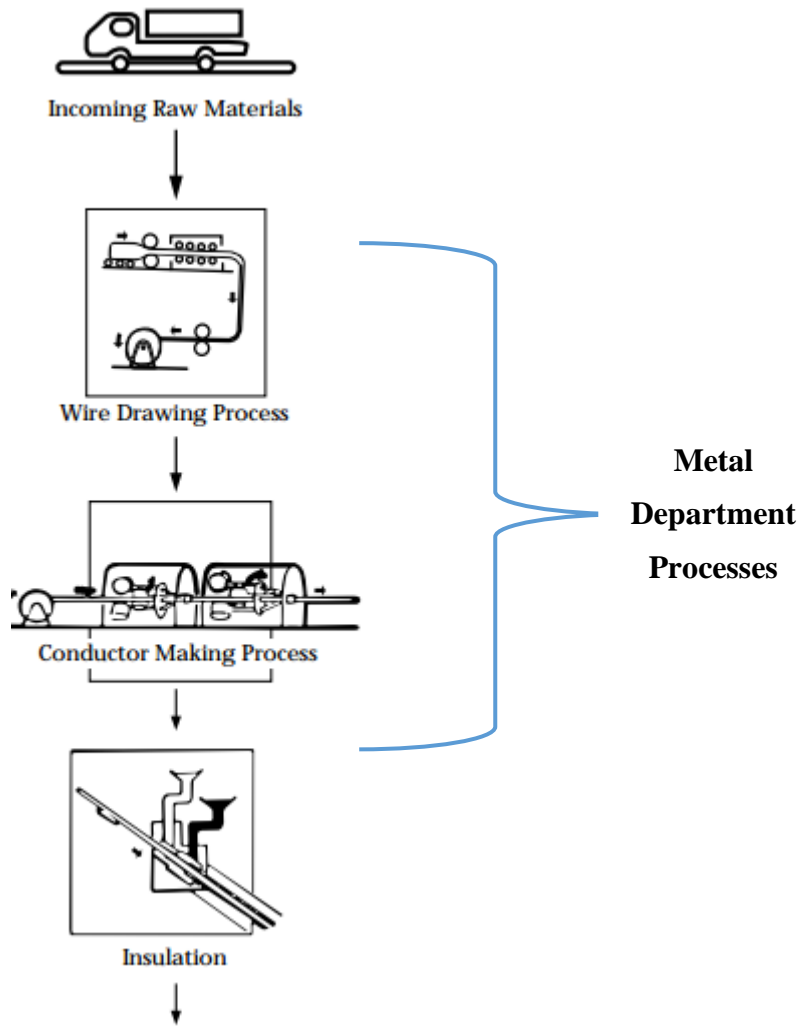


Figure 39. Metal department processes

[Redacted text block containing multiple lines of blacked-out content]

The final manufacturing operations that are directed by specific customer requirements, such as further manufacturing, finally assembly or packaging, are performed at some point downstream of the supply chain until a customer order has been received.

Form postponement (FP) involves the delay of final steps of manufacturing until a customer order is received. [29] This strategy is ideally located between the MTS and MTO approaches (Table 7.). With the MTS strategy, the production is based on demand forecast, in anticipation to customer orders and to replenish the stock of finished products. On the other extreme, with the MTO approach the production starts when a customer order is receipt. FP improves responsiveness compared to MTO, while still enabling a high level of customization. This means that the manufacturing usually starts depending on sales forecast, then the semi-finished product is submitted to further transformation processes only after customer orders are received. [29]

Table 7. Comparison between MTO, MTS and FP approaches

Features	Make To Stock	Form Postponement	Make To Order
Lead time	Short	Quite long	Long
Product mix	Low	High	High
Manufacturing driver	Forecast	Forecast (for the initial processes) and then customer order	Customer order

FP approach can be used instead of MTO when considering products having high-level demand; the goal is to reduce order lead-times and increases delivery reliability. Moreover, it allows to face high demand variability due to product proliferation by postponing and/or delaying the differentiation (Figure 40). [29]

Form Postponement (FP) strategy is characterized by a customer order decoupling point (CODP). The decoupling point is located in a position in the material pipeline where the product flow changes from “push” to “pull”. [30] It is also defined as “The point in the product axis to which the customer’s order penetrates.” It is where order driven and the forecast driven activities meet. As a rule, the Decoupling Point coincides with a stock point. [30] The governing principle is always to move the material decoupling point as close to the end of consumer as possible in order to ensure the shortest lead-time for the consumer.

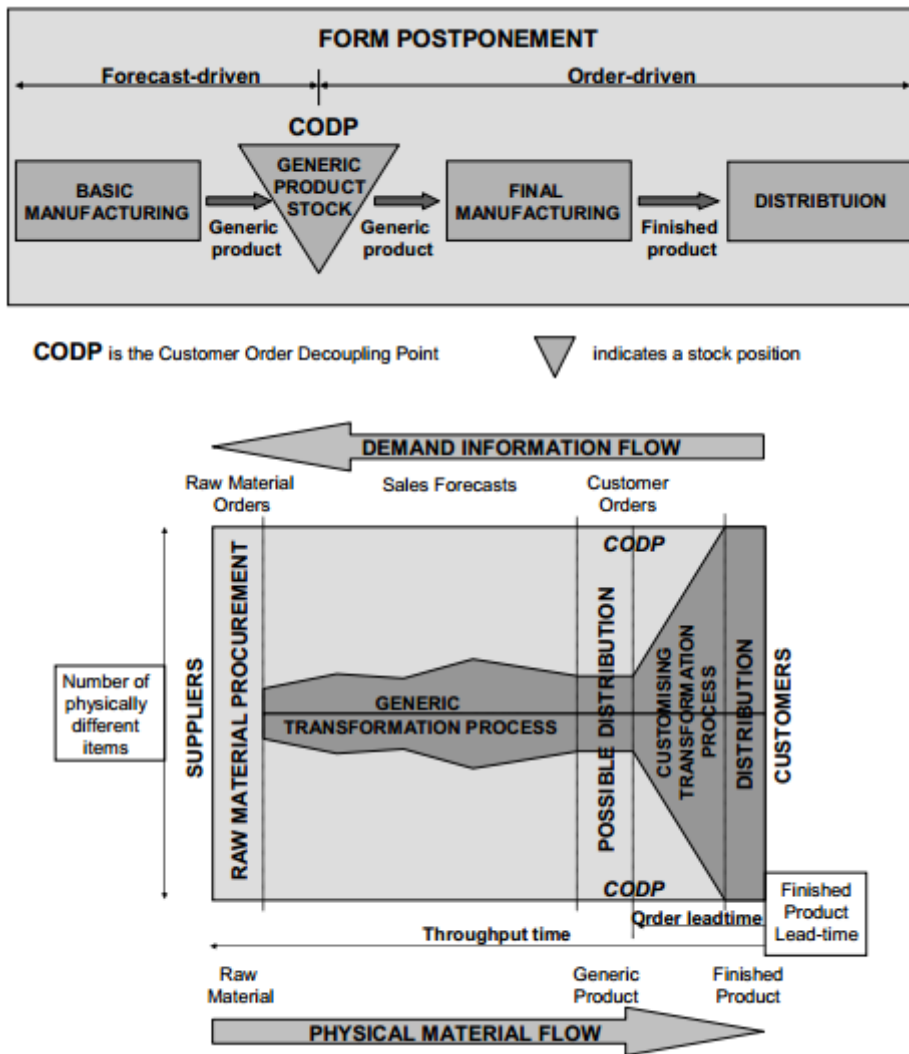
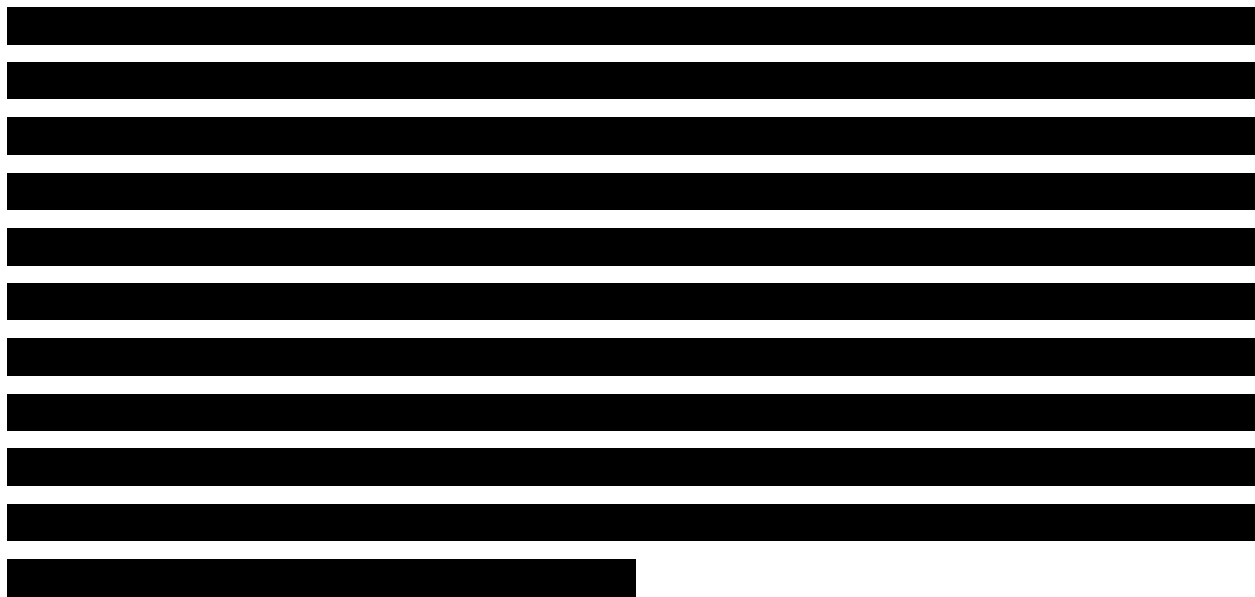


Figure 40. Conceptual model of Form Postponement strategy [35]



5.2. Utilization of machines and handling/transport vehicles

Production performed in a MTO strategy requires the respect of deadlines for all the orders received, even unpredicted. Simulation can be used with the purpose of cutting throughput time, as well as inventory, and enhancing the productivity of existing production facilities.

The first step of simulation is the formulation of problem. The factory is facing difficulties related with the high number of different types of products offered and the uncertainty on the demand. The real problem is studied in this research using a simulation model, which is the most suitable tool to investigate a complex system and to predict its behavior. It is so possible to analyze the current manufacturing system to individuate bottlenecks and the low utilization of the machinery, in order to introduce improvements and to evaluate the changes in performance related to different scenarios. Once defined the decision variables, simulation can help to find the best values for these variables by analyzing the outputs of the model.

The purpose is to optimize resource usage in order to make the production process more efficient, by reducing costs and improving productivity.

Utilization of a machines is indicated as the ratio between the annual load on particular machine and annual available time on a machine. [30]

This is useful to individuate bottleneck resources, which are at their full capacity and with utilization rate of the machine equal or higher than 100 %. These machines utilized to a high level do not have any extra available capacity and they cause high loss if being idle. The rest of the machines, the non-bottlenecks, can have some time during the year to stay idle without causing a loss for the production system (Figure 41.).

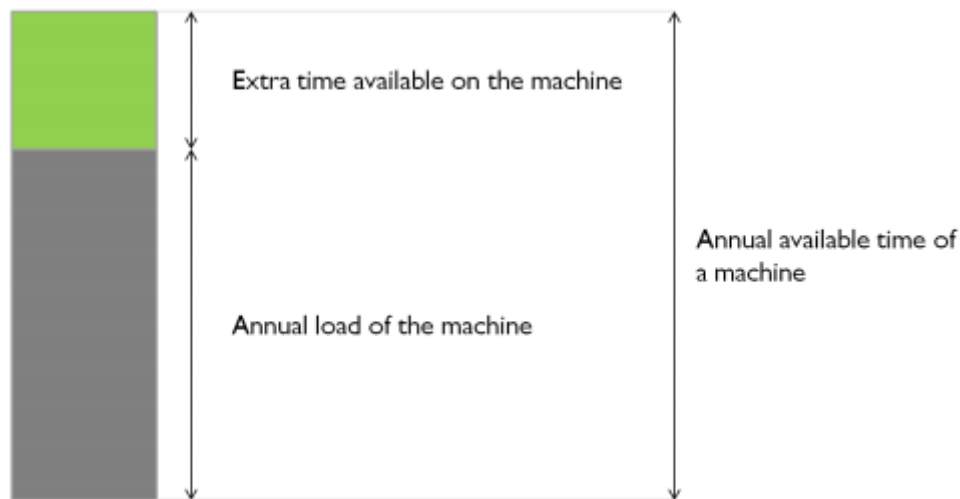


Figure 41. Available time for a machine

The different conditions (Figure 42.) for a particular resource (machine) are: [31]

- Working: the portion of the statistics collection period during which the object was working
- Setting-up: the portion of the statistics collection period during which the object was preparing for processing a different type of MU
- Waiting: the portion of the statistics collection period during which the object was waiting
- Blocked: the portion of the statistics collection period during which the object was fully occupied
- Powering up/down: the portion of the statistics collection period during which the object was changing its energy state
- Failed: the portion of the statistics collection period during which the object was not working due to a failure of any kind
- Stopped: the portion of the statistics collection period during which the object was stopped by a Lock-out Zone, that stops after a failure all the stations within the zone
- Paused: the portion of the statistics collection period during which the object was paused
- Unplanned: the portion of the statistics collection period during which the object was not scheduled to work to the statistics collection period.

Object	Working	Set-up	Waiting	Blocked	Powering up/down	Failed	Stopped	Paused	Unplanned	Portion
Source	0.00%	0.00%	0.00%	100.00%	0.00%	0.00%	0.00%	0.00%	0.00%	
SingleProc	99.98%	0.00%	0.00%	0.02%	0.00%	0.00%	0.00%	0.00%	0.00%	
Buffer	0.00%	0.00%	99.97%	0.03%	0.00%	0.00%	0.00%	0.00%	0.00%	
SingleProc1	97.16%	0.00%	0.01%	0.00%	0.00%	2.84%	0.00%	0.00%	0.00%	
SingleProc2	27.53%	0.00%	0.00%	0.00%	1.94%	0.20%	0.00%	0.00%	70.33%	
Buffer1	0.00%	0.00%	100.00%	0.00%	0.00%	0.00%	0.00%	0.00%	0.00%	
SingleProc3	97.15%	0.00%	2.85%	0.00%	0.00%	0.00%	0.00%	0.00%	0.00%	
Buffer11	0.00%	0.00%	100.00%	0.00%	0.00%	0.00%	0.00%	0.00%	0.00%	
SingleProc31	2.75%	0.00%	97.25%	0.00%	0.00%	0.00%	0.00%	0.00%	0.00%	

Green: working

Yellow: blocked

Brown: setting-up

Gray: waiting

Purple: powering up/down

Red: failed

Pink: stopped

Blue: paused

Light-blued: unplanned

Figure 42. Resource statistics collection for the period in STPS software

The idle time of a machine is the cumulative time when the machine is inactive, neither processing nor setting up the next production order. So, it is the time during which a resource is not fully utilized because of low demand or bottlenecks restraints. [32] Idle time has to be reduced because represents a source of waste and speed losses.

While idle time is considered a waste of time that needs to be eliminated, the set up times are necessary but they need to be reduced because of their significant effect on the total lead time. Related to the concept of the set up time there is the definition of batch, which is the number of flow units produced between two set-ups. [32] According to this, the capacity for a process is defined as how long it will take to produce one complete batch, and the formula is:

$$Capacity = \frac{Batch\ size}{(setup\ time + batch\ size * time\ per\ unit)}$$

Normally, the larger is the batch size, the more efficient is the production system, due to the possibility of using economics of scale. With large batch size, the set up times have less influence on the total time needed, but it lead to more inventory. On the other side, smaller batch size (the extreme is the one piece flow), increase the flexibility and the linearity of the process (Figure 43.).

However, a smaller batch size has a negative impact in capacity, due to the higher number of set up needed between different units; so, the reduction of the batch size has to be combined with the reduction of the set up times.

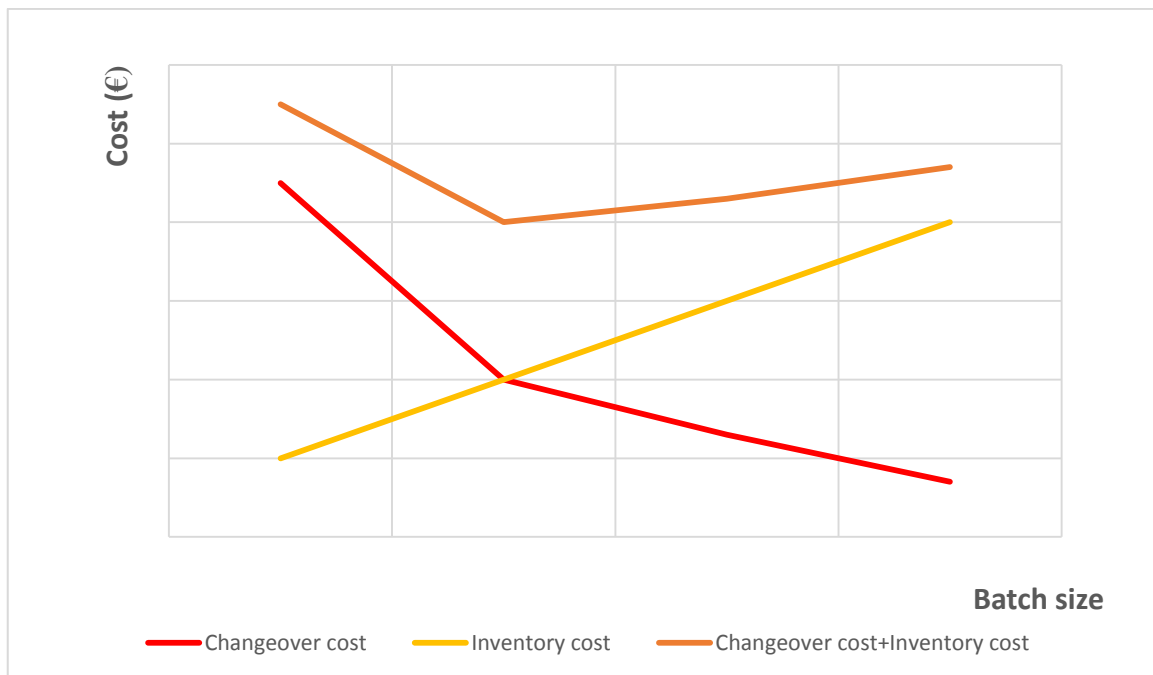


Figure 43. Optimal batch size

Two main product families will be considered in this work:

[REDACTED]

Another purpose of simulation is related to **material handling system**, in order to make experiments that can perform and control the flow of materials, for example to individuate bottlenecks or to find the optimal number of vehicles needed. In fact, transportation represents a source of waste because causes unnecessary movement of material either between the processes or point of use to the process. [33]

[Redacted text block]



Figure 44. Wooden drums for cables

[Redacted text block]



Figure 45. Forklift for spools transportation

In order to set up and to optimize the material handling system the input data needed are:

- Technological process of each product
- Type of vehicle used and parameters (speed, acceleration/deceleration, availability, time for charge/discharge, capacity)
- Layout distances (Table 8.)
- Material flow between different machines.

Table 8. Layout distances in meters between the machines

5.3. Choice of representative products

[Redacted text block]

[Redacted text block]

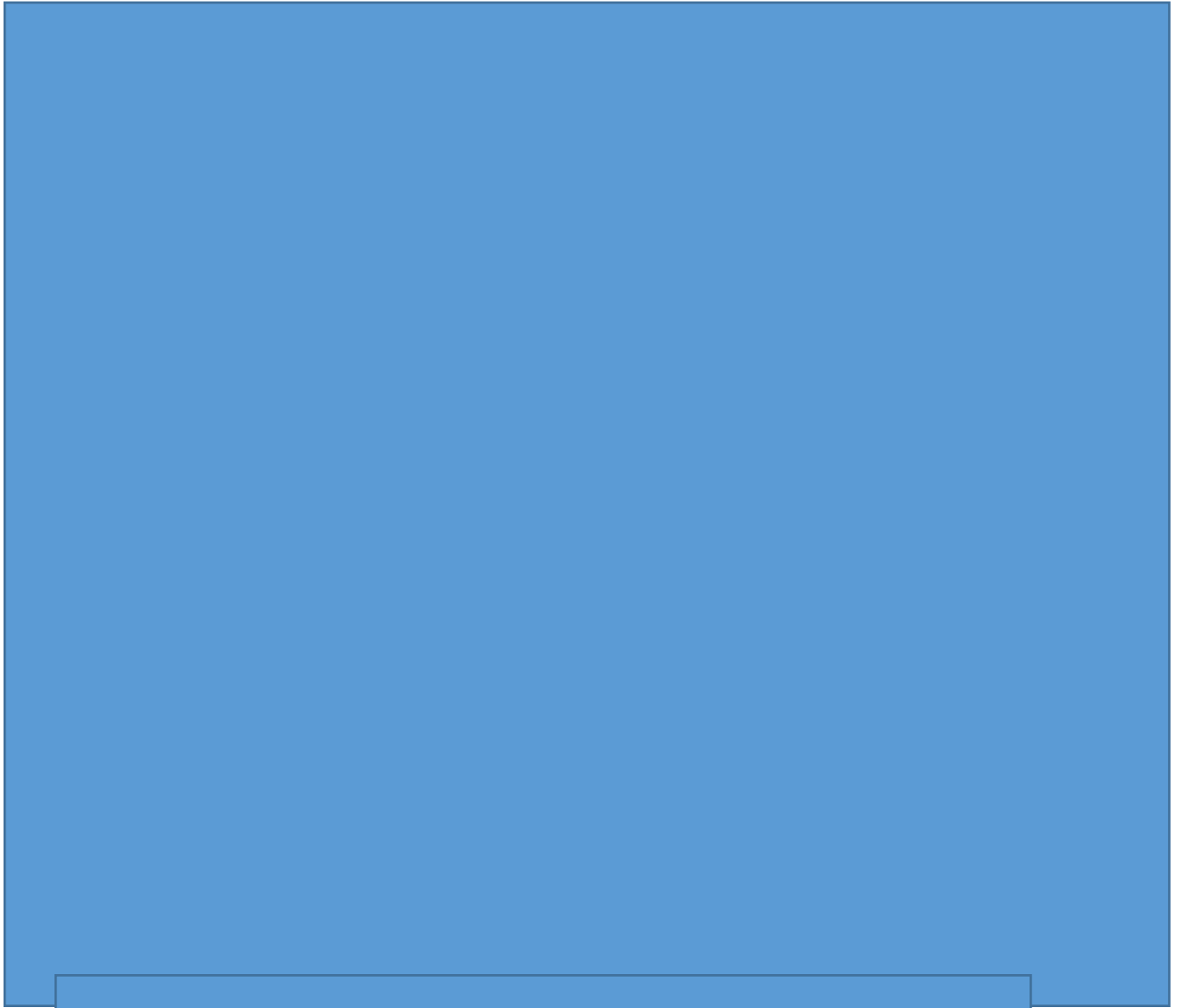
	[Redacted]	[Redacted]	[Redacted]
[Redacted]	[Redacted]	[Redacted]	[Redacted]
[Redacted]	[Redacted]	[Redacted]	[Redacted]

[Redacted text block]

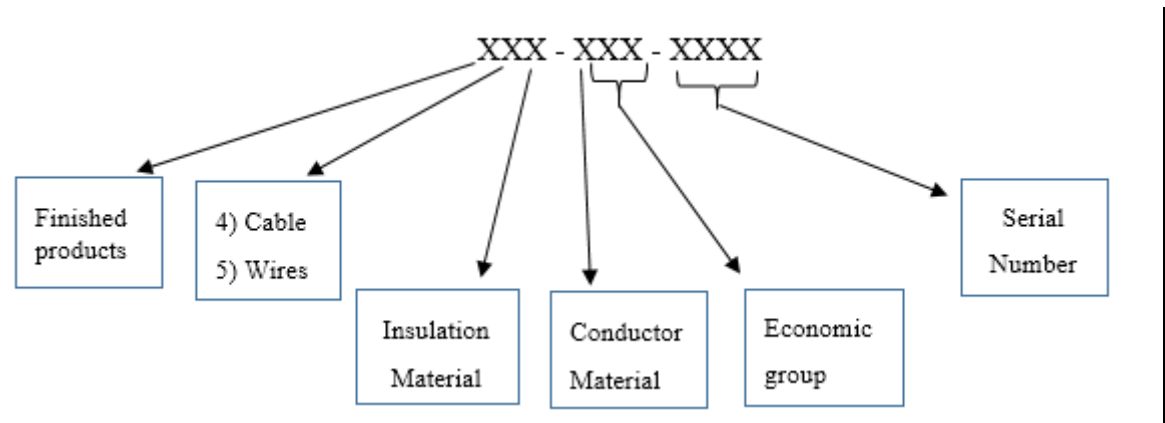
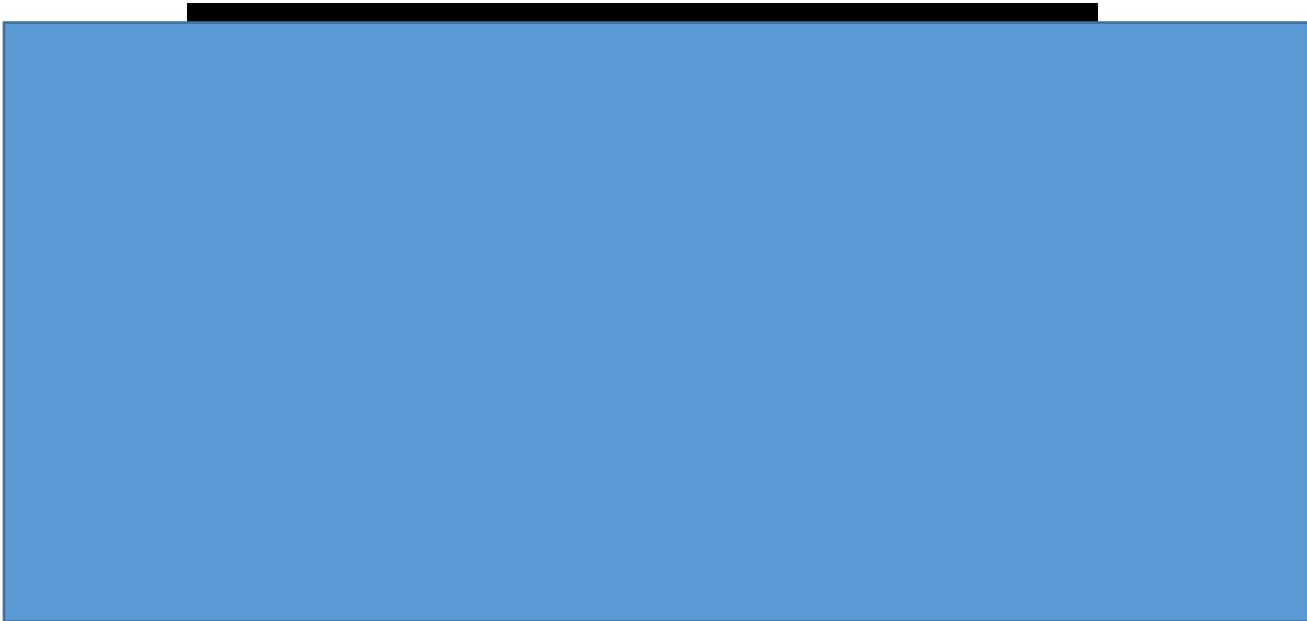
[Redacted text block]

[Redacted text block]

[Redacted]



[Redacted]



[REDACTED]

[REDACTED]

[REDACTED]

[REDACTED]

[REDACTED]

[REDACTED]

[REDACTED]	[REDACTED]	[REDACTED]	[REDACTED]	[REDACTED]
[REDACTED]	[REDACTED]	[REDACTED]	[REDACTED]	[REDACTED]

[REDACTED]

[REDACTED]	[REDACTED]	[REDACTED]	[REDACTED]	[REDACTED]	[REDACTED]
[REDACTED]	[REDACTED]	[REDACTED]	[REDACTED]	[REDACTED]	[REDACTED]
[REDACTED]	[REDACTED]	[REDACTED]	[REDACTED]	[REDACTED]	[REDACTED]

[REDACTED]

[REDACTED]	[REDACTED]	[REDACTED]	[REDACTED]	[REDACTED]	[REDACTED]
[REDACTED]	[REDACTED]	[REDACTED]	[REDACTED]	[REDACTED]	[REDACTED]
[REDACTED]	[REDACTED]	[REDACTED]	[REDACTED]	[REDACTED]	[REDACTED]

[REDACTED]

[REDACTED]	[REDACTED]	[REDACTED]	[REDACTED]	[REDACTED]	[REDACTED]
[REDACTED]	[REDACTED]	[REDACTED]	[REDACTED]	[REDACTED]	[REDACTED]
[REDACTED]	[REDACTED]	[REDACTED]	[REDACTED]	[REDACTED]	[REDACTED]

[REDACTED]

[REDACTED]	[REDACTED]	[REDACTED]	[REDACTED]	[REDACTED]
[REDACTED]	[REDACTED]	[REDACTED]	[REDACTED]	[REDACTED]

[REDACTED]

[REDACTED]	[REDACTED]	[REDACTED]	[REDACTED]	[REDACTED]	[REDACTED]
[REDACTED]	[REDACTED]	[REDACTED]	[REDACTED]	[REDACTED]	[REDACTED]
[REDACTED]	[REDACTED]	[REDACTED]	[REDACTED]	[REDACTED]	[REDACTED]
[REDACTED]	[REDACTED]	[REDACTED]	[REDACTED]	[REDACTED]	[REDACTED]

[REDACTED]

[REDACTED]	[REDACTED]	[REDACTED]	[REDACTED]	[REDACTED]	[REDACTED]
[REDACTED]	[REDACTED]	[REDACTED]	[REDACTED]	[REDACTED]	[REDACTED]
[REDACTED]	[REDACTED]	[REDACTED]	[REDACTED]	[REDACTED]	[REDACTED]

[REDACTED]

[REDACTED]	[REDACTED]	[REDACTED]	[REDACTED]	[REDACTED]	[REDACTED]
[REDACTED]	[REDACTED]	[REDACTED]	[REDACTED]	[REDACTED]	[REDACTED]
[REDACTED]	[REDACTED]	[REDACTED]	[REDACTED]	[REDACTED]	[REDACTED]

[REDACTED]

[REDACTED]	[REDACTED]	[REDACTED]	[REDACTED]	[REDACTED]	[REDACTED]
[REDACTED]	[REDACTED]	[REDACTED]	[REDACTED]	[REDACTED]	[REDACTED]

[REDACTED]	[REDACTED]	[REDACTED]	[REDACTED]	[REDACTED]	[REDACTED]
------------	------------	------------	------------	------------	------------

[REDACTED]

[REDACTED]	[REDACTED]	[REDACTED]
[REDACTED]	[REDACTED]	[REDACTED]
[REDACTED]	[REDACTED]	[REDACTED]

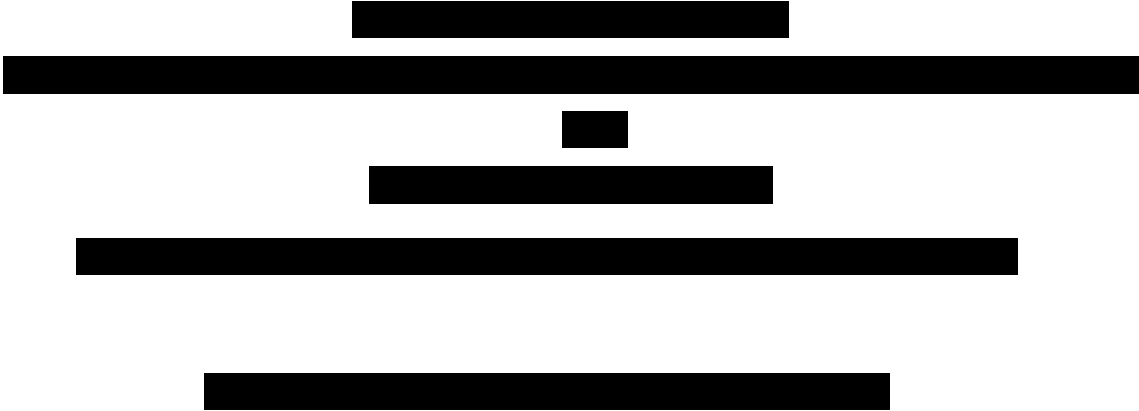


[REDACTED]

[REDACTED]

[REDACTED]

[REDACTED]



[REDACTED]

[REDACTED]	[REDACTED]	[REDACTED]	[REDACTED]	[REDACTED]	[REDACTED]
[REDACTED]	[REDACTED]	[REDACTED]	[REDACTED]	[REDACTED]	[REDACTED]
[REDACTED]	[REDACTED]	[REDACTED]	[REDACTED]	[REDACTED]	[REDACTED]

[REDACTED]

[REDACTED]	[REDACTED]	[REDACTED]	[REDACTED]	[REDACTED]	[REDACTED]
[REDACTED]	[REDACTED]	[REDACTED]	[REDACTED]	[REDACTED]	[REDACTED]
[REDACTED]	[REDACTED]	[REDACTED]	[REDACTED]	[REDACTED]	[REDACTED]

[REDACTED]

[REDACTED]	[REDACTED]	[REDACTED]	[REDACTED]	[REDACTED]	[REDACTED]
[REDACTED]	[REDACTED]	[REDACTED]	[REDACTED]	[REDACTED]	[REDACTED]

[REDACTED]

[REDACTED]	[REDACTED]	[REDACTED]	[REDACTED]	[REDACTED]
[REDACTED]	[REDACTED]	[REDACTED]	[REDACTED]	[REDACTED]

[REDACTED]

[REDACTED]	[REDACTED]	[REDACTED]	[REDACTED]	[REDACTED]	[REDACTED]
[REDACTED]	[REDACTED]	[REDACTED]	[REDACTED]	[REDACTED]	[REDACTED]

[REDACTED]

[REDACTED]	[REDACTED]	[REDACTED]	[REDACTED]	[REDACTED]	[REDACTED]
[REDACTED]	[REDACTED]	[REDACTED]	[REDACTED]	[REDACTED]	[REDACTED]
[REDACTED]	[REDACTED]	[REDACTED]	[REDACTED]	[REDACTED]	[REDACTED]
[REDACTED]	[REDACTED]	[REDACTED]	[REDACTED]	[REDACTED]	[REDACTED]

[REDACTED]

[REDACTED]	[REDACTED]	[REDACTED]
[REDACTED]	[REDACTED]	[REDACTED]
[REDACTED]	[REDACTED]	[REDACTED]
[REDACTED]	[REDACTED]	[REDACTED]
[REDACTED]	[REDACTED]	[REDACTED]
[REDACTED]	[REDACTED]	[REDACTED]
[REDACTED]	[REDACTED]	[REDACTED]
[REDACTED]	[REDACTED]	[REDACTED]

6. THE SIMULATION SOFTWARE: SIEMENS (TECNOMATIX) PLANT SIMULATION

Siemens (Tecnomatix) Plant Simulation (STPS) is a standard software for object-oriented, graphical, and integrated modeling, for simulating and visualizing systems and business processes (Figure 51.). It is a discrete, event-controlled simulation program, which only considers points in time (events) essential to the further course of the simulation. Thus, the simulation time that the EventController displays, leaps from event to event. When a part enters a material flow object, it is calculated the time until it exits, and it is registered an exit event in the list of events for this point of time. [31]

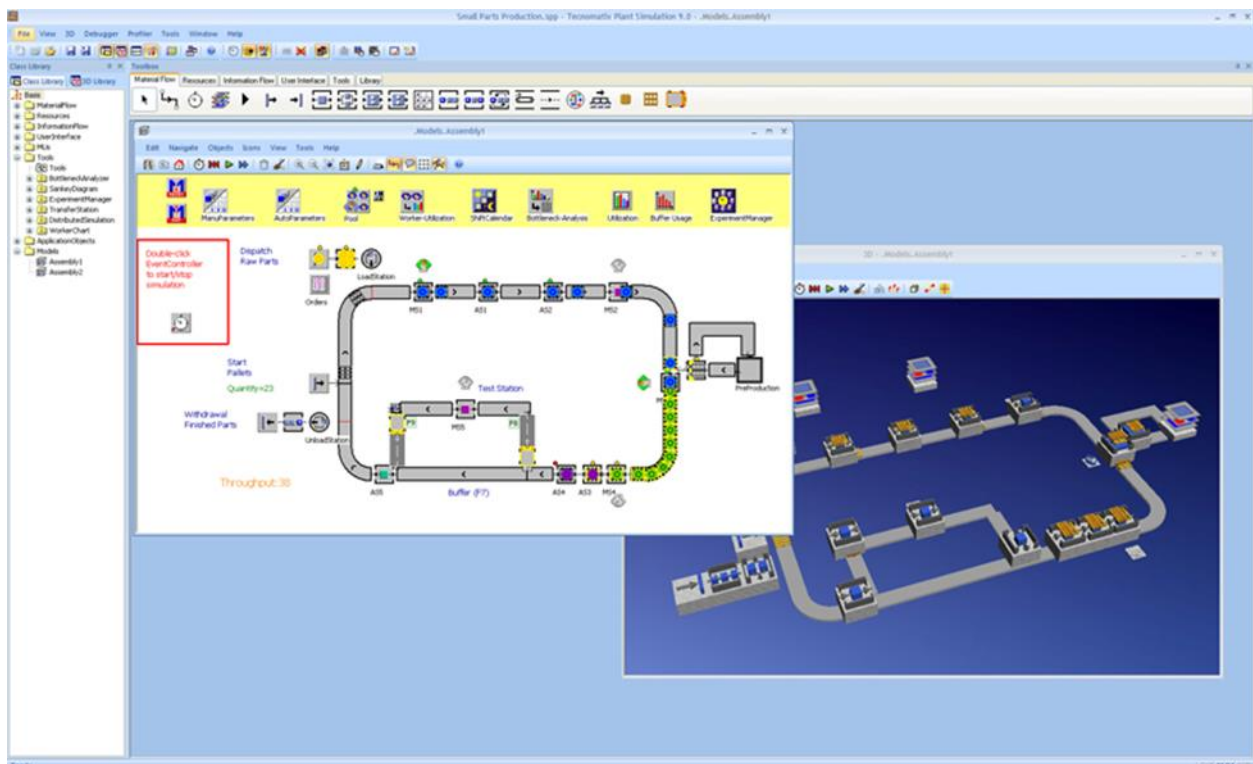


Figure 51. Modeling 2D and 3D simulation in Siemens (Tecnomatix) Plant Simulation

In general, the aim of simulation is to enable managers to make objective decisions by dynamic analysis, to safely plan and, in the end, to reduce cost. Thus, when real systems and plants are too expensive for conducting experiments and the time to conduct trials is limited, modeling, simulation and animation are excellent tools for analyzing and optimizing time dynamic processes (Table 32.).

Plant simulation offers the possibility to create a model by inserting instances of the built-in objects from the ClassLibrary into the object Frame in the folder Model (Figure 52.). The Frame is the object in which the simulation model is created and an EventController is inserted; it starts, stops and resets the simulation run. By using the sophisticated software suite, it is possible to design and simulate complete production lines with machine tools and robot cells as well as material handling and transport systems. [31] The challenge is to improve the production system by re-arranging factory floor layouts and optimizing machine utilization with the goal of accelerating production cycles and saving investment costs.

Tecnomatix Plant Simulation allows to build a digital useful to run experiments and what-if scenarios to explore logistic systems and their processes without disturbing them, or - when used in the planning process – long before the real production systems are installed. [26]

Table 32. Key capabilities and benefits of Siemens (Tecnomatix) Plant Simulation

Key capabilities	Benefits
Object-oriented models with hierarchy and inheritance	As much as 6 % savings upon initial investment
Open architecture with multiple interface support	Increase existing system productivity by as much as 20 %
Library and object management	Reduce new system costs by as much as 20 %
Genetics algorithm for optimization	Optimize resource consumption and re-use
Energy consumption simulation and analysis	Reduce inventories by as much as 60 %
Value stream mapping and simulation	Reduce throughput time by as much as 60 %
Automatic analysis of simulation results	Optimize systems for reduced energy consumption

In Plant Simulation the standard classes can be classified into six categories:

1. Material flow objects
2. Resources
3. Mobile objects
4. Information flow objects (lists and tables)
5. Display and user-interface objects.

Mobile and static material flow objects are the basic objects of a model. The mobile units⁹ (transporters, containers or parts) are the objects that move through a model and they can be transported by active or passive material flow objects. Active material objects are for example Single or Parallel processes, Assembly or Dismantle stations, Line or Angular converter; passive material flow objects are Store, Track and TwolaneTrack that do not pass on the MUs automatically. [31]

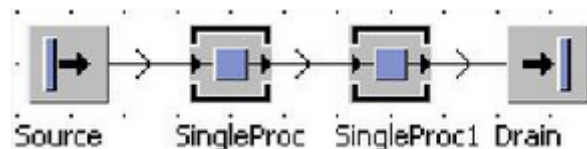


Figure 52. Example of a basic Frame in STPS

The source creates mobile objects according to the defined strategy: it is possible to create different parts and to choose the batches size and the production times. In fact, by setting the Time of creation the options are: [31]

- Interval adjustable: the production dates are determined by start, stop and the interval. It means that the first part is produced at start and other parts are produced at an interval, until the stop.
- Number adjustable: number and interval determine the production dates (a certain number at a specified interval); so it is necessary to define both creation times and amount
- Delivery table: there is a table that contains the details of production order (parts type and production times).

The drain destroys the MU after processing them and it is useful to collect statistical data, such as total throughput, throughput per hour and per day, or number of destroyed parts.

⁹ MUs

The single process accepts exactly one MU from its predecessors, so when a MU is processed the object is full and other newly arriving will be blocked. If the MU has several successors, it will be transferred to the next free object.

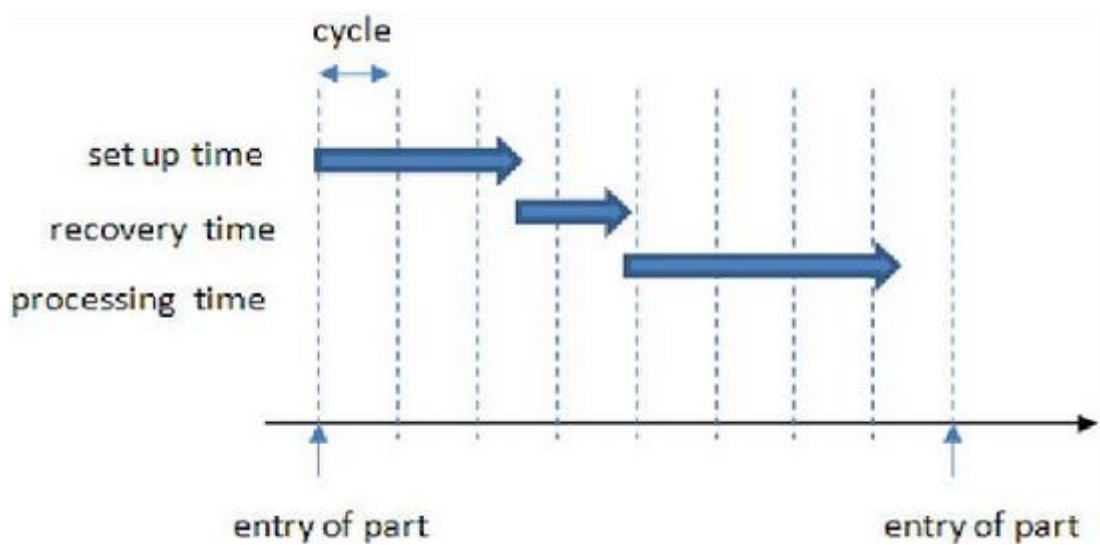


Figure 53. Processing duration of a part on a station in STPS

The processing duration (Figure 53.) of a part on a station consists of three parts:

- **Set up time:** it is the time required to set up an object when it is necessary to process another type. The set up time depends on the MU name, but it is also possible to schedule a set up after a certain number of parts, for example for tool changes.
- **Recovery time:** it is the time required to set a station into a defined state before it can start processing the next part. The recovery time is useful to model materials handling equipment, such as a robot, which requires a certain time to insert work pieces into or remove them from processing stations.
- **Processing time:** it determines how long an MU stays on the object after the set up time and before the object moves the processed part on to its successor.

The cycle time is used for synchronizing the production and specifies in which multiple of an interval the entrance of a material flow object opens and closes. It means that although the previous station is ready earlier, the part must wait until the cycle is over before being transferred to the successor. The cycle time is useful to model chain conveyors with a fixed chain interval that only transport materials when a free hook is available. [26]

Some analysis tools, such as bottleneck analysis (Figure 54.), statistics and charts (Figure 57.) (Figure 58.) (Figure 59.) are useful to evaluate different manufacturing scenarios and to get all the information needed to improve the process and to make reliable and smarter decisions.

The Bottleneck Analyzer displays the statistics of the material flow objects and sorts the data into a table. It is possible to individuate the machine or the machines causing the bottleneck that will have a high working portion and the goal is trying to make them faster in order to increase the throughput of the entire system.

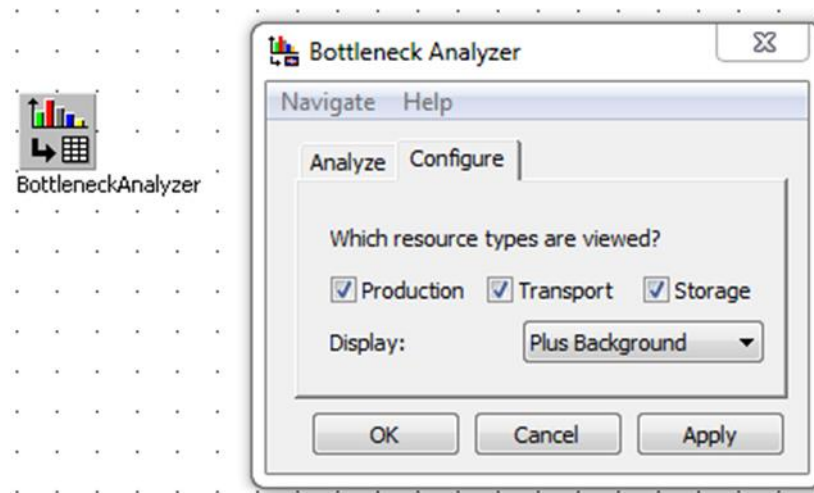


Figure 54. Bottleneck Analyzer in STPS

The Sankey Diagram can be represented in 2D or in 3D and it displays instantiated MUs of MU classes (Figure 62.). It allows the user to easily interpret the results of the simulation runs by visualizing the flow of material and to draw the right conclusions (Figure 56.). The thicker the Sankey streams between two stations, the more MUs have been transported on the connectors between these stations. [31]

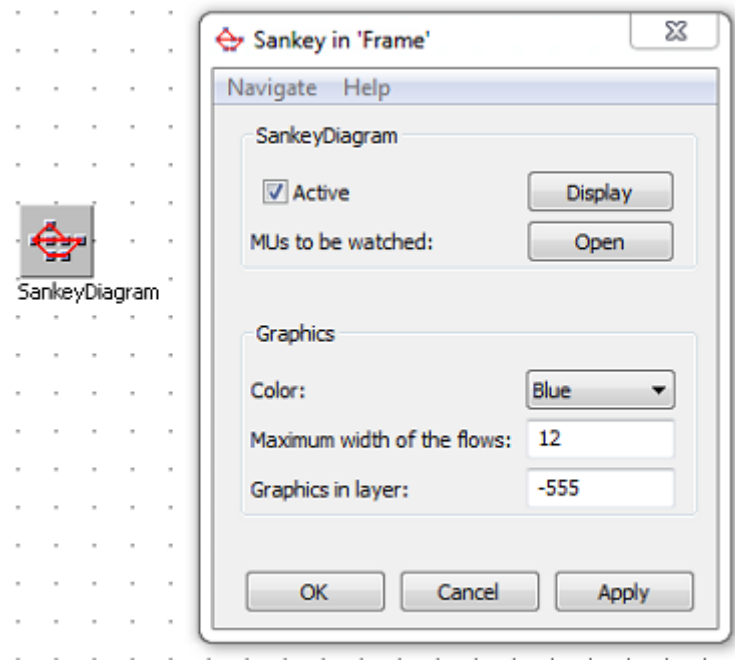


Figure 55. Sankey's Diagram in STPS

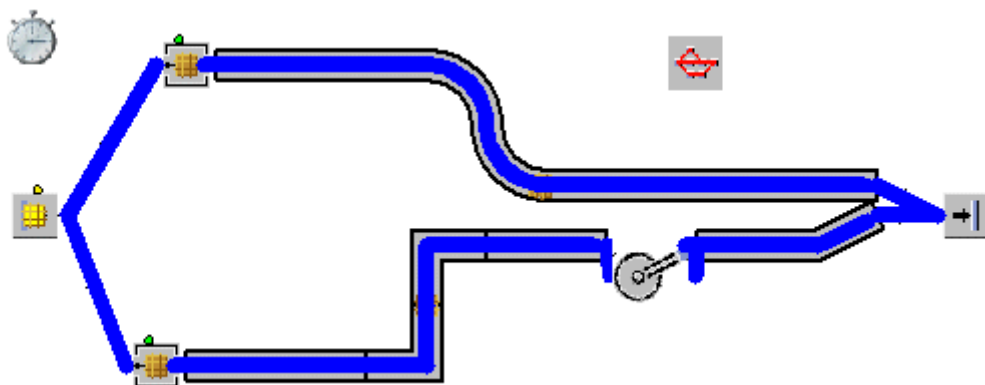


Figure 56. Flow of material with Sankey's Diagram in STPS

The Chart graphically displays the data recorded during the simulation. It is possible to select the type of resources for which showing statistical data of the selected objects in the chart. The selection for the statistics type is between Resource statistics, Energy statistics, or Occupancy. For example, the Resource statistics chart (Figure 57.) shows on percentage the amount of effort contributed by each resource in terms of work time and the amount of time in which the resource is not working for several reasons that are indicated by different colors.

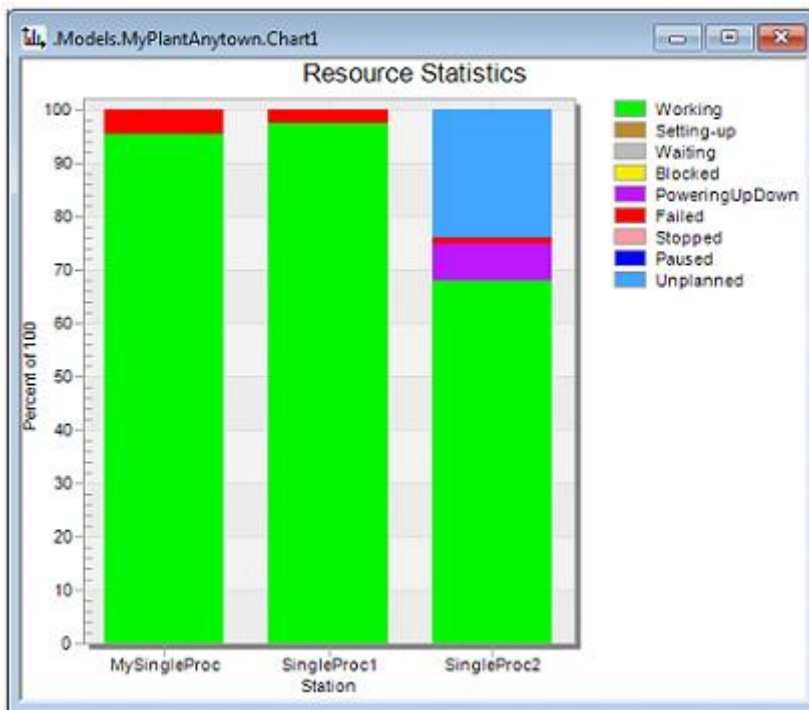


Figure 57. Resource statistics chart in STPS

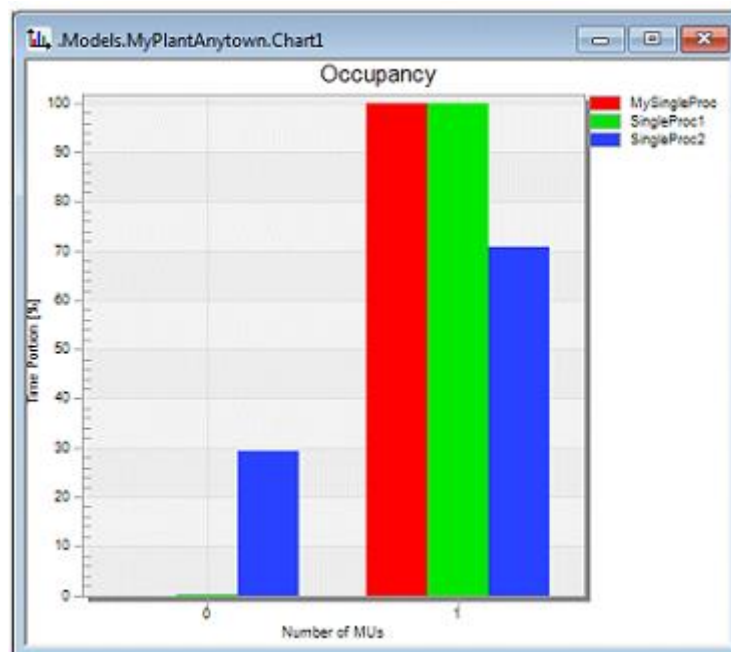


Figure 58. Occupancy statistics chart in STPS

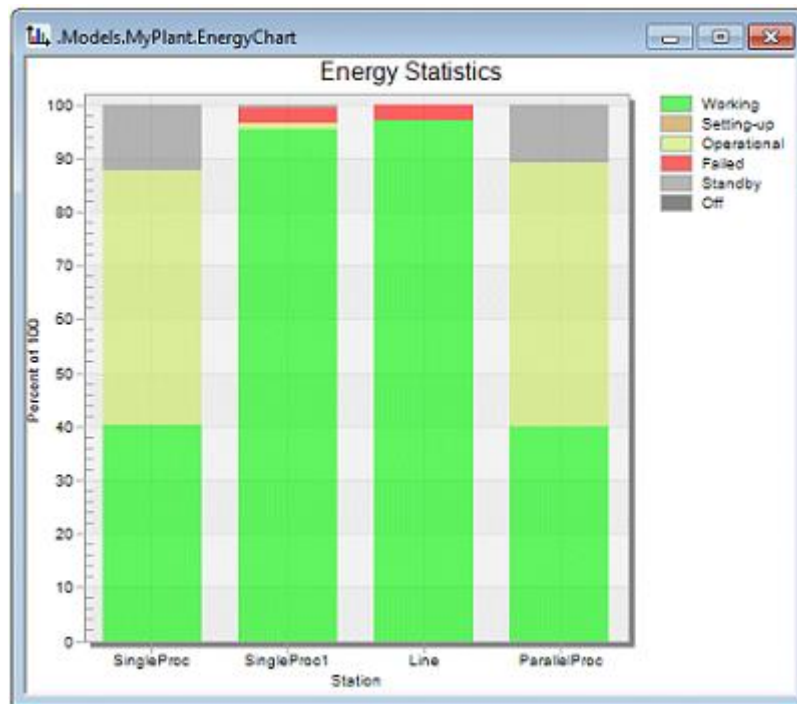


Figure 59. Energy statistics chart in STPS

The use of these interfacing tools makes easier the analysis of simulation results and the evaluation of different alternatives according some measures of performance, like makespan¹⁰, throughput or utilization of resources. In fact, such details are difficult to get manually and by using simulation software all the information about processes can be collected easily and this makes faster the introduction of improvements and the decision making process. [31]

¹⁰ In manufacturing, the time difference between the start and finish of a sequence of jobs or tasks. [34]

7. THE MAKING OF THE SIMULATION MODEL AND THE RESULTS

7.1. The simulation model

[REDACTED]

[Redacted]

[Redacted]	[Redacted]	[Redacted]	[Redacted]
[Redacted]	[Redacted]	[Redacted]	[Redacted]
[Redacted]	[Redacted]	[Redacted]	[Redacted]
[Redacted]	[Redacted]	[Redacted]	[Redacted]
[Redacted]	[Redacted]	[Redacted]	[Redacted]
[Redacted]	[Redacted]	[Redacted]	[Redacted]

[Redacted]

[Redacted]

[Redacted]

[Redacted]

[Redacted]

[Redacted]

[Redacted]

[Redacted]

[Redacted]

[Redacted]

[Redacted]

[Redacted]

[Redacted]

[Redacted]

[Redacted]

[Redacted]

[Redacted]

[Redacted]

[Redacted]

[Redacted]

[Redacted]

[Redacted]

[Redacted]

[Redacted]

[Redacted]

[Redacted]

[Redacted text block]

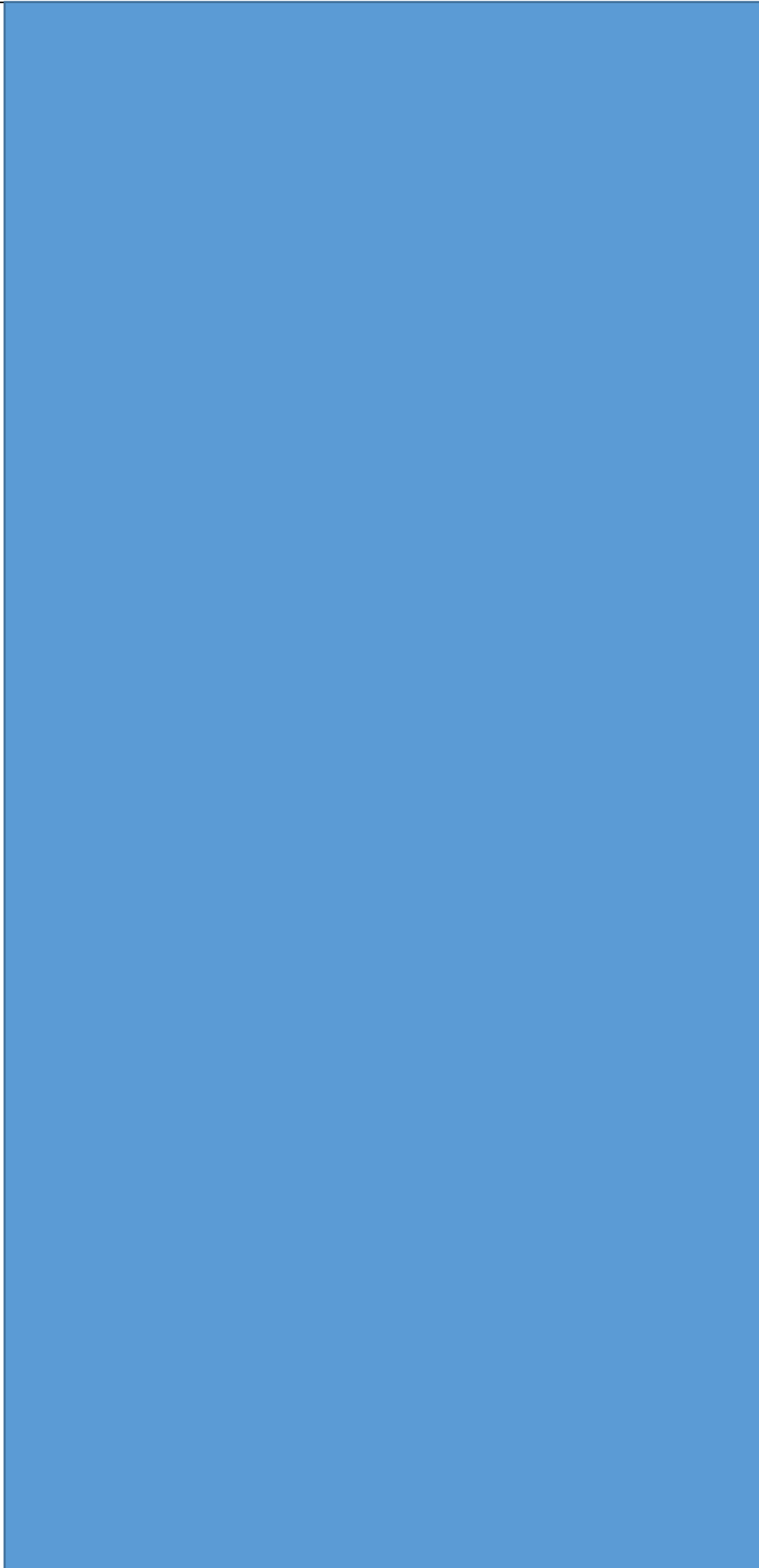
[Redacted text block]

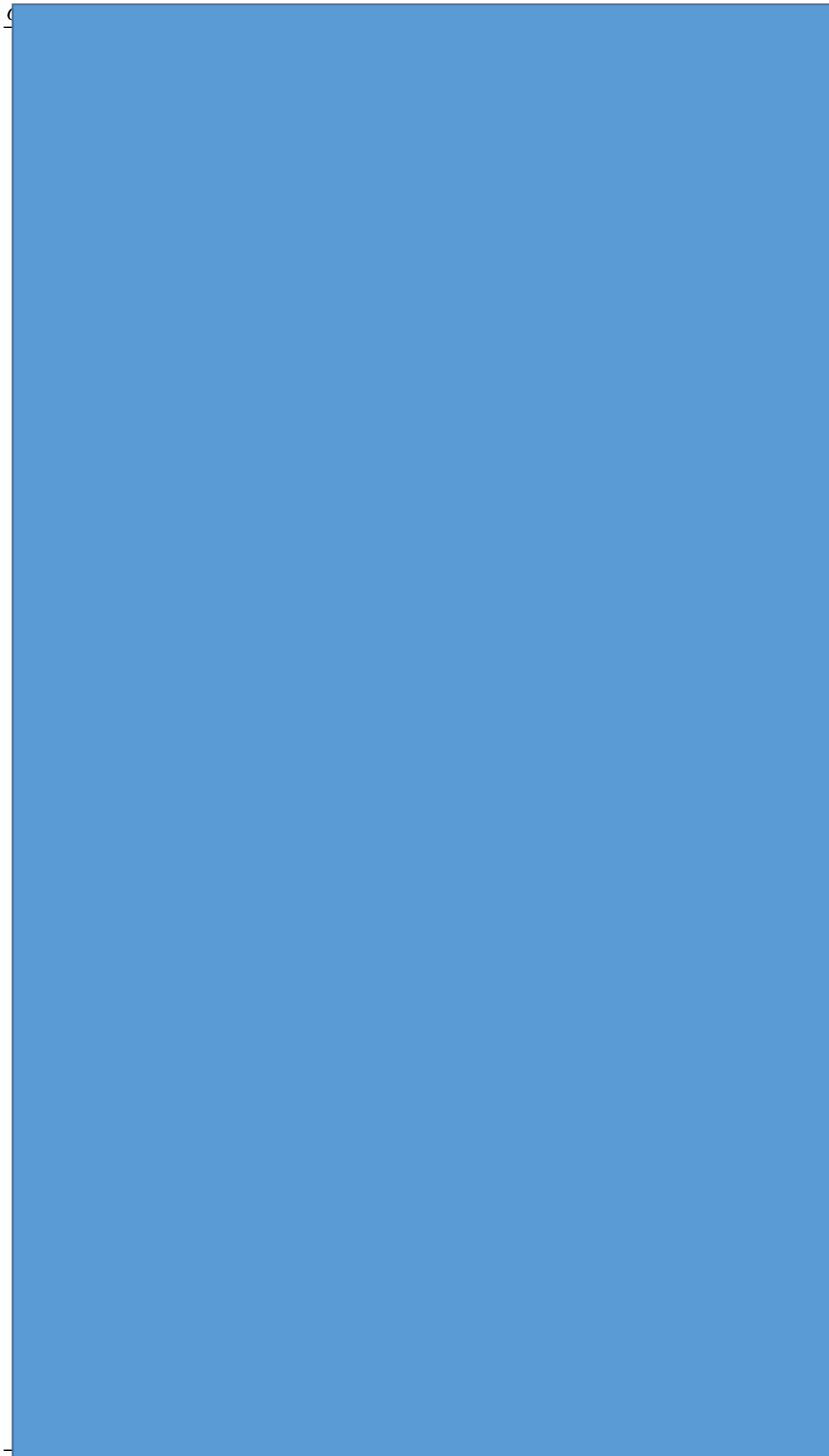
[Redacted text block]

[Redacted text block]

[Redacted]	[Redacted]	[Redacted]	[Redacted]	[Redacted]	[Redacted]	[Redacted]	[Redacted]
[Redacted]	[Redacted]	[Redacted]	[Redacted]	[Redacted]	[Redacted]	[Redacted]	[Redacted]

[Redacted text block]





[Redacted text block]

[Redacted text block]

[Redacted text block]

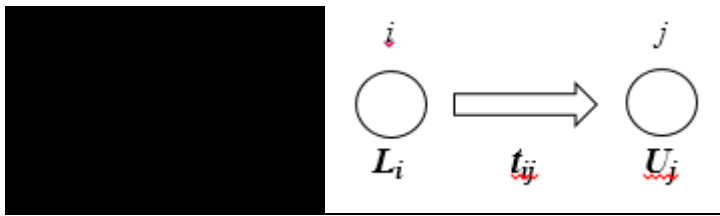
[Redacted]	[Redacted]	[Redacted]	[Redacted]	[Redacted]
[Redacted]	[Redacted]	[Redacted]	[Redacted]	[Redacted]
[Redacted]	[Redacted]	[Redacted]	[Redacted]	[Redacted]
[Redacted]	[Redacted]	[Redacted]	[Redacted]	[Redacted]
[Redacted]	[Redacted]	[Redacted]	[Redacted]	[Redacted]
[Redacted]	[Redacted]	[Redacted]	[Redacted]	[Redacted]
[Redacted]	[Redacted]	[Redacted]	[Redacted]	[Redacted]
[Redacted]	[Redacted]	[Redacted]	[Redacted]	[Redacted]
[Redacted]	[Redacted]	[Redacted]	[Redacted]	[Redacted]







[Redacted text block consisting of multiple lines of blacked-out content]



[Redacted text block]

[Redacted text block]

[Redacted text block]

[Redacted text block]

[Redacted text block]

[Redacted text block]

[Redacted text block]

[Redacted text block]

[Redacted text block]

[Redacted text block]

[Redacted text block]

[Redacted text block]

[Redacted text block]

[Redacted text block]

[Redacted text block]

[Redacted text block]

[Redacted text block]

[Redacted text block]

[Redacted text block]

[Redacted text block]

[Redacted]

[Redacted]

[Redacted]

[Redacted]

[Redacted]

[Redacted]

[Redacted]

[Redacted]

[Redacted]

[Redacted]

[Redacted]

[Redacted]

[Redacted]

[Redacted]

[Redacted]

[Redacted]

[Redacted]

[Redacted]

[Redacted]

[Redacted]

[Redacted]

[Redacted]

[Redacted]

[Redacted]

[Redacted]

[Redacted]

[Redacted]

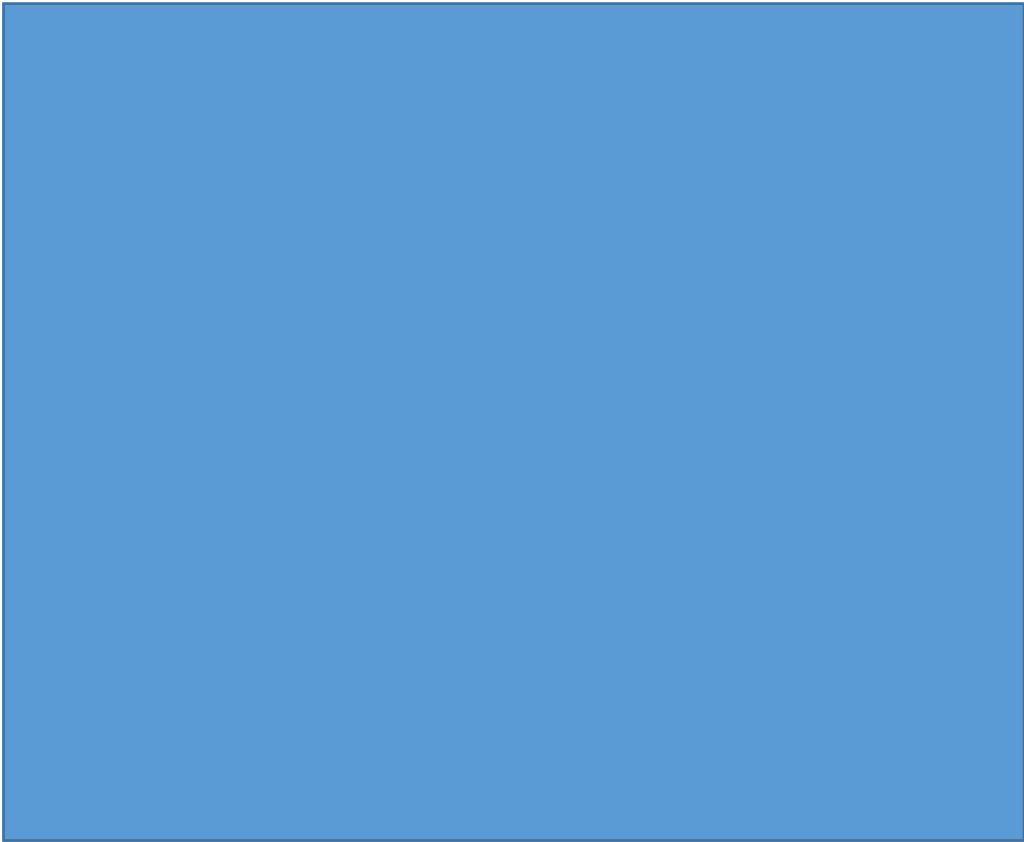
[Redacted]

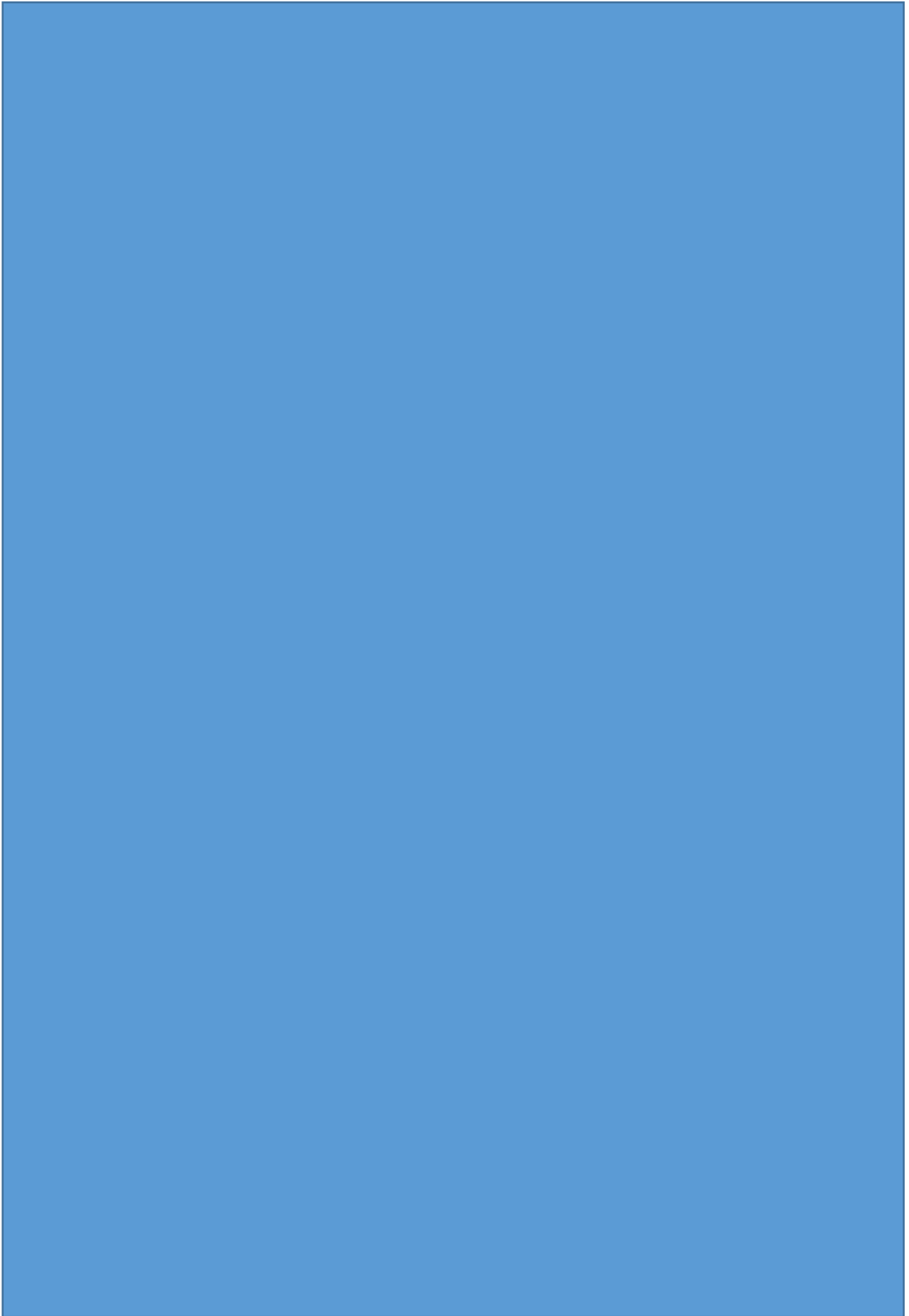


Figure 65. shows the utilization of machines for the alternative 1 which considers just MTO products. The percentage of working (green column) indicates how often the object was processing a MU.

Figure 66. shows the working time and set up time for each machine, it means the total time during which the object was working or setting up. The statistic report provides details about:

- Portion = the portion of the statistics period during which the object worked or setting-up
- Count = how often the object worked or set up
- Sum = the total time during which the object worked or set up
- Mean Value = the mean duration of the time spans during which the object worked or set up
- Standard Deviation the standard deviation of the time spans during which the object worked or set up from the mean value. [31]





[Redacted]

[Redacted]

[Redacted]

[Redacted]

[Redacted]	[Redacted]	[Redacted]	[Redacted]	[Redacted]
[Redacted]	[Redacted]	[Redacted]	[Redacted]	[Redacted]
[Redacted]	[Redacted]	[Redacted]	[Redacted]	[Redacted]
[Redacted]	[Redacted]	[Redacted]	[Redacted]	[Redacted]
[Redacted]	[Redacted]	[Redacted]	[Redacted]	[Redacted]
[Redacted]	[Redacted]	[Redacted]	[Redacted]	[Redacted]
[Redacted]	[Redacted]	[Redacted]	[Redacted]	[Redacted]

[Redacted]

[Redacted]

[Redacted]

[Redacted]

[Redacted]

[Redacted]

[Redacted]

[Redacted]

[Redacted]

[Redacted]

[Redacted]

[Redacted]

[Redacted]

[Redacted]

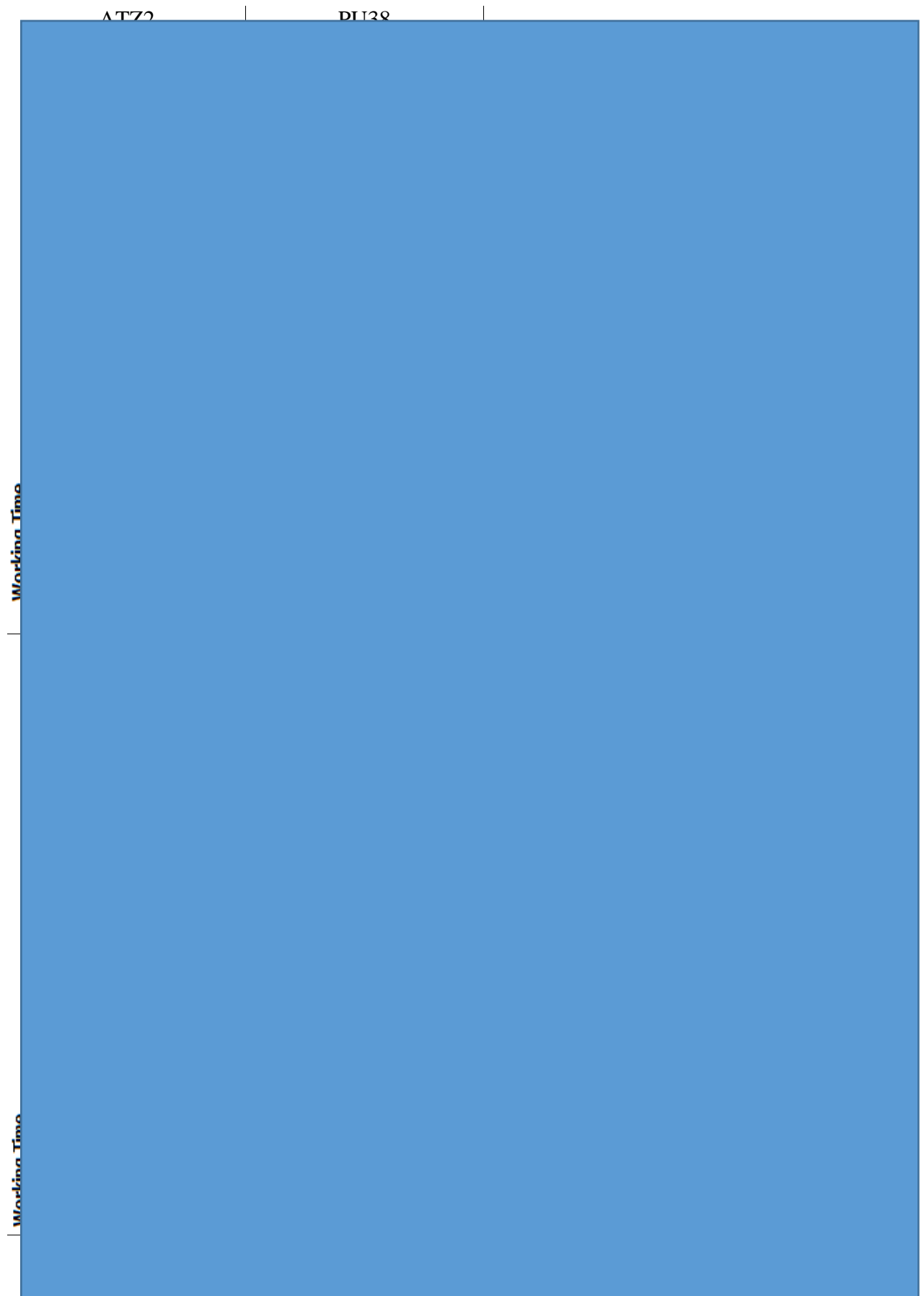
[Redacted]

[Redacted]

[Redacted]

[Redacted]

[REDACTED]



2) Number of batches = Number of orders $\times 1.1$

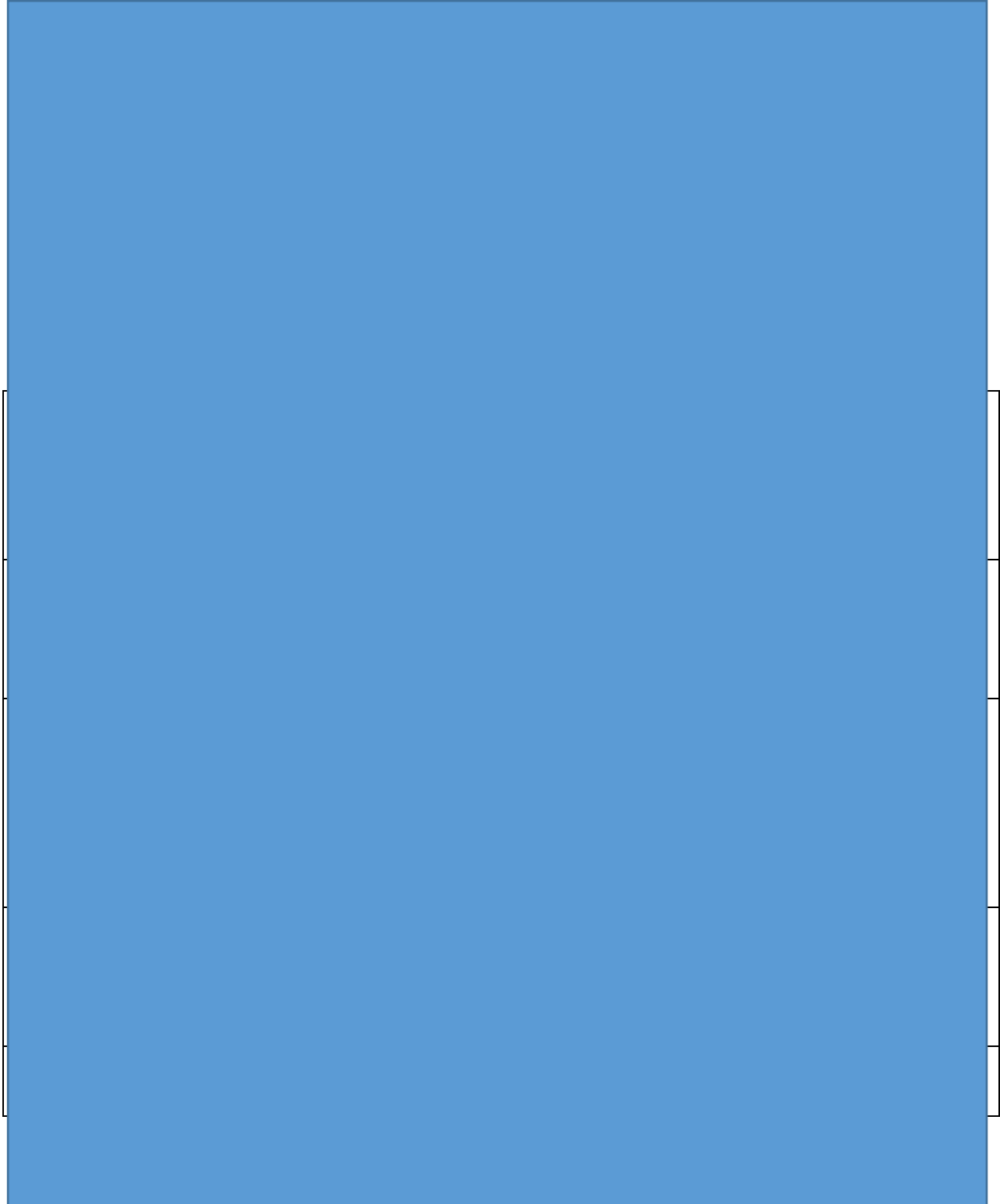
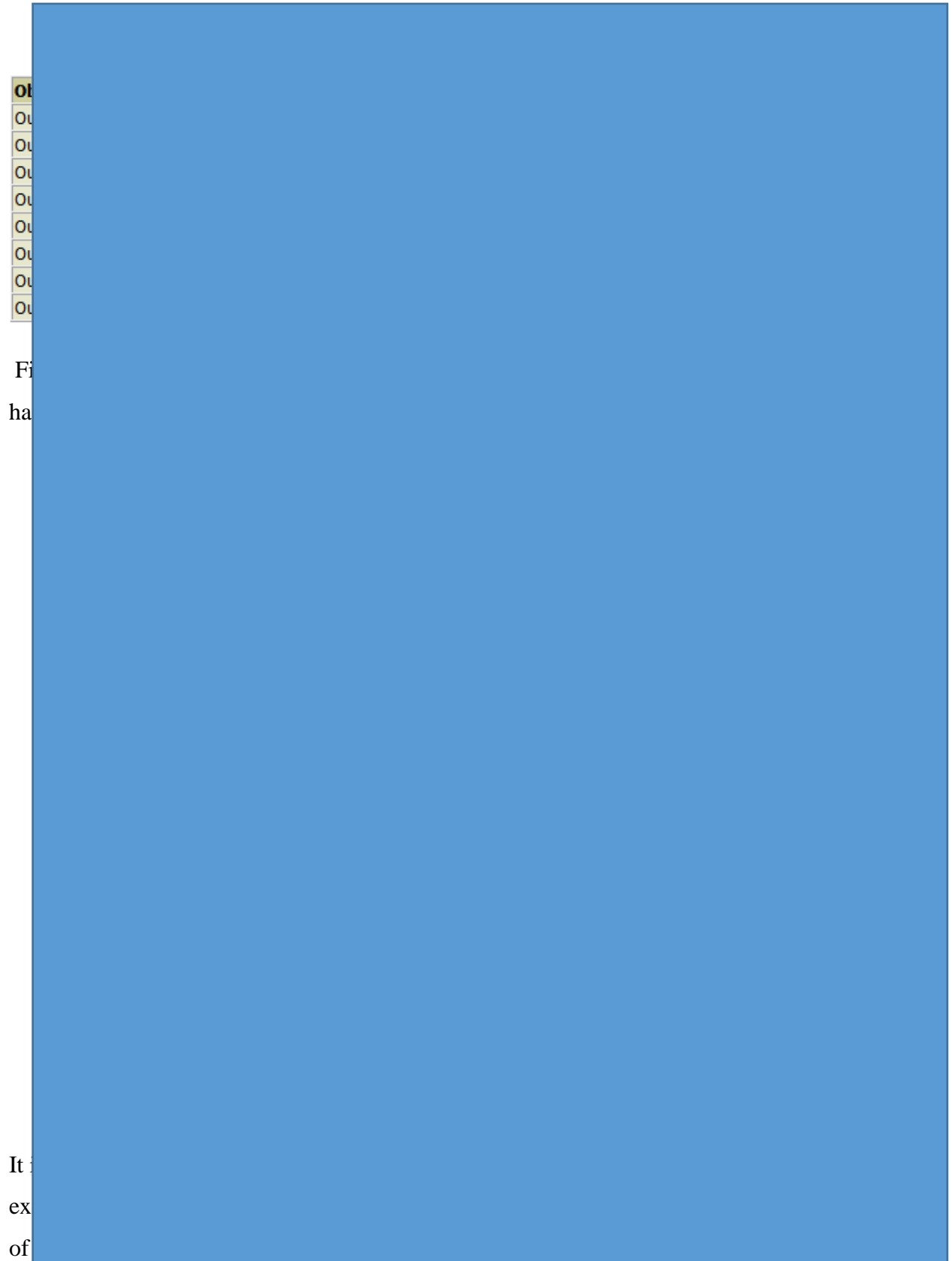


Table 44. shows the cumulated statistics for the components processed during the examined period. In detailed, the column throughput displays that only for the components 2 it is not reached the planned number of units in the available time (255 instead of 281).



A more detailed comparison between alternatives with values of percentage of working for each machine will be [REDACTED]

[REDACTED]

[REDACTED]

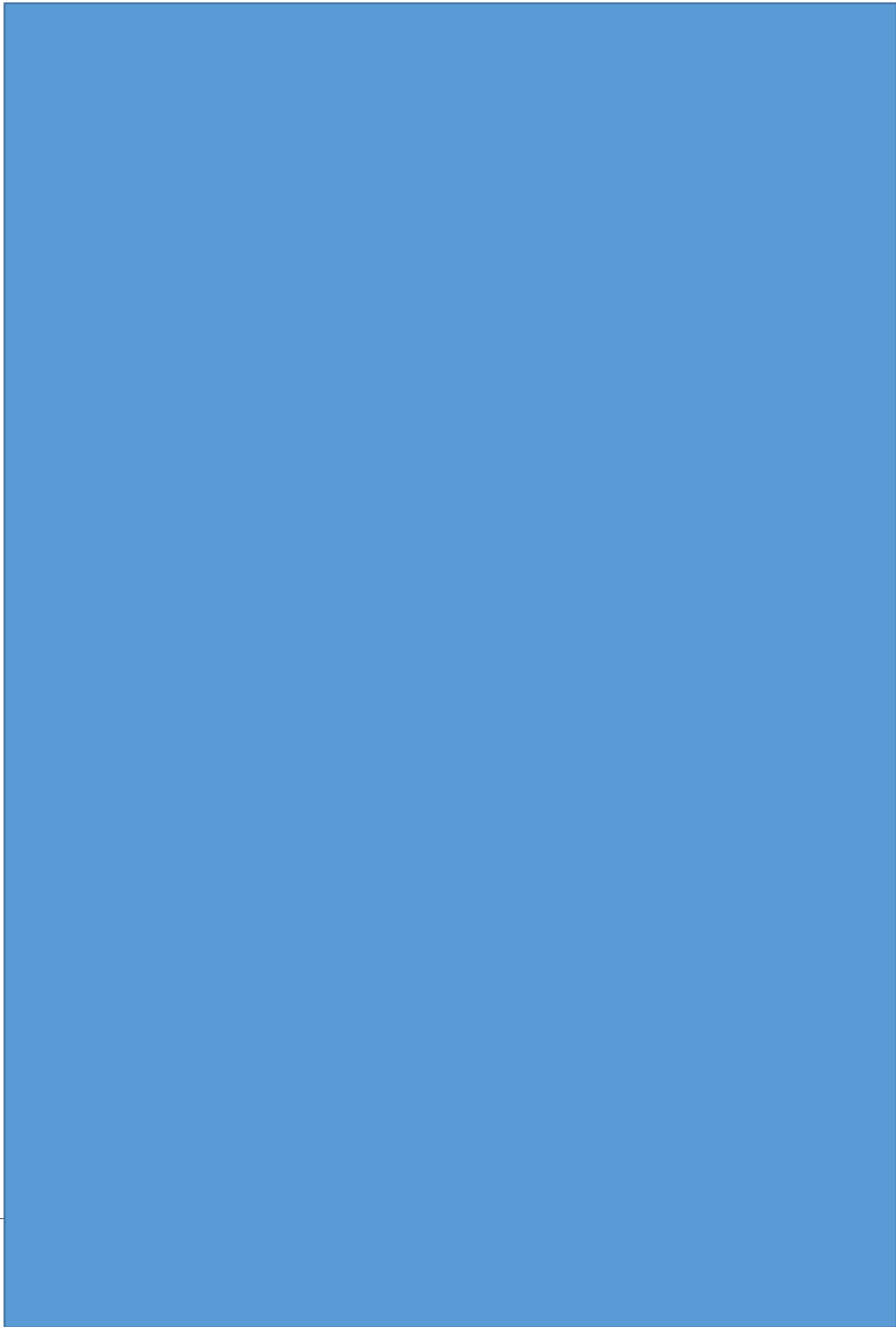


Table 45. shows the percentage of working time for each machine. It has been highlighted in grey the best value between different alternatives.

[Redacted text]

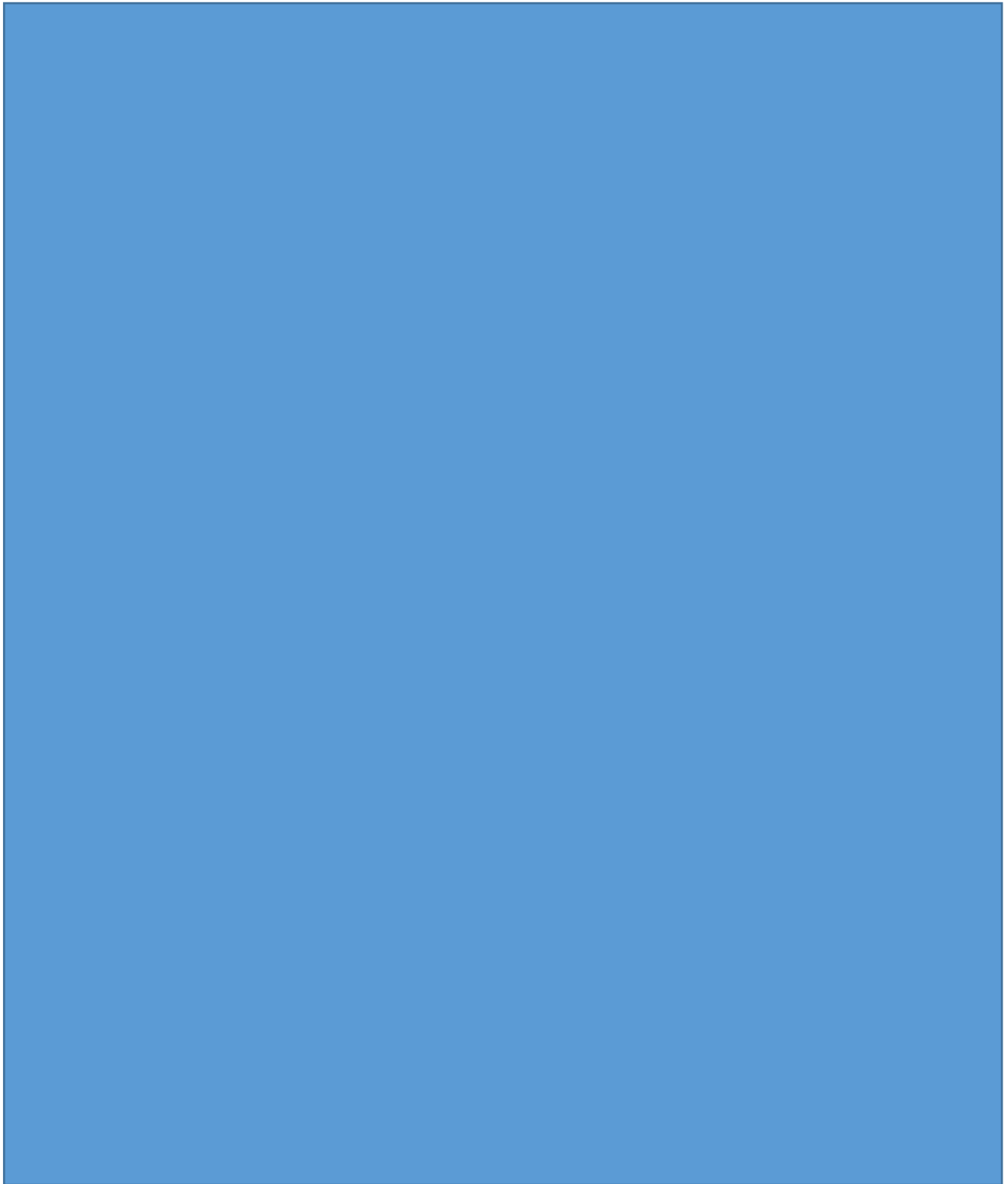
	[Redacted]	[Redacted]	[Redacted]
[Redacted]	[Redacted]	[Redacted]	[Redacted]
[Redacted]	[Redacted]	[Redacted]	[Redacted]
[Redacted]	[Redacted]	[Redacted]	[Redacted]
[Redacted]	[Redacted]	[Redacted]	[Redacted]
[Redacted]	[Redacted]	[Redacted]	[Redacted]
[Redacted]	[Redacted]	[Redacted]	[Redacted]
[Redacted]	[Redacted]	[Redacted]	[Redacted]
[Redacted]	[Redacted]	[Redacted]	[Redacted]

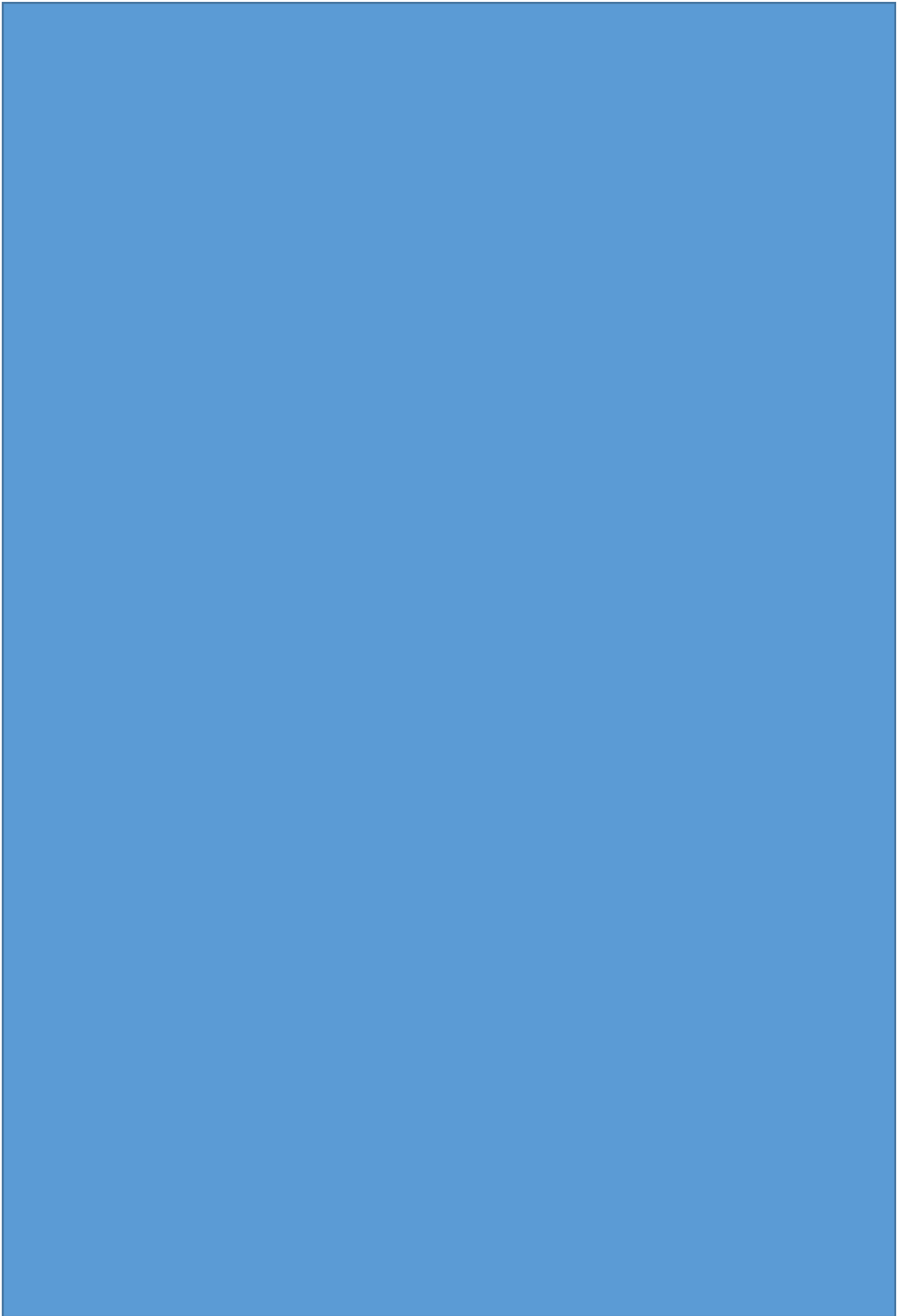
[Redacted text block]

[REDACTED]

[REDACTED] [REDACTED]	[REDACTED]	[REDACTED] [REDACTED]	[REDACTED] [REDACTED]	[REDACTED] [REDACTED] [REDACTED]
[REDACTED]	[REDACTED] [REDACTED]	[REDACTED]	[REDACTED] [REDACTED]	[REDACTED]
[REDACTED]	[REDACTED] [REDACTED] [REDACTED]	[REDACTED]	[REDACTED] [REDACTED]	[REDACTED]
[REDACTED]	[REDACTED] [REDACTED]	[REDACTED]	[REDACTED] [REDACTED]	[REDACTED]
[REDACTED]	[REDACTED]	[REDACTED]	[REDACTED] [REDACTED]	[REDACTED]

[REDACTED]
[REDACTED]
[REDACTED]
[REDACTED]





[Redacted text block]

[Redacted text block]

[Redacted]	[Redacted]	[Redacted]
[Redacted]	[Redacted]	[Redacted]
[Redacted]	[Redacted]	[Redacted]
[Redacted]	[Redacted]	[Redacted]
[Redacted]	[Redacted]	[Redacted]
[Redacted]	[Redacted]	[Redacted]
[Redacted]	[Redacted]	[Redacted]
[Redacted]	[Redacted]	[Redacted]
[Redacted]	[Redacted]	[Redacted]

[Redacted text block]

6. CONCLUSION

Nowadays cable factories have to face multiple challenges related to the uncertainty of the demand, the high level of competition and the requests of high-quality customized products. The principal indicators of performance that need to be improved in order to survive and compete in the market are the lead times, the customer satisfaction and the utilization of machinery. Moreover, the cable manufacturing is a complex system composed by different processes that require to be analyzed and controlled in order to improve the efficiency of the whole system. Simulation is a sophisticated tool that can help factories to investigate production problems and to introduce optimization by studying the results of simulation runs according to different scenarios. Building a model that represents approximately the reality allows to make experiments on it saving time and money and without disturbing the real system. For this reason, factories should take into account the possibility of integrating simulation tool with their data base management systems and the utilization of simulation software in their routines.

In this work it has been used the software package Siemens Tecnomatix 11 PlantSimulation to analyze the production system of ELKA factory considering four representative products that count for the main percentage of the total annual customer demand. It has been built the simulation model of the metal department where conductors have been created before the application of the insulation and it has been investigated the different work load of the machines involved changing number of series produced. The purpose is to evaluate the flexibility of the system when the number of orders increase or after the decision to introduce stock replenishment orders. It has been evaluated four different alternatives showing the different results of simulation in statistical diagrams.

The first situation experimented is the actual situation that consists just of *Make-To-Order* products with a certain amount of orders per year. The second alternative has been obtained by increasing the number of orders of the 15 % (and the number of batches as well, under the hypothesis that one batch correspond to one order), while the third alternative has been obtained by increasing the number of order of the 10 % compared with the actual situation. In general, the utilization of the machines increases for these two solutions, but it is not possible to produce all the planned numbers of components that compose a product in the annual available time. Therefore, it is evaluated another solution that can improve both utilization of machinery and reduction of lead times (and it affects customer satisfaction, too), which is the alternative 4. This solution considers the increase of production orders for some components (*Form Postponement* approach), in order to improve the occupancy of the machines in accordance with time constraint.

Choosing the fourth alternative, there has been an increase of utilization [REDACTED]

A further work could include in the simulation model means of transports, in particular forklifts, whose number here has been calculated manually taking into account the layout distances and the flow of materials between different machines. It obviously leads to a more realistic model able to calculate the transportation times and costs.

Moreover, it could be useful to focus on integration among various software present in ELKA. In fact, simulation software can be used more efficaciously in factories if supported by a powerful data management system such as Oracle able to store the data of the simulation model.

It is also suitable to extend the simulation to all the high-variety of products offered by ELKA factory, even if it means a large effort in terms of time required to collect data and to build a more complex simulation model.

8. LITERATURE

- [1] John Cadick, Cables and wiring, AVO International Training Institute, 1999.
- [2] Rob Zachariason, Electrical materials, Cengage Learning, 2011.
- [3] <http://electrical-engineering-portal.com/> Last access: 2015-10-20
- [4] <http://www.slideshare.net/> Last access: 2015-10-15
- [5] M.A. Laughton, M. G. Say, Electrical Engineer's Reference Book, Elsevier, 2002.
- [6] <https://www.integer-research.com/> Last access: 2015-10-03
- [7] <http://www.economist.com/node/1291432> Last access: 2015-10-04
- [8] <http://www.prnewswire.com/news-releases/> Last access 2015-10-7
- [9] <http://www.prysmiangroup.com/en/index.html> Last access 2015-11-06
- [10] <http://elka.hr/> Last access 2015-10-10
- [11] Ganesh D. Bhatt, Varun Grover, Types of Information Technology Capabilities and Their Role in Competitive Advantage: An Empirical Study, Journal of Management Information Systems, 22:2, 253-277, 2005.
- [12] <http://www.cimteq.com/> Last access 2015-10-26
- [13] Alexis Leon, Enterprise Resource Planning, McGraw-Hill Education, 2008.
- [14] Henning Kagermann, Gerhard Kelle, MySAP.com Industry Solutions: New Strategies for Success with SAP's Industry Business Units, Pearson Education, 2001.
- [15] <https://www.sikora.net/> Last access: 2015-10-18
- [16] http://www.ateneonline.it/chase2e/studenti/tn/6184-7_tn05.pdf
- [17] William A. Thue, Electrical power cable engineering: second edition, CRC Press, 2003.
- [18] Anselmi Immonen, Antti Saaksvuori, Product Lifecycle Management, Springer Science & Business Media, 2008.

- [19] Ke-Sheng Wang, Intelligent and integrated RFID (II-RFID) system for improving traceability in manufacturing, 2014.
- [20] <http://www.rmmagazine.com/2010/06/01/the-volatility-of-raw-materials-markets/> Last access: 2015-10-26
- [21] Naim Kheir, Systems Modeling and Computer Simulation, Second Edition, 1996.
- [22] http://www.researchgate.net/publication/228359022_Use_of_simulation_in_manufacturing_and_logistics_systems_planning Last access: 2015-12-15
- [23] http://www.sztaki.hu/~kadar/pdf_files/Kadar_Pfeiffer_Monostori_ISMS_2004.pdf Last access: 2015-12-18
- [24] <http://www.sciencedirect.com/science/article/pii/S2212827114010634> Last access: 2015-12-21
- [25] Christopher A. Chung, Simulation modeling handbook a practical approach, 2003.
- [26] Steffen Bangsow, Tecnomatix Plant Simulation: Modeling and Programming by Means of Examples, 2015.
- [27] <http://citeseerx.ist.psu.edu/viewdoc/download?doi=10.1.1.300.3013&rep=rep1&type=pdf> Last access: 2016-01-13
- [28] <http://www.wright.edu/~george.polak/lots.pdf> Last access: 2016-01-09
- [29] <http://www.technicaljournalonline.com/ijeat/VOL%20III/IJAET%20VOL%20III%20ISSUE%20I%20JANUARY%20MARCH%202012/13%20IJAET%20Vol%20III%20Issue%20I%202012.pdf> Last access: 2016-01-14
- [30] <http://publications.lib.chalmers.se/records/fulltext/159322.pdf> Last access: 2016-01-16
- [31] <http://www.plm.automation.siemens.com/> Last access: 2016-02-08
- [32] <http://www.slideshare.net/christian.reinboth/lecture-notes-cop-complete> Last access: 2016-01-18
- [33] <http://www.reactivescheduling.com/wp-content/uploads/2015/02/Lean-Cables-A-step-towards-Competitive-Sustainable-and-Profitable-Processes.pdf> Last access: 2016-01-18
- [34] <https://it.wikipedia.org/wiki/Wikipedia> Last access: 2016-01-27
- [35] <http://konradkierys.com/pieprz/media/doc/Decoupling.pdf> Last access: 2016-01-20
- [36] http://essay.utwente.nl/66846/1/Bijen_MA_MB.pdf Last access 2016-01-21