

A procedure for improving the energy efficiency and environmental performance of short sea and inland waterway vessels

Perčić, Maja

Doctoral thesis / Disertacija

2022

Degree Grantor / Ustanova koja je dodijelila akademski / stručni stupanj: **University of Zagreb, Faculty of Mechanical Engineering and Naval Architecture / Sveučilište u Zagrebu, Fakultet strojarstva i brodogradnje**

Permanent link / Trajna poveznica: <https://urn.nsk.hr/urn:nbn:hr:235:542084>

Rights / Prava: [In copyright](#) / [Zaštićeno autorskim pravom.](#)

Download date / Datum preuzimanja: **2024-07-17**

Repository / Repozitorij:

[Repository of Faculty of Mechanical Engineering and Naval Architecture University of Zagreb](#)





University of Zagreb

Faculty of Mechanical Engineering and Naval Architecture

Maja Perčić

**A PROCEDURE FOR IMPROVING
THE ENERGY EFFICIENCY AND
ENVIRONMENTAL PERFORMANCE OF
SHORT SEA AND INLAND
WATERWAY VESSELS**

DOCTORAL DISSERTATION

Zagreb, 2022



University of Zagreb

Faculty of Mechanical Engineering and Naval Architecture

Maja Perčić

**A PROCEDURE FOR IMPROVING THE
ENERGY EFFICIENCY AND
ENVIRONMENTAL PERFORMANCE OF
SHORT SEA AND INLAND
WATERWAY VESSELS**

DOCTORAL DISSERTATION

Supervisor:

Associate Professor Nikola Vladimir, PhD

Zagreb, 2022



Sveučilište u Zagrebu

Fakultet strojarstva i brodogradnje

Maja Perčić

**POSTUPAK POBOLJŠANJA
ENERGETSKE UČINKOVITOSTI I
EKOLOŠKE PRIHVATLJIVOSTI
BRODOVA ZA PRIOBALNU I
UNUTARNJU PLOVIDBU**

DOKTORSKI RAD

Mentor:

izv. prof. dr. sc. Nikola Vladimir

Zagreb, 2022.

Acknowledgements

I would like to express my sincere gratitude to my supervisor, Associate Professor Nikola Vladimir, Ph.D., for his guidance and support during my studies. His advices and suggestions pushed me to become a better researcher.

I would like to thank my colleagues on the 10th floor, especially Ivana and Marija, without whom the days at the Faculty would not be as funny as they are. Thank you for your support and advices.

Finally, I would like to express my gratitude to my family, friends, and my fiancé Bernard for their support, help and love. I dedicate my work to them.

Summary

The emissions released due to the combustion of fossil fuels in marine engines negatively affect the environment and human health. This impact of shipping is more pronounced when the ships operate near populated areas and spend much time in ports, and in that way, directly impair the air quality of the local population. These ships are usually engaged in the short-sea shipping and inland navigation sector. In this doctoral dissertation, the focus is put on the Croatian short-sea shipping and inland navigation fleets, which mainly include outdated ships with low energy efficiency. Their design methods either did not include energy efficiency criteria or included them according to relatively old and simple models and criteria. These fleets need to adapt to current environmental trends, whereby it is necessary to choose a set of appropriate technical and operational measures that would be cost-effective for the current fleet situation and market circumstances. In this research, the investigation of applicability and availability of alternative power systems onboard considered ships is performed. By comparing the different alternatives based on their environmental impact and economic performance, obtained by performing Life-Cycle Assessments and Life-Cycle Cost Assessments, the set of appropriate alternatives that satisfy both criteria is identified. To investigate the energy efficiency of the ships powered by alternative power systems, the mathematical model for simultaneous assessment of ship energy efficiency and environmental friendliness is formulated, which can be applied not only to diesel-powered ships but to a range of alternative powering options. The final step in the research was the development of the design procedure for the power systems of short-sea shipping and inland waterway vessels, with higher energy efficiency and lower overall costs than the existing solutions. The developed procedure is tested for the ships engaged in the short-sea shipping fleet, and in most cases, the results indicated full electrification with only a battery as the optimal solution for the replacement of the diesel power system configuration of considered ships. Although the Croatian short sea-sea and inland waterway fleets are taken as test cases, the developed methodology is generally applicable if a set of input data on fleet technical and operational properties and corresponding fuel cycles is known.

Keywords:

Short-sea shipping sector, Inland navigation sector, Alternative ship power system, Electrification, Energy efficiency, Environmental friendliness.

Prošireni sažetak

Ispušni plinovi nastali izgaranjem fosilnih goriva u brodskim motorima smatraju se glavnim uzrokom onečišćenja zraka u pomorskom okolišu. U literaturi koja se bavi ovom problematikom razlikujemo štetne emisije dušikovih oksida (NO_x), sumporovih oksida (SO_x), ugljikovog monoksida (CO), lebdećih čestica te emisije stakleničkih plinova (ugljikov dioksid (CO₂), metan (CH₄), didušikov oksid (N₂O)) [1]. Njihova prisutnost u atmosferi negativno utječe na okoliš i ljudsko zdravlje [2], što je posebice izraženo kod brodova priobalne i unutarnje plovidbe, koji provode razmjerno puno vremena u blizini naselja [3], [4]. Zahtjevi vezani uz zaštitu okoliša prisilili su pomorski sektor na povećanje energetske učinkovitosti, uz pretpostavku da navedeno povećanje vodi k smanjenju utjecaja pomorskog prometa na okoliš. Odbor za zaštitu pomorskog okoliša (eng. *Marine Environment Protection Committee*, MEPC) pri Međunarodnoj pomorskoj organizaciji (eng. *International Maritime Organization*, IMO) donio je rezoluciju u kojoj je dodano poglavlje o energetske učinkovitosti brodova [5], a prema kojoj brodovi koji sudjeluju u međunarodnoj plovidbi trebaju imati Međunarodni certifikat energetske učinkovitosti. Za njegovo izdavanje brodovi trebaju udovoljiti zahtjevima Projektnog indeksa energetske učinkovitosti (eng. *Energy Efficiency Design Index*, EEDI) i imati Brodski plan upravljanja energetske učinkovitošću (eng. *Ship Energy Efficiency Management Plan*, SEEMP). EEDI predstavlja tehničku mjeru energetske učinkovitosti i izražava se kao omjer emisije CO₂ i gospodarskog učinka broda [6]. Pri tome valja naglasiti da je riječ o projektnoj veličini koja se analizira za jednu radnu točku, budući da je vezana za projektnu nosivost i brzinu broda, koje se u njegovoj eksploataciji pojavljuju vrlo rijetko. Projektni indeks energetske učinkovitosti određuje se za brodove veće od 400 GT u međunarodnoj plovidbi, dok za brodove priobalne plovidbe (angažirane u teritorijalnim vodama jedne države) i brodove unutarnje plovidbe trenutno ne postoji zakonska regulativa kojom bi se analizirala energetska učinkovitost. Spomenuti model nije izravno primjenjiv na brodove koji bi podrazumijevali korištenje alternativnih izvora energije ili za potpuno električne brodove.

Povećanje energetske učinkovitosti brodova te smanjenje njihovih emisija, posebice CO₂ koji je glavni staklenički plin čija povećana koncentracija u atmosferi doprinosi globalnom zatopljenju, može se postići primjenom određenih tehničkih i operativnih mjera [7]. Studije ukazuju da je najbolja mjera zamjena konvencionalnog brodskog energetskeg sustava s alternativnim. Smanjenje emisija je važno i za hrvatske flote priobalne i unutarnje plovidbe, koje čine relativno stari brodovi niske energetske učinkovitosti. Navedene flote trebaju se

prilagoditi suvremenim ekološkim trendovima, pri čemu je potrebno odabrati skup odgovarajućih mjera koje bi za odgovarajuće stanje flote i tržišne okolnosti bili isplative.

U ovom radu razvijen je projektni postupak za brodske energetske sustave visoke razine energetske učinkovitosti, uzimajući u obzir specifične eksploatacijske zahtjeve priobalne i unutarnje plovidbe u cjeloživotnom okruženju i tržišne zakonitosti u Republici Hrvatskoj. Prvi korak istraživanja obuhvatio je analizu tehničkih značajki i načina korištenja brodova priobalne i unutarnje plovidbe (s naglaskom na brodske energetske sustave). U drugom koraku provedena je analiza dostupnosti alternativnih goriva (prirodni plin, električna energija, metanol, amonijak, vodik itd.) na području Republike Hrvatske. Njihova primjena na odabranim brodovima razmatranih flota istražila se procjenom životnog ciklusa (eng. *Life-Cycle Assessment*, LCA) broskog energetskeg sustava na okoliš te procjenom troškova životnog ciklusa (eng. *Life Cycle Cost Assessment*, LCCA). LCA ocjenjuje utjecaj broskog energetskeg sustava na okoliš kroz količine emisija koje se ispuštaju tijekom cijelog životnog vijeka energetske konfiguracije, odnosno od izrade dijelova energetske konfiguracije (baterija, motor, gorivni članak i sl.), proizvodnje izvora energije (gorivo, struja i sl.) do njegove primjene na brodu. Utvrđivanje održivosti i isplativosti alternativnih brodskih energetskeg sustava postiže se provođenjem LCCA koja uzima u obzir troškove ulaganja, goriva, održavanja i zamjene opreme tijekom životnog vijeka proizvoda. Usporedba LCA i LCCA rezultata različitih goriva dovela je do identifikacije seta alternativnih tehnologija koje su primjenjive na odabranim brodovima priobalne i unutarnje flote Republike Hrvatske, a koji imaju manje cjeloživotne troškove i emisije od postojećih konvencionalnih rješenja. Analiza je posebno istaknula potpunu elektrifikaciju samo s baterijom, kao i primjenu metanola, kao izvedive alternative koje zadovoljavaju ekološke i ekonomske kriterije.

Treći korak u ovom istraživanju predstavlja definiranje indeksa energetske učinkovitosti koji istodobno u obzir uzima energetske učinkovitost broda i ekološku prihvatljivost, a može se primijeniti ne samo na brodove s pogonjene dizelskim motorom već i na niz alternativnih opcija napajanja. Uključivanje LCA i LCCA u definiciju novog indeksa energetske učinkovitosti predstavlja važan iskorak u poboljšanju postojećeg modela. Naposljetku, razvijen je projektni postupak kojim je moguće odabrati prikladne konfiguracije brodskih energetskeg sustava brodova priobalne i unutarnje plovidbe s alternativnim izvorima energije, koji imaju povoljnije vrijednosti indeksa energetske učinkovitosti u odnosu na postojeća rješenja. Istraživanja provedena u ovom doktorskom radu vezana su za Uspostavni istraživački projekt

„Zeleni modularni putnički brod za Mediteran“ (UIP-2017-05-1253), financiran od Hrvatske zaklade za znanost, a zaposlenje doktorandice financirano je također od Hrvatske zaklade za znanost iz „Projekta razvoja karijera mladih istraživača – izobrazba novih doktora znanosti“ u okviru natječaja DOK-01-2018.

a) Ciljevi i hipoteze

Glavni cilj ovog istraživanja je razviti projektni postupak za brodske energetske sustave visoke razine energetske učinkovitosti, uzimajući u obzir specifične eksploatacijske zahtjeve priobalne i unutarnje plovidbe i tržišne zakonitosti u Republici Hrvatskoj. Projektni postupak podrazumijeva i vezan je uz ostvarenje drugih ciljeva rada, odnosno definiranje projektnog indeksa energetske učinkovitosti za brodove priobalne i unutarnje plovidbe koji je primjenjiv za brodske energetske sustave s alternativnim izvorima energije, te ujedno i istraživanje dostupnosti alternativnih energetskih rješenja na području Republike Hrvatske i njihovu primjenjivost u hrvatskoj floti priobalne i unutarnje plovidbe.

Prva hipoteza na kojoj se temelji ovo istraživanje je da je moguće definirati projektni indeks energetske učinkovitosti za brodove priobalne i unutarnje plovidbe, koji uključuje više radnih točaka (različite brzine plovidbe, a posljedično i radne režime kojima je podvrgnut brodski energetski sustav) i primjenjiv je za energetske sustave koji uključuju alternativne izvore energije. Druga hipoteza je da moguće je razviti projektni postupak za energetske sustava brodova priobalne i unutarnje plovidbe, koji će imati veću energetske učinkovitost i manje ukupne troškove od postojećih rješenja.

b) Znanstveni doprinosi

Znanstveni doprinosi ovog rada su u području tehničkih znanosti, znanstvenom polju brodogradnje, a temelj im predstavlja formulacija indeksa energetske učinkovitosti i ekološke prihvatljivosti brodova za priobalnu i unutarnju plovidbu u Republici Hrvatskoj s proizvoljnim udjelom alternativnih izvora energije. Dakle, definiran matematički model istodobno procjenjuje energetske učinkovitost broda i ekološku prihvatljivost, a može se primijeniti ne samo na brodove pogonjene dizelskim motorom već i na niz alternativnih opcija napajanja. Predstavljeni model je prvi znanstveni doprinos ovog rada i nastao je kao rezultat proširenja modela iz dostupne literature koji podrazumijevaju isključivo pogonske sustave temeljene na dizelskim motorima kao prvopokretačima. Brodovi razmatranih flota uglavnom su zastarjeli,

pogonjeni dizelskim motorima razmjerno niske energetske učinkovitosti . Zamjena brodova novima ili zamjena njihovog energetskog sustava alternativnim otvara mogućnost za implementaciju inovativnih i zelenih tehnologija koje će zadovoljiti ekološke propise i smanjiti izravan utjecaj na lokalno stanovništvo. Mogućnost uvođenja različitih politika penalizacije emisija koje nastaju izgaranjem fosilnog goriva u brodskim motorima djeluje kao poticaj brodovlasnicima i prijevoznicima na primjenu alternativnih brodskih energetskih sustava čije korištenje na brodu rezultira manjim emisijama u usporedbi s postojećim energetskim sustavom ili ih u eliminira. Kako bi ispitao njihov utjecaj na okoliš, emisije razmatranih energetskih sustava treba istražiti s cjeloživotnog stajališta pomoću LCA, uzimajući u obzir emisije ciklusa goriva (od vađenja sirovine, njenog prijevoza do proizvodnog postrojenja, do proizvodnje samog goriva te njegove distribucija do crpke), upotreba goriva na brodu te proizvodnja glavne opreme sustava. Uz ispitivanje utjecaja na okoliš, važno je istražiti i isplativost brodskih energetskih sustava pomoću LCCA, uzimajući u obzir troškove investicije, održavanje, goriva i zamjene opreme tijekom eksploatacije broda. Provođenjem LCA i LCCA različitih brodskih energetskih sustava analizirala se njihova primjena u hrvatskoj floti priobalne i unutarnje plovidbe. Identificiran je skup alternativnih energetskih rješenja koja imaju manje cjeloživotne emisije i cjeloživotne troškove od postojećeg brodskog energetskog sustava, što je ujedno i drugi doprinos ovog doktorskog rada.

Treći doprinos ovog rada je projektni postupak za energetske sustave visoke razine energetske učinkovitosti za brodove koji relativno često mijenjaju operativne režime, kakvi su dominantno zastupljeni u hrvatskoj priobalnoj i unutarnjoj plovidbi. Provođenjem LCA i LCCA različitih energetskih sustava te usporedba njihovih vrijednosti formuliranog indeksa, projektni postupak identificira optimalno rješenje koje ima višu energetske učinkovitost, manje emisije i manje troškove od postojećih rješenja. Iako je rad usmjeren na brodove priobalne i unutarnje flote Republike Hrvatske, razvijeni projektni postupak, formulirani indeks energetske učinkovitosti primjenjiv je i za alternativne elektroenergetske sustave, kao i modeli ekonomske analize i analize utjecaja na okoliš alternativnih rješenja općenito su primjenjivi na sektore priobalne i unutarnje plovidbe drugih zemalja ako je skup specifičnih ulaznih podataka dostupan.

Ključne riječi:

Sektor priobalne plovidbe, sektor unutarnje plovidbe, alternativni brodski energetski sustav, elektrifikacija, energetska učinkovitost, ekološka prihvatljivost.

Nomenclature

Abbreviations

A	Ammonia
B-A	Blue ammonia
BAT	Battery power system
BD	Biodiesel-diesel blend
B-H	Blue hydrogen
CF	Carbon Footprint
CII	Carbon Intensity Indicator
CNG	Compressed Natural Gas
CP	Current Policies
D	Diesel
DE	Diesel engine power system
DME	Dimethyl ether
E	Electricity
ECA	Emission Control Area
EEDI	Energy Efficiency Design Index
EEXI	Energy Efficiency Existing Ship Index
GHG	Greenhouse Gas
Gn-A	Green ammonia
Gn-H	Green hydrogen
Gy-A	Grey ammonia
Gy-H	Grey hydrogen
H	Hydrogen
HFO	Heavy Fuel Oil
HPS	Hybrid Power System
I4E	Energy Efficiency and Environmental Eligibility Index

ICE	Internal Combustion Engine
IEE	International Energy Efficiency
IMO	International Maritime Organization
IPS	Integrated Power System
KPI	Key Performance Indicator
LCA	Life-Cycle Assessment
LCCA	Life-Cycle Cost Assessment
Li-ion	Lithium-ion
LNG	Liquefied Natural Gas
LPG	Liquefied Petroleum Gas
M	Methanol
MARPOL	International Convention for the Prevention of Pollution from Ships
MBM	Market-Based Measure
MDO	Marine Diesel Oil
MGO	Marine Gas Oil
NT	Non-taxation
PEMFC	Proton Exchange Membrane Fuel Cell
PM	Particulate Matter
PTW	Pump-to-Wake
PV	Photovoltaic
PV-BAT	Photovoltaic system-battery power system
RES	Renewable Energy Sources
RH	Renewable Hydrogen
SD	Sustainable Development
SEEMP	Ship Energy Efficiency Management Plan
SOFC	Solid Oxide Fuel Cell
SP	Stated Policies
WTP	Well-to-Pump

Variables

<i>AFP</i>	Aerosol formation potential (kg PM 2.5-eq)
<i>AP</i>	Acidification potential (kg SO ₂ -eq)
<i>B</i>	Breadth (m)
<i>BS</i>	Benefit for the society (€)
<i>CA</i>	Carbon allowance (€/kg CO ₂)
<i>DWT</i>	Deadweight (t)
<i>E</i>	Emission (kg)
<i>EEI</i>	Energy efficiency and emission index (kg emissions-eq/€)
<i>EP</i>	Eutrophication potential (kg PO ₄ -eq)
<i>FED</i>	Fossil energy demand (%)
<i>GWP</i>	Global warming potential (kg CO ₂ -eq)
<i>l</i>	Route length (nm)
<i>L</i>	Ship length overall (m)
<i>L_{PP}</i>	Length between perpendiculars (m)
<i>LT</i>	Lifetime (year)
<i>N</i>	Number of round trips (-)
<i>NPV</i>	Net present value (€)
<i>P</i>	Power (kW)
<i>t</i>	Route duration (h)
<i>T</i>	Draught (m)
<i>TE</i>	Tailpipe emissions (kg)
<i>v</i>	Speed (kn)

Subscripts

A	Annual
AE	Auxiliary engine

d	Design
ME	Main engine

Greek Symbols

α	Weighting factor for <i>GWP</i>
β	Weighting factor for <i>AP</i>
γ	Weighting factor for <i>EP</i>

List of tables

Table 1. The Croatian ro-ro passenger ships.....	20
Table 2. Reduction of tailpipe emissions for each alternative solution [36].....	22
Table 3. The Croatian inland waterway vessels and their exploitation characteristics [100] ..	23
Table 4. Technical and operational data of the considered ro-ro passenger ships [102]	27
Table 5. Technical and operational data of the considered inland waterway ships [104].....	28
Table 6. The ship power system configurations with different fuels [105]	31
Table 7. Results of the replacement of the diesel-power system with the considered fuel cell systems [103]	44

List of figures

Figure 1. Decarbonization measures for the shipping sector [36].....	5
Figure 2. Alternative marine fuels uptake from 2021 (reproduced from [42] with permission of DNV, 2022).....	6
Figure 3. Initial IMO strategy of GHG emissions (reproduced from [90] with permission of DNV, 2022)	10
Figure 4. The Croatian CO ₂ emissions in 2019 [107], [109]	17
Figure 5. The Croatian routes of short-sea shipping [114]	19
Figure 6. CO ₂ Index of the selected ferry lines [36]	21
Figure 7. Croatian inland waterway network [100]	23
Figure 8. Considered ro-ro passenger ships [102].....	26
Figure 9. Considered inland waterway ships [104].....	27
Figure 10. Implementation of the carbon allowance in different scenarios [104]	30
Figure 11. LCA and LCCA comparison of different alternative fuels on board ro-ro passenger ships [102]	32
Figure 12. LCA and LCCA comparison of different alternative fuels implemented on inland waterway vessels [104]	33
Figure 13. Influence of energy mixes on life-cycle CO ₂ -eq emissions [102].....	35
Figure 14. LCA of different power systems implemented on ro-ro passenger ships [101] ...	36
Figure 15. LCCA of different power systems implemented on ro-ro passenger ships [101] .	37
Figure 16. LCA of different power systems implemented on inland vessels [100].....	38
Figure 17. LCCA of different power systems implemented on inland vessels [100].....	38
Figure 18. Environmental and economic KPIs [103].....	40
Figure 19. Life-cycle CO ₂ -eq emissions of the considered fuel cell systems [103]	41
Figure 20. LCCA results of the considered fuel cell systems [103]	42
Figure 21. A comparison of the KPIs of different ship power systems [103].....	43
Figure 22. The ship design procedure based on the modular concept [105].....	46
Figure 23. Identification of appropriate power system within the modular approach in the design of small passenger ships for the Mediterranean [105]	47
Figure 24. The method for the calculation of EEI [106]	49
Figure 25. Calculated EEI for ships with different power systems [106]	50

Figure 26. Impact of speed reduction on annual CO₂-eq emissions of ships with different power systems [106]..... 51

Figure 27. Impact of speed reduction on annual economic profit of ships with different power systems [106]..... 52

Figure 28. EEIs comparison of diesel-powered ships and electricity-powered ships operating at different speeds [106] 53

Figure 29. Design procedure for power systems of short-sea and inland waterway vessels, with higher energy efficiency levels and lower costs than the existing solutions..... 54

Contents

Acknowledgements	I
Summary	II
Prošireni sažetak.....	III
Nomenclature	VII
List of tables	XI
List of figures	XII
1. Introduction.....	1
1.1. Research background.....	1
1.1.1. Regulatory framework on energy efficiency and environmental friendliness in the shipping sector.....	1
1.1.2. Emission reduction measures	4
1.2. Motivation	12
1.3. Objectives and hypothesis of the research.....	13
1.4. Scientific contributions of the research	13
1.5. Applied methods.....	14
2. Selected results and discussion	15
2.1. Analyses of the Croatian short sea shipping and inland navigation fleets	16
2.1.1. Short-sea shipping fleet	19
2.1.2. Inland navigation fleet.....	23
2.2. Analysis of alternative power solutions applicable onboard the Croatian ships	25
2.2.1. Application of alternative marine fuels and RESs	29
2.2.2. Application of fuel cells in the short-sea shipping sector	40
2.2.3. Applicability of developed mathematical models for environmental and economic assessments.....	46
2.3. Formulation of energy efficiency index applicable to ship power systems with alternative energy sources	48
2.4. Design procedure of high energy efficiency power systems for ships.....	54
3. Conclusions and future work	57
3.1. Conclusions of the doctoral disseration.....	57

3.2. Guidelines for future work	58
4. Bibliography	60
5. Curriculum vitae	73
6. List of publications	74
7. Summary of articles	78
ARTICLES	87

1. Introduction

1.1. Research background

1.1.1. Regulatory framework on energy efficiency and environmental friendliness in the shipping sector

Ship energy efficiency and the impact of maritime transportation on the maritime environment have become very important issues for all parties involved in the shipping sector, i.e. shipbuilders, ship-owners, public authorities, policymakers, etc. The exhaust gas released by the combustion of fossil fuel in marine engines can be considered one of the major causes of marine environment pollution, where among different emissions, sulphur oxides (SO_x), nitrogen oxides (NO_x), Particulate Matter (PM), and Greenhouse Gases (GHGs) are highlighted as the most significant [1]. The emissions of PM, SO_x, and NO_x have a negative impact on humanity by causing respiratory diseases and other health issues, while NO_x and SO_x emissions can negatively affect both terrestrial and aquatic ecosystems through eutrophication and acidification [8]. The latter emissions fall from the atmosphere to the ground in the form of acid rain/snow/mist and affect waters and soil, which consequently affect the level of nutrients in the body of water by causing eutrophication [9].

NO_x, SO_x and PM emissions are local pollutants that affect the surrounding population and environment nearby the areas ships are operating, while the raising concentration of GHGs represents a problem on the global scale [8]. The GHG emissions in the atmosphere form a thick layer that blocks infrared radiation from escaping into outer space, which is known as the greenhouse effect. As a result, the earth's surface is warming up (global warming), which causes various types of climate change. GHGs are a mixture of different gases where carbon dioxide (CO₂) is the major one, while methane (CH₄) and nitrous oxide (N₂O) are present in a lower concentration, and they each make a different contribution to global warming [10]. In order to control the sources of anthropogenic GHG emissions, a set of regulations has been prescribed, such as the Kyoto Protocol, an international agreement for the reduction of GHG

emissions which was adopted in 1997 with the aim of preventing global warming [11]. The climate agreement signed in 2015 in Paris and set into force in 2016, i.e. Paris Agreement, had the goal of holding any increase in the global average temperature to well below 2° C above pre-industrial levels and reaching net-zero global GHGs in the second half of the century [12]. A more recent climate agreement, i.e. Glasgow Climate Pact 2021, aims to reduce coal use and make efforts in great GHG emissions reduction while limiting the rise of global average temperature below 1.5°C above pre-industrial levels by 2050 [13], [14].

In order to deal with the increased emissions due to the extensive use of fossil fuels, the International Maritime Organization (IMO) within the International Convention for the Prevention of Pollution from Ships (MARPOL) set regulations for the prevention of air pollution from ships [15]. The MARPOL Annex VI, firstly adopted in 1997, limits the main air pollutants contained in exhaust gases, such as SO_x and NO_x, prohibits intentional emissions of ozone-depleting substances, as well as regulates onboard incineration and emissions of organic compounds from tankers [16]. Nowadays, MARPOL Annex VI includes two sets of emission and fuel quality requirements: global requirements, and requirements applicable to ships in Emission Control Areas (ECAs), i.e. specific areas of navigation in which emission requirements are stricter than outside them [17], [18]. The SO_x emissions are regulated by the allowed sulphur content in the fuel, which differs depending on the area of navigation (globally or ECAs), while the NO_x emission limit depends on the engine's maximum operating speed. The NO_x regulation standards Tier I and Tier II refer to the global area of navigation, while Tier III is specified for the NO_x ECAs [17]. There are four ECAs established so far (the Baltic Sea area; the North Sea area; the North American area, i.e. coastal areas of the United States and Canada; and the United States Caribbean Sea area, i.e. around Puerto Rico and the United States Virgin Islands) [19], [20], while the Mediterranean Sea is currently considering for the potential ECA [21]. Moreover, there are some specific areas with local regulations, such as Marseille port in southern France which intends to become the Mediterranean's 1st Fully Electric Port by 2025 [22].

One of the most important attempts to reduce CO₂ emissions generated by the shipping sector was the introduction of energy efficiency regulation in 2011 by IMO [5]. The regulation requires every ship of GT = 400 and above engaged in international shipping to have the International Energy Efficiency (IEE) Certificate. In order to obtain it, the ship has to comply with the requirements of the Energy Efficiency Design Index (EEDI) and the Ship Energy

Efficiency Management Plan (SEEMP). The SEEMP must be developed for a ship according to the Guidelines and must be kept on board. The EEDI is a technical measure and requires that for every new ship the attained EEDI must be calculated and must not exceed the required EEDI, which is defined by the EEDI reference line value and the appropriate reduction factor. The EEDI refers to a ratio of the CO₂ emissions produced by the ship power system (numerator), and the transport work, i.e. benefit for the society (denominator) [23], and it aims to regulate CO₂ from the shipping industry [24].

A significant drawback of the existing EEDI regulation is the fact that only one operating point, defined by design speed, is considered as relevant [6]. However, in real ship operations, this speed is very rarely achieved, such as for ships engaged in short-sea shipping, which often change their operating profiles. Furthermore, the calculation of EEDI is based on sea trials at delivery, which are adjusted to calm water conditions. Lindstad et al. [25] concluded that without adjusting tests to include also real-sea conditions (influence of wind and waves), GHGs reduction would not be as much as desired. Since shipping results in pernicious emissions that impact the environment through different processes, Ančić et al. [26] introduced the Energy Efficiency and Environmental Eligibility Index (I4E) which combines different environmental impacts of CO₂, NO_x and SO_x emissions. However, the I4E is applicable only for ships powered by conventional power systems. The accuracy of EEDI to represent the environmental impact of future ship power systems is investigated in a study by Trivyza et al. [27], on the example of a tanker and cruise ship. They performed a comparison of EEDI and lifetime CO₂ emissions for different ship power system solutions with included after-treatment systems and energy efficiency technologies. The results indicated that EEDI and lifetime CO₂ emissions point out different options as optimal, and even for solutions that include greener technologies, EEDI did not manage to describe the real environmental impact of both tanker and cruise ship power systems. However, the study did not investigate any other alternative fuel except natural gas, and the lifetime CO₂ refers to the CO₂ emissions released from the ship operation during the lifetime exploitation period.

In order to expand the energy efficiency requirements on existing ships, in 2021 IMO extended ship energy efficiency regulative with new regulations on the Energy Efficiency Existing Ship Index (EEXI) and Carbon Intensity Indicator (CII), which will enter into force from the 1st of January 2023. Such as its predecessor EEDI, EEXI should be applied for all ships above 400 GT falling under MARPOL Annex VI, but unlike EEDI, EEXI applies to the

existing ships outside EEDI regulations [28], [29]. EEXI refers to the technical measure of energy efficiency, while CII represents the operational measure of energy efficiency and needs to be embedded into SEEMP. CII measures CO₂ emissions per transport work, and it applies on ro-ro passenger, cargo and cruise ships over 5,000 GT [30].

In the literature that deals with the problem of GHGs reduction, the term Carbon Footprint (CF) is often used, which represents a relative measure of the total amount of CO₂ or CO₂ equivalent (CO₂-eq) emissions (involving CO₂, CH₄ and N₂O emissions) caused by indirect or direct activity, or is accumulated over the life cycle of a product [31]. In the maritime sector, some activities that result in GHGs emissions are fossil fuel combustion in a ship engine, energy consumption for shipbuilding, port activities etc., while the total amount of CO₂ or CO₂-eq emissions released through the life cycle of a product (e.g. fuel, ship power system, etc.), represents the total CF of that particular segment and it can be assessed by the Life-Cycle Assessment (LCA) [32], [33]. In their Fourth GHG Study, IMO reported that in 2012, the shipping sector generated 2.76% of global anthropogenic GHGs, while in 2018, this share was 2.89%. The study predicts that without the implementation of rigorous decarbonization measures, the CF of the shipping sector will rise [34].

1.1.2. Emission reduction measures

The required increase in energy efficiency and reduction of the environmental impact of ships can be achieved by the implementation of decarbonization measures, i.e. technical and operational measures. Their implementation leads to the reduction of fuel consumption through the improvement of ship design, reduction of ship resistance, application of energy-efficient power systems, speed reduction, optimised maintenance, etc. [7], [35]. The main technical and operational measures are summarised in Figure 1.

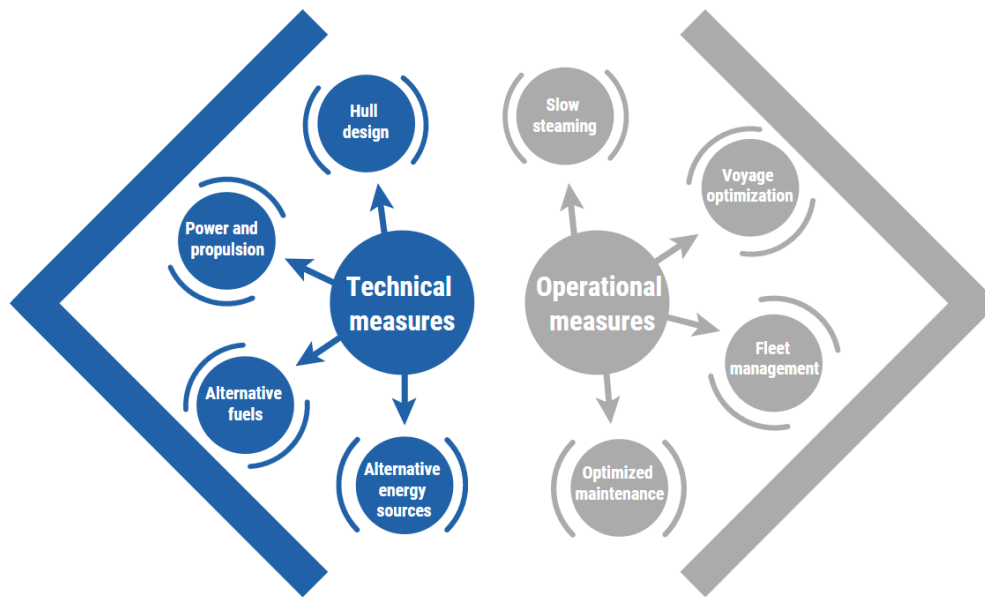

Figure 1. Decarbonization measures for the shipping sector [36]

Technical measures can be divided based on the area of the application: hull design, propulsion and power, alternative energy sources and alternative fuels [7]. The shipping emissions can be reduced by reducing the energy needs of a ship, which is achievable by improving the ship's propulsion system or auxiliary system. The propulsion system can be improved by hull/propeller/speed/route/trim optimisation and the implementation of energy-saving devices, etc. An increase in energy efficiency and reduction of emissions can be done by minimising total losses in the power system, which can be achieved by improving a specific element in the system (e.g. engine) or by rearranging the system (into Hybrid Power System (HPS) or Integrated Power System (IPS)).

Nowadays, the most dominant conventional propulsion system used in the shipping sector is the diesel engine fuelled by Heavy Fuel Oil (HFO) and Marine Diesel Oil (MDO), which have high carbon content and whose combustion results in a great amount of GHG emissions [37]. One of the technical measures relates to the replacement of conventional fossil fuels with alternative and cleaner fuels [38]. This measure has been investigated thoroughly by many researchers in the last years, with a focus on the implementation of natural gas, hydrogen, biofuels, electricity, methanol, etc. [39], [40], [41]. The alternative fuels uptake from 2021 indicates that currently used alternative fuels (methanol, Liquefied Natural Gas (LNG) and battery) are powering only 0.5% of the world fleet, while for the ships on order from June 2021, the share of alternative fuels is 11.84% (ammonia, hydrogen, methanol, Liquefied Petroleum Gas (LPG), LNG, and battery), Figure 2 [42].

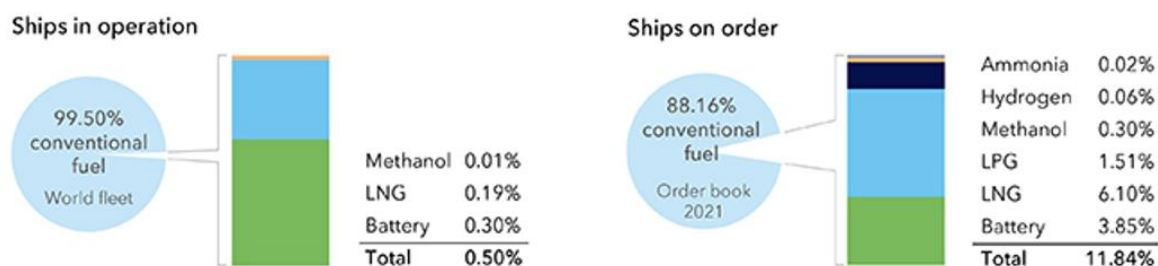

Figure 2. Alternative marine fuels uptake from 2021 (reproduced from [42] with permission of DNV, 2022)

One of the already used alternative fuels in the shipping sector is LNG. Due to its lower sulphur, carbon and nitrogen content, it is significant for use in ECAs. Although its application onboard leads to a reduction of operating costs and emissions, the investment costs, required infrastructure and safety issues are major drawbacks of its use as an alternative fuel [43], [44]. Another issue related to the use of LNG is methane slip which refers to the unburned methane released together with the exhaust gas, which can be successfully eliminated by the implementation of modern engines [45]. Fan et al. [46] investigated the application of LNG in inland navigation ships. In their study, environmental and economic assessments indicated that using LNG in an HPS results in lower overall emissions and costs. Another study that considered LNG as a marine fuel is conducted by Jafarzadeh et al. [47], whose investigation resulted in the conclusion that LNG is a viable alternative for improving the environmental impact of ships.

Another fossil fuel whose application has been widely investigated is methanol. Even though methanol is a toxic, corrosive and fossil fuel, it is sulphur-free fuel with low carbon content [48]. The first methanol-powered ferry was Stena Germanica, powered by methanol and Marine Gas Oil (MGO) and launched in 2015 [49]. Just like LNG, methanol can easily be used in commercially available dual-fuel engines that use a small amount of pilot fuel (conventional fossil fuel) to initiate combustion [50]. To investigate its viability, IMO conducted a study where the environmental impact of methanol and concluded that implementation of methanol is achievable, but its cost-effectiveness greatly depends on the area of navigation, the price of the methanol, and the investment cost [51].

In recent years, biofuels attracted great attention as potential alternative fuels. They are produced from renewable sources such as edible and not edible biomass, vegetable oil or waste. Due to the opinion that CO₂ emissions released from the combustion of biofuels are absorbed by new biomass, which will be further used for biofuel production, biofuels are considered carbon-neutral fuels [52]. A viable solution to reduce the environmental footprint of the shipping sector is to use renewable methanol (biomethanol) [53], [54]. Helgason et al. [55] performed an economic assessment of fossil and renewable methanol compared to HFO and indicated that renewable methanol is expensive, and its application as alternative marine fuels is possible only with subsidies. Matzen and Demirel investigated methanol and dimethyl ether (DME) as alternative fuels obtained from renewable hydrogen and carbon dioxide. Their analysis showed that these alternative fuels achieved an 82-86% reduction in GHG emissions compared to conventional fossil fuels [56].

The ultimate game-changer in the decarbonization of the shipping industry is the introduction of the electrification of ships, where three different types of electrified ships can be identified: a fully electric ship, a plug-in hybrid ship, and a hybrid electric ship. These ships use a small or zero amount of fossil fuel, which results in lower maintenance costs, increased safety, and reduced noise and vibrations, leading to lower disruption of the marine ecosystem [57]. Due to the absence of tailpipe emissions, the most environmentally friendly type of electrification is full electrification [58]. One of the powering options is a rechargeable battery, where the Lithium-ion (Li-ion) battery is perhaps the most significant for the shipping industry, currently having the highest energy density among other commercial batteries [59]. The main drawbacks of full electrified ships are limitations regarding battery capacity, degradation, price, weight and charging, as well as sailing distance [58], [60]. Besides the battery, fully electric propulsion can also be achieved by employing fuel cell technology [61], [62]. While battery-powered ships exploiting current battery technology are suitable only for coastal navigation [58], fuel cell technology has the potential to be used on large and high-power ships that operate on long distances [63].

Use of hydrogen as a marine fuel offer zero-emission shipping. It can be used in gas turbines and Internal Combustion Engines (ICE), but due to its fast electrochemical kinetics, hydrogen is suitable for use in a fuel cell, an innovative technology based on the direct conversion of the chemical energy of fuel into electric energy via electrochemical reactions. By using hydrogen as a fuel for the fuel cells, the only by-product of the reaction is water [64],

[65], [66]. One of the main obstacles to its wider use as fuel is hydrogen storage, which has led to onboard hydrogen production from hydrogen carriers (i.e. natural gas, methanol, ethanol, ammonia, etc.) [67]. The application of fuel cell technology onboard ships is primarily focused on their use to cover the auxiliary needs of ships by combining them in an HPS. Sapra et al. [68] presented the investigated integration of a fuel cell with an ICE for use onboard long-distance ships, while Ahn et al. [69] investigated an HPS, consisting of a marine generator, a Solid Oxide Fuel Cell (SOFC) and gas turbine onboard a large ethane carrier. Recent studies indicate interest in using fuel cells for ship propulsion. Wu and Bucknall focus on the modelling of a plug-in hybrid Proton Exchange Membrane Fuel Cell (PEMFC)/battery propulsion system for a coastal ferry and concluded that this kind of system can significantly reduce GHGs. However, high costs remain an issue [70]. Choi et al. [71] also investigate the ship power system with an integrated PEMFC and battery. Their study presents the detailed development of such a system onboard a ferry in Busan, South Korea. A PEMFC is indicated as a suitable onboard fuel cell for ships that operate near the shore and close to refuelling tanks, while a SOFC is a potential candidate for high-power ships such as cargo ships and cruise ships [63].

The potential of alternative fuels in the shipping sector has been investigated by many studies. Some researchers have been investigating alternative fuels only from an environmental [72], techno-economic [73] point of view or throughout developing their valuation system based on specific criteria such as Prussi et al. [74]. They investigated different factors (e.g. fuel reserves, available infrastructure, emissions produced, etc.) and found a lack of reliable infrastructure for the use of methanol, hydrogen and electricity as shipping fuel and that the future fuel mix would depend on the potential for reductions in GHGs, technology improvement, and the availability and cost-effectiveness of such alternative solutions. Similar research was conducted by Nair and Acciaro [75]. They investigated different fuels for use in the shipping sector and indicated that the viability of alternative fuels depends on the fleet type, technical performance, total costs, environmental impact, and exploitation. In addition, the application of alternative fuels should also be investigated for the geographical area of navigation, which can be accomplished by comparing life-cycle emissions related to the different fuels through the LCA, followed by analysing the total costs related to the implementation of fuel onboard by performing a Life-Cycle Cost Assessment (LCCA) [76], [77], [78]. Moreover, this combination offers sustainable decision-making support for alternative technology implementation that includes environmental and economic criteria [79].

Brynnolf et al. [80] performed an LCA comparison of LNG, liquefied biogas, methanol and biomethanol, and the results indicated that biofuels are a better solution for reducing the CF than replacing conventional HFO with fossil LNG and methanol. A similar study was conducted by Gilbert et al. [81], in which an LCA comparison of alternative marine fuels was performed, indicating that biofuels showed a reduction of 57-79% of GHGs compared to conventional fuels. However, these studies focused only on environmental impact, i.e. life-cycle emissions, as an indicator of whether alternative fuel is suitable for use in the shipping sector. They did not take into account fuel-related costs or other fuels such as hydrogen and electricity. Deniz and Zincir [82] evaluated methanol, ethanol, LNG and hydrogen, based on eleven comparison criteria, which include the costs related to fuels. The fuels are scaled according to the obtained comparison points which are given for each criterion. Due to the safety concerns, bunker capacity, engine performance, the negative effect on combustion chamber components and lower cost-effectiveness, methanol and ethanol had the lowest points. Their results also indicated hydrogen as a potential alternative fuel, but further investigation of its use onboard is required, while LNG was highlighted as the most suitable alternative marine fuel. Even though the authors gave a better insight into the feasibility of the considered alternative marine fuels, they did not investigate their application on a real ship, and their research conclusions are based on a theoretical investigation.

The implementation of Renewable Energy Sources (RESs) onboard ships also leads to the reduction of their environmental footprint. Yu et al. [83] investigated an HPS for sightseeing vessels, consisting of diesel generators, a photovoltaic (PV) system and Li-ion batteries. The observed alternative ship power system resulted in a significant reduction of CO₂ emissions compared with the conventional ship power system. A similar investigation was performed by Yuan et al. [84] where a PV cells-diesel engine-powered ship showed a reduction in both diesel consumption and GHGs. Ghenai et al. [85] presented a ship powered by an HPS consisting of a PV system, fuel cells and a diesel engine, whose application onboard resulted in lower emissions in contrast to emissions released from the ship powered only by a diesel engine. The literature indicated that RESs are not used as standalone, and they are usually integrated within HPS.

Technical measures refer to the design of the ship, while operational measures tend to reduce emissions during the ship's operation, they do not require great investment costs, and their application leads to energy savings. Weather routing, voyage optimization, fleet

management, optimized maintenance, and speed reduction are some of the operational measures that are often used for the reduction of fossil fuel consumption [7], [86]. Voluntary speed reduction way below design speed, i.e. slow steaming, is highlighted among all other operational measures [87], [88]. The advantage of this measure is the reduction of fuel consumption without any investment. However, it is not applicable for ships that follow operating schedules since the reduction of speed increases the time in operation [89].

Each decarbonization measure contributes to the emission reduction at a certain level, but the combination of several different measures would result in even greater emission reduction. By following up the IMO’s decarbonization strategy, according to which ships engaged in international shipping should reduce their annual GHGs emissions by 50% up to 2050, and carbon intensity by 40% decrease by 2030 and 70% by 2050, compared to 2008 levels [34]. IMO’s decarbonization strategy of the maritime sector represents three levels of ambition for achieving its goal: short-term, mid-term and long-term ambitions, Figure 3.

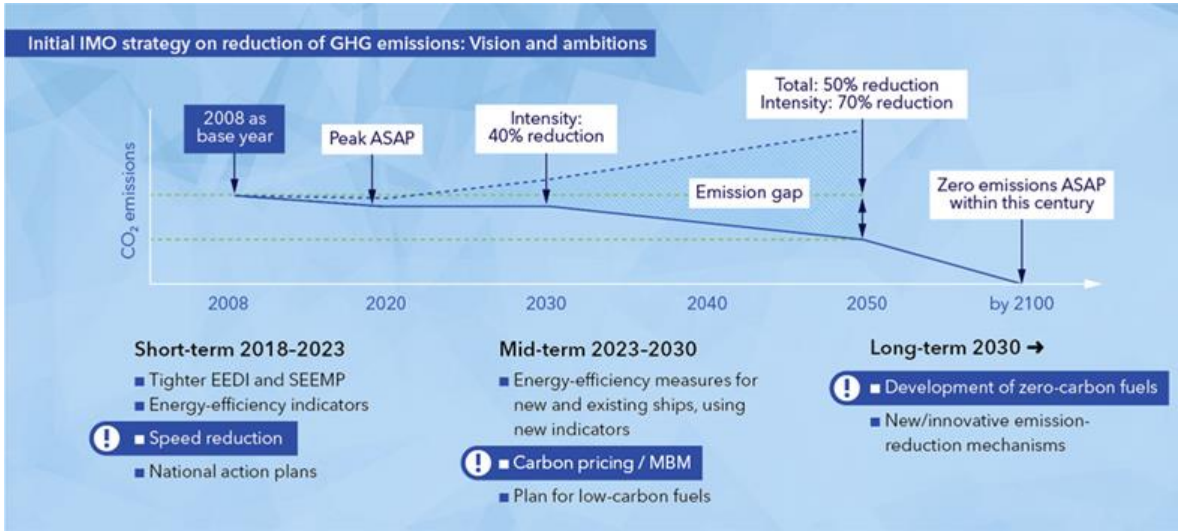

Figure 3. Initial IMO strategy of GHG emissions (reproduced from [90] with permission of DNV, 2022)

The short-term ambition (2018 - 2023) represents measures for the beginning of GHGs reduction either with tighter EEDI and SEEMP, or implementation of an operative measure of speed reduction. The mid-term decarbonization ambition (2023-2030) includes the measures of increasing the energy efficiency for new and existing ships by using new indicators, i.e. EEXI and CII, the implementation of low-carbon fuels, e.g. methanol, and the implementation of Market-Based Measures (MBMs) [90], such as carbon pricing scenarios, which would represent

an economic incentive to replace conventional power systems with alternatives [91], [92]. For the long-term goal of the decarbonization strategy (2030 -), the focus is put on the implementation of innovative emission reduction technologies that could achieve the 2050 goal and further zero-emission goal by the end of the century, together with the implementation of zero-carbon fuels or fuels produced from renewable electricity, so-called E-fuels [90]. Moreover, the satisfactory reduction of 50% GHGs can be achieved with the replacement of a conventional power system with an HPS, which should be constituted of at least one alternative technology that offers zero-emission operation. Further reduction of GHG emissions can be achieved by solely use of zero-carbon fuels, which ensure the absence of tailpipe emissions during the ship operation, and E-fuels, which are considered carbon-neutral fuels [93], [94].

1.2. Motivation

Variable fossil fuel prices and stricter regulations related to environmental protection and the reduction of emissions are some of the challenges that the shipping industry is facing today. Although most of the research on maritime decarbonization is focused on ocean-going vessels, the ships that operate in short-sea shipping and inland shipping sectors should not be neglected. These ships operate near populated areas and spend much time in or near ports, and in that manner, directly impair the air quality of the nearby population [2], [4], [95]. The term short-sea shipping refers to maritime transport between national ports and between a country's ports and the ports of adjacent countries [96], while inland waterway transport represents a mode of transport where passengers and freight are transported by vessels via inland waterways (canals, rivers, lakes, etc.) [97].

Bearing in mind the required emission reduction, the approach for analysis of the energy efficiency should be improved with some decarbonization measures. Even though the primary targets of the regulation are oceangoing vessels, the incentive to increase energy efficiency is also strong for ro-ro passenger ships, engaged in the short-sea shipping sector [3], and inland waterway vessels [98]. In this doctoral dissertation, the procedure for improving the energy efficiency and environmental performance of short sea and inland waterway vessels is developed, taking into account specific exploitation requirements and location characteristics specific to the area of navigation.

The focus group are ro-ro passenger and inland waterway ships that operate in the Croatian fleet since the preliminary analysis indicated that the existing diesel-powered ships are outdated, and it is evident that they need to be modernized in the near future, either by replacement by new ships, or at least retrofit with new power systems. On the one hand, this pressure to reduce emissions represents a burden for shipbuilders and shipowners. On the other hand, it offers an opportunity to introduce new energy-efficient and greener alternative technologies. Implementation of such measures should be performed carefully to maximise the impact of these measures and minimise their costs. In Croatia, shipowners and shipbuilders do not have the necessary experience in fleet modernisation and thus require help in assessing which ship should be improved and how. Therefore, the subject of this research is to identify

which technologies are most suitable for ships engaged in the Croatian short-sea shipping and inland waterway fleets to minimise their environmental footprint at reasonable costs.

1.3. Objectives and hypothesis of the research

The objectives of the research are:

- To define the energy efficiency design index for short sea and inland waterway vessels applicable to ship power systems with alternative energy sources.
- To investigate the availability of alternative energy solutions in the Republic of Croatia and their applicability in the Croatian short sea and inland waterway fleets.
- To develop a design procedure for ship power systems with high energy efficiency, taking into account the specific exploitation requirements of short sea shipping and inland waterway navigation and market regulations in the Republic of Croatia.

The hypotheses of the research are:

- It is possible to define the energy efficiency design index for short sea and inland waterway vessels, which includes multiple operating points and is applicable to power systems with alternative energy sources.
- It is possible to develop a design procedure for the power systems of short sea and inland waterway vessels, which will have higher energy efficiency and lower overall costs than the existing solutions.

1.4. Scientific contributions of the research

The proposed research has the following contributions:

- The energy efficiency design index of short sea and inland waterway vessels in the Republic of Croatia with a high share of alternative energy sources.
- Set of alternative energy solutions applicable in the Croatian short sea and inland waterway sectors.

- Design procedure of high energy efficiency power systems for ships that frequently change operating modes, which predominately are present in Croatian short sea and inland waterway fleets.

1.5. Applied methods

Design procedure of high energy efficiency power systems for ships that frequently change operating modes is developed to select appropriate configurations of ship power systems with alternative energy sources for short sea and inland waterway vessels, which will have more favourable energy efficiency index values over existing solutions within the lifetime period. Based on the following methods, the appropriate ship power systems that satisfy environmental and economic criteria are highlighted:

- **LCA:** assessment of the released life-cycle emissions related to the ship power system during the ships' exploitation period. The observed emissions through the life cycle are divided into three categories. The first represents the Well-to-Pump (WTP) phase which includes the processes of raw material extraction, the production of fuel and its transportation to a pump. The second is the Pump-to-Wake (PTW) phase which refers to the use of a product, and, in this case, the use of fuel for the ship to operate. The third phase is the Manufacturing (M) phase which considers the emissions released and the energy consumed during the manufacturing of the main power system elements (battery, engine, fuel cell, etc.). LCAs are performed by means of the software GREET [99].
- **LCCA:** assessment of the total costs during the ship's lifetime are considered, and they are divided into two groups, i.e. investment costs and operative costs, which relate to the costs of the ship power system operation, i.e. fuel cost, maintenance cost, and equipment replacement cost.

For both methods, the diesel power system configuration represents a baseline scenario. More details on applied methods can be found in the ARTICLES of this doctoral dissertation.

2. Selected results and discussion

This doctoral dissertation presents the development of a design procedure for ship power systems with high energy efficiency, taking into account the specific exploitation requirements of short sea shipping and inland waterway navigation and market regulations in the Republic of Croatia. The research presented in the published ARTICLES can be divided into three milestones that each contribute to the final aim of the development of a design procedure for the selection of ship power systems that results in higher energy efficiency and lower overall costs than the existing solutions. These milestones are:

- The analysis of the Croatian short-sea shipping (ARTICLE 1 [36]) and inland navigation fleets (ARTICLE 4 [100]);
- Analysis of the alternative powering solutions applicable to Croatian short-sea shipping (ARTICLE 2 [101], ARTICLE 3 [102], and ARTICLE 6 [103]) and inland navigation vessels (ARTICLES 4 [100] and ARTICLE 5 [104]), but also the application of developed LCA and LCCA models in a ship design procedure (ARTICLE 7);
- Formulation of energy efficiency index applicable to ship power systems with alternative energy sources (ARTICLE 8 [106]).

This section involves a discussion of key results of the doctoral dissertation, and it is structured into four subsections. In subsection 2.1. the analyses of the Croatian short-sea shipping and inland navigation fleets are presented, while subsection 2.2. involves the analysis of alternative powering solutions and the identification of a set of appropriate power systems that can be used on the selected ships in the Croatian areas of navigation. Subsection 2.3. represents the formulation of energy efficiency that is applicable for ships powered by alternative power systems. In the end, the design procedure for ship power systems with high energy efficiency, environmental friendliness and lower costs is developed.

2.1. Analyses of the Croatian short sea shipping and inland navigation fleets

Global warming and consequently climate changes represent one of the most important environmental problems which the global community is facing nowadays. Climate agreements, such as Paris Agreement and the recent Glasgow Climate Pact from 2021, obliged the countries that have signed and ratified them to the reduction of GHGs emissions, by the mechanisms which need to be included in their national plans on the carbon-neutrality. Among them is Croatia. Due to that, the analysis of CO₂ emissions in Croatia by sector and source from 2019 is performed and presented in Figure 4. According to the International Energy Agency, a major contributor to total CO₂ emissions in Croatia is the transport sector with a share of 43.5%, followed by electricity and heat producers with 18.8%, and industry with 12.5% [107]. According to the European Commission, by 2050 the GHG emissions from transport will need to be at least 60% lower than in 1990. Within the European Strategy for Low-Emission Mobility, three priority areas for action are identified: increasing the efficiency of the transport system and encouraging a shift towards transport modes with lower emissions, the use of alternative energy with an emphasis on electrification, and a transition towards zero-emission vehicles [108].

Transport CO₂ emissions in Figure 4 include released emissions from road transport, railways, civil aviation and navigation, which includes both seagoing and inland waterway vessels. In 2019, road transport contributes 96.4% of total transport CO₂ emissions, while navigation generates 2.4% [109]. Even though the Croatian shipping sector contributes with a small share to overall national GHG emissions, the Croatian Low-Carbon Development Strategy requires its reduction under certain sectoral policies. Measures for the transport sector are similar to those from European Strategy for Low-Emission Mobility and include the use of low-carbon fuels, electrification, optimizing and increasing the energy efficiency of transportation modes, and promoting the sustainable integrated transportation of passengers and freight, i.e. shifting from road to railway and inland waterway transportation [110].

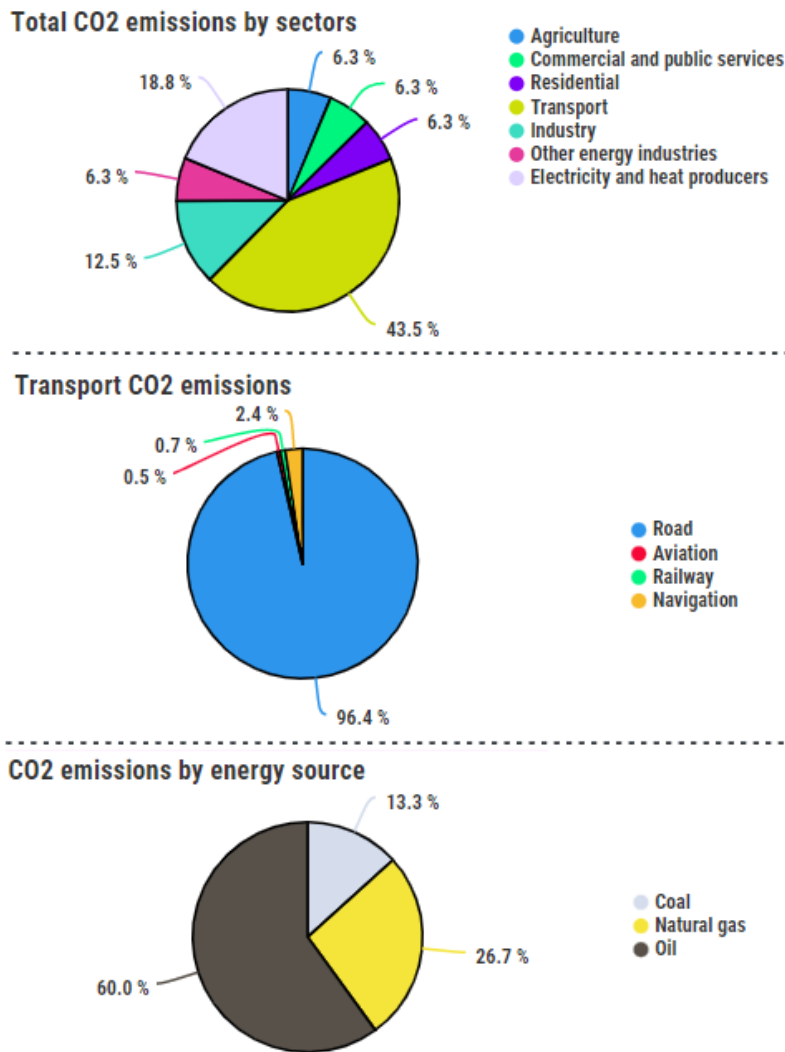

Figure 4. The Croatian CO₂ emissions in 2019 [107], [109]

The main source of the Croatian CO₂ emissions represents the combustion of oil derivatives (with a share of 60%), which are greatly used in the transport sector, followed by natural gas and coal. Most of the Croatian ships are powered by blue diesel, i.e. diesel fuel painted in blue and exempted from excise duty [111], and in that way, the government subsidize the use of fossil fuel. At the Glasgow Climate Change Conference in 2021, the nations are for the first time called upon to phase down unabated coal power and subsidies for fossil fuels [13]. Croatia announced to phase out coal from electricity by 2033, but subsidies for fossil fuels remain until further notice [112].

The Croatian side of the Adriatic Sea has an indented coastline and 1,244 natural formations, of which 78 are islands, 524 are islets, and 642 are cliffs and reefs. Among the islands, 49 of them are permanently inhabited and are connected to the shore and other islands

with many short-sea shipping vessels [113]. Croatia also has an inland waterway network along which navigate inland waterway vessels. Except due to following environmental regulations, the significance of the reduction of shipping emissions also can be found in the fact that these ships operate near populated areas and spend much time in or near ports, and in that manner, directly impair the air quality of the nearby population. Therefore, in this subsection, the results and discussion on the current status of the Croatian short-sea shipping and inland navigation fleets are presented, which represents a starting point for analysing the specific alternative powering options.

2.1.1. Short-sea shipping fleet

The aim of ARTICLE 1 was to perform a preliminary analysis of the Croatian short-sea shipping fleet, i.e. ro-ro passenger fleet, and to indicate the importance of the reduction of its environmental impact. Ro-ro refers to roll on - roll off intermodal transport for vehicles that are driven on and off the ship on their wheels, while ro-ro passenger ships transport both passengers and vehicles [114]. These kinds of ships are usually used for short-sea shipping, while a typical example of such a ship is a ferry.

The analysis reveals that the majority of the 44 ro-ro passenger ships operating on the Croatian side of the Adriatic Sea are outdated. The average ship age is 29 years. In total, 27 ferry lines operating in the Adriatic Sea are analysed in this paper, Table 1. The 21 lines connect the Croatian mainland and islands, one line connects two parts of the Croatian mainland (Ploče-Trpanj), and there are two lines connecting islands (Merag-Valbiska and Lopar-Valbiska), as well as three international lines connecting Croatia and Italy, i.e. Zadar-Ancona, Split-Stari Grad-Ancona, and Dubrovnik-Bari. The investigated ferry lines can be observed in Figure 5, where are presented together with other short-sea shipping routes.

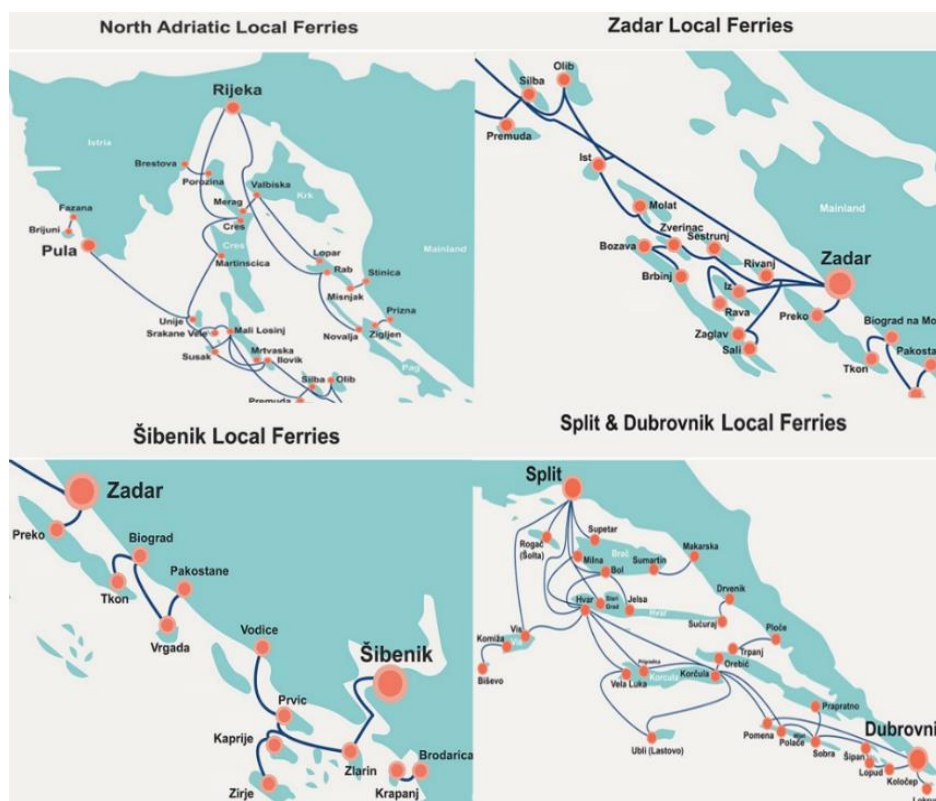

Figure 5. The Croatian routes of short-sea shipping [115]

Table 1. The Croatian ro-ro passenger ships

Area of operation	Ferry line	Ship-operator	Length, l (nm)	Duration, t (min)
North Adriatic area	Valbiska-Merag	Jadrolinija	6.7	25
	Brestova-Porozina	Jadrolinija	5.2	20
	Prizna-Žigljen	Jadrolinija	2.98	15
	Stinica-Mišnjak	Rapska Plovidba	1.7	20
	Valbiska-Lopar	Jadrolinija	28.33	80
Zadar area	Zadar-Ist-Olib Silba-Premuda M.Lošinj	Jadrolinija	118	315
	Zadar-Ošljak-Preko	Jadrolinija	6.4	25
	Biograd-Tkon	Jadrolinija	2.5	20
	Zadar-Rivanj-Sestrunj-Zverinac-Molat-Ist	Jadrolinija	50.8	160
	Zadar-Brbinj	Jadrolinija	29.2	100
	Zadar-Bršanj-Rava-M. Rava	Jadrolinija	35.5	120
Šibenik area	Šibenik-Zlarin-Obonjan-Kaprije-Žirje	Jadrolinija	21.5	80
Split and Dubrovnik area	Split-Vis	Jadrolinija	55.93	140
	Split-Supetar	Jadrolinija	16.4	50
	Split-Stari Grad	Jadrolinija	42.4	120
	Sučuraj-Drvenik	Jadrolinija	6.3	35
	Ploče-Trpanj	Jadrolinija	15.09	60
	Split-Rogač	Jadrolinija	16.5	60
	Sumartin-Makarska	Jadrolinija	12.9	50
	Orebić-Dominče	Jadrolinija	3.4	20
	Drvenik Veli-Drvenik Mali-Trogir	Jadrolinija	17.9	70
	Ubli-Vela Luka- Split	Jadrolinija	260	65.33
	Suđurađ- Lopud- Dubrovnik	Jadrolinija	15	60
	Sobra- Prapratno	Jadrolinija	10.6	45
International area	Zadar- Ancona	Jadrolinija	173	540
	Split-Stari Grad- Ancona	Jadrolinija	245	660
	Dubrovnik- Bari	Jadrolinija	205	570

The energy efficiency performance of a typical ro-ro passenger ship for the Adriatic Sea had already been assessed by Ančić et al. [26] who revealed that this ship does not comply with EEDI requirements, i.e. its CF should be reduced. In this paper, the formulation of the CO_2 Index ($g CO_2 / €$) is performed, which represents a ratio of annual CF, i.e. tailpipe CO_2 emissions, and annual revenue from the tickets. Ferry lines with multi-stops and international ferry lines are omitted from the investigation.

The study revealed the total annual fuel consumption for the ro-ro passenger fleet of the selected ferry lines in the Adriatic Sea is around 9,100 tons, while the annual CF of these lines is around 29,200 tons of CO_2 . The alternative power options to reduce the environmental

footprint were investigated for ferry lines with the highest CO_2 Index, whose comparison is presented in Figure 6.

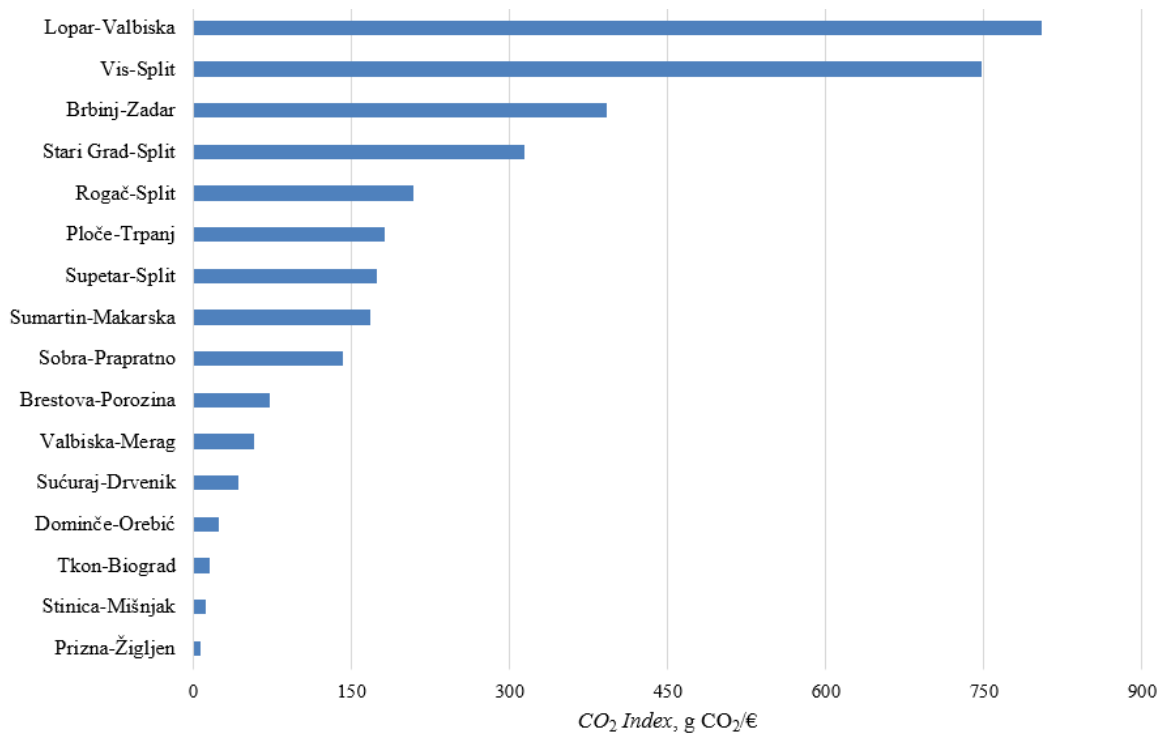

Figure 6. CO_2 Index of the selected ferry lines [36]

According to the results presented in Figure 6, two ferry lines can be distinguished: one connecting the island of Vis and the City of Split (Vis-Split), and the other connecting two islands (Rab and Krk) and their settlements Valbiska and Lopar (Valbiska-Lopar). These ships are further analysed with the implementation of alternative measures such as replacing the diesel fuel with LNG, speed reduction, or implementation of RESs like wind turbines and PV cells to achieve energy savings. The obtained reductions in CO_2 emissions are presented in Table 2.

Table 2. Reduction of tailpipe emissions for each alternative solution [36]

Alternative options	Valbiska-Lopar		Vis-Split	
	Tailpipe emissions, TE (t CO ₂ /year)			
	Current value	Estimated reduction	Current value	Estimated reduction
Speed reduction	1,234	281	2,835	N/A
LNG		247		567
Speed reduction and LNG		472		N/A
Wind power		213		91
Solar power		85		201

The application of the same measure on different ships led to a different reduction in emissions. This is mainly due to different ship energy needs, routes, schedules, but also location climate characteristics. The performed analyses indicated the current status of the fleet and the potential measures for emission reduction. ARTICLE 1 influenced and directed the doctoral dissertation towards the investigation of different alternative power system configurations for ships in the short-sea shipping sector.

2.1.2. Inland navigation fleet

Although the overall aim of ARTICLE 4 was to investigate the electrification of inland waterway ships in Croatia, it also represents a preliminary analysis of the current Croatian inland waterway fleet.

The Croatian inland waterway network consists of the natural streams of several rivers: Danube River (137.5 km), Sava River (446 km), Drava River (198.6 km) and Kupa River (5 km), Figure 7. Geographical position in the centre of Europe represents a great potential for the Croatian inland waterway fleet, but due to different navigation conditions, technical obsolescence, and low capacity, it has been underutilized [116].



Figure 7. Croatian inland waterway network [100]

The considered fleet is comprised of several ship types: dredgers, tugboats (tugs and pushers), passenger ships and cargo ships. The number of specific ships engaged in the Croatian inland waterway fleet and their exploitation characteristics, which determine the ship's economic output and depend primarily on the ship type, are presented in Table 3.

Table 3. The Croatian inland waterway vessels and their exploitation characteristics [100]

Ship type	Number of ships	Exploitation characteristics
Dredger	19	Power, operating time
Tugboat	8	Power, operating time
Passenger ship	8	Speed, number of passengers, route
Cargo ship	3	Speed, capacity, route

A dredger does not have a specific route on which it operates, and its primary task is to arrange the riverbed. Tugboats are ships responsible for pushing and/or tugging ships, barges or other vessels, while cargo ships are used to transport different types of cargo. Passenger ships engaged in the Croatian inland navigation are used to transport passengers where besides the river, some of them operate on lakes located in protected areas of nature and services primarily for the transportation of their visitors. All considered ships are powered by diesel-mechanic propulsion [117].

The analysis indicated that the average age of the ships is around 40 years. According to that, it can be concluded that they will soon need to be replaced by new ships or the currently used power system will have to be replaced with new ones which are more energy-efficient power systems. This represents an opportunity to introduce greener technologies, which is very important bearing in mind the aims of the Croatian Low-Carbon Development Strategy to shift a significant share of road transportation to inland waterways where possible and to introduce alternative fuels and electrification within the transportations sector.

2.2. Analysis of alternative power solutions applicable onboard the Croatian ships

The major part of the considered fleets includes outdated vessels powered by diesel engines that have low energy efficiency and which should be replaced soon following environmental trends. The applicability of alternative powering solutions in the maritime sector depends on the fleet type, ship exploitation requirements, ship technical performance, investment costs, environmental impact, and the geographical location that indirectly determines the availability of alternative options. Alternative fuels uptake presented in Figure 2 indicates that the alternative power systems will become more and more represented in the shipping sector. Therefore, it is necessary to evaluate their environmental impact and economic performance, taking into account the exploitation requirements of the considered ships and their area of navigation.

Within this doctoral dissertation, the full replacement of conventional power systems with alternative power systems was investigated, where the currently used diesel power system configuration represented a baseline scenario. LCA investigated the released emission during the life cycle of a ship power system, while LCCA analysed the total costs of a ship power system during the ship's lifetime. The most environmentally friendly and cost-efficient ship power system is the one with the lowest environmental impact and costs. The system boundary is fixed to the ship power systems, where the emissions and costs are related only to the ship power system, while the other units of the ship, i.e. the hull, additional equipment, crew, port activities, etc., are not taken into account given that they are considered to remain the same while the power is brought to the propeller. In their studies on the environmental impact of alternative power systems, Strazza et al. [118] and Fan et al. [46] also placed their system boundary on a ship power system. This approach is sufficiently accurate to identify technical solutions to reduce emissions generated by the power system.

The analysis of the Croatian short-sea shipping and inland navigation fleet indicated the appropriate ships for further research on the alternative power options. These kinds of ships represent appropriate test cases to investigate the applicability of new technologies in the shipping sector due to the moderate energy requirements and the proximity to the shore.

In order to cover the full range of possible practical applications in the Croatian short-sea shipping sector, representative ro-ro passenger ships that operate on very short (Ship 1), medium (Ship 2) and relatively long routes (Ship 3) were selected, Figure 8. Ship 1 operates on one of the shortest ferry lines in Croatia, connecting settlements Prizna and Žigljen, Ship 2 connects two parts of the Croatian mainland, i.e. Ploče and Trpanj, while Ship 3 operates on one of the longest Croatian ferry lines connecting Split and island Vis. Their technical and operational data are presented in Table 4.

Ship 1



Ship 2

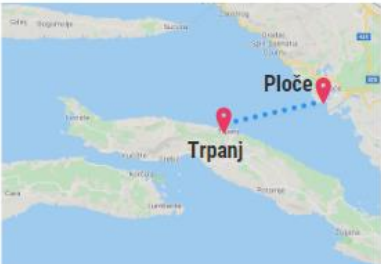

Ship 3

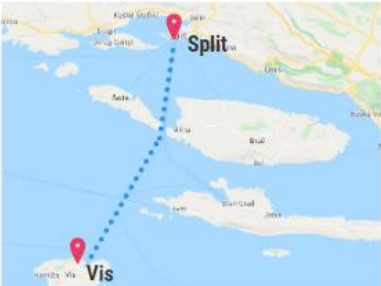

Figure 8. Considered ro-ro passenger ships [102]

Table 4. Technical and operational data of the considered ro-ro passenger ships [102]

	Ship 1	Ship 2	Ship 3
Route	Prizna-Žigljen	Ploče-Trpanj	Vis-Split
Ship name	Prizna	Kornati	Petar Hektorović
Length between perpendiculars, L_{pp} (m)	52.4	89.1	80
Breadth, B (m)	11.7	17.5	18.0
Draught, T (m)	1.63	2.40	3.80
Main engine(s) power, P_{ME} (kW)	792	1,764	3,600
Auxiliary engine(s) power, P_{AE} (kW)	84	840	1,944
Design speed, v_d (kn)	8.0	12.3	15.75
Passenger capacity	300	616	1,080
Vehicle capacity	60	145	120
Trip duration, t (min)	15	60	140
Route length, l (nm)	1.61	8.15	30.2
Annual number of return trips, N_A	1,590	1,740	800
Lifetime, LT (years)	20		

In order to cover all ranges of possible applications in the Croatian inland navigation fleet, the three representatives of the main group of vessels are selected: a cargo ship (tanker), a passenger ship, and a dredger, Figure 9.

Cargo ship "Opatovac"



Passenger ship "Trošanj"



Dredger "Papuk"



Figure 9. Considered inland waterway ships [104]

Each of them operates differently. The cargo ship transports oil between Sisak and Slavonski Brod by navigating through the Sava River. The passenger ship is a small ship that operates in a lake of National Park Krka and transports tourists, while the dredger arranges the river bed and it does not have a specific route. Their technical and operational data are presented in Table 5.

Table 5. Technical and operational data of the considered inland waterway ships [104]

	Cargo ship	Passenger ship	Dredger
Length overall, L (m)	75.9	13.2	68.94
Breadth, B (m)	9.0	4.12	9.30
Deadweight, DWT (t)	967	15.72	484.6
Main engine(s) maximum continuous rating, P_{ME} (kW)	855	236	804
Auxiliary engine(s) maximum continuous rating, P_{AE} (kW)	100	-	476
Total power installed, P (kW)	955	236	1,280
Route length, l (km)	223	5	-
Annual number of trips, N_A	20	2,190	-

2.2.1. Application of alternative marine fuels and RESs

The potential of the application of different alternative fuels in the shipping sector of Croatia has been investigated by ARTICLE 3 (for short-sea shipping fleet) and by ARTICLE 5 (for inland navigation fleet). Both studies analysed the replacement of conventional power systems powered by diesel with different alternative power system configurations. Some of them are presented in Table 6, in which, along with simplified schemes, some advantages and drawbacks of their use as alternative power systems are presented. The most environmentally friendly fuel was identified with LCA, while LCCA was performed to identify the most economically viable solution. Within the cost assessment, the potential implementation of carbon taxation is considered. The carbon cost refers to the cost of a permit to emit CO₂ emissions (i.e. carbon allowance), CA (€/t CO₂) which can be received or bought and even traded, where each allowance gives the right to emit 1 ton of CO₂ or equivalent amount of N₂O and perfluorocarbons (PFCs). Even though carbon credit is not yet implemented in the shipping sector, it is already used for limiting the released GHGs from power plants, industrial factories and the aviation sector which are included in EU Emission Trading System (EU ETS), i.e. carbon market [119]. Recently, within European Green Deal through the "Fit for 55" package, European Commission represented its ambition to reduce net GHGs by at least 55% by 2030, compared to 1990 levels. Since each sector must participate in this climate ambition, it is proposed the extension of the EU ETS to the shipping sector [120]. Four scenarios of the implementation of carbon credit are analysed in this research. According to the data on forecast CA values presented in the World Energy Outlook [121] for 2030 and 2040, the values for each scenario are calculated and presented in Figure 10.

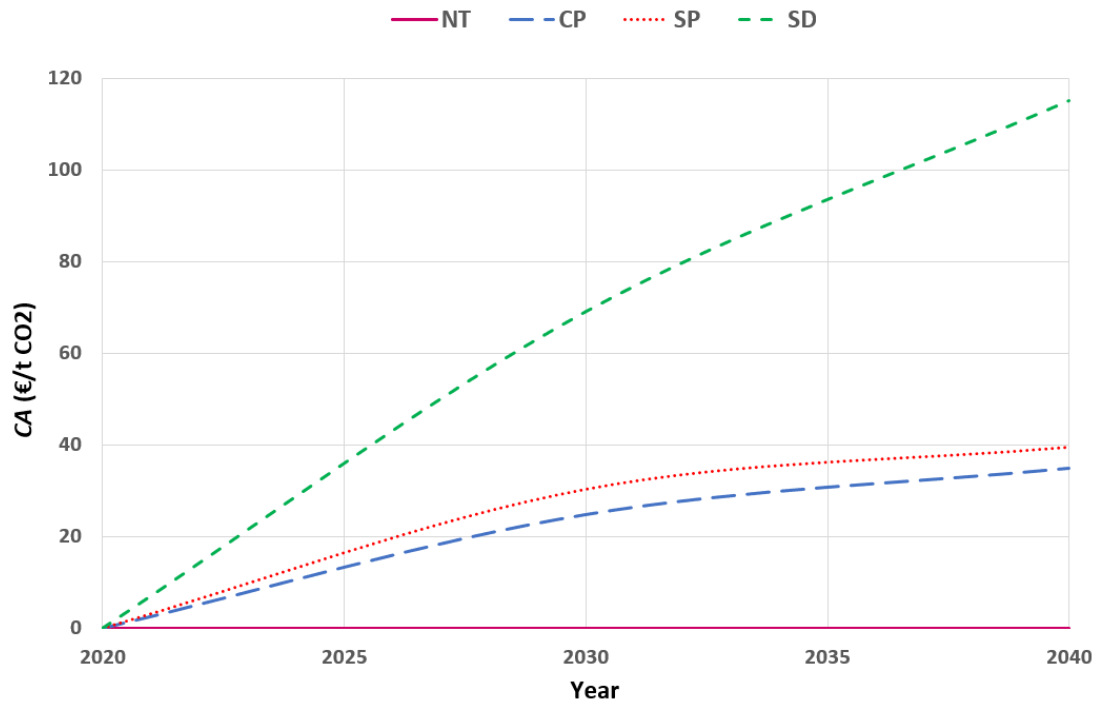
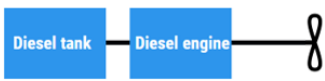
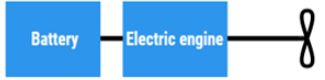
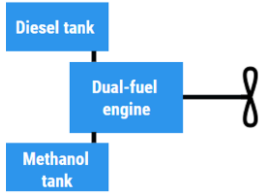
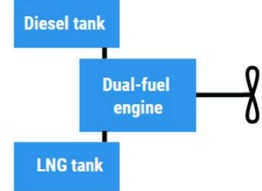
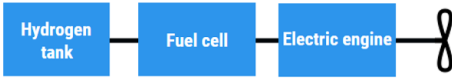
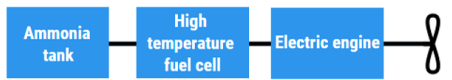
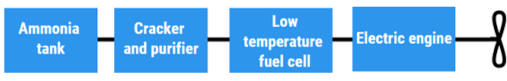



Figure 10. Implementation of the carbon allowance in different scenarios [104]

NT (non-taxation) scenario refers to the current situation when the carbon emission cost is not implemented in the shipping sector, CP (Current Policies) scenario considers current policies implemented in the energy sector, without additional changes in the future, SP (Stated Policies) scenario represents current policies and today's policy intentions and targets, while SD (Sustainable Development) scenario refers to the strategic pathway to meet global climate, air quality and energy access goals.

Table 6. The ship power system configurations with different fuels [105]

Ship power system configurations			
Fuel	Simplified scheme	Advantages	Drawbacks
Diesel		<ul style="list-style-type: none"> • well-known technology • used in most of the vessels • low fuel price 	<ul style="list-style-type: none"> • fossil fuel with high carbon content of 87%
Electricity		<ul style="list-style-type: none"> • enable zero-emission shipping • high efficiency 	<ul style="list-style-type: none"> • limited to short-range coastal vessels • high capital cost
Methanol		<ul style="list-style-type: none"> • carbon content of 38% • available and affordable fuel-grey methanol • integration into existing infrastructure with minor modifications 	<ul style="list-style-type: none"> • toxic fuel • potential leakage can have impact on sea life • high production cost-green methanol
LNG		<ul style="list-style-type: none"> • competitive fuel price • available infrastructure and technology • high-energy density • already used globally • 30% lower GHGs compared to fuel oil 	<ul style="list-style-type: none"> • fossil fuel • storage issues (insulated tanks at -162°C)
Hydrogen		<ul style="list-style-type: none"> • enable zero-emission shipping (in a fuel cell) 	<ul style="list-style-type: none"> • storage issues • absence of supply and bunkering infrastructure • high costs • flammability risk
Ammonia		<ul style="list-style-type: none"> • carbon-free fuel • applicable in ICE and fuel cells • affordable fuel-grey ammonia 	<ul style="list-style-type: none"> • high toxicity-requires safety measures • high operative costs-green ammonia • current production of grey ammonia generates a high amount of GHGs
			
Biodiesel-diesel blend		<ul style="list-style-type: none"> • easy integration in current engines • the share of biodiesel up to 20% requires no engine modifications 	<ul style="list-style-type: none"> • production from edible biomass can result in food crisis • blend combustion results in GHGs

The LCA and LCCA comparisons of different alternatives implemented onboard the Croatian short-sea shipping vessels and inland waterway vessels are presented in Figure 11 and in Figure 12, where D denotes diesel, E denotes electricity, M refers to methanol, DME refers

to dimethyl ether, CNG denotes compressed natural gas, LNG refer to liquefied natural gas, RH represents renewable hydrogen, FH represents fossil hydrogen, BD refers to biodiesel-diesel blend, while AM represents ammonia.

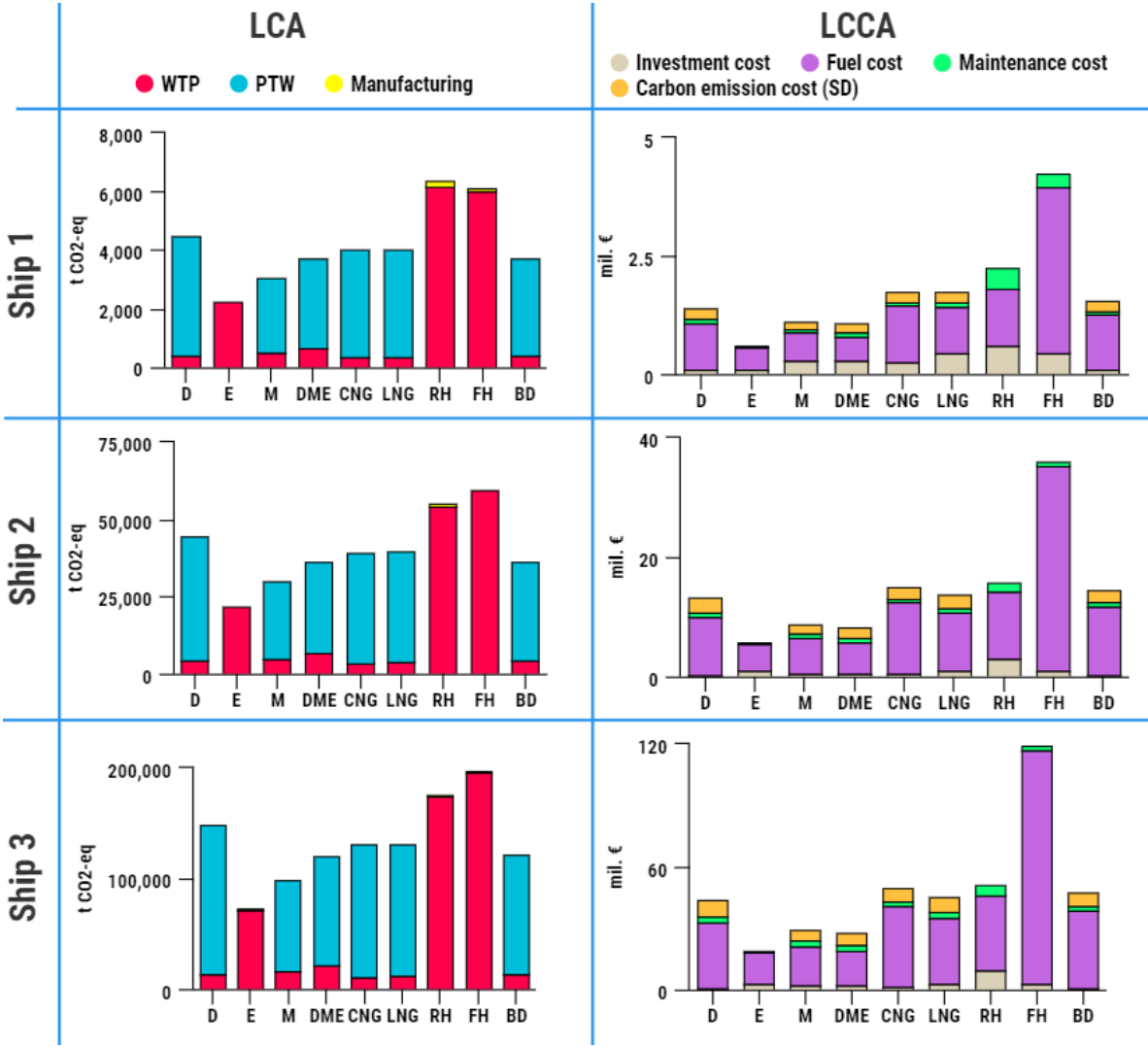

Figure 11. LCA and LCCA comparison of different alternative fuels on board ro-ro passenger ships [102]

Within LCCA, the implementation of the SD scenario of carbon pricing is analysed. At the time of preparing ARTICLE 3 AND ARTICLE 5 in 2020, the carbon allowance value was around 20-25\$/ t CO₂. However, by April 2022, its value grew to the value of 80€/ t CO₂ [122]. The potential implementation of such taxation policy in the shipping sector will force the shipowners and ship operators to implement greener solutions, which would replace conventional power systems.

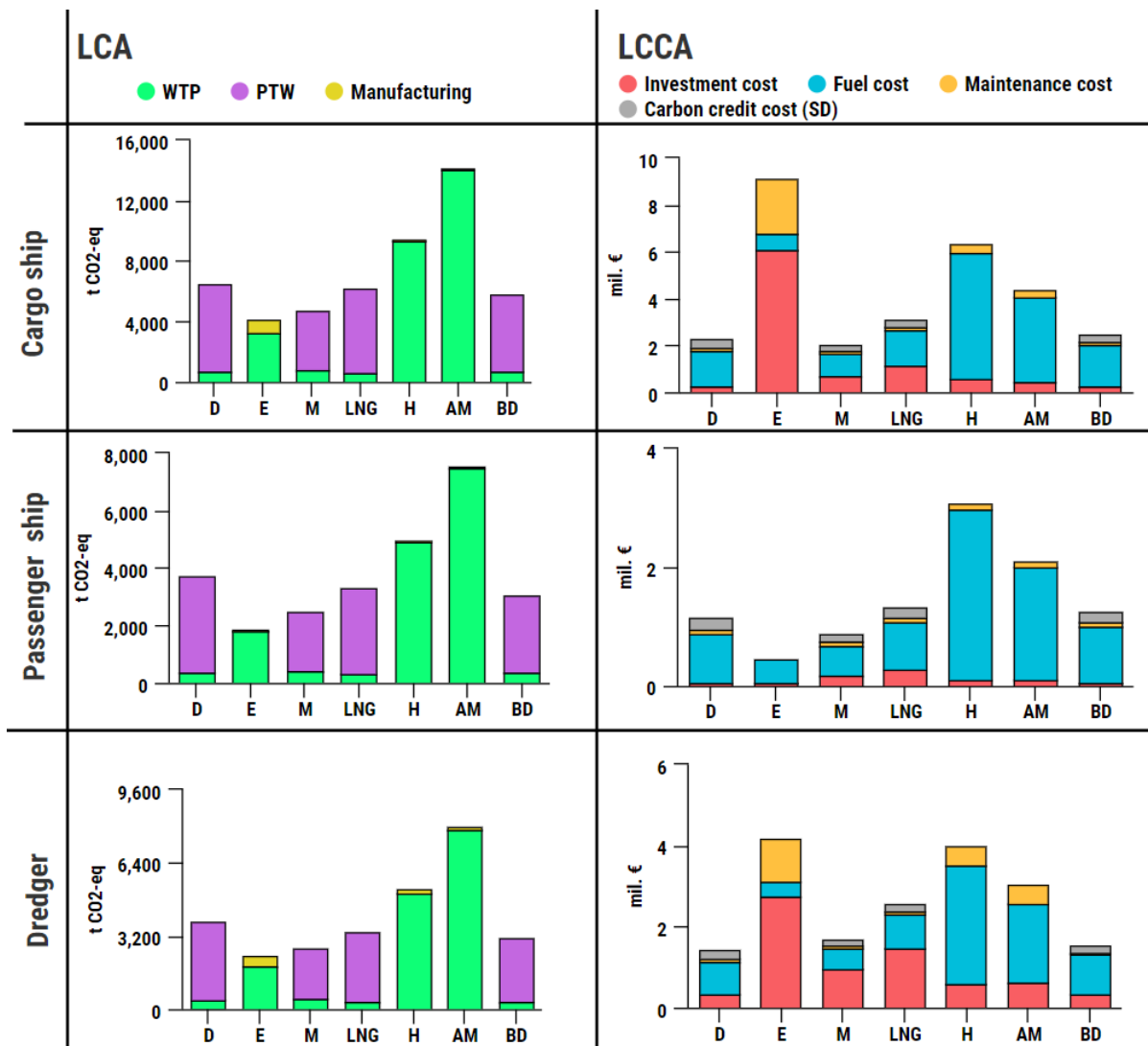

Figure 12. LCA and LCCA comparison of different alternative fuels implemented on inland waterway vessels [104]

The results in Figure 11 and Figure 12 indicated that the replacement of a diesel power system with a fossil ammonia-based or fossil hydrogen-based power system results in the highest amount of GHG emission compared to other alternatives. Hwang et al. [123] have performed an LCA comparison of alternative fuels (MGO, LNG and hydrogen) for coastal ferry operating in Korea and highlighted the hydrogen produced from hard coal to be the alternative with the highest contribution to global warming. Bilgili [72] investigated different fuels (ammonia, ethanol, biodiesel, biogas, ammonia, DME, LNG, LPG, and methanol) for the shipping sector by performing LCA. His results also indicated that fossil ammonia is one of the considered fuels with high environmental impact, while biogas is the most environmentally

friendly option. Since fossil hydrogen and ammonia result in a high negative impact on the environment, the further analysis of different production ways of these fuels and their use onboard ships is investigated in ARTICLE 6. Although in Figure 11 RH refers to renewable hydrogen, it is considered that it is produced onboard from water by an electrolyser, which is powered by a battery. However, this production process requires a lot of energy, and it is not appropriate for the considered ro-ro passenger ships.

The performed analyses for both fleets indicated that the full electrification with only a Li-ion battery onboard ships represents a great option for the replacement of the conventional power system powered by diesel fuel. The LCA highlighted the electricity-powered ships the most environmentally friendly option for each considered ship, while LCCA results showed that for every considered ship except cargo ships and dredgers (due to the required battery capacity), an electricity-powered ship represents the most cost-efficient option. Similar findings regarding the environmental and economic advantages of using batteries for the propulsion of ro-ro passenger ships were provided by Wang et al. [78]. They performed LCA and LCCA comparisons of battery-electric and diesel ferries and confirmed the environmental and economic benefits of the full electrification of ships engaged in the short-sea shipping sector. Another study that confirmed the economic benefit of the use of batteries onboard ferries is conducted by Korberg et al. [73], which performed a techno-economic assessment of advanced fuels for fossil-free ships, where four types of ships are used as a test case: cargo ship, container ship, ferry and bulk carrier. Although the operation of a fully electrified ship provides zero-emission shipping, the life-cycle emissions of such ship are directly dependent on the electricity mix of a country, i.e. energy sources used for the electricity generation, Figure 13. Mix 1 refers to electricity mix with no renewable sources, Mix 3 represents electricity mix with no fossil fuel for electricity production, while Mix 2 corresponds to the Croatian electricity mix.

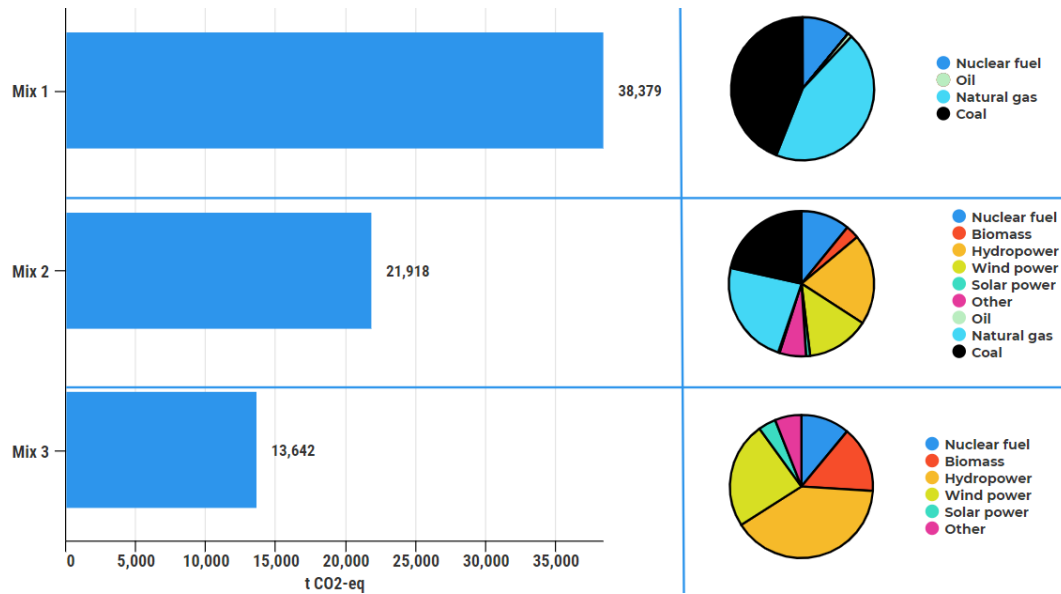

Figure 13. Influence of energy mixes on life-cycle CO₂-eq emissions [102]

The results of the impact of different electricity mix on life-cycle CO₂ emissions of electrified Ship 2 indicated that the share of RESs for electricity generation greatly influences the total CF of the considered power system configuration. Despite that the full electrification of a ship with a battery represents a feasible solution due to the familiar and available technology, many researchers investigate the use of HPS combined with battery and fuel cells (such as PEMFC) to achieve zero-emission shipping [124], [125]. Still, the combination of PEMFC and fuel cell onboard requires higher investment and fuel costs [70] compared to the fully electrified ship.

Another possible fuel for use in the Croatian shipping sector is methanol, whose application in each considered fleet satisfies environmental and economic criteria. Methanol used in a dual-fuel engine with diesel fuel as pilot fuel represents a feasible retrofitting solution for ships [126]. However, methanol is still a fossil fuel whose combustion results in tailpipe emissions and, in that manner, impairs the air quality of the local population around the area where a ship is operating.

The implementation of RESs onboard leads to a reduction of tailpipe emissions. Therefore it is investigated as an alternative option for application on board ships engaged in the Croatian short-sea shipping sector (ARTICLE 2) and inland waterway sector (ARTICLE 4). The exploitation of RESs onboard ships is location-specific, i.e. it depends on the climate characteristics of the area of the navigation. The exploitation of wind energy depends on the wind density of the area of navigation, while the exploitation of solar energy depends on the

solar irradiance of the area of navigation. Although ARTICLE 1 considered the exploitation of wind energy by a wind turbine installed onboard, it is not investigated further in ARTICLE 2 and ARTICLE 4. The main reason for that is the limitations regarding the placement of wind turbines on board ships, the noise and vibrations, and the inability to produce enough electricity during the operation by day since wind density is lower by day and higher during the night.

The exploitation of solar energy by PV system installed onboard the Croatian ro-ro passenger ship (Ship 2, Figure 8) is investigated within ARTICLE 2, while the installation of PV system onboard three inland waterway ships (Figure 9) is investigated in ARTICLE 4. The diesel power system configuration represents a baseline scenario, while fully electrified ships with a battery (with and without PV cells) are considered alternative options. Different power systems onboard considered ships are investigated from the environmental and economic points of view, by performing LCA and LCCA.

The LCA and LCCA results of different power systems onboard a ro-ro passenger ship are presented in Figure 14 and Figure 15.

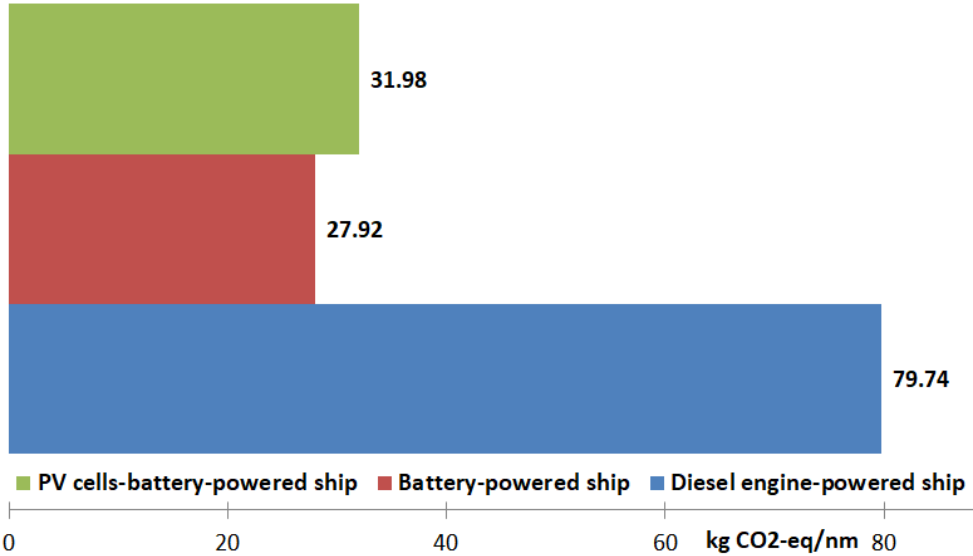

Figure 14. LCA of different power systems implemented on ro-ro passenger ships [101]

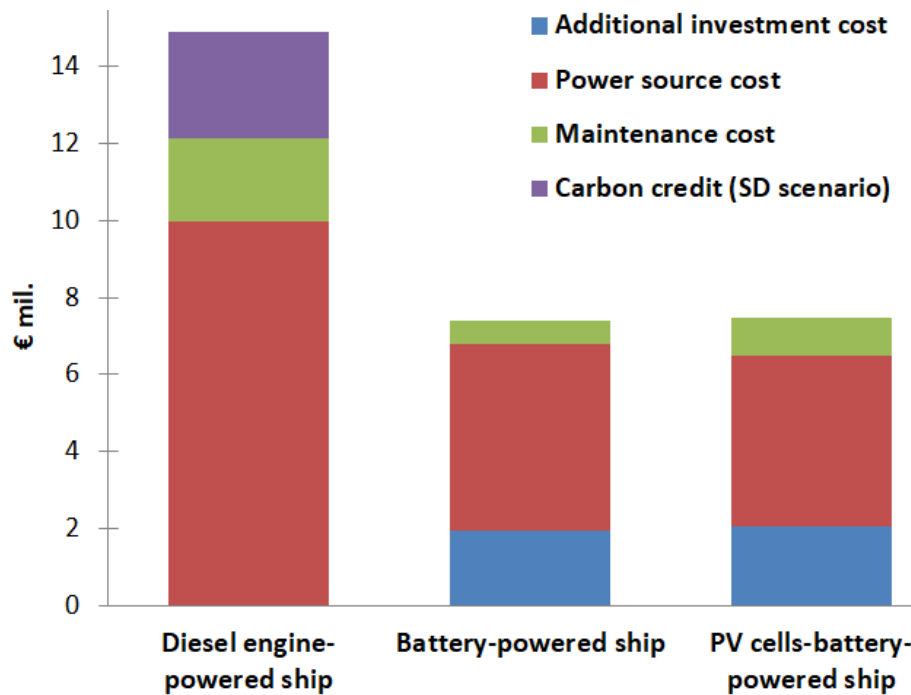

Figure 15. LCCA of different power systems implemented on ro-ro passenger ships [101]

According to the results of the LCA and LCCA comparison, the battery-powered ship is indicated as the most environmentally friendly and cost-efficient option among those considered. Although the installation of the PV system on board in combination with a battery results in reduced GHGs emissions compared to a diesel engine power system, the emissions released during the manufacturing process of the PV system result in slightly higher emissions than those related to the battery-powered ship. A similar conclusion can be conducted for the LCCA results, where PV cells-battery-powered ship results in slightly higher costs because the cost of the PV system is higher than the electricity.

Regarding the inland navigation fleet, the LCA and LCCA results of different power systems installed onboard three vessels are shown in Figure 16 and Figure 17. C, P and D in Figure 16 denote cargo ship, passenger ship, and dredger, while in Figure 17, DE refers to the diesel engine, BAT represents a battery-powered ship, and PV-BAT denotes the combination of a PV system and battery.

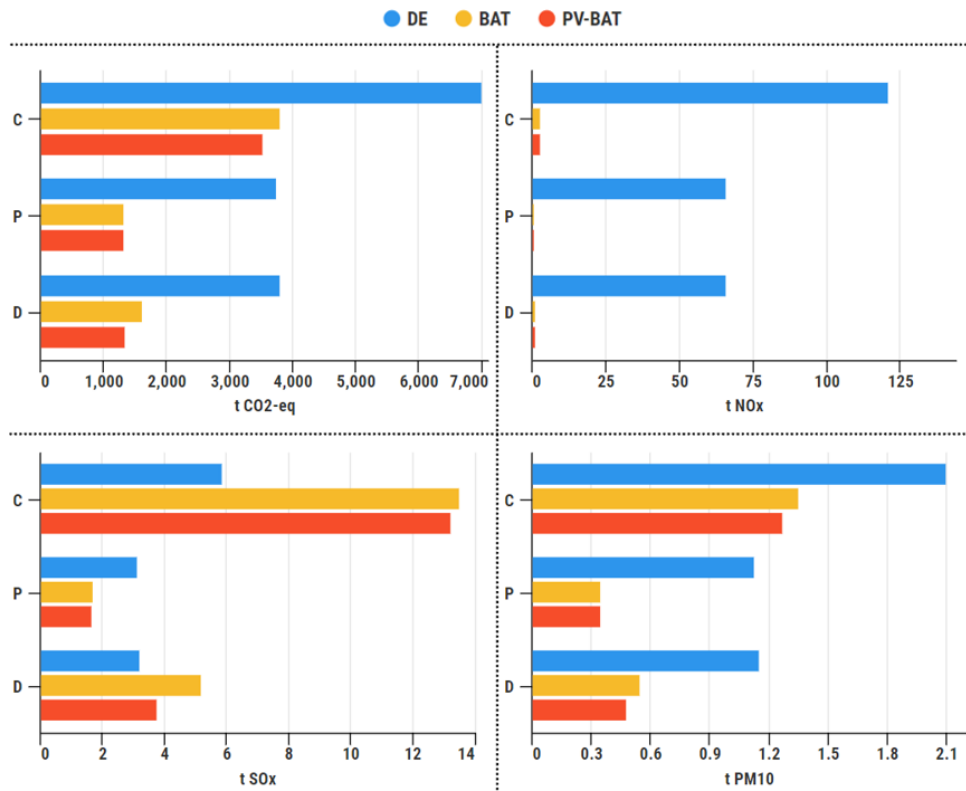

Figure 16. LCA of different power systems implemented on inland vessels [100]

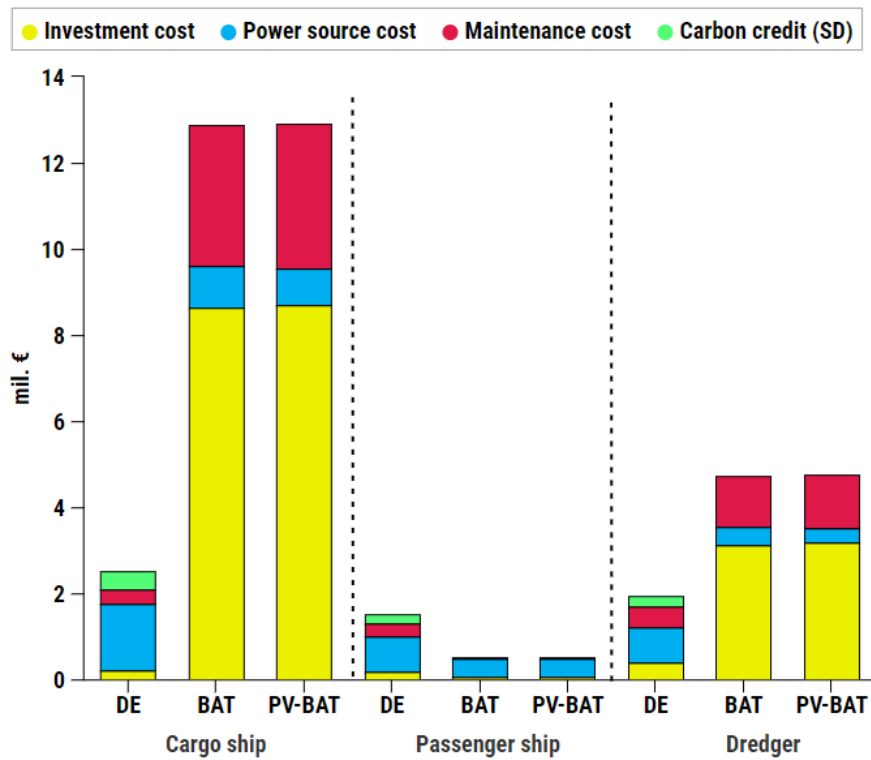

Figure 17. LCCA of different power systems implemented on inland vessels [100]

The LCA results of different ship power systems implemented on considered inland waterway vessels indicated that for the cargo ship and the dredger, the implementation of PV system onboard battery-powered ships results in the lowest GHGs, NO_x and PM emissions, while for SO_x emissions, the lowest impact has diesel engine power system. However, the economic analysis indicated that for these ships the total costs of alternatives are quite high than for diesel-powered ships. Therefore, a PV system implemented onboard a fully electrified ship is not a feasible solution to be used onboard considered cargo ship and dredger. Regarding the passenger ship, both alternatives satisfy environmental and economic criteria, but the battery-powered ship results in slightly lower emissions and costs than the PV cells-battery-powered ship.

2.2.2. Application of fuel cells in the short-sea shipping sector

The application of technologies that result in no emissions, such as fuel cells fueled with zero-carbon fuels, besides having a lower environmental impact, results in a reduction in the negative effect on human health. In ARTICLE 6, the analysis of the implementation of the fuel cells onboard selected ships is more thoroughly performed than in ARTICLE 3.

The study investigates the application of two fuel cells, low-temperature fuel cell (PEMFC) and high-temperature fuel cell (SOFC) fueled with hydrogen and ammonia, as the only power source satisfying the total energy needs of selected ro-ro passenger ships. Based on cleanliness and the type of energy used for its production, hydrogen and ammonia can be classified into three types: grey (fossil fuel), blue (fossil fuels followed by CO₂ capture), and green fuel (produced from RESs) [127], [128], and they are investigated in this paper.

The comparison of different power systems is performed based on different environmental and economic Key Performance Indicators (KPIs), which are determined by the LCAs and LCCAs, Figure 18. *GWP* (kg CO₂-eq) stands for global warming potential, *AP* (kg SO₂-eq) denotes acidification potential, *AFP* (kg PM 2.5-eq) refers to aerosol formation potential, *FED* (%) denotes fossil energy demand, and *NPV* (€) refers to net present value.

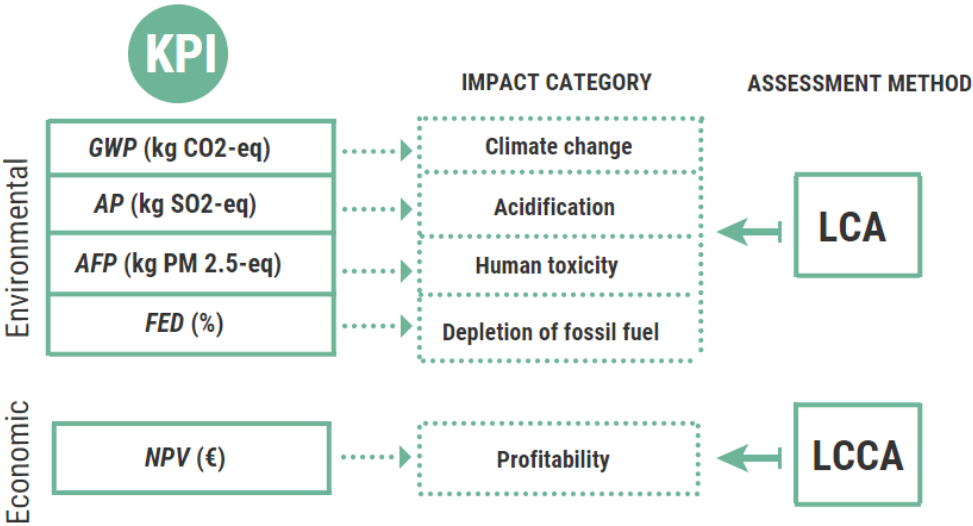

Figure 18. Environmental and economic KPIs [103]

The LCA and LCCA results of the implementation of different fuel cells and fuels are presented in Figure 19 and Figure 20. These results are used to highlight the best environmental and economical options for the fuel cell system on three ships for coastal navigation. In the following results, Gy-H denotes grey hydrogen, B-H denotes blue hydrogen, Gn-H refers to

green hydrogen, Gy-A represents grey ammonia, B-A refers to blue ammonia, while Gn-A denotes green ammonia.

One of the important characteristics of the use of fuel cells for transportation purposes is the start-up period, i.e. period of reaching the required temperature of the system, after which the fuel cell can start to produce electricity [129]. In this paper, two ways of reaching the temperature of the fuel cell system are considered: either the fuel cell is reaching up to the temperature of a system with shore power while it is at berth (onshore) or it is reaching up to the operating temperature during operation when at the same time the battery heats the fuel cell system and power the ship (onboard). However, heating the SOFC onboard Ship 1 (SOFC-onboard) is not considered since the duration of a one-way trip of the ship is shorter than the start-up period of SOFC.

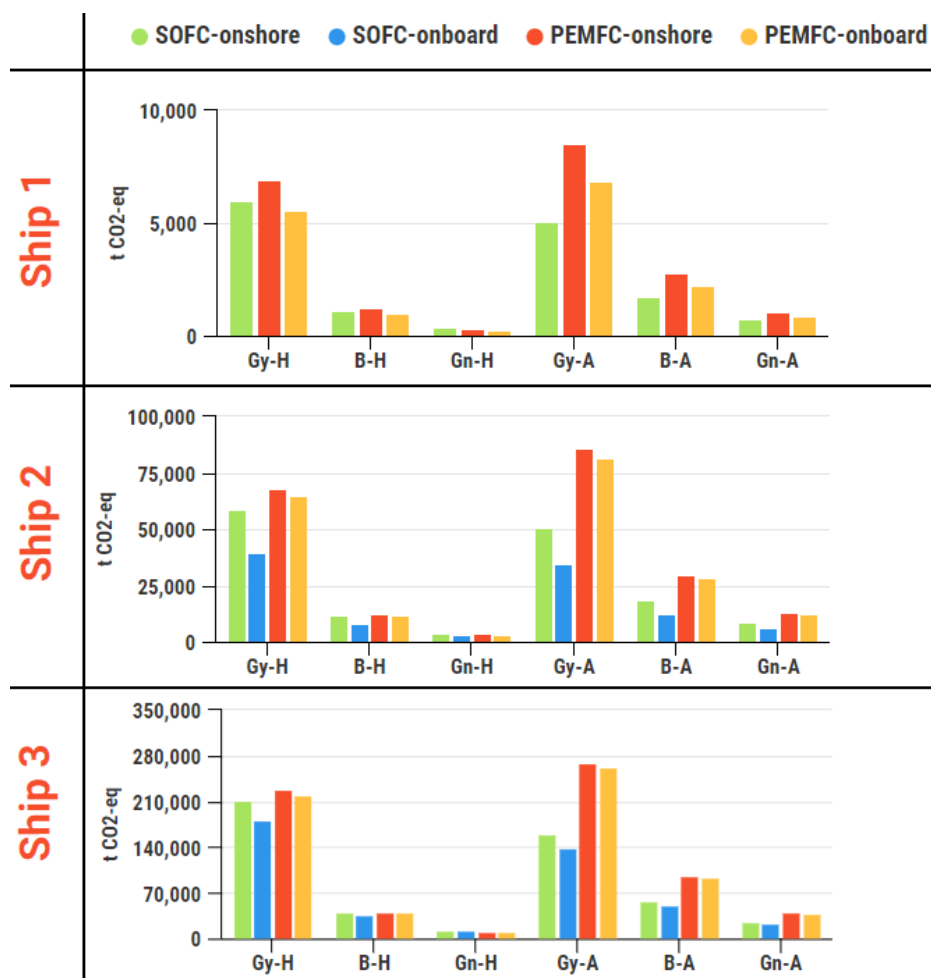

Figure 19. Life-cycle CO₂-eq emissions of the considered fuel cell systems [103]

According to the results presented in Figure 19, the analysis highlighted green hydrogen as the most environmentally friendly fuel solution from a global warming point of view. Before the selected solutions are compared with the performance of a diesel-powered ship, the LCCA results, Figure 20, are observed to conclude which option has the potential to reduce emissions but is at the same time economical.

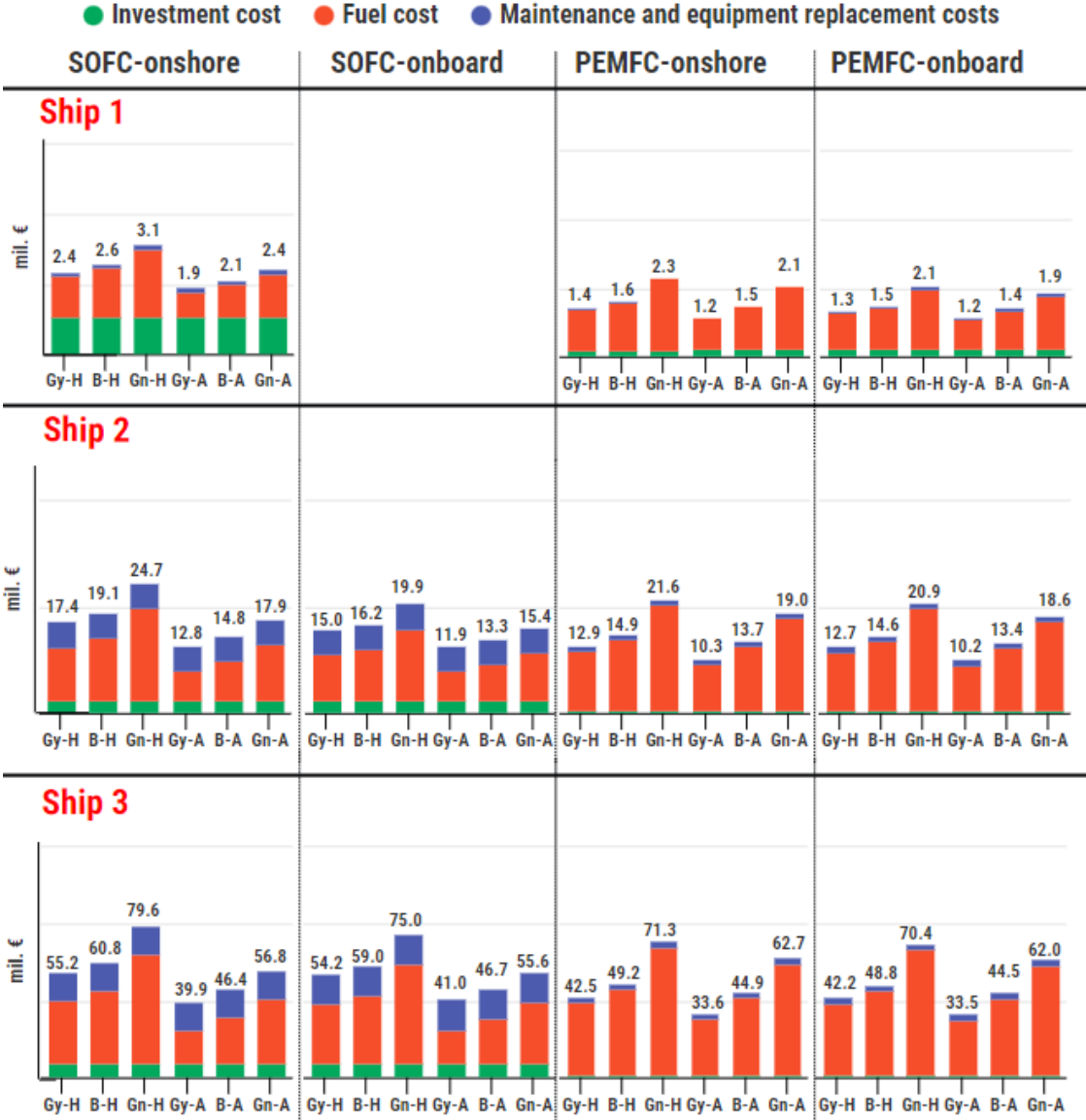

Figure 20. LCCA results of the considered fuel cell systems [103]

Although LCA indicated that green hydrogen is the most environmentally friendly option, the LCCA comparison in Figure 20 showed that green hydrogen results in the highest costs among considered fuels. The LCCA results highlight the grey ammonia as the most cost-

efficient option, while a comparison of PEMFCs and SOFCs for each considered ship indicates that the SOFC system implemented onboard results in higher costs than the PEMFC system.

The selected options for further comparison with the existing diesel-powered ship (denoted as D) are those whose released emissions and resulting costs are among the lowest of the analysed options, i.e. a fuel-cell-powered ship (onboard heated) with blue ammonia, green ammonia and blue hydrogen as fuels. The results of the comparison are presented in Figure 21.

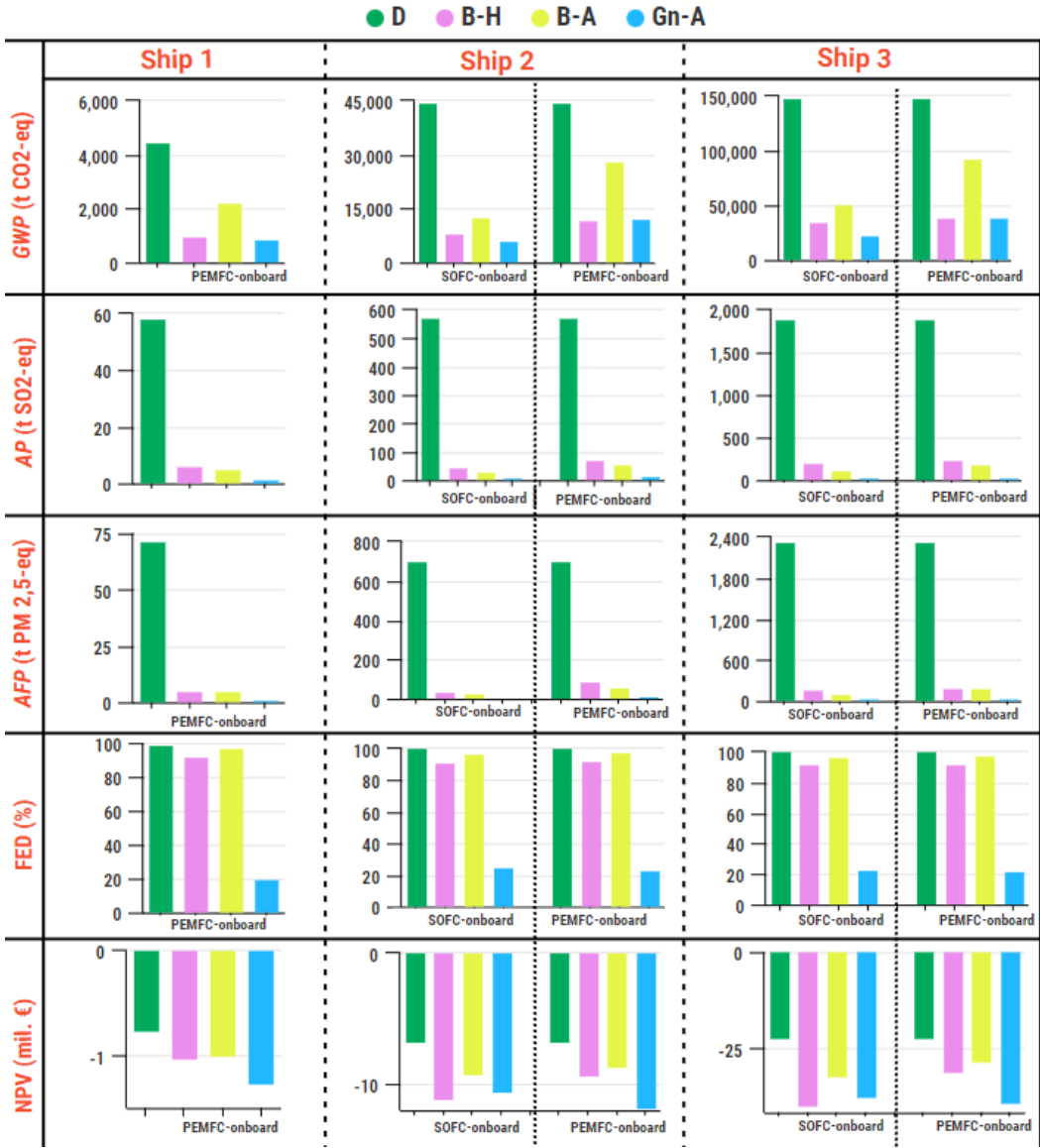

Figure 21. A comparison of the KPIs of different ship power systems [103]

According to the comparison presented in Figure 21, the existing diesel-powered ship has the highest impact on climate change, acidification, human toxicity and depletion of fossil fuel, while the lowest environmental KPIs are calculated for green ammonia. Regarding profitability, the diesel-powered ship represents the cost-efficient option.

In summary, the use of green ammonia, blue ammonia and blue hydrogen in fuel cell systems installed onboard ships are highlighted as potential powering options which can be used to replace the diesel-power system. This replacement results in the reduction of GHGs, but it also increases the total costs. These data are summarized in Table 7.

Table 7. Results of the replacement of the diesel-power system with the considered fuel cell systems [103]

Fuel cell power system	Diesel-powered ship replacement	
	Reduction of <i>GWP</i>	Variation of <i>NPV</i>
SOFC-onboard Gn-A	84% - 86%	56% - 68%
PEMFC-onboard Gn-A	72% - 80%	65% - 75%
SOFC-onboard B-A	65% - 72%	37% - 43%
PEMFC-onboard B-A	37% - 50%	27% - 29%
SOFC-onboard B-H	76% - 82%	64% - 80%
PEMFC-onboard B-H	73% - 78%	35% - 38%

Although the considered fuel cell systems with different fuels are not economical, the fuel cell system with blue and green fuels (hydrogen and ammonia) satisfies environmental requirements. Although blue ammonia is a cheaper fuel than diesel fuel, the lifetime costs of the fuel cell power system are affected by relatively high investment costs (fuel cell, battery, cracker, etc.) and equipment replacement costs. With the further development of supply chains and appropriate infrastructure and a reduction in fuel prices, the fuel-cell-powered ship will become feasible for use onboard the Croatian ro-ro passenger ships.

One of the novelties of this paper can be observed in the analysis of different types of hydrogen and ammonia, based on their origin. Most of the studies that investigate hydrogen and ammonia as fuels for fuel cells onboard consider grey hydrogen and ammonia, and not so many other types of these fuels. Although many researchers investigate separately the global potential of green or blue hydrogen/ammonia as energy carriers [130], [131], [132], just a minority of them investigate their use of them in the shipping sector. In their study, Atilhan et al. [133]

investigated green hydrogen for the shipping sector by comparing the characteristics of hydrogen with other fuels but also by performing a cost and environmental comparison of the production of grey, blue, and green hydrogen based on different production technologies. The results indicated that green hydrogen represents the best environmental solution, but its cost is 3-4 times higher than grey hydrogen. Fernández-Ríos et al. [134] analysed the environmental sustainability of alternative marine propulsion technologies powered by hydrogen (use of hydrogen in an ICE and fuel cells (PEMFC)) with a life-cycle approach. In addition to grey, blue and green hydrogen, the authors also investigated the hydrogen production from waste from a coke oven, which in the LCA results resulted in the highest GHGs emissions. In a comparison of different environmental categories with diesel as a baseline scenario, both hydrogen-based technologies offer a feasible replacement for diesel fuel, but the use of hydrogen in an ICE results in lower emissions than the use of the fuel in a PEMFC. Even though both of these studies investigated hydrogen as a fuel for the shipping sector and highlighted the importance of the fuel origin in the environmental assessments, they did not investigate the application of fuels on a particular ship in operation.

Another scientific contribution of ARTICLE 6 can be observed in the simultaneously technical, environmental and economic comparison of different fuel cells onboard ships. Usually, researchers investigate only one type of fuel cell for the application onboard ships, either their use for the propulsion or auxiliary power of the ship [85], [135] or they compare different fuel cell types according to different criteria (e.g. safety, efficiency, lifetime, cost, emission) which are not referred to the use of a particular fuel cell onboard particular ship [66].

2.2.3. Applicability of developed mathematical models for environmental and economic assessments

The practical applicability of the newly developed mathematical models for the analysis of lifetime emissions and lifetime costs of different power systems is illustrated in ARTICLE 7, where the modular concept in the design of small passenger vessels for the Mediterranean was investigated. The considered ship is assembled from three virtual modules (hull, power system and superstructure), enabling different vessel characteristics (speed, capacity, environmental performance, habitability, etc.). The procedure for such ship design is presented in Figure 22, in which the power system design methodology is incorporated, and the developed LCA and LCCA models for the identification of appropriate power systems are used.

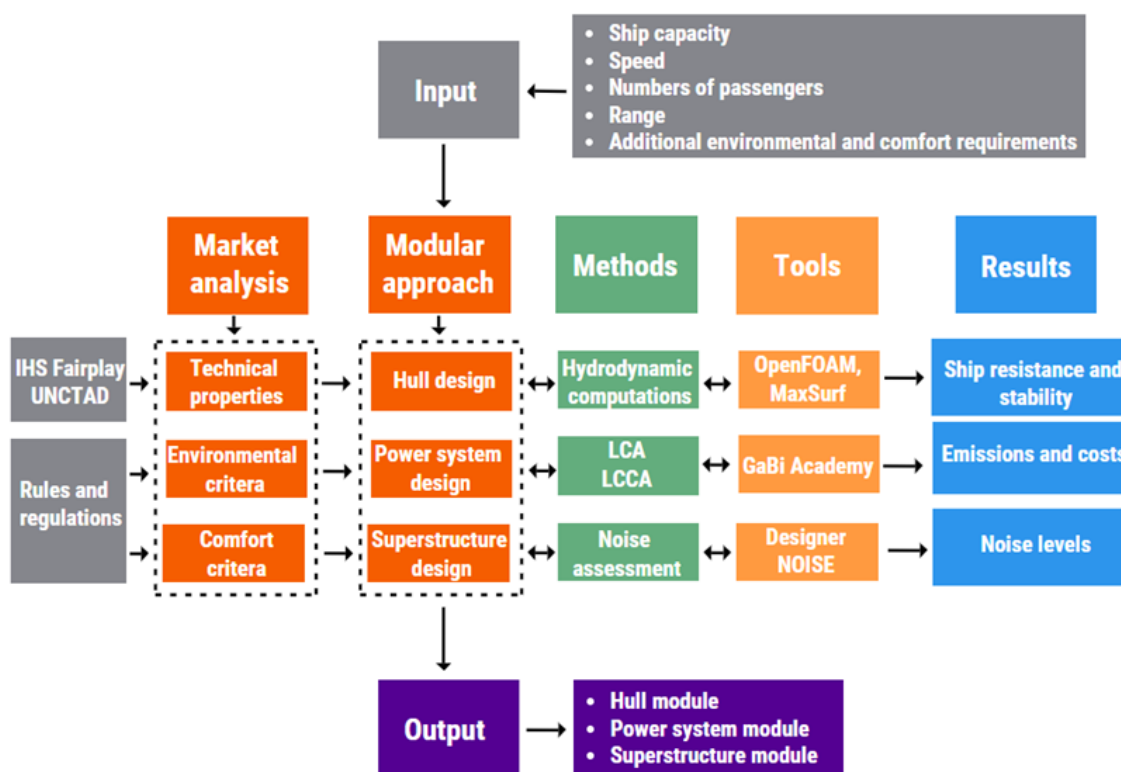

Figure 22. The ship design procedure based on the modular concept [105]

To identify the optimal power system that satisfies environmental and economic criteria when implemented onboard a small passenger ship operating in the Mediterranean, the LCAs and LCCAs of several power systems (Table 6) are performed. The results of their comparisons are presented in Figure 23.

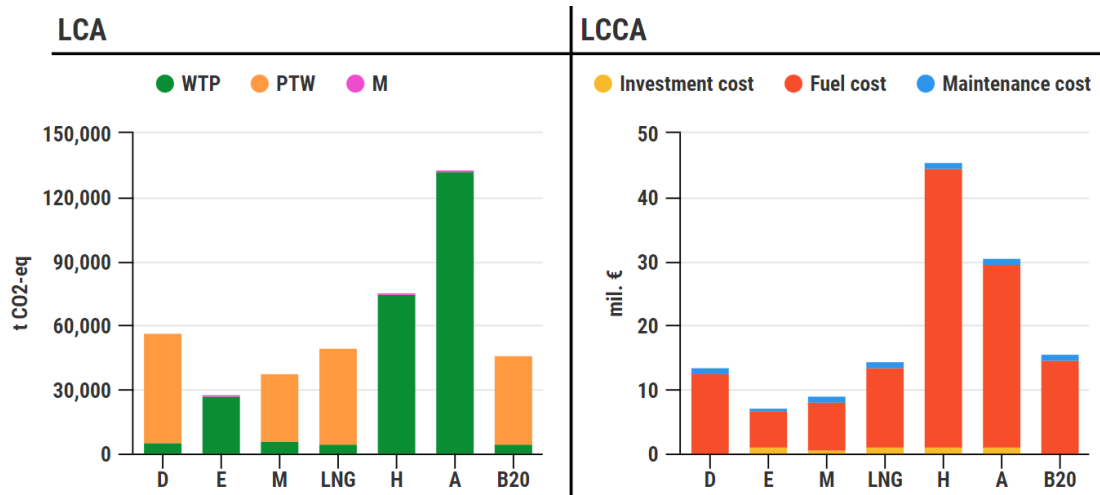

Figure 23. Identification of appropriate power system within the modular approach in the design of small passenger ships for the Mediterranean [105]

Although instead of GREET, the LCA is performed by means of GaBi Academy software, the used models for investigation of life-cycle emissions and lifetime costs identified full electrification as the most environmentally friendly and cost-efficient power system option. The electrification results in very low noise and vibrations, leading also to comfort benefits.

2.3. Formulation of energy efficiency index applicable to ship power systems with alternative energy sources

The environmental regulations are pushing the maritime sector towards a reduction of its environmental footprint and an increase in energy efficiency. As elaborated in the introduction section and presented in subsection 2.2., the implementation of alternative fuels represents the great potential to significantly reduce GHG emissions, especially if the implemented fuels have low carbon content. According to the guidelines for the calculation of EEDI and EEXI, energy efficiency represents the ratio of tailpipe emissions released during the operation of a ship and the benefit to society, i.e. economic output. However, the implementation of zero-carbon fuels (ammonia, hydrogen, and electricity) results in the absence of these emissions. Therefore, in ARTICLE 8, the formulation of the energy efficiency index applicable for ships with alternative powering options is presented.

ARTICLE 8 proposed a mathematical model for simultaneous assessment of ship energy efficiency and environmental friendliness, which can be applied not only to diesel engine-powered ships but to a range of alternative powering options. Besides diesel, five alternative fuels are investigated, i.e. electricity, methanol, LNG, hydrogen and ammonia. For this purpose, the calculation of the I4E index presented by Ančić et al. [26] is extended to the complete fuel pathway by using a life-cycle approach.

To investigate the environmental impact and energy efficiency of ships powered by alternative power systems, I4E presented in [26] is modified into the energy efficiency and emission index (*E EI*):

$$E EI = \frac{\alpha \cdot GWP + \beta \cdot AP + \gamma \cdot EP}{BS}, \quad (1)$$

where an evaluation of different emission contributions is performed by involving *GWP*, *AP*, and eutrophication potential (*EP*), while *BS* refers to the benefit for the society. The contributions of individual potentials to an environmental impact of a ship are considered with the weighting factors (α , β and γ). Their selection depends on the area of application [136].

The emissions (*E_i*) released by different power systems are analysed by the LCA by considering three impact categories, i.e. global warming, acidification and eutrophication.

GWP represents a measure of how much energy the emission of one ton of a gas will absorb over a given period relative to the emission of 1 ton of CO₂. It is calculated by multiplying CO₂-eq factors over 100 years (CO₂: 1; CH₄: 36; N₂O: 298) [137]:

$$GWP = (1 \cdot E_{CO_2} + 36 \cdot E_{CH_4} + 298 \cdot E_{N_2O}). \quad (2)$$

AP is calculated by multiplying the emissions of a particular acidifying gas by the SO₂-equivalence factors (SO₂-eq) (SO_x: 1; NO_x: 0.7), as in the following equation [138]:

$$AP = 1 \cdot E_{SO_x} + 0.7 \cdot E_{NO_x}. \quad (3)$$

EP is calculated by multiplying the NO_x emission with the PO₄-equivalence factor (PO₄-eq) (NO_x: 0.13) according to the following equation [138]:

$$EP = 0.13 \cdot E_{NO_x} \quad (4)$$

The method for the calculation of *EI* for a ship with alternative power systems is presented in Figure 24.

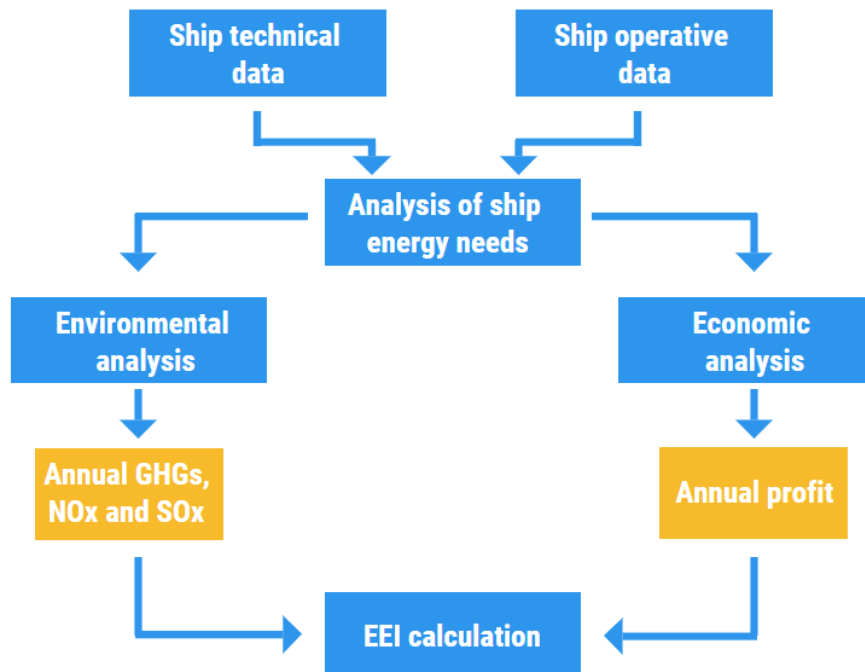

Figure 24. The method for the calculation of *EI* [106]

In the first step of the method, ship data related to the ship design and operation are required for the analysis of the ship's energy needs. The obtained results represent inputs for environmental and economic analyses, whose results are annual emissions and annual profit, which are used to calculate different environmental impact potentials (*GWP*, *AP*, and *EP*), and finally, lead to the calculation of *EEI*.

The applicability of the model is illustrated in the Croatian ro-ro passenger fleet, Figure 25. In this study, the weighting factors ($\alpha = 0.095$; $\beta = 18.3$; $\gamma = 21.1$) are obtained from the study by Ančić et al. [26], which also considers the ro-ro passenger ships, while *BS* is calculated by economic analysis, which includes annual revenues from the tickets and annual expenditures related to ship operation, i.e. investment cost, fuel cost, maintenance cost and equipment replacement cost.

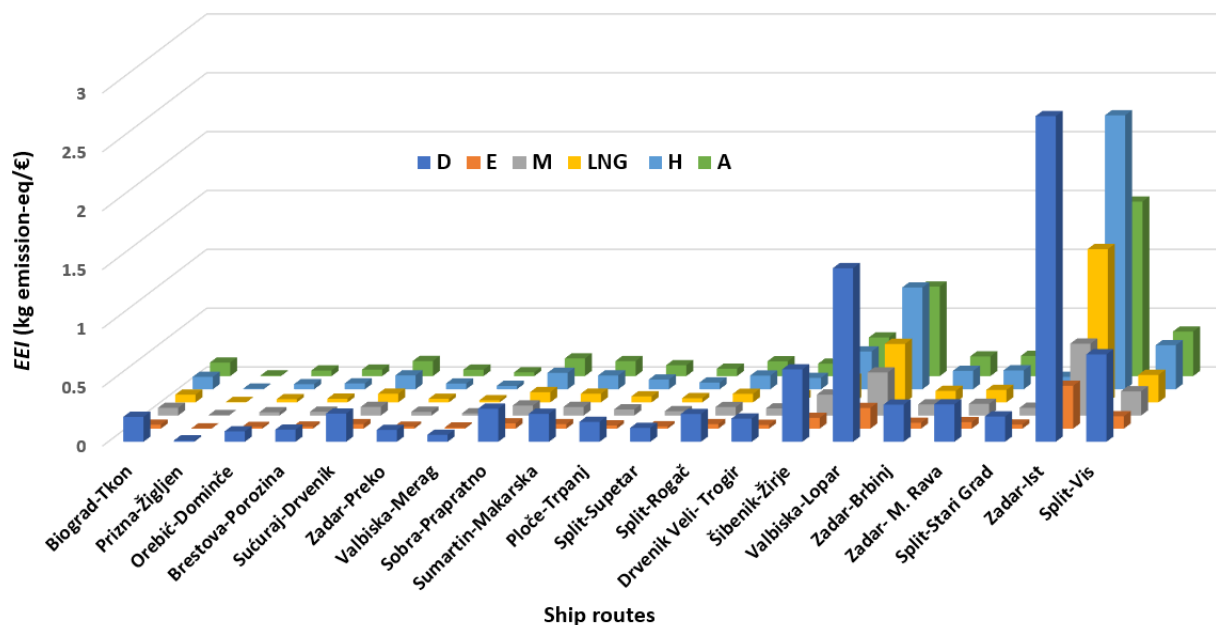

Figure 25. Calculated *EEI* for ships with different power systems [106]

Some of the ships engaged in the considered fleet are omitted from the analysis since they turned out to be unprofitable, i.e. their annual costs are higher than their annual income. It is considered that the ship with an alternative power system is energy efficient and environmentally friendly if its *EEI* is lower than the *EEI* of a diesel-powered ship, which is currently used in selected ships. According to the results presented in Figure 25, each considered alternative solution represents a better power option than the diesel-powered ship.

Due to the low emissions and high *BS*, full electrification with only a Li-ion battery is the most energy-efficient and environmentally friendly option among those considered.

Within this doctoral dissertation, the *EEIs* are calculated for existing ships operating at an average speed, which is more appropriate than the calculation of *EEIs* with a design speed since most of the ships operate in different regimes. To take into account navigation at a different speed, a set of operating points is defined, which are related to the reduction of the design speed by 20% (0.8vd), 40% (0.6vd), 60% (0.4vd), and 80% (0.2vd). Their impact on CO₂-eq emissions and *BS* are illustrated on the selected ro-ro passenger ships (Figure 8), while the results are presented in Figure 26 and Figure 27.

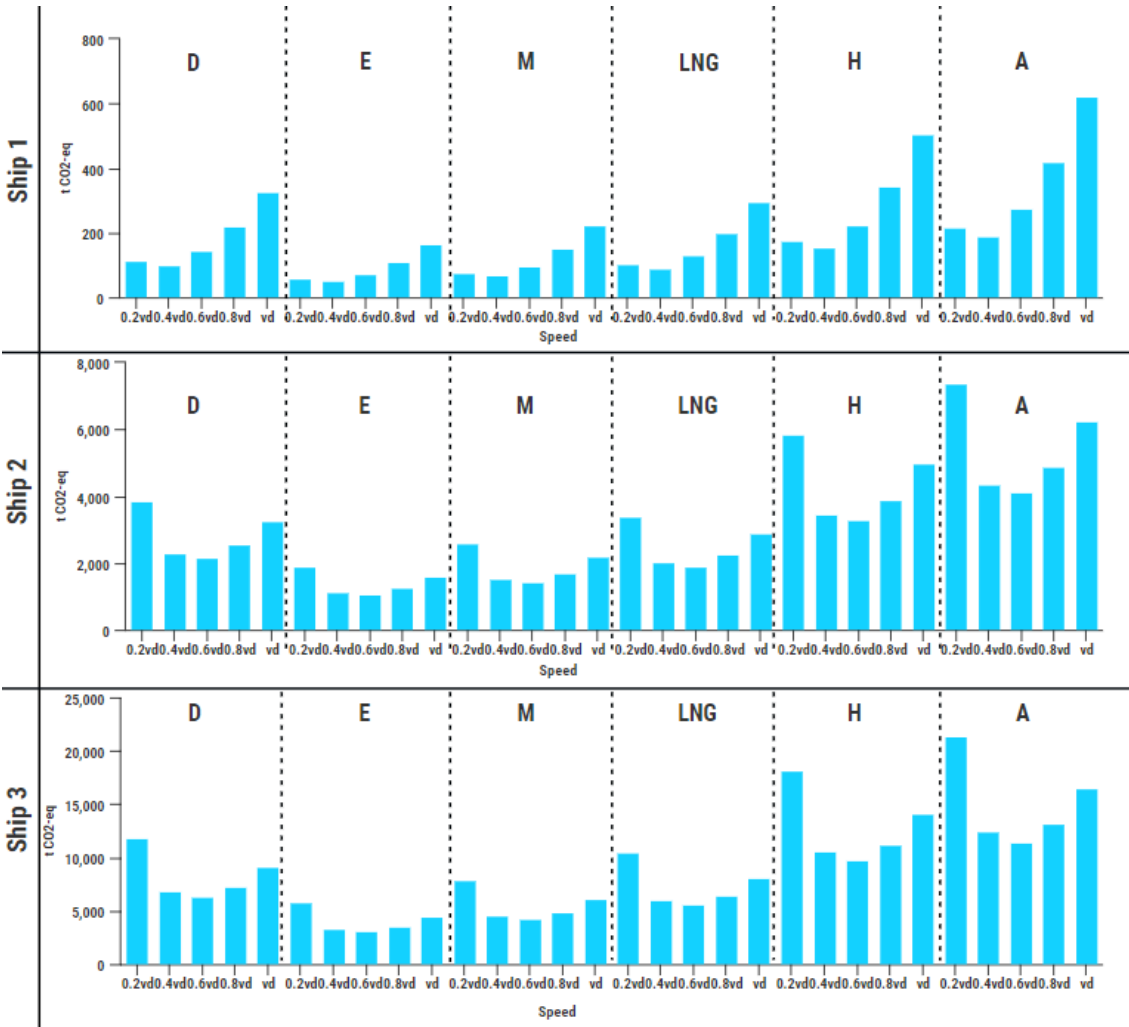

Figure 26. Impact of speed reduction on annual CO₂-eq emissions of ships with different power systems [106]

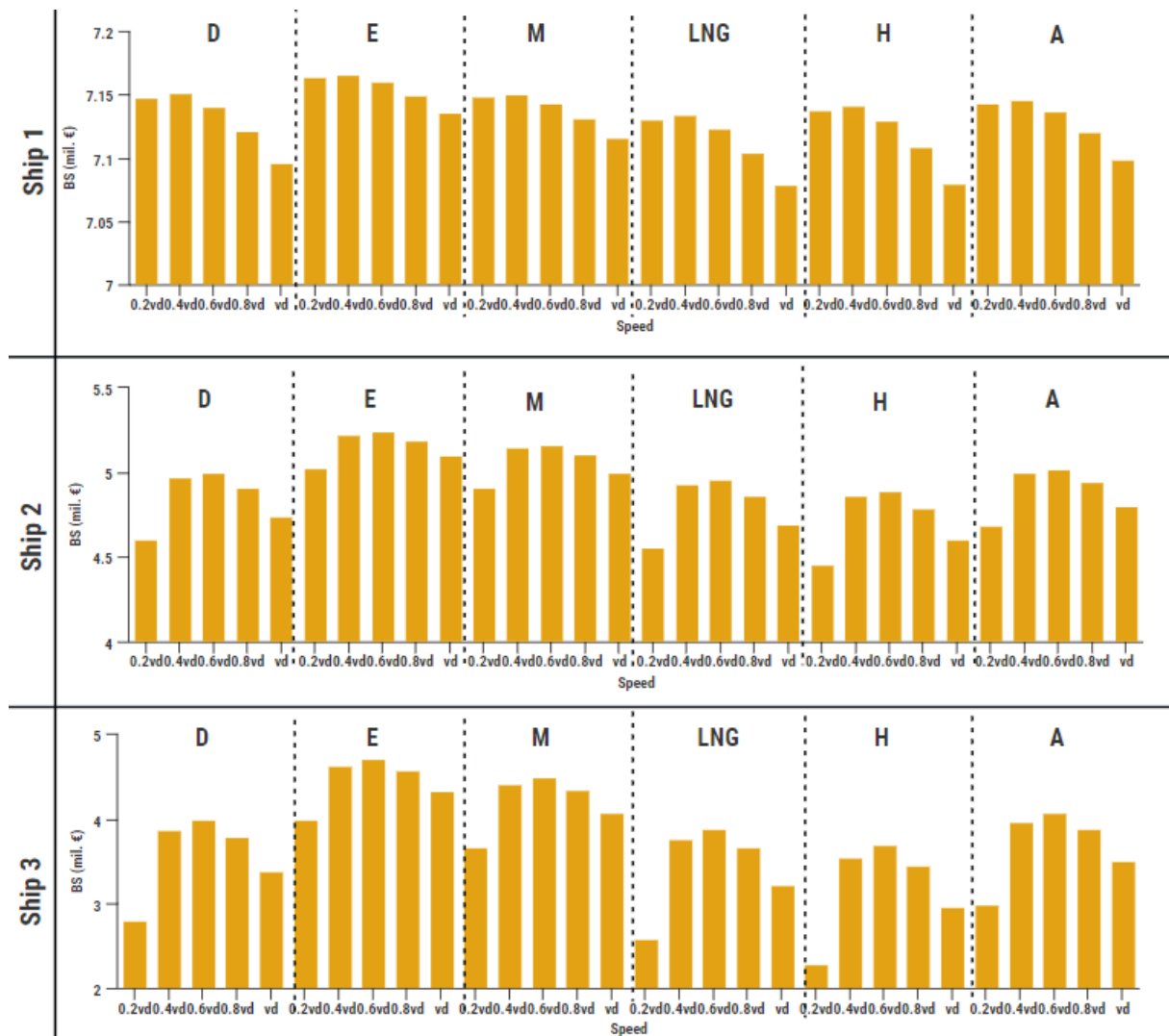

Figure 27. Impact of speed reduction on annual economic profit of ships with different power systems [106]

The results presented in Figure 26 and Figure 27 indicated that, with the speed reduction of 60% for Ship 1, and speed reduction of 40% for Ship 2 and Ship 3, the emissions and costs reach their minimum, while with the further reduction of speed, their values increase. This is mainly due to the consideration of total ship power, including the main and the auxiliary engines, whereby greatly reducing the speed, required energy increases, as indicated in a study by Ritari et al. [139]. If only the power of the main engine was considered, the emission and costs would be reduced, and the power-speed function would not have its minimum.

After identifying the optimal combination of measures (i.e. fully electrification with a certain percentage of speed reduction) for selected ships, their *EEIs* are calculated and presented

in Figure 28 together with *EEIs* for diesel and electricity when they operate at average speed and design speed.

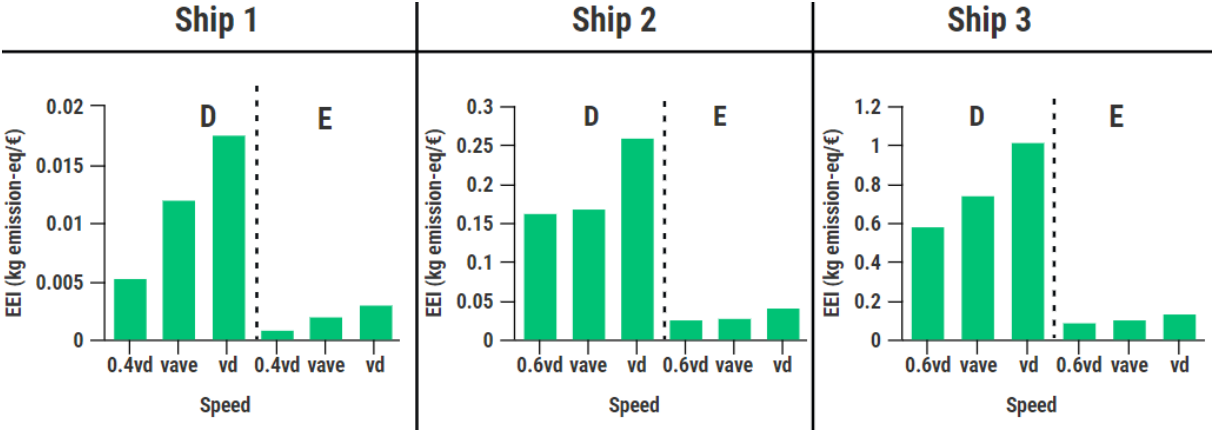

Figure 28. *EEIs* comparison of diesel-powered ships and electricity-powered ships operating at different speeds [106]

The results of *EEIs* comparison in Figure 28 indicate a greater reduction of *EEI* for electric Ship 1 than for electric Ship 2 and electric Ship 3, compared to their diesel power system configuration.

ARTICLE 8 satisfy one of the scientific contributions of the doctoral dissertation, as well confirm one hypothesis regarding the definition of the energy efficiency design index for short sea and inland waterway vessels, which includes multiple operating points and applies to power systems with alternative energy sources. Energy efficiency and environmental friendliness determined in this way do not represent the feature of the ship itself but indicate whether some technical solutions and the way the ship power system is exploited, are beneficial for the environment or not. It should be clear that the presented model that simultaneously considers ship energy efficiency and environmental friendliness should not be applied to compare ships from different shipping sectors (even if they are within the same type). Namely, this formulation takes into account fuel pathways and energy mix, which are specific to a certain location.

2.4. Design procedure of high energy efficiency power systems for ships

The above-presented research resulted in the development of the design procedure for the power systems of short-sea shipping and inland waterway vessels, which will have higher energy efficiency and lower overall costs than the existing solutions. Its general model is presented in Figure 29.

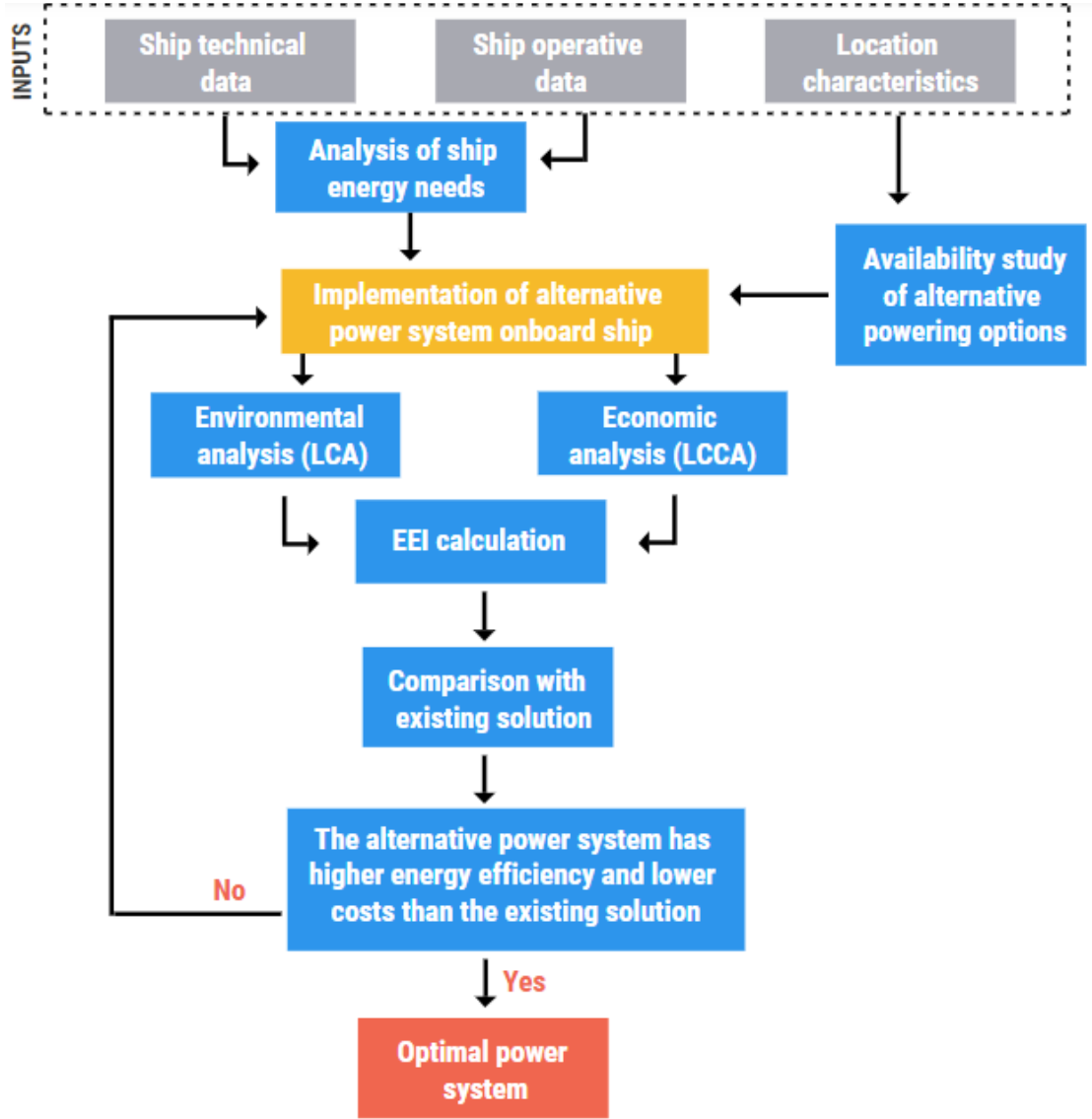

Figure 29. Design procedure for power systems of short-sea and inland waterway vessels, with higher energy efficiency levels and lower costs than the existing solutions

According to the presented procedure in Figure 29, the ship technical data and operational data represent inputs for the analysis of ship energy needs, while the location

characteristics of the area where a ship is operating (e.g. fuel production, electricity mix of the country, available distribution chains, etc.) are necessary for the availability study on alternative powering options. The following step of the procedure is the implementation of alternative power systems onboard the considered ship and its analyses from the environmental and economic points of view by performing LCA and LCCA. After the calculation of *EEI*, the ship powered by an alternative power system is compared with the existing power system onboard. The optimal power system is the one that satisfies the requirements of higher energy efficiency and lower costs than the existing solution. If the alternative power system does not satisfy these criteria, another alternative is investigated. However, if any of the considered alternative power systems do not comply the certain requirements, bi-objective optimization can be performed.

The scientific contribution, goal and hypothesis of this doctoral dissertation refer to the development of this design procedure, which can be applied to the ships engaged in the Croatian short-sea shipping and inland navigation fleet. Firstly, the analyses of the considered fleets performed in ARTICLE 1 and 4 resulted in the required inputs for the analysis of ship energy needs.

Bearing in mind the characteristics of the area of navigation, the availability study of alternative power systems is performed together with the investigation of the applicability of alternative power systems onboard the considered ships, as investigated within ARTICLE 2, 3, 4, 5 and 6. One of the scientific contributions and goals of this doctoral dissertation is the identification of a set of appropriate alternative powering options for the ships engaged in the Croatian short-sea shipping and inland navigation fleets. Based on the results of the technological, environmental and economic assessments presented in subsection 2.2., with the current energy market, the selected appropriate alternatives for both inland navigation and short-sea shipping fleets are full electrification with only a Li-ion battery and the application of dual-fuel engine powered by methanol and diesel. Both of them satisfy environmental and economic criteria. However, methanol as an alternative marine fuel is not yet ready to be used in Croatia since it requires the development of supply chains to Croatia as well as building up bunkering facilities in ports. The battery is familiar and commercially available technology. To the full electrification of the Croatian ships becomes a feasible alternative, fast chargers need to be installed in each port. Due to the short routes and fixed schedule, electrification is a feasible solution for the ro-ro passenger ship and passenger ships engaged in inland navigation. The first fully electrified ferry with a battery was the Norwegian Ampere in 2015 [140], which

opened the pathway toward electrification of the short-sea shipping sector. Currently, there are a lot of worldwide ferries and coastal vessels powered by only a battery [141]. The full electrification of ships is not yet applicable to ocean-going vessels, but in the future, with the further development of metal-air battery technology with a much higher energy density and lifetime than the Li-ion battery [142], it may be feasible. Moreover, methanol can be applied in short-sea shipping but also ocean-going vessels. Maersk announced the introduction of its first ocean-going container ships powered by carbon-neutral methanol in the first quarter of 2024. The ships will be equipped with a dual-fuel engine that can be powered by methanol and conventional low sulphur fuel [143].

The following step of the procedure was the calculation of *EEI* for different power systems in ARTICLE 8, which indicated that fully electrified ro-ro passenger ships represent the optimal power solution, and due to that, it was not necessary to perform optimisation.

3. Conclusions and future work

3.1. Conclusions of the doctoral dissertation

The emissions released due to the combustion of fossil fuels in marine engines negatively affect the environment and human health. This impact of shipping is more pronounced when the ships are navigating near populated areas and spend much time in ports, and in that way, directly impair the air quality of the local population. These ships are usually engaged in the short-sea shipping and inland navigation sector.

In this doctoral dissertation, the focus is put on the Croatian short-sea shipping and inland navigation fleet. The ships operating in the considered Croatian fleets are mostly outdated, powered by low energy-efficient diesel engines. The replacement of ships with new ones or the replacement of their power system with an alternative opens the pathways for the implementation of some innovative and greener technologies that will satisfy environmental regulations and reduce the direct negative impact on the local population. Due to the moderate energy requirements and the proximity to the shore, these ships represent appropriate test cases to investigate the applicability of new technologies in the shipping sector, such as the implementation of alternative fuels and electrification, which are also one of the aims of the Croatian Low-Carbon Development Strategy.

The replacements of diesel power system configuration with alternative powering options onboard the ships engaged in the Croatian short-sea shipping and inland waterway fleets were investigated within this research. The performed availability study and environmental and economic assessments highlighted full electrification with only a battery, as well as methanol in a dual-fuel engine, as the most feasible alternatives that satisfy environmental and economic criteria. Full electrification with a Li-ion battery was indicated as the most appropriate alternative solution onboard ships which operate on short routes and have fixed operating schedules. Moreover, the Li-ion battery is a well-known and available technology whose application as a ship powering option results in the absence of tailpipe emissions but also lowers the noise and vibrations. The methanol-powered ship also results in lower GHG emissions and costs. Although it has lower carbon content than diesel, methanol is still a fossil fuel whose combustion results in tailpipe emissions. Its use in Croatia requires a higher level of investment

(bunkering facilities in ports, development of supply chains, etc.) than for electricity-powered ships for whose feasibility the fast-chargers in ports need to be installed.

The alternative power systems implemented onboard the Croatian ro-ro passenger ships were also compared based on their energy efficiency and environmental friendliness. Since EEDI and EEXI are not applicable for the evaluation of the energy efficiency of ships powered by alternative power systems, within this doctoral dissertation, the *EEI* is formulated. It represents a mathematical model for simultaneous assessment of ship energy efficiency and environmental friendliness, which can be applied not only to diesel engine-powered ships but to a range of alternative powering options. The comparison of *EEI* through several operating points (different operative speeds) confirmed that electrification results in a lower *EEI* than other alternative options.

The final step in the research was the development of the design procedure for the power systems of short-sea shipping and inland waterway vessels, with higher energy efficiency and lower overall costs than the existing solutions. Although the research focuses on the case study of Croatia, the developed design procedure, formulated energy efficiency index applicable for alternative power systems, as well as environmental and economic assessment models, are generally applicable to other shipping sectors of other countries if a set of specific input data is available.

3.2. Guidelines for future work

The performed research resulted in the general models, whose applicability for the identification of optimal alternative options for the replacement of conventional power systems need to be tested on some other ro-ro passenger ships, that operate in other countries and have different energy mixes and energy markets. Furthermore, the developed models can be tested in the different shipping sectors, such as the fishing sector, in which different types of fishing vessels operate and catch fish in different ways, and they do not have a specific route of navigation. Due to that, their energy requirements are rather specific as well as the benefit for the society. The applicability analysis for the ocean-going vessels would be more complicated, not only because of the low competitiveness of some alternative options but also because of the need to combine fuel cycles and different fuel prices of several countries along the shipping

route. In addition, further analysis of determining weighting factors used within *EEI* formulation should also be performed since they differ depending on the area of application.

In this doctoral dissertation, the implementation of alternative powering options is investigated from the environmental and economic points of view, through their life-cycle emissions and lifetime costs. However, their use onboard also depends on their safety and reliability, whose analyses will be one of the subjects of further investigation.

4. Bibliography

- [1] Monteiro A, Russo M, Gama C, Borrego C. How important are maritime emissions for the air quality: At European and national scale. *Environmental Pollution*. 2018;242:565–75.
- [2] Sofiev M, Winebrake JJ, Johansson L, Carr EW, Prank M, Soares J, et al. Cleaner fuels for ships provide public health benefits with climate tradeoffs. *Nature Communications* 2018; 6;9(1):406.
- [3] Runko Luttenberger L, Ančić I, Šestan A. The viability of short-sea shipping in Croatia. *Brodogradnja*. 2013;64:472–81.
- [4] Gobbi GP, Di Liberto L, Barnaba F. Impact of port emissions on EU-regulated and non-regulated air quality indicators: The case of Civitavecchia (Italy). *Science of the Total Environment*. 2020;719:134984.
- [5] International Maritime Organization. Resolution MEPC. 203(62). 2011.
- [6] Ančić I, Theotokatos G, Vladimir N. Towards improving energy efficiency regulations of bulk carriers. *Ocean Engineering*. 2018 Jan 15;148:193–201.
- [7] Bouman EA, Lindstad E, Riialand AI, Strømman AH. State-of-the-art technologies, measures, and potential for reducing GHG emissions from shipping – A review. *Transportation Research Part D: Transport and Environment*. 2017;52:408–21.
- [8] Zhao J, Wei Q, Wang S, Ren X. Progress of ship exhaust gas control technology. *Science of The Total Environment*. 2021 Dec 10;799:149437.
- [9] Kim T, Chae C. Environmental Impact Analysis of Acidification and Eutrophication Due to Emissions from the Production of Concrete. *Sustainability*. 2016;8(6):578.
- [10] United Nations Framework Convention Climate Change. Climate Change Information kit. Available from: <https://unfccc.int/resource/iuckit/cckit2001en.pdf>; (accessed on April 20, 2022.)
- [11] Hildén M. The evolution of climate policies - The role of learning and evaluations. *Journal of Cleaner Production*. 2011;19(16):1798–811.
- [12] Bataille C, Åhman M, Neuhoff K, Nilsson LJ, Fishedick M, Lechtenböhmer S, et al. A review of technology and policy deep decarbonization pathway options for making

- energy-intensive industry production consistent with the Paris Agreement. *Journal of Cleaner Production*. 2018;187:960–73.
- [13] United Nations Framework Convention Climate Change. The Glasgow Climate Pact [cited 2022 Apr 5]. Available from: <https://unfccc.int/process-and-meetings/the-paris-agreement/the-glasgow-climate-pact-key-outcomes-from-cop26>; (accessed on April 5, 2022)
- [14] Dwivedi YK, Hughes L, Kar AK, Baabdullah AM, Grover P, Abbas R, et al. Climate change and COP26: Are digital technologies and information management part of the problem or the solution? An editorial reflection and call to action. *International Journal of Information Management*. 2022;63:102456.
- [15] Chu Van T, Ramirez J, Rainey T, Ristovski Z, Brown RJ. Global impacts of recent IMO regulations on marine fuel oil refining processes and ship emissions. *Transportation Research Part D: Transport and Environment*]. 2019;70:123–34.
- [16] International Maritime Organization. Prevention of Air Pollution from Ships. Available from: <https://www.imo.org/en/OurWork/Environment/Pages/Air-Pollution.aspx>; (accessed on April 5, 2022).
- [17] Emission Standards: IMO Marine Engine Regulations. Available from: <https://dieselnet.com/standards/inter/imo.php#s>; (accessed 05.03.2022).
- [18] Chen L, Yip TL, Mou J. Provision of Emission Control Area and the impact on shipping route choice and ship emissions. *Transportation Research Part D: Transport and Environment*. 2018;58:280–91.
- [19] International Maritime Organization. NOX regulations. Available from: [https://www.imo.org/en/OurWork/Environment/Pages/Nitrogen-oxides-\(NOx\)-Regulation-13.aspx](https://www.imo.org/en/OurWork/Environment/Pages/Nitrogen-oxides-(NOx)-Regulation-13.aspx); (accessed on March 15, 2022).
- [20] IMO 2020 – cutting sulphur oxide emissions. Available from: [https://www.imo.org/en/MediaCentre/HotTopics/Pages/Sulphur-2020.aspx#:~:text=Known%20as%20%E2%80%9CIMO%202020%E2%80%9D%2C,were%20already%20stricter%20\(0.10%25\).](https://www.imo.org/en/MediaCentre/HotTopics/Pages/Sulphur-2020.aspx#:~:text=Known%20as%20%E2%80%9CIMO%202020%E2%80%9D%2C,were%20already%20stricter%20(0.10%25).); (accessed on April 20, 2022).
- [21] Regional Marine Pollution Emergency Response Centre for the Mediterranean Sea. Med SOx ECA. Available from: <https://www.rempec.org/en/our-work/pollution-prevention/hop-topics/med-eca/med-sox-eca-introduction>; (accessed March 28, 2022).

- [22] Offshore Energy. Marseille Fos - the Mediterranean's 1st Fully Electric Port by 2025. Available from: <https://www.offshore-energy.biz/marseille-fos-wants-to-be-mediterraneans-1st-fully-electric-port-by-2025/>; (accessed on April 15, 2022).
- [23] Ančić I, Vladimir N, Runko Luttenberger L. Energy efficiency of ro-ro passenger ships with integrated power systems. *Ocean Engineering*. 2018;166:350–7.
- [24] Traut M, Larkin A, Anderson K, McGlade C, Sharmina M, Smith T. CO₂ abatement goals for international shipping. *Climate Policy*. 2018;18(8):1066–75.
- [25] Lindstad E, Borgen H, Eskeland GS, Paalson C, Psaraftis H, Turan O. The Need to Amend IMO's EEDI to Include a Threshold for Performance in Waves (Realistic Sea Conditions) to Achieve the Desired GHG Reductions. *Sustainability*. 2019;11(13):3668.
- [26] Ančić I, Vladimir N, Cho DS. Determining environmental pollution from ships using Index of Energy Efficiency and Environmental Eligibility (I4E). *Marine Policy*. 2018;95:1–7.
- [27] Trivyza NL, Rentizelas A, Theotokatos G. A Comparative Analysis of EEDI Versus Lifetime CO₂ Emissions. *Journal of Marine Science and Engineering*. 2020;8(1):61.
- [28] Resolution MEPC.334(76) - Annex 8. Guidelines on survey and certification of the attained energy efficiency existing ship index (EEXI).
- [29] DNV. Energy Efficiency Existing Ship Index (EEXI). Available from: <https://www.dnv.com/maritime/insights/topics/eexi/index.html>; (accessed March 10, 2022).
- [30] DNV. Carbon Intensity Indicator. Available from: <https://www.dnv.com/maritime/insights/topics/CII-carbon-intensity-indicator/index.html>; (accessed March 18, 2022).
- [31] Wiedmann T, Minx J. A Definition of “Carbon Footprint.” In: *Ecological Economics Research Trends*. 2008. p. 1–11.
- [32] Blanco-Davis E, Zhou P. LCA as a tool to aid in the selection of retrofitting alternatives. *Ocean Engineering*. 2014;77:33–41.
- [33] Ling-Chin J, Heidrich O, Roskilly AP. Life cycle assessment (LCA) – from analysing methodology development to introducing an LCA framework for marine photovoltaic (PV) systems. *Renewable and Sustainable Energy Reviews*. 2016;59:352–78.
- [34] International Maritime Organization (IMO). Fourth IMO GHG study-Final report, 2020. Available from: <https://safety4sea.com/wp-content/uploads/2020/08/MEPC-75->

- [7-15-Fourth-IMO-GHG-Study-2020-Final-report-Secretariat.pdf](#); (accessed January 14, 2022).
- [35] Xing H, Spence S, Chen H. A comprehensive review on countermeasures for CO₂ emissions from ships. *Renewable and Sustainable Energy Reviews*. 2020;134:110222.
- [36] Ančić I, Perčić M, Vladimir N. Alternative power options to reduce carbon footprint of ro-ro passenger fleet: A case study of Croatia. *Journal of Cleaner Production*. 2020;271:122638.
- [37] Ait Allal A, Mansouri K, Youssfi M, Qbadou M. Toward an evaluation of marine fuels for a clean and efficient autonomous ship propulsion energy. In: *Materials Today: Proceedings*. Elsevier Ltd; 2019. 486–95.
- [38] Hansson J, Månsson S, Brynolf S, Grahn M. Alternative marine fuels: Prospects based on multi-criteria decision analysis involving Swedish stakeholders. *Biomass and Bioenergy*. 2019;126:159–73.
- [39] Al-Enazi A, Okonkwo EC, Bicer Y, Al-Ansari T. A review of cleaner alternative fuels for maritime transportation. *Energy Reports*. 2021;7:1962–85.
- [40] Xing H, Stuart C, Spence S, Chen H. Alternative fuel options for low carbon maritime transportation: Pathways to 2050. *Journal of Cleaner Production*. 2021;297:126651.
- [41] Foretich A, Zaimes GG, Hawkins TR, Newes E. Challenges and opportunities for alternative fuels in the maritime sector. *Maritime Transport Research*. 2021;2:100033.
- [42] DNV. Uptake of alternative fuels for the world fleet as of June 2021 including ships in operation and on order. Available from: <https://www.dnv.com/maritime/hub/decarbonize-shipping/fuels/bridging-fuels.html>; (accessed on April 10, 2022).
- [43] Livanos GA, Theotokatos G, Pagonis DN. Techno-economic investigation of alternative propulsion plants for Ferries and RoRo ships. *Energy Conversion and Management*. 2014;79:640–51.
- [44] Schinas O, Butler M. Feasibility and commercial considerations of LNG-fueled ships. *Ocean Engineering*. 2016;122:84–96.
- [45] Sharafian A, Blomerus P, Mérida W. Natural gas as a ship fuel: Assessment of greenhouse gas and air pollutant reduction potential. *Energy Policy*. 2019;131:332–46.
- [46] Fan A, Wang J, He Y, Perčić M, Vladimir N, Yang L. Decarbonising inland ship power system: Alternative solution and assessment method. *Energy*. 2021;226:120266.

- [47] Jafarzadeh S, Schjøberg I. Operational profiles of ships in Norwegian waters: An activity-based approach to assess the benefits of hybrid and electric propulsion. *Transportation Research Part D: Transport and Environment*. 2018;65:500–23.
- [48] Ammar NR. An environmental and economic analysis of methanol fuel for a cellular container ship. *Transportation Research Part D: Transport and Environment*. 2019;69:66–76.
- [49] Worlds First Methanol Ship-Stena Germanica. Available from: <https://safety4sea.com/worlds-first-methanol-ship-announced-stena-line/>; (accessed on April 22, 2022).
- [50] MAN Energy Solutions. The ME-LGI Engine and Methanol as a Marine Fuel, 2020. [cited 2021 May 26]. Available from: <https://marine.man-es.com/two-stroke/2-stroke-engines/me-lgim>; (accessed on September 25, 2021).
- [51] International Maritime Organization. Methanol as marine fuel: Environmental benefits, technology readiness, and economic feasibility. 2016.
- [52] Hammond GP, Seth SM. Carbon and environmental footprinting of global biofuel production. *Applied Energy* [Internet]. 2013;112:547–59.
- [53] Svanberg M, Ellis J, Lundgren J, Landälv I. Renewable methanol as a fuel for the shipping industry. *Renewable and Sustainable Energy Reviews*. 2018;94:1217–28.
- [54] Matzen M, Alhajji M, Demirel Y. Chemical storage of wind energy by renewable methanol production: Feasibility analysis using a multi-criteria decision matrix. *Energy*. 2015;93:343–53.
- [55] Helgason R, Cook D, Davíðsdóttir B. An evaluation of the cost-competitiveness of maritime fuels – a comparison of heavy fuel oil and methanol (renewable and natural gas) in Iceland. *Sustainable Production and Consumption*. 2020;23:236–48.
- [56] Matzen M, Demirel Y. Methanol and dimethyl ether from renewable hydrogen and carbon dioxide: Alternative fuels production and life-cycle assessment. *Journal of Cleaner Production*. 2016;139:1068–77.
- [57] Sterling PlanB Energy Solutions (SPBES). Electrification of ships. Available from: <https://spb.es.com/>; (accessed on January 13,2021).
- [58] Gagatsi E, Estrup T, Halatsis A. Exploring the Potentials of Electrical Waterborne Transport in Europe: The E-ferry Concept. In: *Transportation Research Procedia*. Elsevier B.V.; 2016:1571–80.

- [59] Nuchturee C, Li T, Xia H. Energy efficiency of integrated electric propulsion for ships – A review. *Renewable and Sustainable Energy Reviews* 2020;134:110145.
- [60] Lindstad HE, Eskeland GS, Riialand A. Batteries in offshore support vessels – Pollution, climate impact and economics. *Transportation Research Part D: Transport and Environment*. 2017;50:409–17.
- [61] Geertsma RD, Negenborn RR, Visser K, Hopman JJ. Design and control of hybrid power and propulsion systems for smart ships: A review of developments. *Applied Energy*. 2017;194:30–54.
- [62] Welaya YMA, El Gohary MM, Ammar NR. A comparison between fuel cells and other alternatives for marine electric power generation. *International Journal of Naval Architecture and Ocean Engineering*. 2011;3(2):141–9.
- [63] Ma S, Lin M, Lin T-E, Lan T, Liao X, Maréchal F, et al. Fuel cell-battery hybrid systems for mobility and off-grid applications: A review. *Renewable and Sustainable Energy Reviews*. 2021;135:110119.
- [64] Sundén B. Fuel cell types - overview. In: *Hydrogen, Batteries and Fuel Cells*. Elsevier; 2019. 123–44.
- [65] de-Troya JJ, Álvarez C, Fernández-Garrido C, Carral L. Analysing the possibilities of using fuel cells in ships. *International Journal of Hydrogen Energy*. 2016;41(4):2853–66.
- [66] Inal OB, Deniz C. Assessment of fuel cell types for ships: Based on multi-criteria decision analysis. *Journal of Cleaner Production*. 2020;265:121734.
- [67] van Biert L, Godjevac M, Visser K, Aravind PV. A review of fuel cell systems for maritime applications. *Journal of Power Sources*. 2016;327:345–64.
- [68] Sapra H, Stam J, Reurings J, van Biert L, van Sluijs W, de Vos P, et al. Integration of solid oxide fuel cell and internal combustion engine for maritime applications. *Applied Energy*. 2021;281:115854.
- [69] Ahn J, Park SH, Noh Y, Choi B Il, Ryu J, Chang D, et al. Performance and availability of a marine generator-solid oxide fuel cell-gas turbine hybrid system in a very large ethane carrier. *Journal of Power Sources*. 2018;399:199–206.
- [70] Wu P, Bucknall R. Hybrid fuel cell and battery propulsion system modelling and multi-objective optimisation for a coastal ferry. *International Journal of Hydrogen Energy*. 2020;45(4):3193–208.

- [71] Choi CH, Yu S, Han I-S, Kho B-K, Kang D-G, Lee HY, et al. Development and demonstration of PEM fuel-cell-battery hybrid system for propulsion of tourist boat. *International Journal of Hydrogen Energy*. 2016;41(5):3591–9.
- [72] Bilgili L. Comparative assessment of alternative marine fuels in life cycle perspective. *Renewable and Sustainable Energy Reviews*. 2021;144:110985.
- [73] Korberg AD, Brynolf S, Grahn M, Skov IR. Techno-economic assessment of advanced fuels and propulsion systems in future fossil-free ships. *Renewable and Sustainable Energy Reviews*. 2021;142:110861.
- [74] Prussi M, N S, Acciaro M, V K. Potential and limiting factors in the use of alternative fuels in the European maritime sector. *Journal of Cleaner Production*. 2021;125849.
- [75] Nair A, Acciaro M. Alternative fuels for shipping : optimising fleet composition under environmental and economic constraints. *International Journal of Transport Economics*. 2018;XLV.
- [76] Lagemann B, Lindstad E, Fagerholt K, Riialand A, Ove Erikstad S. Optimal ship lifetime fuel and power system selection. *Transportation Research Part D: Transport and Environment*. 2022;102:103145.
- [77] Perčić M, Frković L, Pukšec T, Čosić B, Li OL, Vladimir N. Life-cycle assessment and life-cycle cost assessment of power batteries for all-electric vessels for short-sea navigation. *Energy*. 2022;251:123895.
- [78] Wang H, Boulougouris E, Theotokatos G, Zhou P, Priftis A, Shi G. Life cycle analysis and cost assessment of a battery powered ferry. *Ocean Engineering*. 2021;241:110029.
- [79] Kjær LL, Pagoropoulos A, Hauschild M, Birkved M, Schmidt JH, McAloone TC. From LCC to LCA Using a Hybrid Input Output Model – A Maritime Case Study. *Procedia CIRP*. 2015 Jan 1;29:474–9.
- [80] Brynolf S, Fridell E, Andersson K. Environmental assessment of marine fuels: Liquefied natural gas, liquefied biogas, methanol and bio-methanol. *Journal of Cleaner Production*. 2014;74:86–95.
- [81] Gilbert P, Walsh C, Traut M, Kesieme U, Pazouki K, Murphy A. Assessment of full life-cycle air emissions of alternative shipping fuels. *Journal of Cleaner Production*. 2018;172:855–66.
- [82] Deniz C, Zincir B. Environmental and economical assessment of alternative marine fuels. *Journal of Cleaner Production*. 2016;113:438–49.

- [83] Yu W, Zhou P, Wang H. Evaluation on the energy efficiency and emissions reduction of a short-route hybrid sightseeing ship. *Ocean Engineering*. 2018;162:34–42.
- [84] Yuan Y, Wang J, Yan X, Li Q, Long T. A design and experimental investigation of a large-scale solar energy/diesel generator powered hybrid ship. *Energy*. 2018;165:965–78.
- [85] Ghenai C, Bettayeb M, Brdjanin B, Hamid AK. Hybrid solar PV/PEM fuel Cell/Diesel Generator power system for cruise ship: A case study in Stockholm, Sweden. *Case Studies in Thermal Engineering*. 2019;14:100497.
- [86] Wan Z, el Makhloufi A, Chen Y, Tang J. Decarbonizing the international shipping industry: Solutions and policy recommendations. *Marine Pollution Bulletin*. 2018;126:428–35.
- [87] Armstrong VN. Vessel optimisation for low carbon shipping. *Ocean Engineering*. 2013;73:195–207.
- [88] Degiuli N, Martić I, Farkas A, Gospić I. The impact of slow steaming on reducing CO2 emissions in the Mediterranean Sea. *Energy Reports*. 2021;7:8131–41.
- [89] Woo J-K, Moon DS-H. The effects of slow steaming on the environmental performance in liner shipping. *Maritime Policy & Management*. 2014;41(2):176–91.
- [90] DNV. Achieving the IMO decarbonization goals. Available from: <https://www.dnv.com/expert-story/maritime-impact/How-newbuilds-can-comply-with-IMOs-2030-CO2-reduction-targets.html>; (accessed on October 15, 2021).
- [91] Trivyza NL, Rentizelas A, Theotokatos G. Impact of carbon pricing on the cruise ship energy systems optimal configuration. *Energy*. 2019;175:952–66.
- [92] Psaraftis HN, Zis T, Lagouvardou S. A comparative evaluation of market based measures for shipping decarbonization. *Maritime Transport Research*. 2021;2:100019.
- [93] Lindstad E, Lagemann B, Riialand A, Gamlem GM, Valland A. Reduction of maritime GHG emissions and the potential role of E-fuels. *Transportation Research Part D: Transport and Environment*. 2021;101:103075.
- [94] Inal OB, Charpentier JF, Deniz C. Hybrid power and propulsion systems for ships: Current status and future challenges. *Renewable and Sustainable Energy Reviews*. 2022;156:111965.
- [95] Keuken MP, Moerman M, Jonkers J, Hulskotte J, Denier van der Gon HAC, Hoek G, et al. Impact of inland shipping emissions on elemental carbon concentrations near

- waterways in The Netherlands. Vol. 95, Atmospheric Environment. Elsevier Ltd; 2014: 1–9.
- [96] Arof AM. Decision Making Model for Ro-Ro Short Sea Shipping Operations in Archipelagic Southeast Asia. *Asian Journal of Shipping and Logistics*. 2018;34(1):33–42.
- [97] Wiegmans B, Witte P, Spit T. Inland port performance: A statistical analysis of Dutch inland ports. In: *Transportation Research Procedia*. Elsevier; 2015:145–54.
- [98] Sun X, Yan X, Wu B, Song X. Analysis of the operational energy efficiency for inland river ships. *Transportation Research Part D: Transport and Environment*. 2013;22:34–9.
- [99] Argonne GREET Model. Available from: <https://greet.es.anl.gov/>; (accessed on January 10, 2022).
- [100] Perčić M, Vladimir N, Koričan M. Electrification of Inland Waterway Ships Considering Power System Lifetime Emissions and Costs. *Energies*. 2021;14(21):7046.
- [101] Perčić M, Ančić I, Vladimir N. Life-cycle cost assessments of different power system configurations to reduce the carbon footprint in the Croatian short-sea shipping sector. *Renewable and Sustainable Energy Reviews*. 2020;131:110028.
- [102] Perčić M, Vladimir N, Fan A. Life-cycle cost assessment of alternative marine fuels to reduce the carbon footprint in short-sea shipping: A case study of Croatia. *Applied Energy*. 2020;279:115848.
- [103] Perčić M, Vladimir N, Jovanović I, Koričan M. Application of fuel cells with zero-carbon fuels in short-sea shipping. *Applied Energy*. 2022;309:118463.
- [104] Perčić M, Vladimir N, Fan A. Techno-economic assessment of alternative marine fuels for inland shipping in Croatia. *Renewable and Sustainable Energy Reviews*. 2021;148:111363.
- [105] Vladimir N, Bakica A, Perčić M, Jovanović I. Modular Approach in the Design of Small Passenger Vessels for Mediterranean. *Journal of Marine Science and Engineering*. 2022;10(1):117.
- [106] Perčić M, Vladimir N, Fan A, Jovanović I. Holistic energy efficiency and environmental friendliness model for short-sea vessels with alternative power systems considering realistic fuel pathways and workloads. *Journal of Marine Science and Engineering* 2022;10(5):613.

- [107] International Energy Agency. Croatia. Available from: <https://www.iea.org/countries/croatia>; (accessed on April 19, 2022).
- [108] European Commission. A European Strategy for low-emission mobility. Available from: https://ec.europa.eu/clima/policies/transport_en; (accessed on April 10, 2022).
- [109] Ministry of Economy and Sustainable Development. Croatian greenhouse gas inventory for the period 1990 - 2019 (National Inventory Report 2021), 2021. Available from: http://www.haop.hr/sites/default/files/uploads/dokumenti/012_klima/dostava_podataka/Izvjesca/Croatian NIR 2021_0.pdf; (accessed on April 13, 2022).
- [110] Ministry of Economy and Sustainable Development of Republic of Croatia. Low-Carbon Development Strategy of the Republic of Croatia until 2030 with an outlook to 2050. Available from: <https://mingor.gov.hr/o-ministarstvu-1065/djelokrug-4925/klima/strategije-planovi-i-programi-1915/strategija-niskouglijcnog-razvoja-hrvatske/1930>; (accessed on April 15, 2022).
- [111] INA. Motor fuels. Available from: <https://www.ina.hr/en/home/customers/products-and-services/motor-fuels/>; (accessed on December 10, 2022).
- [112] Climatescope. Croatia, 2021. Available from: <https://global-climatescope.org/markets/hr/>; (accessed on April 10, 2022).
- [113] European Commission. Clean energy for EU islands. Available from: <https://clean-energy-islands.ec.europa.eu/countries/croatia>; (accessed on July 14, 2022):
- [114] Torbianelli VA. When the road controls the sea: a case study of Ro-Ro transport in the Mediterranean. *Maritime Policy & Management*. 2000;27(4):375–89.
- [115] Croatian short-sea shipping routes. Available from: <https://www.croatiaferries.com/island-hopping-croatia/>; (accessed on April 14, 2022).
- [116] Ministry of Sea Transport and Infrastructure of the Republic of Croatia. Inland navigation. Available from: <https://mmpi.gov.hr/more-86/unutarnja-plovidba-110/110>; (accessed on March 10, 2022).
- [117] Croatian Register of Shipping. Register of inland waterway vessels. Available from: http://www.crs.hr/Portals/0/CRS_Knjiga_Registra_2017.pdf?ver=2018-07-04-155704-933; (accessed on April 15, 2021).
- [118] Strazza C, Del Borghi A, Costamagna P, Traverso A, Santin M. Comparative LCA of methanol-fuelled SOFCs as auxiliary power systems on-board ships. *Applied Energy*. 2010;87(5):1670–8.

- [119] EU Emissions Trading System (EU ETS). Available from: https://ec.europa.eu/clima/policies/ets_en; (accessed on April 10, 2022).
- [120] European Commission. Reducing emissions from the shipping sector. Available from: https://ec.europa.eu/clima/eu-action/transport-emissions/reducing-emissions-shipping-sector_en; (accessed on July 15, 2022).
- [121] World Energy Outlook 2019. OECD; 2019.
- [122] EU Carbon Permits (2021 Data). Available from: <https://tradingeconomics.com/commodity/carbon>; (accessed on April 18, 2022).
- [123] Hwang SS, Gil SJ, Lee GN, Lee JW, Park H, Jung KH, et al. Life Cycle Assessment of Alternative Ship Fuels for Coastal Ferry Operating in Republic of Korea. *Journal of Marine Science and Engineering* [Internet]. 2020;8(9):660. 121.
- [124] Letafat A, Rafiei M, Sheikh M, Afshari-Igder M, Banaei M, Boudjadar J, et al. Simultaneous energy management and optimal components sizing of a zero-emission ferry boat. *Journal of Energy Storage*. 2020;28:101215.
- [125] Balestra L, Schjølborg I. Energy management strategies for a zero-emission hybrid domestic ferry. *International Journal of Hydrogen Energy*. 2021;46(77):38490–503.
- [126] Dierickx J, Verbiest J, Janvier T, Peeters J, Sileghem L, Verhelst S. Retrofitting a high-speed marine engine to dual-fuel methanol-diesel operation: A comparison of multiple and single point methanol port injection. *Fuel Communications*. 2021;7:100010.
- [127] Dawood F, Anda M, Shafiullah GM. Hydrogen production for energy: An overview. *International Journal of Hydrogen Energy*. 2020;45(7):3847–69.
- [128] Ashrafi M, Lister J, Gillen D. Toward a harmonization of sustainability criteria for alternative marine fuels. *Maritime Transport Research*. 2022;3:100052.
- [129] Pei P, Chen H. Main factors affecting the lifetime of Proton Exchange Membrane fuel cells in vehicle applications: A review. *Applied Energy*. 2014;125:60–75.
- [130] Fasihi M, Weiss R, Savolainen J, Breyer C. Global potential of green ammonia based on hybrid PV-wind power plants. *Applied Energy*. 2021;294:116170.
- [131] Arnaiz del Pozo C, Cloete S. Techno-economic assessment of blue and green ammonia as energy carriers in a low-carbon future. *Energy Conversion and Management*. 2022;255:115312.
- [132] Bonacina CN, Gaskare NB, Valenti G. Assessment of offshore liquid hydrogen production from wind power for ship refueling. *International Journal of Hydrogen Energy*. 2022;47(2):1279–91.

- [133] Atilhan S, Park S, El-Halwagi MM, Atilhan M, Moore M, Nielsen RB. Green hydrogen as an alternative fuel for the shipping industry. *Current Opinion in Chemical Engineering*. 2021;31:100668.
- [134] Fernández-Ríos A, Santos G, Pinedo J, Santos E, Ruiz-Salmón I, Laso J, et al. Environmental sustainability of alternative marine propulsion technologies powered by hydrogen - a life cycle assessment approach. *Science of The Total Environment*. 2022;820:153189.
- [135] Kim K, Roh G, Kim W, Chun K. A Preliminary Study on an Alternative Ship Propulsion System Fueled by Ammonia: Environmental and Economic Assessments. *Journal of Marine Science and Engineering*. 2020;8(3):183.
- [136] Sala S, Cerutti AK, Pant R. Development of a weighting approach for the environmental footprint. European Commission – JRC technical report . Available from: https://ec.europa.eu/environment/eussd/smgp/documents/2018_JRC_Weighting_EF.pdf; (accessed on July 14, 2022).
- [137] Environmental Protection Agency. Understanding Global Warming Potentials. Available from: <https://www.epa.gov/ghgemissions/understanding-global-warming-potentials>; (accessed on May 26, 2021).
- [138] Gonçalves Castro M, Mestemaker B, Van Den Heuvel H. Towards zero emission work vessels: the case of a dredging vessel. In: *Proceedings of 2nd International Conference on Modelling and Optimisation of Ship Energy Systems (MOSES2019)*. Glasgow, Scotland, United Kingdom; 2019.
- [139] Ritari A, Spoof-Tuomi K, Huotari J, Niemi S, Tammi K. Emission Abatement Technology Selection, Routing and Speed Optimization of Hybrid Ships. *Journal of Marine Science and Engineering*. 2021;9(9):944.
- [140] Ship Technology. Ampere Electric-Powered Ferry. Available from: <https://www.ship-technology.com/projects/norled-zero-cat-electric-powered-ferry/>; (accessed on June 15, 2021).
- [141] Anwar S, Zia MYI, Rashid M, Rubens GZ de, Enevoldsen P. Towards Ferry Electrification in the Maritime Sector. *Energies*. 2020;13(24):6506.
- [142] Wang L, Hu J, Yu Y, Huang K, Hu Y. Lithium-air, lithium-sulfur, and sodium-ion, which secondary battery category is more environmentally friendly and promising based on footprint family indicators? *Journal of Cleaner Production*. 2020;276:124244.

[143] Maersk. A.P. Moller - Maersk accelerates fleet decarbonisation with 8 large ocean-going vessels to operate on carbon neutral methanol. Available from: <https://www.maersk.com/news/articles/2021/08/24/maersk-accelerates-fleet-decarbonisation>; (accessed on April 18, 2022).

5. Curriculum vitae

Maja Perčić was born on the 28th of October 1993 in Pula, Croatia, where she finished grammar school in 2012. In the same year, she started the undergraduate programme in Chemical Engineering at the Faculty of Chemical Engineering and Technology, University of Zagreb. She completed her studies in 2015, and in the same year, she enrolled in the graduate study programme of Chemical Engineering, which she finished in 2017. Since October 2018 she works as a Research Assistant on the project Green Modular Passenger Vessel for Mediterranean (GRiMM), at the Chair of Marine Engineering of the Faculty of Mechanical Engineering and Naval Architecture, University of Zagreb. The same year she started her PhD studies in the field of Naval Architecture and Ocean Engineering. During PhD studies, she received the Outstanding Doctoral Student Award in 2020 of the doctoral programme Mechanical Engineering, Naval Architecture, Aeronautical Engineering, Metallurgical Engineering, and the Annual award to young scientists and artists in 2021 granted by the Society of University Teachers, Scholars and Other Scientists in Zagreb. Her research interests include energy efficiency of ship power systems, alternative marine fuels, ship environmental friendliness, development and application of LCA and LCCA models, etc.

6. List of publications

Journal papers:

- Perčić, M.; Vladimir, N.; Fan, A.; Jovanović, I. Holistic energy efficiency and environmental friendliness model for short-sea vessels with alternative power systems considering realistic fuel pathways and workloads. *Journal of Marine Science and Engineering* 2022, 10(5): 613.
- Perčić, M.; Frković, L.; Pukšec, T.; Čosić, B.; Li, O.L.; Vladimir, N. Life-cycle assessment and life-cycle cost assessment of power batteries for all-electric vessels for short-sea navigation. *Energy* 2022, 251: 123895.
- Perčić, M.; Vladimir, N.; Jovanović, I.; Koričan, M.; Bakica, A. Advanced technical solutions for marine pollution control in the Adriatic Sea. *Rad Croatian Academy of Sciences and Arts, Technical Sciences* 2020, 549 (21), 1-30.
- Jovanović, I.; Vladimir, N.; Perčić, M.; Koričan, M. The feasibility of autonomous low-emission ro-ro passenger shipping in the Adriatic Sea. *Ocean Engineering* 2022, 247: 110712.
- Vladimir, N.; Bakica, A.; Perčić, M.; Jovanović, M. Modular approach in the design of small passenger vessels for Mediterranean. *Journal of Marine Science and Engineering*, 2022, 10 (1): 117.
- Perčić, M.; Vladimir, N.; Jovanović, I.; Koričan, M. Application of fuel cells with zero-carbon fuels in short-sea shipping. *Applied Energy* 2022, 309: 118463.
- Koričan, M.; Perčić, M.; Vladimir, N.; Soldo, V.; Jovanović, I. Environmental and economic assessment of mariculture systems using a high share of renewable energy sources. *Journal of Cleaner Production* 2022, 333: 130072.
- Perčić, M.; Vladimir, N.; Koričan, M. Electrification of inland waterway ships considering power system lifetime emissions and costs. *Energies* 2021, 14: 7046.
- Perčić, M.; Vladimir, N.; Fan, A. Techno-economic assessment of alternative marine fuels for inland shipping in Croatia. *Renewable and Sustainable Energy Reviews* 2021, 148: 111363.

- Fan, A.; Wang, J.; He, Y.; Perčić, M.; Vladimir, N.; Yang, L.: Decarbonising inland ship power system: Alternative solution and assessment method. *Energy* 2021, 226: 120266.
- Perčić, M.; Vladimir, N.; Fan, A. Life-cycle cost assessment of alternative marine fuels to reduce the carbon footprint in short-sea shipping: A case study of Croatia. *Applied Energy* 2020, 279: 115848.
- Ančić, I.; Perčić, M.; Vladimir, N. Alternative power options to reduce carbon footprint of ro-ro passenger fleet: A case study of Croatia. *Journal of Cleaner Production* 2020, 271: 122638.
- Perčić, M.; Ančić, I.; Vladimir, N. Life-cycle cost assessments of different power system configurations to reduce the carbon footprint in the Croatian short-sea shipping sector. *Renewable and Sustainable Energy Reviews* 2020, 131: 110028.
- Perčić, M.; Ančić, I.; Vladimir, N.; Runko Luttenberger, L. Comparative life cycle assessment of battery- and diesel engine-driven ro-ro passenger vessel. *Journal of Maritime & Transportation Sciences, Special Issue* 2020, 343-357.

Conference papers:

- Vladimir, N.; Koričan, M.; Perčić, M.; Alujević, N.; Hadžić, N. Analysis of the environmental footprint of a fishing trawler with overview of emission reduction technologies. *Proceedings of the 13th International Conference on Applied Energy (ICAE2021)*, Bangkok, Thailand, 24 (Part VII), 2021, 0387, 6.
- Perčić, M.; Vladimir, N.; Jovanović, I.; Koričan, M. Holistic environmental analysis of selected zero-emission powering options for ro-ro passenger ships in Croatia. *Proceedings of the 14th Annual Baška GNSS Conference: Technologies, Techniques and Applications Across PNT and The 1st Workshop on Smart, Blue and Green Maritime Technologies*, Baška, Croatia, 2021, 115-127.
- Jovanović, I.; Vladimir, N.; Perčić, M.; Koričan, M. A study into the economic viability of autonomous container shipping: Case study of a 9,400 TEU container vessel. *Proceedings of the 2nd International Congress on Ship and Marine Technology "Green and Intelligent Maritime Industry"*, Istanbul, Turska, 2021, 427-438.

- Perčić, M.; Vladimir, N.; Jovanović, I.; Koričan, M. Environmental analysis of methanol as an alternative marine fuel. *Proceedings of the 2nd International Congress on Ship and Marine Technology “Green and Intelligent Maritime Industry*, Istanbul, Turska, 2021, 167-176.
- Perčić, M.; Ančić, I.; Vladimir, N.; Fan, A.; He, Y. Comparative life cycle assessment of battery- and diesel engine-powered river cruise ship. *Proceedings of the 5th International Conference on Maritime Technology and Engineering MARTECH 2020*, Lisabon, Portugal, 2021, 415-421.
- Vladimir, N.; Perčić, M.; Jovanović, I.; Koričan, M. Environmental and economic analysis of alternative powering options for coastal vessels with respect to future emission reduction targets. *Proceedings of the III International Scientific Conference Sustainable and Efficient Use of Energy, Water and Natural Resources*, Saint Petersburg, Russia, 2021, 208-209.
- Koričan, M.; Perčić, M.; Vladimir, N.; Soldo, V. Integration of renewable energy sources into the aquaculture systems considering environmental and economic aspects. *Proceedings of the 12th International Conference on Applied Energy (ICAE2020) - Part 3*, Bangkok, Thailand, 2020, 406, 6.
- Perčić, M.; Vladimir, N.; Fan, A.; He, Y. Reduction of CO₂ emissions of inland passenger and cargo vessels by alternative power system configurations. *Proceedings of the 12th International Conference on Applied Energy (ICAE2020) - Part 3*, Bangkok, Thailand, 2020, 453, 6.
- Perčić, M.; Vladimir, N.; Fan, A.; Koričan, M.; & Jovanović, I. (2020) Towards environmentally friendly short-sea transportation via integration of renewable energy sources in the ship power systems. *Proceedings of the Applied Energy Symposium: Low carbon cities and urban energy systems (CUE2020) - Part 2*, Tokyo, Japan, 2020, D-171, 6.
- Ančić, I., Perčić, M.; Vladimir, N. Effect of new energy efficiency regulations on practical design of selected ship types. *Proceedings of the 14th International Symposium on Practical Design of Ships and other Floating Structures PRADS'19*, Yokohama, Japan, 2019, 1-13.
- Ančić, I.; Perčić, M.; Theotokatos, G.; Vladimir, N. A novel approach towards more realistic energy efficiency regulations for tankers. *Proceedings of the 2nd International*

Conference on Modelling and Optimisation of Ship Energy Systems (MOSES 2019), Glasgow, Scotland, UK, University of Strathclyde, 2019, 183-188.

- Ančić, I.; Perčić, M.; Runko Luttenberger, L.; Vladimir, N. Potential to reduce environmental pollution from ships through the modular concept approach. *Proceedings of the 8th International Maritime Science Conference (IMSC 2019)*, Kotor, Montenegro, 2019, 371-375.
- Perčić, M.; Ančić, I.; Vladimir, N. Towards electrification of ro-ro passenger fleet in the Adriatic Sea. *Proceedings of the RINA Power & Propulsion Alternatives for Ships Conference*. London, UK, 2019, 41-46.

7. Summary of articles

ARTICLE 1: Ančić, I.; Perčić, M.; Vladimir, N. Alternative power options to reduce carbon footprint of ro-ro passenger fleet: A case study of Croatia. *Journal of Cleaner Production* 2020, 271: 122638.

Emissions produced by fuel oil combustion in marine engines contribute to marine environment pollution and have a negative impact on both human health and the environment. This impact is more pronounced for ships which mostly operate near ports and inhabited areas, such as ro-ro passenger ships. The relevant legislation prescribes a reduction of carbon dioxide on account of its contribution to the problem of global warming. This paper deals with the assessment of the carbon footprint of the Croatian ro-ro passenger fleet in the Adriatic Sea and the corresponding measures to reduce it. This paper analyses a total of 27 ferry lines along the Croatian coast that produce around 29,000 tons of carbon dioxide annually. The analysis distinguishes two lines, Valbiska-Lopar and Vis-Split, with a significantly higher relative contribution to total emissions. The potential to introduce measures to reduce the carbon footprint on these lines is discussed. By implementing these measures, the carbon footprint of the Valbiska-Lopar line can be reduced by almost 40%, while that of the Vis-Split line can be lowered by around 27%.

In ARTICLE 1 Maja Perčić contributed with the formal analysis, investigation, visualization, software, resources, writing of the original draft, and editing of the revised manuscript. Assistant Professor Ivica Ančić was responsible for conceptualization, formal analysis, investigation, methodology, resources, writing of the original draft, and reviewing and editing of the revised manuscript. Associate Professor Nikola Vladimir contributed to the conceptualization, formal analysis, investigation, methodology, resources, validation, writing of the original draft, editing of the revised manuscript, supervision, project administration and funding acquisition.

ARTICLE 2: Perčić, M.; Ančić, I.; Vladimir, N. Life-cycle cost assessments of different power system configurations to reduce the carbon footprint in the Croatian short-sea shipping sector. *Renewable and Sustainable Energy Reviews* 2020, 131: 110028.

In order to comply with stringent environmental regulations, shipbuilders and ship-owners are seeking cleaner fuels and the integration of renewable energy sources into ship power systems. Such solutions regularly result in additional costs for ship operators, both in the case of retrofitting existing ships or acquiring completely new vessels. This paper deals with the life-cycle cost assessments (LCCAs) of different power system configurations of a ro-ro passenger vessel operating in the Croatian short-sea shipping sector. Electrification of the ship is considered as an option to reduce the carbon footprint (CF) of the vessel and to achieve economic savings during its lifetime. In this sense, the ship operational profile is analysed and its total power needs are determined. The life-cycle assessments of an existing diesel engine-powered solution and two potential battery-powered ship options (with and without photovoltaic cells) are performed by means of GREET 2018 software. Furthermore, these options are compared from an economical viewpoint, where different carbon credit scenarios are investigated. The results show that a diesel engine-powered vessel has the highest carbon footprint, as expected. However, it is also found that a battery-powered vessel (with or without photovoltaic cells) has a minimum environmental footprint and at the same time represents economically the most favourable solution for all possible carbon allowance scenarios. This indicates that all-electric ships seem to be a promising option for the future development of the Croatian short-sea shipping sector.

In ARTICLE 2 Maja Perčić was responsible for conceptualization, methodology, software, formal analysis, investigation, visualization, resources, writing of the original draft, and editing of the revised manuscript. Assistant Professor Ivica Ančić was responsible for conceptualization, formal analysis, investigation, methodology, resources, writing of the original draft, and reviewing and editing of the revised manuscript. Associate Professor Nikola Vladimir contributed to the conceptualization, formal analysis, investigation, methodology, resources, validation, writing of the original draft, editing of the revised manuscript, supervision, project administration and funding acquisition.

ARTICLE 3: Perčić, M.; Vladimir, N.; Fan, A. Life-cycle cost assessment of alternative marine fuels to reduce the carbon footprint in short-sea shipping: A case study of Croatia. *Applied Energy* 2020, 279: 115848.

The reduction of emissions generated by internal combustion engines represents one of the most important research topics in the marine sector. This especially refers to carbon dioxide (CO₂) which is a major greenhouse gas. This paper deals with the viability of alternative fuels to reduce CO₂ emissions in the Croatian short-sea shipping sector over a ship lifetime. The aim of the study is to identify appropriate alternatives to diesel-powered options, taking account of environmental and economic criteria. Besides diesel, which is currently the main marine fuel in Croatia, an analysis was conducted of electricity, methanol, dimethyl ether, natural gas, hydrogen and biodiesel, and the results are illustrated on three different Croatian ro-ro passenger ships, operating on short, moderate and relatively long routes, respectively. Life-Cycle Assessment (LCA) indicated the most environmentally friendly power system configuration with alternative fuel. The investigation from an economical point of view was performed by Life-Cycle Cost Assessment (LCCA) which also considered potential carbon allowance scenarios. The results highlighted an electricity-powered ship as the most ecological as well as the most cost-effective option among those that are investigated, taking account of the real Croatian electricity mix that includes 46% of renewable sources.

In ARTICLE 3 Maja Perčić was responsible for conceptualization, methodology, software, formal analysis, investigation, visualization, resources, writing of the original draft, and editing of the revised manuscript. Associate Professor Nikola Vladimir contributed to the conceptualization, formal analysis, methodology, validation, reviewing of the paper, supervision, project administration and funding acquisition. Associate Professor Ailong Fan contributed to the paper with validation, reviewing and visualization.

ARTICLE 4: Perčić, M.; Vladimir, N.; Koričan, M. Electrification of inland waterway ships considering power system lifetime emissions and costs. *Energies* 2021, 14: 7046.

This paper deals with the applicability of alternative power system configurations to reduce the environmental footprint of inland waterway ships. Its original contribution includes: models for assessment of the lifetime emissions and associated lifetime costs of alternative power system configurations for different types of inland waterway vessels, identification of the most cost-effective options for these vessels, and an estimation of the impact of emission policies on the profitability of each option. The case study considers the Croatian inland waterway sector, where three types of vessel with significantly different purposes, designs, and operative profiles are considered (cargo ship, passenger ship, and dredger). The technical and operational features of these ships are analyzed with an emphasis on their energy needs. Then, life-cycle assessments (LCAs) of a diesel engine-powered ship configuration and two battery-powered ship configurations (with and without a photovoltaic system) are performed by means of GREET 2020 software. These configurations are compared from the economical viewpoint, by the life-cycle cost assessment (LCCA), where potential carbon credit scenarios are investigated, while relevant quantities are converted into monetary units. Although the LCA identified the photovoltaic cells' battery-powered ship configuration as the most environmentally friendly, according to the LCCA, its life-cycle costs are rather high, except for passenger ships, for which the battery-powered ship configuration is a feasible option. If a set of required specific input data is known, the presented procedure is applicable to reduce the environmental footprint of any other inland waterway fleet.

In ARTICLE 4 Maja Perčić was responsible for conceptualization, methodology, software, formal analysis, investigation, data curation, validation, visualization, resources, writing of the original draft, and editing of the revised manuscript. Associate Professor Nikola Vladimir contributed to the conceptualization, formal analysis, methodology, data curation, validation, visualization, reviewing of the paper, supervision, project administration and funding acquisition. Marija Koričan contributed to the paper with validation and editing of the revised manuscript.

ARTICLE 5: Perčić, M.; Vladimir, N.; Fan, A. Techno-economic assessment of alternative marine fuels for inland shipping in Croatia. *Renewable and Sustainable Energy Reviews* 2021, 148: 111363.

Emissions reduction targets are pushing the shipping industry towards cleaner and more energy-efficient solutions. One option proposed is to replace conventional marine fuels with cleaner fuels. This is particularly important for vessels engaged in short-sea shipping and inland waterway transportation because their exhaust gases more negatively affect the local population than long-distance ships do. Hence the aim of this study is to undertake a technical, environmental and economic analysis of alternative fuels to reduce the environmental footprint and lifetime costs of inland waterway transportation. The analysis will focus on Croatia whose existing outdated inland waterway fleet needs to meet the goals of the Low-Carbon Development Strategy of the Republic of Croatia. In the study, a life-cycle analysis and life-cycle cost assessment of different alternative fuels will be performed taking into account the operating profiles and technical characteristics of vessels working in Croatia. The potential effects of a carbon tax are also examined in a case study considering carbon emissions reduction targets in Croatia by 2030. The electrification of ships is highlighted as the most environmentally friendly option for each considered ship, reaching a carbon emission reduction of up to 51%, while the most cost-effective option varies for each ship.

In ARTICLE 5 Maja Perčić was responsible for conceptualization, methodology, software, formal analysis, investigation, visualization, resources, writing of the original draft, and editing of the revised manuscript. Associate Professor Nikola Vladimir contributed to the conceptualization, formal analysis, methodology, validation, reviewing of the paper, supervision, project administration and funding acquisition. Associate Professor Ailong Fan contributed to the paper with validation, reviewing and visualization.

ARTICLE 6: Perčić, M.; Vladimir, N.; Jovanović, I.; Koričan, M. Application of fuel cells with zero-carbon fuels in short-sea shipping. *Applied Energy* 2022, 309: 118463.

This paper investigates the viability of different fuel cell types in a ship power system, where hydrogen and ammonia are considered as zero-carbon fuels. The identification of alternatives to diesel-powered ships is performed by taking into account the environmental and economic indicators of the considered power systems, determined by Life-Cycle Assessment (LCA) and Life-Cycle Cost Assessment (LCCA), and further compared with the existing diesel power systems of three passenger ships operating in Croatian coastal waters. Special attention is paid to fuel origin, where fossil fuels (grey fuel), fossil fuels followed by CO₂ capture (blue fuel), and those produced from renewable energy sources (green fuel) are considered. The results of the research indicate that fuel cell systems with grey hydrogen and grey ammonia are not environmentally friendly, while fuel cell systems with the blue and green types of these fuels have a lower impact on the environment than a diesel-powered ship, with a reduction of up to 84% in CO₂-eq emissions when green ammonia is used. Regarding profitability, the diesel-powered ship has the lowest total costs, while the second most cost-effective option is the fuel cell system with blue ammonia as fuel with 27%-43% higher costs than a diesel-powered ship, depending on which type of fuel cell is used. Although blue ammonia is a cheaper fuel than diesel fuel, the lifetime costs of the fuel cell power system are affected by relatively high investment costs (fuel cell, battery, cracker, etc.) and equipment replacement costs.

In ARTICLE 6 Maja Perčić was responsible for conceptualization, methodology, software, formal analysis, investigation, validation, visualization, resources, writing of the original draft, and editing of the revised manuscript. Associate Professor Nikola Vladimir contributed to the conceptualization, formal analysis, methodology, validation, reviewing of the paper, supervision, project administration and funding acquisition. Marija Koričan and Ivana Jovanović contributed with the visualization, writing of the original draft, and editing of the revised manuscript.

ARTICLE 7: Vladimir, N.; Bakica, A.; Perčić, M.; Jovanović, M. Modular approach in the design of small passenger vessels for Mediterranean. *Journal of Marine Science and Engineering* 2022, 10 (1): 117.

This paper deals with the modular concept in the design of small passenger vessels for Mediterranean, where the ship is assembled from three virtual modules (hull, power system and superstructure), enabling different vessel characteristics (speed, capacity, environmental performance, habitability, etc.). A set of predefined modules is established based on the investigation of market needs, where IHS Fairplay database is taken as a reference for ship particulars and power needs, while set of environmental regulation scenarios and regulations on ship habitability are taken as relevant for the design of ship power system and superstructure modules, respectively. For the selected hull, series of computations have been conducted to obtain their resistance and power requirements which are further satisfied in the above-described manner. Within the illustrative example a case of small passenger vessel with a capacity of 250 passengers is considered, with detailed description of relevant modules that fit to future design requirement scenarios. This approach is aimed for small scale shipyard with limited research capabilities, who can quickly get the preliminary design of the vessel which can be further optimized to the final solution.

In ARTICLE 7 Maja Perčić was responsible for conceptualization, software, formal analysis, investigation, validation, visualization and editing and reviewing the manuscript. Associate Professor Nikola Vladimir contributed to the conceptualization, formal analysis, methodology, investigation, resources, writing of the original draft, supervision, project administration and funding acquisition. Andro Bakica contributed to the conceptualization, software, formal analysis, investigation, validation, visualization and editing and reviewing the manuscript. Ivana Jovanović contributed to the validation, investigation, data curation, visualization, and editing and reviewing the manuscript.

ARTICLE 8: Perčić, M.; Vladimir, N.; Fan, A.; Jovanović, I. Holistic energy efficiency and environmental friendliness model for short-sea vessels with alternative power systems considering realistic fuel pathways and workloads. *Journal of Marine Science and Engineering* 2022, 10(5): 613.

The energy requirements push the shipping industry towards more energy-efficient ships, while the environmental regulations influence development of environmentally friendly ships by replacing fossil fuels with alternative ones. Currently used mathematical models for ship energy efficiency, that set the analysis boundaries at the level of ship power system, are not able to consider alternative fuels as a powering option. In this paper, the energy efficiency and emissions index for ships with alternative power systems is formulated taking into account three different impacts on the environment (global warming, acidification, and eutrophication) and considering realistic fuel pathways and workloads. Besides diesel, applications of alternative powering options like electricity, methanol, liquefied natural gas, hydrogen and ammonia are considered. By extending the analysis boundaries from ship power system to the complete fuel cycle it is possible to compare different ships within the considered fleet or a whole shipping sector from a viewpoint of energy efficiency and environmental friendliness. The applicability of the model is illustrated on the Croatian ro-ro passenger fleet. Technical measure of implementation of alternative fuels in combination with an operational measure of speed reduction, results in even greater emissions reduction and increase in energy efficiency. Analysis of the impact of voluntary speed reduction for ships with different power systems resulted in the optimal combination of alternative fuel and speed reduction by a specific percentage from the ship design speed.

In ARTICLE 8 Maja Perčić was responsible for conceptualization, methodology, software, formal analysis, investigation, validation, visualization, resources, writing of the original draft, and editing of the revised manuscript. Associate Professor Nikola Vladimir contributed to the conceptualization, formal analysis, methodology, validation, reviewing of the paper, supervision, project administration and funding acquisition. Associate Professor Aiong Fan contributed to the visualization, validation and reviewing of the paper, while Ivana Jovanović

contributed to the visualization, writing of the original draft, and editing of the revised manuscript.

ARTICLES

ARTICLE 1

Preprint of the published journal article.

Alternative power options to reduce the carbon footprint of ro-ro passenger fleets: A case study of Croatia

Ivica Ančić, Maja Perčić, Nikola Vladimir*

University of Zagreb, Faculty of Mechanical Engineering and Naval Architecture,
Ivana Lučića 5, 10000 Zagreb, Croatia, nikola.vladimir@fsb.hr

Abstract

Emissions produced by fuel oil combustion in marine engines contribute to marine environment pollution and have a negative impact on both human health and the environment. This impact is more pronounced for ships which mostly operate near ports and inhabited areas, such as ro-ro passenger ships. The relevant legislation prescribes a reduction of carbon dioxide on account of its contribution to the problem of global warming. This paper deals with the assessment of the carbon footprint of the Croatian ro-ro passenger fleet in the Adriatic Sea and the corresponding measures to reduce it. This paper analyses a total of 27 ferry lines along the Croatian coast that produce around 29,000 tons of carbon dioxide annually. The analysis distinguishes two lines, Valbiska-Lopar and Vis-Split, with a significantly higher relative contribution to total emissions. The potential to introduce measures to reduce the carbon footprint on these lines is discussed. By implementing these measures, the carbon footprint of the Valbiska-Lopar line can be reduced by almost 40%, while that of the Vis-Split line can be lowered by around 27%.

Keywords: carbon footprint, GHG, ro-ro passenger ship, ship power system, marine environment

Nomenclature

Variables

A	area (m ²)
C_F	conversion factor (t CO ₂ /t fuel)
$CO_2 Index$	relative CO ₂ emission (g CO ₂ /€)
D	diameter (m)
E	electric energy (MJ)
E_{rad}	annual solar irradiation (MJ/m ²)
FOC_{annual}	total annual fuel oil consumption (t)
FOC_{route}	route annual fuel oil consumption (t)
FOC_{trip}	fuel oil consumption per trip (t)
L_{trip}	trip length (km)
N_{trip}	number of trips (-)
P	power (kW)
\bar{P}	average wind power (kW)
$SFOC$	specific fuel oil consumption (g/kWh)
TE	tailpipe emissions (t/year)
$0.5\rho v^3$	wind power density (kW/m ²)
a	parameter (-)
c	parameter (-)
v	speed (kn)

Greek symbols

η	efficiency (-)
--------	----------------

Abbreviations

CF	Carbon Footprint
ECA	Emission Control Area
EEDI	Energy Efficiency Design Index
GHG	Greenhouse Gas
GT	Gross Tonnage
GWP	Global Warming Potential
HFO	Heavy Fuel Oil
HPS	Hybrid Power System
IMO	International Maritime Organization
IPS	Integrated Power System
LCA	Life Cycle Assessment
LNG	Liquefied Natural Gas
MEPC	Marine Environment Protection Committee
PV	Photovoltaic
RO-RO	Roll on - Roll off
SEEMP	Ship Energy Efficiency Management Plan
UNFCCC	United Nations Framework Convention on Climate Change
WROS	World Register of Ships

Subscripts

AE	auxiliary engine
EL	electric power system
ME	main engine
P	propulsion
PV	photovoltaic system
T	total
ave	average
wt	wind turbine

1 Introduction

The earth's climate is driven by the flow of energy from the sun, which arrives mainly in the form of visible light and passes down through the atmosphere to warm the earth's surface. Greenhouse gases (GHGs) in the atmosphere block infrared radiation from escaping into outer space, which is known as the greenhouse effect. As a result, the earth's surface is warming up (global warming) which causes various types of climate change. Human activities are raising these GHGs in the atmosphere, relating to emissions of carbon dioxide (CO₂), methane (CH₄), nitrous oxide (N₂O) and fluorinated gases ([UNFCCC, 2001](#)). In order to control the sources of anthropogenic GHG emissions, a set of regulations has been prescribed, such as the Kyoto Protocol, an international agreement for the reduction of GHG emissions which was adopted in 1997 with the aim of preventing global warming ([Hildén, 2011](#)). The most relevant climate agreement is the Paris Agreement, signed in 2016, which has the goal of holding any increase in the global average temperature to well below 2° C above pre-industrial levels and to reach net-zero global GHGs in the second half of the century ([Bataille et al., 2018](#)).

A major source of global GHGs is the use of fuel oil for the generation of power ([Odeh and Cockerill, 2008](#)), i.e. in the energy and transport sector. In the transport sector, a major contributor to GHGs is road transport, while international shipping was responsible for 2.1% of global GHGs, as reported by the International Maritime Organization (IMO) in its Third GHG study. According to the forecasts presented in the study, the percentage of GHGs emitted from shipping could grow from 50% to 250% by the end of 2050, depending on economic growth and energy development ([IMO, 2014a](#)). This is in clear discrepancy with the Paris Agreement goal.

Emissions from the maritime sector originate from exhaust gases released due to fuel oil combustion in marine engines. They consist of CO₂, carbon monoxide (CO), nitrogen oxides (NO_x), sulphur oxides (SO_x), hydrocarbons (HC) and particulate matter (PM) ([Monteiro et al., 2018](#)). In order to control these emissions, the IMO has adopted numerous regulations. For some more pernicious emissions, such as NO_x and SO_x, the IMO established several Emission Control Areas (ECAs). The emission requirements in the ECAs are stricter than global requirements ([Chen et al., 2018](#)). Even though CO₂ is not considered a hazardous gas, it is still the major GHG. Its increased concentration in the atmosphere causes global warming and so its emission should be regulated. The 72nd session of the IMO's Marine Environment Protection Committee (MEPC of IMO) in 2018 resulted in the adoption of a strategy for the reduction of GHGs from international shipping, according to which at least 50% of annual

GHG emissions needs to be reduced by 2050. Meanwhile, the IMO's strategy has been improved, with the goal to reduce CO₂ by 40% by 2030 and by at least 70% by 2050 compared to 2008, where CO₂ emissions are expressed in amounts of CO₂ relative to the benefit for the society (transport work), ([Ančić and Šestan, 2015](#), [Ekanem Attah and Bucknall, 2015](#), [Bøckmann and Steen, 2016](#)). The objectives of the strategy are in line with the Paris Agreement under the United Nations Framework Convention on Climate Change (UNFCCC) and the United Nations 2030 Agenda for Sustainable Development ([IMO, 2018a](#)). In order to achieve these goals, a set of technical and operational measures has to be implemented, and these goals need to be put in place in national legislation.

These requirements to reduce the CO₂ emission will have a strong impact on the Republic of Croatia. The fleet in the Republic of Croatia consists mostly of outdated ships that will soon need to be replaced by new ships, or at least retrofitted with new power systems. On one hand, this pressure to reduce emissions represents a burden for shipbuilders and shipowners. On the other hand, it offers an opportunity to introduce new energy-efficient and greener technologies. Since switching completely to zero emission ships is rather unrealistic (at least in the near future), the other option is to partially implement certain measures. This should be performed carefully in order to maximise the impact of these measures and to minimise the costs. In Croatia, shipowners and shipbuilders do not have the necessary experience of fleet modernisation and thus require help in assessing which ship should be improved and how. Therefore, the subject of this investigation is to identify which technologies are most suitable for ships operating in the Croatian short sea shipping sector to minimise their environmental footprint.

2 Literature review

2.1 Carbon footprint

The term “carbon footprint” (CF) refers to the amount of CO₂ emissions directly and indirectly caused by an activity or that is accumulated over the life stages of a product ([Wiedmann and Minx, 2008](#)). Depending on the selected system boundaries this can refer to fossil fuel oil consumption only (where only operation of some technical system is analysed), while the total amount of CO₂ emissions released through the life cycle of a product, e.g. the ship life cycle, represents the total CF and can be assessed by the Life Cycle Assessment (LCA)

([Ling-Chin et al., 2016](#)). The CF can be expressed in tons of CO₂ or in tons of CO₂ equivalent (CO₂-eq). In order to evaluate the contribution to the greenhouse effect from different GHGs, the Global Warming Potential has been developed. It represents a measure of how much energy the emission of one ton of a gas will absorb over a given period, relative to the emission of one ton of CO₂, and expressed in CO₂-eq ([EPA, 2019](#)).

Nowadays, CF represents a very important research topic in almost all aspects of human life, and there is a number of recent references dealing with it in different branches of research: tourism ([Rico et al., 2019](#)), civil engineering ([Fenner et al., 2018](#); [Yu et al., 2017](#)), sports ([Wicker, 2019](#)), wastewater treatment ([Delre et al. 2018](#)), agriculture ([Xie et al., 2019](#)), meat production ([Ibidhi et al., 2017](#)), manufacturing ([He et al., 2018](#)), viticulture ([Rugani et al., 2013](#)), the energy sector ([Perry et al., 2008](#); [Yan et al., 2019](#)), etc. The current investigation considers as most interesting CF research in the maritime sector.

2.2 CF reduction measures for ro-ro passenger ships

Oscillating fuel oil prices and stricter regulations related to environmental protection and the reduction of emissions are some of the challenges which the shipping industry is facing today. In light of these challenges, in 2011 the IMO adopted a new regulation on energy efficiency for ships ([IMO, 2011](#)). According to the regulation, every new ship of 400 gross tonnage (GT) and over which is engaged in international shipping should obtain an International Energy Efficiency (IEE) Certificate. For this certificate to be issued, ships must comply with the requirements of the Energy Efficiency Design Index (EEDI) and the Ship Energy Efficiency Management Plan (SEEMP). The EEDI is a technical measure and requires that for every new ship the Attained EEDI has to be calculated and this should not exceed the Required EEDI, which is defined by the EEDI reference line value and the appropriate reduction factor ([Ančić et al., 2018a](#)). The numerator in the EEDI formula generally represents the mass flow of CO₂ produced based on the ship system's power needs, and the denominator represents the benefit for society expressed in tons and nautical miles of passenger/cargo transported.

Even though the primary targets of the regulation are ocean-going vessels, the incentive to increase energy efficiency is also strong for ro-ro passenger ships ([Runko Luttenberger et al., 2013](#)). According to [Torbianelli \(2000\)](#), ro-ro transport refers to roll on - roll off intermodal transport for vehicles that are driven on and off the ship on their own wheels. Ro-ro ships which transport both passengers and vehicles are termed ro-ro passenger ships and these kinds of

ships are usually engaged in short-sea shipping. The term short-sea shipping refers to maritime transport between national ports and between a country's ports and the ports of adjacent countries ([Arof, 2018](#)). A typical example of a ro-ro passenger ship is a ferry. These ships are mostly powered by diesel engines. Emissions from these engines have negative effects on the environment and human health ([Sofiev et al., 2018](#)) and are more pronounced when ships spend greater time near populated areas and in ports manoeuvring or at berth, which is the case for these ships ([Gobbi et al., 2019](#)).

Decarbonisation of the shipping industry can be achieved by implementing technical, operational and market-based measures. In general, technical measures to reduce the CF can be categorised in the following way: hull design, propulsion and power, alternative energy sources and alternative fuels ([Bouman et al., 2017](#)). These measures can reduce emissions by reducing the required power, increasing the energy efficiency of the power system or by using alternative fuel. The required power can be reduced by improving the vessel's propulsion system, or by improving its auxiliary system. The propulsion system can be improved by hull/propeller/speed/route/trim optimisation and the implementation of Energy Saving Devices (ESDs), etc. Energy efficiency can be increased by minimising total losses in the power system. Losses can be minimised either by improving a particular element in the system (for example, the engine) or by rearranging the system (as is the case for the Hybrid Power System (HPS) and Integrated Power System (IPS)). Alternative and cleaner fuels have lower carbon content and hence lower CO₂ emissions. These measures are summarized in Table 1.

Table 1. Technical measures to decarbonise the shipping industry

Technical measures		
Reducing the power demand	Increasing the energy efficiency	Using alternative fuel
Propulsion system	Minimising losses in each element in the ship power system	Fuels with lower carbon content (natural gas, methanol, biofuels, etc.)
<ul style="list-style-type: none"> • hull/propeller/speed/route/trim optimisation • Energy Saving Devices (ESDs) 	Rearranging the power system (hybrid and integrated power systems)	Fuels with zero carbon content (hydrogen, ammonia, etc.)
Auxiliary system		

Technical measures to reduce the CF involve replacing heavy fuel oil (HFO), the most commonly used fuel oil in the shipping sector, with some cleaner or alternative fuel such as

natural gas, hydrogen, methanol, biofuels, ammonia, etc. ([Brynolf et al., 2014](#)). The alternative fuel that is mostly used in shipping is liquefied natural gas (LNG), whose feasibility was considered by [Schinas and Butler \(2016\)](#). Natural gas is liquefied and stored in vacuum tanks at -163 °C, but during its evaporation and pressurisation, in order for the fuel to be compatible with the engine requirements, CH₄ emissions are occasionally released in the atmosphere. This is called “methane slip” and is the main weakness of ships powered by LNG ([Ammar and Seddiek, 2017](#)). According to an LCA comparison of LNG and HFO conducted by [Sharafian et al. \(2019\)](#), for small ships (such as ferries), LNG resulted in similar or even higher GHGs compared to HFO and due to methane slips, which can be reduced through the use of new and energy efficient engines. [Thomson et al. \(2015\)](#) made an LCA comparison of LNG compared to traditional petroleum-based fuels in the marine sector. A comparison of the total fuel cycle with traditional marine fuels shows that LNG can reduce GHG emissions in marine transportation.

Another alternative fuel that could lead to decarbonisation of the shipping sector is hydrogen and its use in fuel cells, electrochemical devices that convert chemical energy directly into electricity ([van Biert et al., 2016](#)). [Deniz and Zincir \(2016\)](#) concluded that hydrogen can be used as a marine fuel, but some improvements in its storage systems are needed. Hydrogen can be stored as liquid ammonia, which can then be used for propulsion, either by the combustion of ammonia or by its use in fuel cells ([Balcombe et al., 2019](#)). Methanol also has a potential for use in the shipping industry. [IMO \(2016\)](#) performed an LCA comparison of conventional fuel oils and methanol. The results showed that the methanol produced from natural gas has higher GHGs than conventional fuels, but methanol produced from biomass has the potential to reduce emissions (GHGs, NO_x, SO_x) significantly. [Svanberg et al. \(2018\)](#) have also shown that the use of biomass to produce renewable methanol as a marine fuel is a technically viable option. The infrastructure and storage facilities can be easily adapted from existing ones, but the disadvantage is high production costs. Even though the application of the above-mentioned alternative fuels in the shipping sector would result in lower or zero GHG emissions, the investment, maintenance and/or production costs are high and represent an economic barrier for use in shipping.

Technical measures are also related to the replacement of the conventional power system (the diesel engine power system) with some HPS or IPS. The main characteristic of an IPS is centralised electric power generation and the application of electric propulsion, while an HPS is characterised by the use of different types of power sources ([Ančić et al., 2018b](#)). [Ahn et al.](#)

(2018) investigated a marine generator-fuel cell-gas turbine HPS in terms of energy efficiency and environmental impact for very large ethane carriers, and concluded that this HPS satisfies CO₂ regulations. [Klebanoff et al. \(2017\)](#) have shown how a hybrid high-speed fuel cell ferry can reduce GHG emissions from shipping, while [Diaz-de Baldasano et al. \(2014\)](#) presented a vessel with hybrid diesel-electric fuel cell propulsion where two high-temperature solid oxide fuel cell systems using methanol were integrated within the ship and resulted in reduced GHGs. Increased fuel oil prices and environmental restrictions have led to a new trend of full electrification of ships. [Gagatsi et al. \(2016\)](#) presented the concept of a fully electric ferry which promotes zero emission shipping by using an on-board battery as the main power source. The main disadvantage of this kind of ship is the price of the battery, which, through the development of technology, may become cheaper. In this way, electric ships are expected to be a more feasible solution to reduce the CF, at least in the short sea shipping sector.

One of the main categories of technical measures focuses on alternative energy sources, e.g. the implementation of renewable power sources on board for power generation which results in the reduction of emitted GHGs, as indicated in many studies. [Ghenai et al. \(2019\)](#) presented a ship with an HPS consisting of a photovoltaic (PV) system, fuel cells and a diesel engine, whose application on board resulted in lower emissions in contrast to emissions released from the ship powered only by a diesel engine. The application of a combination of PV cells, a battery and a diesel engine on a vessel engaged in short sea shipping was presented by [Yu et al. \(2018\)](#) who indicated that this solution resulted in the reduced environmental impact of the ship. A similar investigation was performed by [Yuan et al. \(2018\)](#) where a PV cells-diesel engine powered ship showed a reduction in both diesel consumption and GHG emissions.

A set of CF operational measures is usually implemented under the SEEMP (linked with the shipping company management) and includes slow steaming, voyage optimisation, fleet management, optimised maintenance, etc. These measures do not require hefty initial investment and their application leads to energy savings ([Wan et al., 2018](#)). According to [Armstrong \(2013\)](#), slow steaming stands out among all optimisation solutions whose implementation in the shipping sector could reduce its CF. Slow steaming is a measure of reducing operational speed well below the design speed. Since fuel oil consumption is linked to ship speed, with a reduction of speed, fuel oil consumption is also reduced. This is one positive effect of this measure, while the negative effect can be found in an increase of ships

used in order to maintain the shipping schedule, since a reduction of speed also means more time in operation ([Woo and Moon, 2014](#)). The main technical and operational measures that can be used to reduce the CF of ro-ro passenger ships are summarised in Fig. 1.

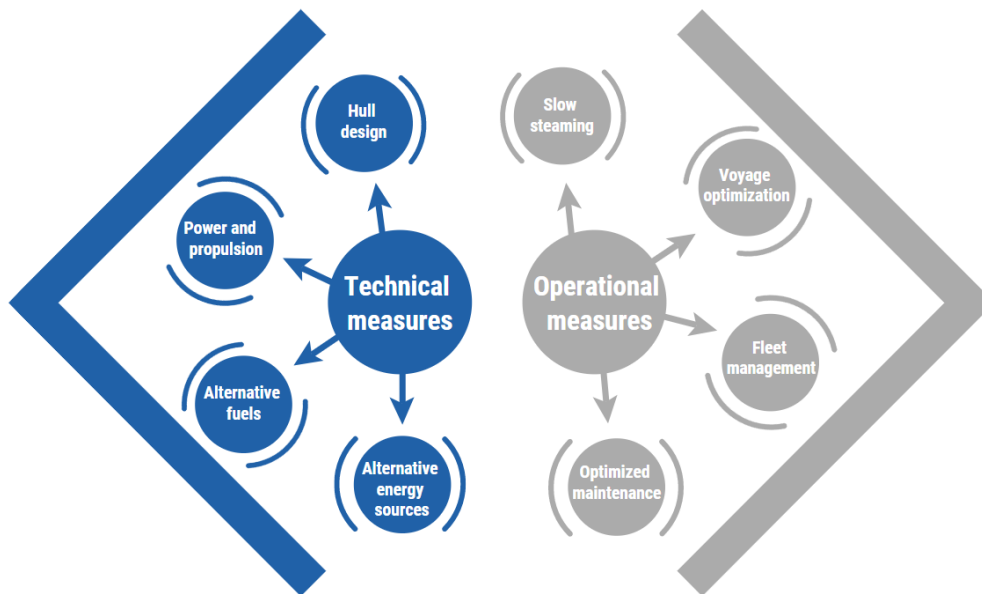

Figure 1 CF reduction measures for the shipping sector

One of the market-based measures is carbon credit. This refers to emission allowances which can be received or bought and even traded, and can play an important role in providing an economic incentive to reduce CF ([Stiglitz et al., 2017](#); [Tvinnereim and Mehling, 2018](#); [Raymond, 2019](#)). Each allowance gives the right to emit 1 ton of CO₂, the main GHG, or the equivalent amount of two more powerful GHGs, N₂O and perfluorocarbons (PFCs) ([EU ETS, 2019](#)). Even though this has not been put into practice yet in the shipping industry, some sectors have already implemented this system, e.g. industry, aviation, electric power sector

2.3 Case study of Croatia

Environmental agreements have obliged the global community to reduce the total amount of GHGs. Among the countries that have ratified these agreements is also the Republic of Croatia. According to the report on GHGs in 2017 by the Croatian Agency for Environment and Nature ([CAEN, 2019](#)), the amount of emissions from the energy sector in the Republic of Croatia is presented in Fig. 2. The energy sector is the main source of anthropogenic GHG emissions, and it accounts for approximately 70% of total GHG emissions in the Republic of Croatia.

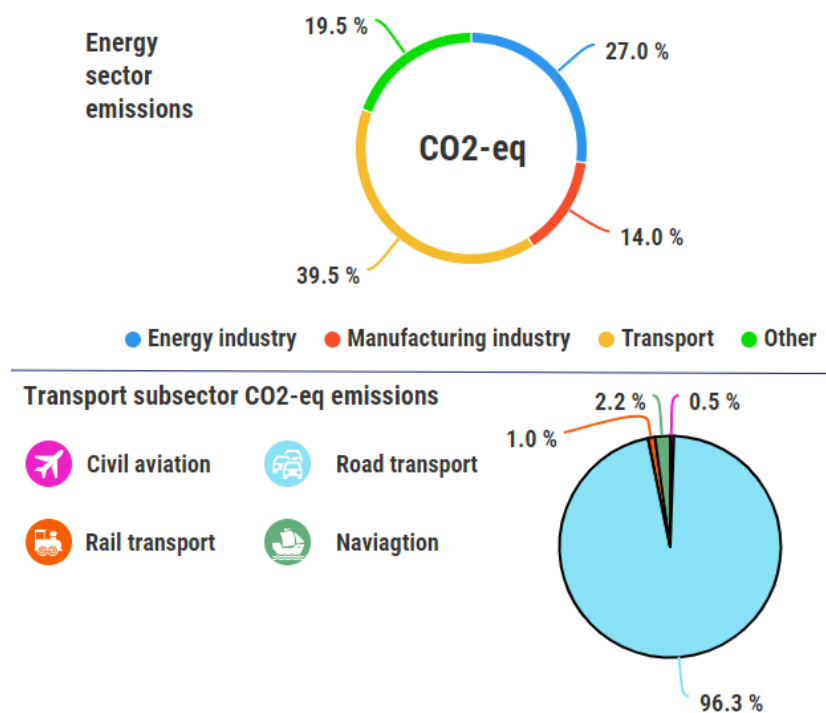

Figure 2 Croatian energy sector GHG emissions for 2017

Although Croatian road transport represents by far the main cause of GHG emissions from the transport sector, air pollution from maritime transport should not be ignored. This becomes clearer if other harmful emissions are also observed, for instance, SO_x emissions. According to the Statistical Yearbook of the Republic of Croatia for 2017 (SYRC, 2018), the highest annual deposition of sulphur in the form of sulphate in the amount of 6.26 kg/ha is in the city Rijeka. This pollution is most likely linked to maritime transport (since Rijeka is the busiest port in Croatia) and the oil refinery stationed nearby. SYRC (2018) also reported that the City of Dubrovnik in 2017 was very polluted with an annual deposition of sulphur of 5.13 kg/ha which is probably the result of it being a popular port for cruise ships. Other measurement spots resulted in a range from 1.44 to 4.92 kg/ha. Introducing measures to control GHG emissions will also have positive impact on reducing the SO_x emissions.

The Croatian Adriatic coastline has numerous islands with many ferry lines that connect the Croatian mainland with the islands, and the islands to each other. The importance of these lines in the Republic of Croatia is very high, not only for the local population, but also for tourists visiting in high numbers, especially during the summer period. Due to tourism, the sensitivity of the marine environment in the Republic of Croatia is increased, since any pollution can have a devastating effect not only on the environment, but also on the entire economy. In this sense, the energy efficiency performance of ro-ro passenger ships has a very

high impact on these communities. The energy efficiency performance of a typical ro-ro passenger ship for the Adriatic Sea had already been assessed by [Ančić et al. \(2018c\)](#) who revealed that this ship does not comply with EEDI requirements, i.e. its CF should be reduced.

The presented literature overview revealed the importance of short sea shipping for coastal communities, and the impact ro-ro passenger ships has on the marine environment. It also showed how various measures can have different effects on the ship's environmental impact on a specific route. But if the shipowner or the ship operator decides to implement these measures on some of its ships, it will face two main problems: (a) how to assess which lines will benefit most from these improvements; and (b) how to assess which measures will have the greatest impact.

This paper follows the UN stance that all industries must make a proportionate contribution to reducing GHG emissions, and it recognises that replacing the current fleet with zero-emission ships in the Republic of Croatia is unrealistic in the near future. The aim of this paper is to evaluate the CF of the Croatian ro-ro passenger fleet. In this assessment, the routes with the highest CF will be analysed in detail in order to identify measures with the highest impact on the CF.

The contribution of the paper can be summarised as follows: (a) defining the *CO₂ Index* for ro-ro passenger ships; (b) developing a model to assess the *CO₂ Index* for ferry lines in the Adriatic Sea; (c) identifying the most feasible measures to reduce the CF on these lines. This work provides support both to shipowners and ship operators, as well as to national regulators, in evaluating the existing routes and identifying the potential to improve energy efficiency and reduce the environmental impact.

3 Methodology

As indicated in the previous section, the CF can be expressed as the total CO₂ emission (in tons of CO₂) or as the total GHG emission (in tons of CO₂-eq). Hence, it represents an absolute value and as such is not directly applicable for a comparison of different ships, i.e. larger ships will inevitably have a higher CF. In order to analyse the CF of the entire fleet, this paper introduces a *CO₂ Index* as the ratio of the ship CF and the benefit to society. The benefit to society can be expressed as an economic output, i.e. as the amount of cargo carried over a certain distance. For tankers or bulk carriers, this can easily be expressed in tons of cargo carried, but, for ro-ro passenger ships, this is a little more complicated to define, since these ships transport two types of cargo: vehicles and passengers. Furthermore, the vehicles

transported can be cars, vans, trailers, trucks, buses, etc., which are all different in volume and weight.

The only comparison which can be made overall is the cost of transport – the ticket for a bigger vehicle is more expensive, hence the economic output is increased as well. Data on the number of passengers and vehicles transported are obtained from the last available annual report by the Croatian Agency for Coastal Liner Shipping ([CACLS, 2017](#)), while data on ticket prices are obtained from the ship operators. Hence, the *CO₂ Index* used in this paper to compare the CF of ro-ro passenger ships is defined as:

$$CO_2 \text{ Index} = \frac{TE}{EO}, \quad (1)$$

where *TE* denotes the ship tailpipe emissions expressed in kg of CO₂, and *EO* denotes the economic output expressed in €. It is not suitable to use data on transported passengers and cars on ferry lines with multiple stops, i.e. connecting several islands. Since only the total annual number of passengers and cars transported by ferry lines is available, it is not possible to distinguish how many passengers and cars were transported to individual islands.

3.1 Model for the CF assessment

In order to calculate the CF of the Croatian ro-ro passenger fleet, it is necessary first to determine its total annual fuel oil consumption *FOC_{annual}*. There are two basic methods to determine *FOC_{annual}*. The first is the top-down approach in which aggregated data on fuel oil consumption for the fleet is used to determine the CF of each ship. Currently, only data on the total annual cost of fuel oil to ship operators are publicly available within their annual financial reports. Since this is an aggregated value of different fuel oil types used for different purposes, it is not possible to use it to determine the fuel oil consumption of each ship. The other method is the bottom-up approach in which data are gathered on the fuel oil consumption per ship and per route. This approach requires either extensive measurements on board which are not usually performed by ship operators, or an accurate model based on which fuel oil consumption can be estimated. The assessment methodology to develop such a model is shown in Fig. 3. First, based on data on the trip duration and the distance between ports, the average speed is calculated for each route. Based on an energy efficiency analysis and the regression curve obtained, the total power demand is determined. These data are necessary for the calculation of fuel oil consumption for a trip, route and a whole ro-ro passenger fleet. In the last step, tailpipe emissions are calculated.

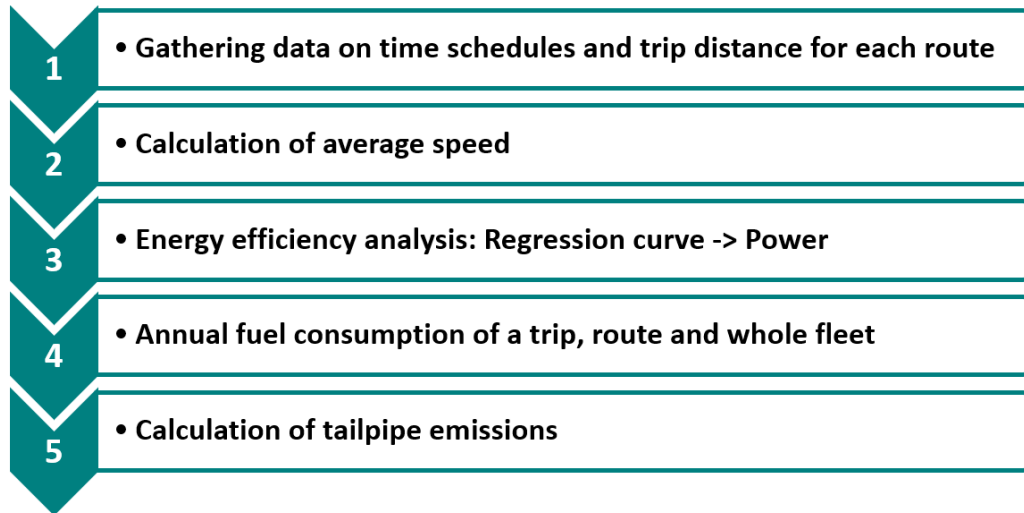

Figure 3 Schematic display of the CF assessment

The system boundaries of this study for GHG accounting include only vessel operation, where tailpipe emissions are considered only. In spite of the limitation that the upstream emissions from the raw materials, manufacturing, etc. in the life-cycle of passenger shipping as well as maintenance are not included in this study, the adopted methodology can reliably identify most contributing ferries and ferry routes to the total CF amounts in Croatian short sea shipping sector.

Data on time schedules and trip distances are obtained from the ship operators' data and satellite maps, respectively. The ship operators' data include the number of trips daily, per week and per season, as well as the average trip duration t_{trip} . The ratio of the trip distance L_{trip} and the trip duration represents the average ship speed on that route:

$$v_{ave} = \frac{L_{trip}}{t_{trip}} \quad (2)$$

Based on the energy efficiency analysis, the ship total power P_T required to attain this speed can be calculated. Values of P_T depend on many parameters, such as ship, route, weather conditions, loading conditions, etc. Since ship operators alter ships on different routes randomly, it is very hard to determine precisely the fuel oil consumption on a specific route. However, it is relatively easy to determine the average speed on a route since the time schedules do not change with the ship. If a faster ship (with higher installed power) is used for the same route as a slower one, it will simply reduce its engine power and sail at a reduced speed in order not to arrive at the destination ahead of schedule. This is particularly pronounced on routes with frequent lines when ships sail in and out of the port one after the other. Arriving early in

that case would imply that the ship has to wait outside the port until the dock clears. It is assumed that while operating at this reduced speed, the total power it uses will be similar to that of the slower ship, i.e. it is assumed the propulsion power used for a route is dependent on the ship speed, regardless of the ship used on that route. A regression curve linking the propulsion power P_P and the average ship speed v can be determined as a power function:

$$P_P = a \cdot v^c, \quad (3)$$

where a and c denote the parameters obtained from the regression analysis. The regression analysis is performed based on the technical data of the ro-ro passenger ships obtained from the World Register of Ships ([WROS, 2013](#)) database. The database shows that all ro-ro passenger ships use diesel-mechanical propulsion, so it can be reliably assumed that the main engine(s) power P_{ME} equals the propulsion power P_P . In order to obtain the total power P_T , auxiliary power demand should also be considered. [IMO \(2014b\)](#) provides guidelines on how to calculate the power of the auxiliary engines P_{AE} for cargo ships and proposes the following relation:

$$P_{AE} = 0.05 \cdot P_{ME} \quad (4)$$

for ships with total installed main engine power up to 10 MW. Since ferries require more auxiliary power, here it is assumed that the auxiliary power is 10% of the main engine power. Therefore, in this paper the following set of equations is applied:

$$\begin{aligned} P_{ME} &= P_P \\ P_{AE} &= 0.1 \cdot P_{ME} \\ P_T &= P_{ME} + P_{AE} \end{aligned} \quad (5)$$

These assumptions lead to some minor inaccuracy, but the only alternative is to monitor every ship's power and speed for a year on every route, and such data are not currently available. Based on this set of equations, the fuel oil consumption for a one-way trip FOC_{trip} can be calculated:

$$FOC_{trip} = P_T \cdot SFOC \cdot t_{trip}, \quad (6)$$

where $SFOC$ denotes the specific fuel oil consumption and t_{trip} denotes the trip duration. $SFOC$ is determined depending on the engine speed and load, as proposed by ([Ančić et al., 2018c](#)), i.e. it is assumed that for high-speed engines the $SFOC$ yields 215 g/kWh. This is an average value which takes into account changes in sailing speed and consequently engine speed and load.

To calculate the average annual fuel oil consumption on a route FOC_{route} , the fuel oil consumption for a one-way trip FOC_{trip} should be multiplied by the number of trips on that route N_{trip} in a year:

$$FOC_{route} = FOC_{trip} \cdot N_{trip} \cdot \quad (7)$$

By applying the same approach for every route and summing up these values, the annual fuel oil consumption of the entire fleet FOC_{annual} can be calculated:

$$FOC_{annual} = \sum_{i=1}^n FOC_{route,i} \cdot \quad (8)$$

The CF depends on the tailpipe emission TE , i.e. the CO₂ emission produced by the combustion of fuel oil. The total tailpipe emissions of the entire fleet TE_T can be calculated using the equation

$$TE_T = FOC_{annual} \cdot C_F, \quad (9)$$

where C_F denotes the conversion factor of fuel to CO₂. The ro-ro passenger fleet in the Adriatic Sea uses “Eurodiesel Blue” as a fuel. This fuel, according to its viscosity, corresponds to Marine Gas Oil (MGO). Therefore, when calculating the TE , the conversion factor for MGO should be used (ISO 8217 Grades DMX through DMB) which equals 3.206 kg CO₂/kg fuel ([IMO, 2014b](#)).

3.2 Methods to reduce the CF

The model described in the previous section can be used to indicate the current status of the Croatian ro-ro passenger fleet and to determine the routes on which the CF is relatively higher. The next step is to identify the appropriate measures to reduce the CF. As indicated in the introduction, various measures have different impacts depending on the ship type, size, power system configuration, route, etc. For upgrading the Croatian ro-ro passenger fleet, the following measures are identified as feasible and are analysed in this paper: speed reduction, replacement of diesel with LNG, implementation of wind power systems, and implementation of a PV system.

Speed reduction implies simply sailing at a lower speed. This increases the duration of a trip, which is inversely proportional to the ship speed. However, it reduces significantly the propulsion power required according to eq. (3). It has to be pointed out that even though the propulsion power can be reduced in this way, the auxiliary engine’s power remains the same.

3.2.1 LNG

In this paper, the focus is on LNG as an alternative fuel for ships. If a simplified approach is adopted, it is possible to estimate the CF reduction when converting to LNG. The average lower heating value (*LHV*) for LNG is around 48 MJ/kg, i.e. around 12% higher than “Eurodiesel Blue”, but engines using LNG have slightly lower efficiency, by around 5%, resulting in a reduction of fuel consumption by about 7%. Since LNG has lower carbon content than “Eurodiesel Blue”, the conversion factor of fuel to CO₂ for LNG is lower, i.e. 2.75 kg CO₂/kg fuel (IMO, 2014b). Finally, by applying eq. (9), tailpipe emissions *TE* of LNG ships can be reduced by roughly 20%. Further reductions are possible through the implementation of innovative energy efficient technologies.

3.2.2 Wind power systems

Wind power can be used to assist the ship propulsion system (as an additional thrust), or it can be used to produce electric power. If the ship has an integrated power system, a double benefit can be achieved, since the electric power produced by the wind power system could be used both for the auxiliary systems and for the propulsion system. For the Croatian fleet, only wind power systems for the production of electric power by wind turbines are analysed. The potential to harvest wind power depends primarily on the wind power density on the selected route, the number of wind turbines installed, and their size. The average available wind power \bar{P} equals:

$$\bar{P} = N \cdot \frac{1}{2} \rho v^3 \cdot A_{wt}, \quad (10)$$

where N denotes the number of wind turbines, $0.5\rho v^3$ denotes the wind power density in kW/m², and A_{wt} denotes the area of a wind turbine in m². A_{wt} can be calculated according to:

$$A_{wt} = \frac{D^2 \pi}{4}, \quad (11)$$

where D denotes the diameter of a wind turbine in m. Since part of the needs of auxiliary power would be covered by a wind power system, both the fuel oil consumption of the auxiliary engine and the tailpipe emission *TE* would be reduced. The reduction in tailpipe emissions ΔTE can be calculated according to:

$$\Delta TE = \bar{P} \cdot SFOC \cdot C_F, \quad (12)$$

where $SFOC$ denotes the specific fuel oil consumption in kg/kWh and C_F denotes the conversion factor of fuel to CO₂.

3.2.3 PV system

Power production from solar energy, similar to power production from wind energy, depends on the weather conditions. The benefits of sunny weather are primarily used in the Republic of Croatia to attract tourists, but can also be used to produce power using a PV system which consists of interconnected PV modules and an electricity transformation system. The advantage of a PV system is that it can directly transform solar power into electric power, but its efficiency is relatively low, at around 12.5% ([EMABCA, 2011](#)). The other limitations of a PV system are related to the weather conditions (sunny weather is required) and where to place it. PV modules are usually placed on the top deck of a ship, far enough away not to disturb the passengers, crew and ship functions. Since the ship moves in different directions, the PV modules are regularly placed horizontally in order to maximise their power output.

The total annual electric energy produced by a PV system E_{PV} on a route can be calculated according to:

$$E_{PV} = \eta_{PV} \cdot E_{rad} \cdot A, \quad (13)$$

where η_{PV} denotes the efficiency of the PV system, E_{rad} denotes the average solar irradiance in MJ/m² (as analysed by [Zaninović et al. \(2008\)](#)), and A denotes the area covered by the PV modules in m² which is limited by the ship's length and breadth. Based on the auxiliary engine power P_{AE} , the total annual ship electric energy needs can be calculated:

$$E_{AE} = \eta_{EL} \cdot P_{AE} \cdot t_{trip} \cdot N_{trip}, \quad (14)$$

where η_{EL} denotes the efficiency of the electric power system (conversion of mechanical into electrical power and distribution of the electrical power), P_{AE} denotes the auxiliary engine power in kW, t_{trip} denotes the trip duration in s, and N_{trip} denotes the number of trips in a year. In addition, the installation of a PV system would reduce the power needs of the air conditioning (AC) system. The AC system usually uses one half of the total auxiliary power produced on board. PV modules provide insulation and can roughly reduce the AC power by one half. The total annual ship electric energy needs would be reduced by around 25%. The impact on fuel oil consumption can be estimated through the following relation:

$$\frac{FOC_{PV}}{FOC_{AE}} = \frac{0.75E_{AE} - E_{PV}}{E_{AE}}, \quad (15)$$

where FOC_{PV} denotes the annual fuel oil consumption of the auxiliary engines with a PV system installed on board in tons, FOC_{AE} denotes the annual fuel oil consumption of the auxiliary engines without a PV system in tons, E_{AE} denotes the annual ship electric energy needs in GJ, and E_{PV} denotes the annual electric energy produced by a PV system in GJ. Based on the FOC_{PV} value and eq. (9), the reduction in tailpipe emissions ΔTE can be calculated:

$$\Delta TE = \frac{FOC_{AE} - FOC_{PV}}{FOC_{AE}} \cdot \frac{P_{AE}}{P_T} \cdot TE, \quad (16)$$

where P_{AE}/P_T denotes the ratio of the auxiliary engine power and the total power, and TE denotes the tailpipe emissions of the ship without a PV system.

4 Results and discussion

The analysis reveals that the majority of the 44 ro-ro passenger ships operating on the Croatian side of the Adriatic Sea are outdated. The average ship age is 26 years, with only six ships under 10 years of age. In total, 27 ferry lines operating in the Adriatic Sea are analysed in this paper (Fig. 4). Twenty-one lines connect the Croatian mainland and islands, one line connects two parts of the Croatian mainland (Ploče-Trpanj), and there are two lines connecting islands with each other (Merag-Valbiska and Lopar-Valbiska), as well as three international lines connecting Croatia and Italy.

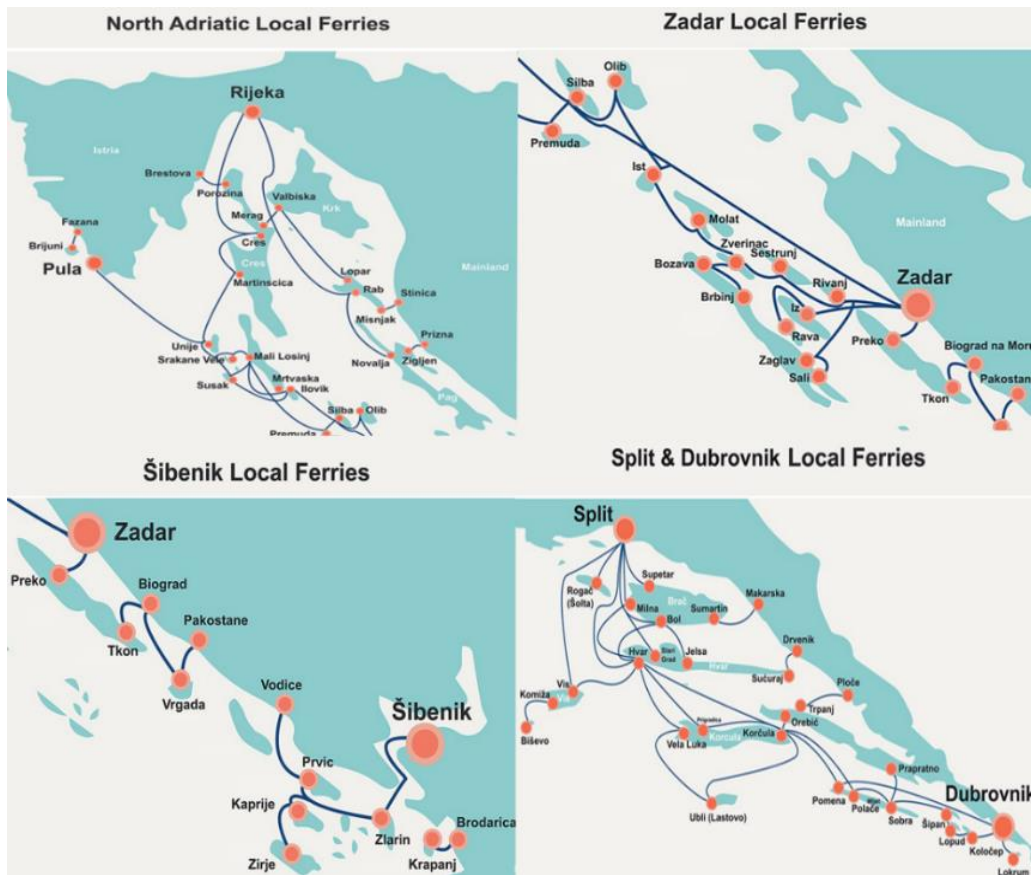

Figure 4 Map of Croatian ferry lines (CF, 2019)

Based on the data in the WROS database, a regression curve between ship speed and engine power is calculated. For 10 of the mentioned 44 ships, data on the ship speed are missing, so the regression analysis is performed for 34 ships (Fig. 5).

The analysis shows that the main engine power can be expressed as a function of ship speed, $P_p = a \cdot v^c$, where parameter a equals 0.0757, and parameter c equals 3.987, with a relatively high value of the coefficient of the determination equalling $R^2 = 0.91$ which indicates a very good correlation. Using the method described in section 3.1, the total annual fuel oil consumption for the ro-ro passenger fleet on the selected routes in the Adriatic Sea is around 9,100 tons. Tailpipe emissions TE , expressed in tons of CO_2 , are calculated according to eq. (9) and amount to around 29,200 tons of CO_2 .

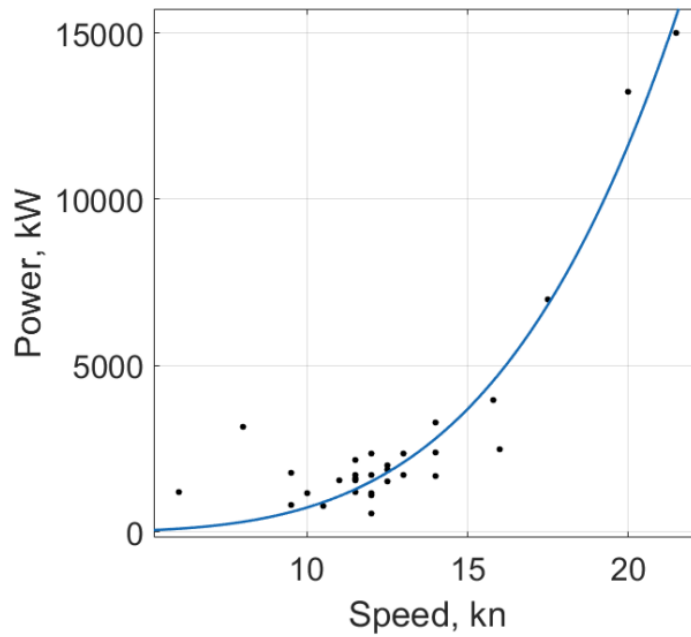

Figure 5 Regression curve defining the propulsion power as a function of speed $P_p = f(v)$

Looking at the ferry lines separately, it can be noticed which lines contribute more to the CF. As noted in the previous section, only ferry lines with one starting point and one destination are observed. In total, there are 16 such lines, and their CO_2 Index is presented in Fig. 6.

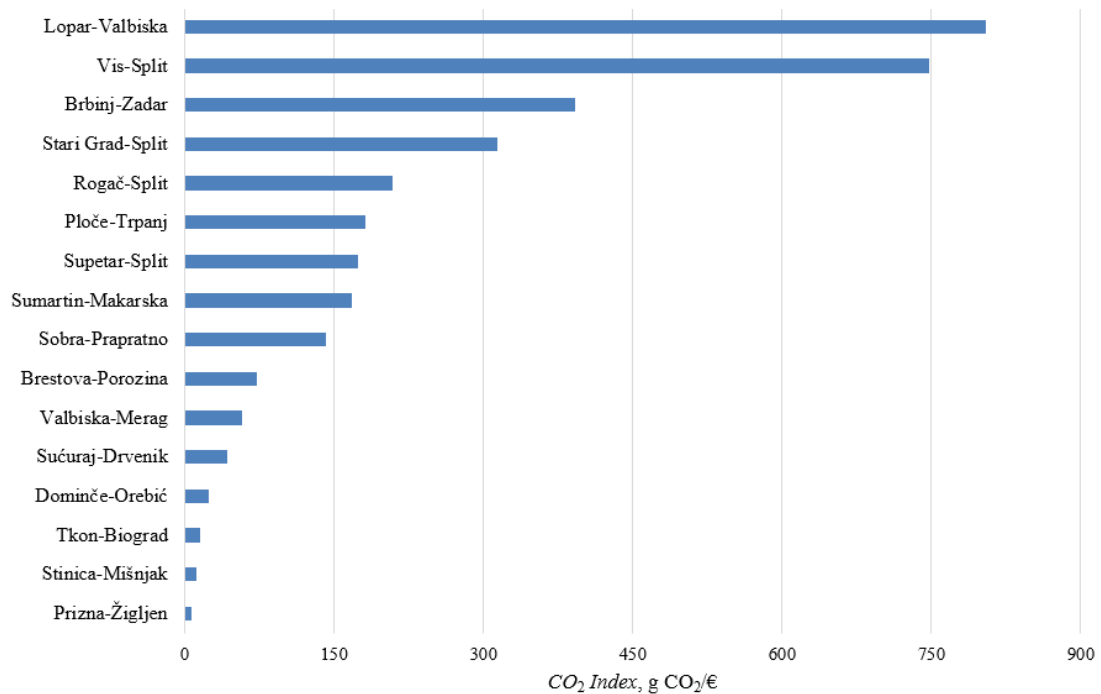

Figure 6 CO_2 Index for ferry lines on the Croatian side of the Adriatic Sea

From the results presented in Fig. 6, two ferry lines can be distinguished: one connecting the island of Vis and the City of Split (Vis-Split), and the other connecting two islands (Rab

and Krk) and their settlements Valbiska and Lopar (Valbiska-Lopar). Detailed data for these two ferry lines are provided in Table 2.

Table 2 Data for two selected ferry lines in 2017

	Valbiska-Lopar	Vis-Split
Trip duration, t_{trip} (min)	80	140
Route length, L_{trip} (nm)	15.3	30.2
Average speed, v_{ave} (knot)	11.5	12.9
Average total power, P_T (kW)	1,399	2,260
Fuel oil consumption per trip, FOC_{trip} (kg)	401	1,134
Trips annually, N_{trip}	960	780
Tailpipe emissions, TE (t CO ₂ /year)	1,234	2,835
Number of passengers transported annually	123,992	261,156
Number of vehicles transported annually	43,106	52,912
Average ticket price for a passenger (€)	4.46	6.49
Average ticket price for a vehicle (€)	22.74	39.63
CO_2 Index (g CO ₂ /€)	805	748

Although ferries on the Vis-Split line emit annually 2,835 tons of CO₂, which is more than twice as much as the Valbiska-Lopar line, it can be noticed that their relative contribution expressed in kg CO₂/€ by the CO_2 Index is lower. In order to improve the energy efficiency and to reduce the CF of these lines, appropriate measures should be taken. This implies a range of different methods and technologies, as indicated in Section 3.2. In the following subsections, these ferry lines are analysed in detail and the impact of speed reduction, alternative fuel, and innovative energy efficient technologies on the CF for the ferry lines Valbiska-Lopar and Split-Vis is assessed.

4.1 Valbiska–Lopar ferry line

The Valbiska-Lopar ferry line connects two neighbouring islands, the island of Krk and the island of Rab. The distance between the ports is 15.3 nautical miles, the trip duration is around 80 minutes with an average sailing speed of 11.5 knots. There is an alternative route which includes a combination of road transport, a bridge crossing from the island of Krk to the mainland, and the Stinica-Mišnjak ferry line connecting the mainland and the island of Rab. Such a combination has several drawbacks: it is a time-consuming trip and depends on the

weather conditions. A trip from Rijeka airport (located on the island of Krk) to the island of Rab would be 57 km and would take 2 hours via the Valbiska-Lopar ferry line, and the trip via the Stinica-Mišnjak ferry line would be 116 km and would take 2.5 hours.

If travelling from the mainland, e.g. if trying to get to Rab from the City of Rijeka, taking the Valbiska-Lopar ferry line means that the destination is still closer, but takes roughly the same time as the alternative Stinica-Mišnjak ferry line. However, since the Stinica-Mišnjak ferry line is shorter, it is cheaper and more attractive and transports significantly more passengers from the mainland to the island of Rab than the Valbiska-Lopar line. The biggest drawback of the Stinica-Mišnjak ferry line is that due to the strong north-east wind called the “Bura”, the ferry line is occasionally interrupted. On the other hand, the Valbiska-Lopar ferry line connects the west sides of the islands and is shielded from that wind. So, in practice, the ferry line Valbiska-Lopar is the alternative route when the Stinica-Mišnjak line is not available, or if passengers are trying to get to the island of Rab directly from the airport.

In this sense, the trip duration of the Valbiska-Lopar ferry line is not essential. By reducing the speed, the duration of the trip would increase, but this should not have a strong impact on the number of passengers and vehicles that are transported by ferry since in these cases there is no alternative. This action would lead to a reduction of P_P according to eq. (3) and hence a reduction of FOC which would reduce the CF of this line. If the ship speed is reduced by 1 knot (from 11.5 to 10.5 knots), the trip duration would increase by 8 minutes (from 80 to 88 minutes), and the propulsion power would be reduced to 892 kW. The total power P_T would then yield 982 kW according to eq. (5), around 420 kW or 30% less than the currently required power (Table 2). This would then result in a reduction of fuel oil consumption of 23%, a reduction of tailpipe emissions to 950 tons CO₂/year, and a reduction of the CO_2 Index to 619.5 g CO₂/€. This is a significant reduction, but the value is still higher than other ferry lines in the Adriatic Sea (Fig. 6).

Further reductions could be achieved by using LNG on board. In this way, a reduction of about 20% could be achieved, i.e. around 247 t CO₂/year. If both a speed reduction and LNG were implemented, then a reduction of 472 t CO₂/year could be achieved.

As can be observed from the wind density map published by [Zaninović et al. \(2008\)](#) (Fig. 7), the mean wind power density closer to the mainland is 100-150 W/m², while in the open sea it is a bit higher and equals 150-200 W/m². Only in some specific channels does the wind power density amount to 450 W/m². Interestingly, the Valbiska-Lopar route is one of these

routes where the wind power density is quite high, even reaching over 400 W/m^2 , with an average of around 350 W/m^2 . If two wind turbines of 8 m in diameter were installed on board, one on the bow and the other on the stern, the average available wind power would then be 35.2 kW according to eq. (10). The reduction in tailpipe emissions would be around 24.3 kg CO_2/h , or 213 tons annually according to eq. (12), representing a CF reduction of about 17%.

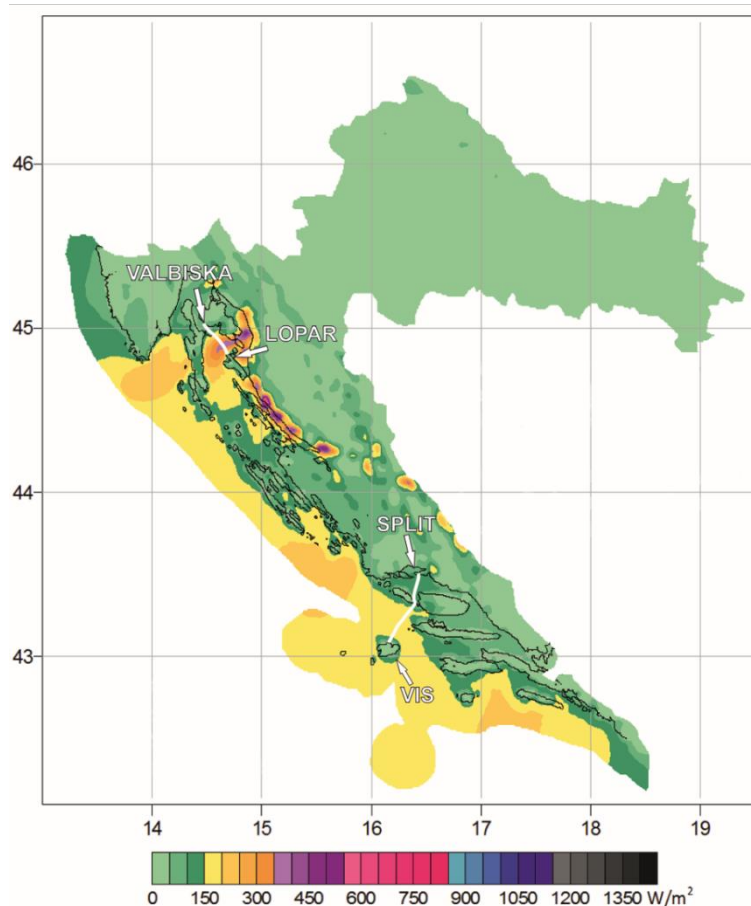

Figure 7 Mean annual wind power density ([Zaninović et al., 2008](#))

The average solar irradiance in the Republic of Croatia was analysed by [Zaninović et al. \(2008\)](#) and can be presented by a map (Fig. 8). The map represents an estimate, since detailed data are available only for specific meteorological stations. The closest station to the Valbiska-Lopar ferry line is the City of Rijeka, while for the Split-Vis line the closest station is the island of Hvar (which is roughly half way between these ports). For Rijeka, the average solar irradiation is $4,807 \text{ MJ/m}^2$ for horizontal cells and $5,260 \text{ MJ/m}^2$ for cells positioned at 45° , while for Hvar, the average solar irradiation is $5,705 \text{ MJ/m}^2$ for horizontal and $6,370 \text{ MJ/m}^2$ for aligned cells. Since it is not feasible to position PV cells at 45° on board ships, the data for horizontal cells are used.

On this route, smaller ships are usually employed. Hence, the area available for the installation of a PV system is smaller and is estimated to be around 450 m². According to eq. (13), the PV system output would be around 270 GJ annually and result in about a 76% reduction in the auxiliary engine fuel oil consumption according to eq. (15). Since the ship on this line has relatively low auxiliary engine power, the total tailpipe emissions would be reduced by around 85 tons of CO₂ per year, i.e. around 6.9%.

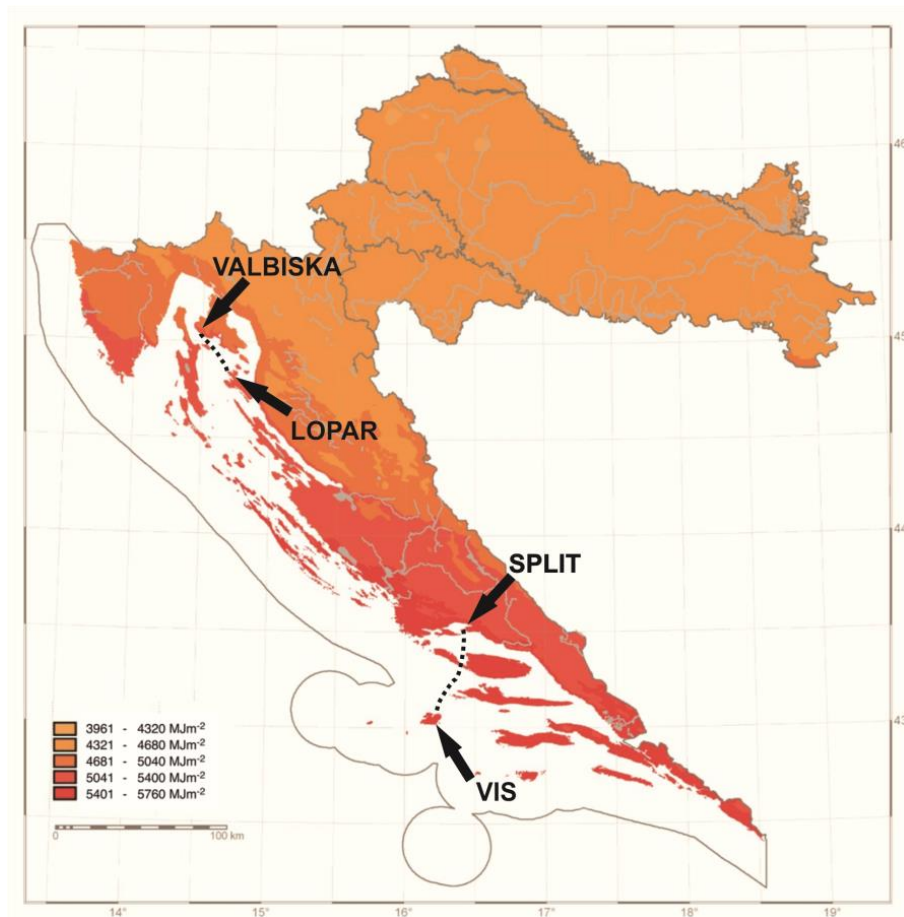

Figure 8 Mean annual solar irradiation ([Zaninović et al., 2008](#))

4.2 Vis-Split ferry line

The second ferry line, Vis-Split, is a ferry line connecting the island of Vis and the second largest Croatian city, Split. This ferry line is the longest continuous Croatian ferry line, for which the trip duration is 140 minutes with an average sailing speed of 12.9 knots. Reducing the speed would reduce the CO₂ emission, as in the previously considered line, which would ultimately result in a lower CF. But the speed reduction on this ferry line has not been considered, because it would increase the trip duration that is already very long and make the island less attractive, with a potentially negative impact on tourism activities.

The only alternative for a tourist visiting the island of Vis is the fast ship line (Vis-Hvar-Milna-Split) that has a shorter trip duration than the ferry line. The average ticket price for passengers is a bit higher, but the weakness of this fast ship line is that it can transport only passengers and not vehicles. Therefore, the ferry line is more attractive for tourists. Since the fuel oil consumption per trip is relatively high, this line seems suitable for the implementation of innovative energy-efficient technologies and alternative fuels. As described in the previous section, replacing “Eurodiesel Blue” with LNG would reduce tailpipe emissions by around 20%, i.e. around 567 t CO₂/year.

On the Split-Vis ferry line route, the mean annual wind power density is significantly lower than on the Valbiska-Lopar line, about 150 W/m² on average. Since more passengers are transported on the Split-Vis line, usually larger ships are used, so the installation of wind turbines with a higher diameter (around 10 m) is also possible. However, the reduction of tailpipe emissions would still be lower when compared to the Valbiska-Lopar route and amount to less than 100 tons. This represents a reduction of less than 3.2% and hence it is not considered as a viable option on this route.

As mentioned above, the annual solar irradiance on the Split-Vis route is a little higher, and usually larger ships are used (with a length between perpendiculars of around 90 m). Therefore, the available area to be covered by PV modules is somewhat larger, estimated at around 900 m². The total annual electric energy produced per year on this route would then be around 642 GJ according to eq. (13). Since the installation of a PV system would help reduce the air conditioning (AC) system power, the total annual ship electric energy calculated by eq. (14) would be further reduced by 25% and amount to around 908 GJ. This implies, according to eq. (15), that the auxiliary engine fuel oil consumption would be reduced by around 78%, resulting in a reduction of tailpipe emissions of 201 t/year according to eq. (16) which represents a reduction in the CF of 7.1%.

4.3 Implications of the analysed improvements to sustainability

Based on the analysis in the previous section, it is possible to determine the impact of different methods and technologies on tailpipe emissions for the selected routes. Table 3 summarises the impact of the observed methods to reduce the CF.

Based on these summarised values, the options with a higher impact on the CF can be identified. The analysis reveals that for the Valbiska-Lopar ferry line, a speed reduction and the installation of a wind power system would have the highest impact on the CF, while for the

Split-Vis route the most effective measures would be conversion to LNG and the implementation of a PV system. The proposed improvements for the Valbiska-Lopar route would result in a reduction of tailpipe emissions of 494 tons, i.e. the *CO₂ Index* would be reduced to 483 g CO₂/€. For the Split-Vis route, tailpipe emissions would be reduced by 768 tons and the *CO₂ Index* would be lowered to 545 g CO₂/€.

Table 3 Reduction of tailpipe emissions for each alternative solution

Options	Valbiska-Lopar		Vis-Split	
	Tailpipe emissions, <i>TE</i> (t CO ₂ /year)			
	Current value	Estimated reduction	Current value	Estimated reduction
Speed reduction	1,234	281	2,835	N/A
LNG		247		567
Speed reduction and LNG		472		N/A
Wind power		213		91
Solar power		85		201

However, in order to achieve these reductions, several limitations should be addressed. For the conversion to LNG, the first requirement is to have LNG available for bunkering. For the Vis-Split line, this currently represents an issue since LNG is not available in the port for bunkering. Split, as the largest coastal city, already has an LNG infrastructure for other industries, so extending this network to the port should not be very demanding.

The main limitation of wind turbines on board ships is wind power density, and the potential to harvest wind energy depends on it. If this value is low, the total energy output of wind turbines would be low. The placement of wind turbines on the deck also represents a limitation. Due to their large dimensions, placement must be carefully considered: turbines need to be placed far enough away not to disturb the crew or the operation of the ship, not to represent a danger to the crew or passengers, and to produce as little noise as possible ([Ionescu et al., 2015](#)). In the last decade, numerous stationary wind turbines have been installed along the Croatian coastline, so it seems this option might be attractive to shipowners as well.

The limitations of PV systems on board ship are primarily caused by the size and position restrictions. PV modules can be conveniently located on the ship top deck, but the area is limited by the ship main particulars, as is their available power output, eq. (13). Unlike in a stationary application, when the PV modules are adjusted to an optimal angle towards the sun, on ships they are positioned horizontally to accommodate differences in the direction of navigation. As a consequence, the average solar irradiation is somewhat lower. Another issue is the continuous operation in the marine environment, which implies that the PV modules should withstand salt and corrosive effects. But, as noted previously, irradiation in Croatia is quite high and the fact that PV modules provide shade and reduce AC power could open the way for the implementation of PV systems, particularly on larger ships in the southern part of the Adriatic Sea.

It also has to be noted that the ship speed considered in the *CO₂ Index* calculation is assumed to be constant. As already mentioned, ship speed depends on numerous parameters, primarily the weather, sea currents, the loading condition, etc., and varies along the way. These variations are particularly pronounced during manoeuvrings when the ship docks and undocks, but they are still relatively similar on every route. Since the aim of this study is to compare different routes, such variations are not so significant. However, the impact of the weather on ship speed and consequently on the CF should not be neglected. Hence, a sensitivity analysis is performed. In this analysis, the ship speed is varied. If the weather is favourable, e.g. if the ship follows the water current, then the propulsion power would be reduced. This is considered to correspond to a speed reduction of 1 knot and is presented as the “Min scenario”. If the weather is rough, e.g. due to the wind and waves, the propulsion power should be increased significantly. This is considered to correspond to a speed increase of 2 knots and is presented as the “Max scenario”. Auxiliary power needs are assumed to remain constant in both scenarios.

The total annual GHG emissions under the Min scenario were reduced from 29,200 to 21,300 t CO₂, while under the Max scenario they were increased to 52,800 t CO₂. The results of the sensitivity analysis for each line are presented in Fig. 9. For five lines with the highest values of the *CO₂ Index*, the relative relations remain unchanged. This is partially due to the fact that the speed on these lines is higher than average. But for some other lines there are noticeable difference. This is especially pronounced for the Sumartin-Makarska line for which the emissions under the Max scenario increased almost three times. When comparing this line

and the Rogač-Split line, under the Max scenario their emissions are roughly the same, while for the Min scenario, the Rogač-Split line has around a 40% higher CO_2 Index.

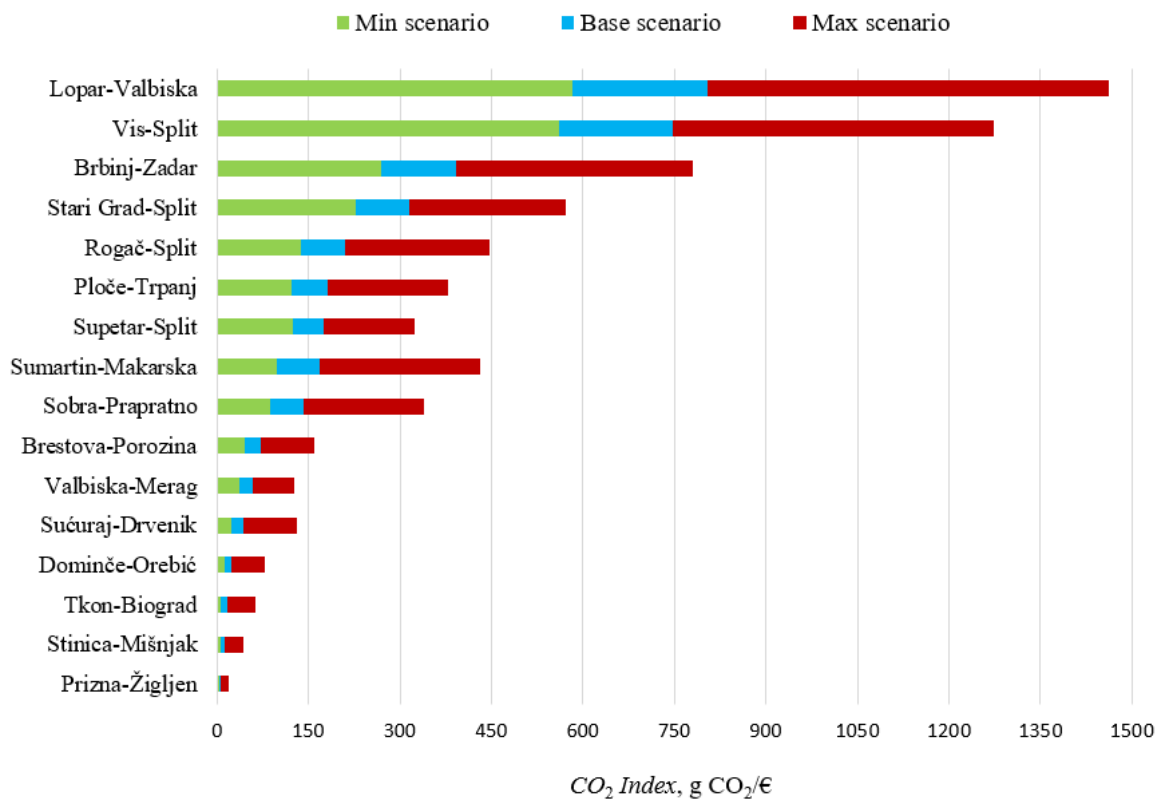

Figure 9. Sensitivity analysis

Another option that could be used to reduce the CF is the inclusion of a carbon allowances policy, i.e. carbon credit. Allowances are certificates that entitle the holder to emit a unit of pollutant, in this case a ton of CO₂. The number of allowances is fixed and issued by governments ([Synapse, 2016](#)). [Trivyza et al. \(2019\)](#) investigated four different carbon credit scenarios which can be implemented in the shipping industry. These scenarios differ in the cost of the CO₂ emission allowance: a non-taxation (NT) scenario represents the current situation in the shipping industry, i.e. carbon credit is not implemented, while current policies (CP), new policies (NP) and sustainable development (SD) scenarios are carbon credit scenarios. Since it follows the 2030 Agenda of the United Nations for Sustainable Development ([EC, 2019](#)), the SD scenario is very rigorous and its implementation in the shipping industry would stimulate shipowners and ship operators to apply energy-efficient technologies. This would give an advantage to ships with cleaner and greener operations and would create an incentive to lower emissions whenever this can be done for less than the price of the allowances.

5 Conclusion

In this paper, the CF of the Croatian ro-ro passenger fleet is analysed. The analysis is carried out related to 27 ferry lines. Two lines with the highest *CO₂ Index* are analysed in detail and measures with the highest impact on the CF are identified. The main findings of the paper can be summarised as follows:

- Annual tailpipe emissions from the Croatian ro-ro passenger fleet on 27 ferry lines amount to about 29,000 tons of CO₂;
- The Valbiska-Lopar and Vis-Split ferry lines make the highest relative contribution to the overall CF, i.e. their *CO₂ Index* equals 805 and 748 g CO₂/€, respectively, and these lines are identified as having the highest potential for the reduction of emissions through various measures;
- For the Valbiska-Lopar line, a combination of speed reduction and wind turbines would significantly decrease CO₂ emissions and reduce its *CO₂ Index* to 483 g CO₂/€, while not affecting the passengers notably;
- For the Vis-Split line, speed reduction is not feasible due to the trip duration, but conversion to LNG and the installation of a PV system would reduce its *CO₂ Index* to 545 g CO₂/€;
- The exploitation of renewable energy sources is location specific, i.e. it depends on the weather conditions (insolation, wind density, wave and current conditions, etc.). In order to achieve significant CF reduction, renewable energy sources need to be exploited in line with the location where the ship sails. Therefore, a PV system is more appropriate for use on locations where insolation is higher, i.e. the southern part of the Adriatic Sea where the Vis-Split line is located, while the use of wind turbines would be better on board in the northern part of the Adriatic Sea, where the wind density is higher and where the ferry connects the settlements of Valbiska and Lopar.
- A sensitivity analysis was performed where the ship speed was varied. The results show that if the ships in the Croatian short sea shipping sector reduced their average speed by 1 knot, the total annual GHG emissions would be reduced from 29,200 t to 21,300 t.

In the second stage, which is the subject of further investigation, the technical characteristics of ships operating on relevant lines should be determined in order to propose a configuration resulting in the highest energy efficiency improvement and CF reduction for each

line. For a particular ship, it is highly recommended to perform an LCA that will offer a complete insight into its environmental impact, as well as into the impact of different solutions leading to a reduction in the CF.

Acknowledgement

This research was supported by the Croatian Science Foundation under the project Green Modular Passenger Vessel for the Mediterranean (GRiMM) (Project No. UIP-2017-05-1253). Maja Perčić, a doctoral student, is supported through the “Young Researchers' Career Development Project – Training of Doctoral Students” of the Croatian Science Foundation, funded by the European Union from the European Social Fund. Funding within the international collaborative project “Global Core Research Center for Ships and Offshore Plants” (GCRC-SOP, No. 2011-0030669), established by the Republic of Korea Government (MSIP) through the National Research Foundation of South Korea (NRF), is gratefully acknowledged.

Literature

- Ahn J., Ho Park S., Noh Y., Il Choi B., Ryu J., Chang D., Brendstrup K.L.M, 2018. Performance and availability of a marine generator-solid oxide fuel cell-gas turbine hybrid system in a very large ethane carrier. *Journal of Power Sources*. 399, 199-206.
- Ammar N.R., Seddiek I.S., 2017. Eco-environmental analysis of ship emission control methods: Case study RO-RO cargo vessel. *Ocean Engineering*. 137, 166-173.
- Ančić I., Šestan, A., 2015. Influence of the required EEDI reduction factor on the CO₂ emission from bulk carriers. *Energy Policy*. 84, 107-116.
- Ančić I., Theotokatos G., Vladimir N., 2018a. Toward improving energy efficiency regulations of bulk carriers. *Ocean Engineering*. 148, 193-201.
- Ančić I., Vladimir N., Runko Luttenberger L., 2018b. Energy efficiency of ro-ro passenger ships with integrated power system. *Ocean Engineering*. 16, 350-357.
- Ančić I., Vladimir N., Cho D. S., 2018c. Determining environmental pollution from ships using Index of Energy Efficiency and Environmental Eligibility (I4E). *Marine Policy*. 95, 1-7.
- Armstrong V.N., 2013. Vessel optimisation for low carbon shipping. *Ocean Engineering*. 73, 195-207.
- Arof A.M., 2018. Decision Making Model for Ro-Ro Short Sea Shipping Operations in Archipelagic Southeast Asia. *The Asian Journal of Shipping and Logistics*. 34 (1), 33-42.
- Balcombe P., Brierley J., Lewis C., Skatvedt L., Speirs J., Hawkes A., Steffel I., 2019. How to decarbonise international shipping: Options for fuels, technologies and policies. *Energy Conversion and Management*. 182, 72-88.
- Bataille C., Åhman M., Neuhoff K., Nilsson L.J., Fishedick M., Lechtenböhmer S., Solano-Rodriguez B., Denis-Ryan A., Steiber S., Waisman H., Sartor O., Rahbar S., 2018. A review of technology and policy deep decarbonization pathway options for making energy-intensive industry production consistent with the Paris Agreement. *Journal of Cleaner Production*. 187, 960-973.
- Bouman E.A., Lindstad E., Riialand A.I., Strømman A.H., 2017. State-of-the-art technologies, measures, and potential for reducing GHG emissions from shipping – A review. *Transportation Research Part D: Transport and Environment*. 52, Part A, 408-421.
- Bøckmann, E., Steen, S. 2016. Calculation of EEDI_{weather} for a general cargo vessel. *Ocean Engineering*, 122, 68-73.

- Brynnolf S., Fridell E., Andersson K, 2014. Environmental assessment of marine fuels: liquefied natural gas, liquefied biogas, methanol and bio-methanol. *Journal of Cleaner Production*. 74, 86-95.
- Chen L., Yip T.L., Mou J., 2018. Provision of Emission Control Area and the impact on shipping route choice and ship emissions. *Transportation Research Part D: Transport and Environment*, 58, 280-291.
- Croatian Agency for Coastal Liner Shipping (CACLS), 2017. Traffic of passengers and vehicles on state lines, http://www.agencija-zolpp.hr/Portals/12/download/Promet_putnika_i_vozila_2017.pdf (accessed 04 December 2019).
- Croatian Agency for Environment and Nature (CAEN), 2019. Croatian greenhouse gas inventory for the period 1990 - 2017 (National Inventory Report 2019), http://www.haop.hr/sites/default/files/uploads/dokumenti/012_klima/dostava_podataka/I_zvjesca/NIR_2019.pdf (accessed 04 December 2019).
- Croatian Ferries (CF). <https://www.croatiaferries.com/island-hopping-croatia/> (accessed 03 December 2019).
- Delre A., ten Hoeve M., Scheutz C., 2018. Site-specific carbon footprints of Scandinavian wastewater treatment plants, using the life cycle assessment approach. *Journal of Cleaner Production*. 211, 1001-1014.
- Deniz C., Zincir B., 2016. Environmental and economical assessment of alternative marine fuels. *Journal of Cleaner Production*. 113, 438-449.
- Díaz-de-Baldasano M.C., Mateos F.J., Núñez-Rivas L.R., Leo T.J., 2014. Conceptual design of offshore platform supply vessel based on hybrid diesel generator-fuel cell power plant. *Applied Energy*. 116, 91-100.
- Ekanem Attah, E., Bucknall, R. 2015. An analysis of the energy efficiency of LNG ships powering options using the EEDI. *Ocean Engineering*. 110, Part B, 62-74.
- Energy Market Authority and Building and Construction Authority (EMABCA), 2011. Handbook for solar photovoltaic (PV) systems, ISBN: 978-981-08-4462-2, http://www.bca.gov.sg/publications/others/handbook_for_solar_pv_systems.pdf (accessed 04 December 2019).
- Environmental Protection Agency (EPA). Understanding the Global Warming Potentials, <https://www.epa.gov/ghgemissions/understanding-global-warming-potentials> (accessed 04 December 2019).

- EU Emissions Trading System (EU ETS), https://ec.europa.eu/clima/policies/ets_en (accessed 09 December 2019).
- European Commission (EC), The 2030 Agenda for Sustainable Development and the SDGs https://ec.europa.eu/environment/sustainable-development/SDGs/index_en.htm (accessed 09 December 2019).
- Fenner A.E., Kibert C.J., Woo J.H., Morque S., Razkenari M., Hakim H., Lu X., 2018. The carbon footprint of buildings: A review of methodologies and applications. *Renewable and Sustainable Energy Reviews*. 94, 1142-1152.
- Gagatsi E., Estrup T., Halatsis A., 2016. Exploring the potentials of electrical waterborne transport in Europe: the E-ferry concept. *Transportation Research Procedia*. 14, 1571-1580.
- Ghenai C., Bettayeb M., Brdjanin B., Hamid A.K., 2019. Hybrid solar PV/PEM fuel Cell/Diesel Generator power system for cruise ship: A case study in Stockholm, Sweden. *Case Studies in Thermal Engineering*. 14. <https://doi.org/10.1016/j.csite.2019.100497>.
- Gobbi G.P., Di Liberto L., Barnaba F., 2019. Impact of port emissions on EU-regulated and non-regulated air quality indicators: The case of Civitavecchia (Italy). *Science of The Total Environment*. 134984. <https://doi.org/10.1016/j.scitotenv.2019.134984>.
- He B., Pan Q., Deng Z., 2018. Product carbon footprint for product life cycle under uncertainty. *Journal of Cleaner Production*. 187, 459-472
- Hildén M., 2011. The evolution of climate policies e the role of learning and evaluations. *Journal of Cleaner Production*. 19, 1798-1811.
- Ibidhi R., Hoekstra A.Y., Gerbens-Leenes P.W., Chouchane H., 2017. Water, land and carbon footprints of sheep and chicken meat produced in Tunisia under different farming systems. *Ecological Indicators*. 77, 304-313.
- International Maritime Organization (IMO). Marine Environment Protection Committee (MEPC), 2011. Resolution: MEPC 203 (62). London, UK, [http://www.imo.org/en/KnowledgeCentre/IndexofIMOResolutions/Marine-Environment-Protection-Committee-\(MEPC\)/Documents/MEPC.203\(62\).pdf](http://www.imo.org/en/KnowledgeCentre/IndexofIMOResolutions/Marine-Environment-Protection-Committee-(MEPC)/Documents/MEPC.203(62).pdf) (accessed 21 November 2019)

- International Maritime Organization (IMO), 2014a. Third IMO GHG Study. Executive Summary and Final Report, <http://www.imo.org/en/OurWork/Environment/PollutionPrevention/AirPollution/Documents/Third%20Greenhouse%20Gas%20Study/GHG3%20Executive%20Summary%20and%20Report.pdf> (accessed 20 November 2019).
- International Maritime Organization (IMO), 2014b. Marine Environment Protection Committee (MEPC). Resolution MEPC.245(66), London, UK, <http://www.imo.org/en/KnowledgeCentre/IndexofIMOResolutions/Marine-Environment-Protection-Committee-%28MEPC%29/Documents/MEPC.245%2866%29.pdf> (accessed 04 December 2019).
- International Maritime Organization (IMO), 2016. Methanol as marine fuel: Environmental benefits, technology readiness, and economic feasibility, <http://www.imo.org/fr/OurWork/Environment/PollutionPrevention/AirPollution/Documents/Report%20Methanol%2021.01.2016.pdf> (accessed 02 December 2019).
- International Maritime Organization (IMO) 2018a. Marine Environment Protection Committee (72nd session), <http://www.imo.org/en/MediaCentre/MeetingSummaries/MEPC/Pages/Default.aspx> (accessed 20 November 2019).
- International Maritime Organization (IMO), 2018b. Data Collection System on fuel consumption. <http://www.imo.org/en/OurWork/Environment/PollutionPrevention/AirPollution/Pages/Data-Collection-System.aspx> (accessed 02 December 2019).
- Ionescu R.D., Szava I., Vlase S., Ivanoiu M., Munteanu R., 2015. Innovative solutions for portable wind turbines, used on ships. *Procedia Technology*. 19, 722-729.
- Klebanoff L.E., Pratt J.W., Leffers C.M., Sonerholm K.T., Escher T., Burgard J., Ghosh S., 2017. Comparison of the greenhouse gas and criteria pollutant emissions from the SF-BREEZE high-speed fuel-cell ferry with diesel ferry. *Transportation Research Part D*. 54, 250-268.
- Ling-Chin J., Heindrich O., Roskilly A.P., 2016. Life cycle assessment (LCA)-from analysing methodology development to introducing an LCA framework for marine photovoltaic (PV) systems. *Renewable and Sustainable Energy Reviews*. 59, 352-378.

- Monteiro A., Russo M., Gama C., Borrego C., 2018. How important are maritime emissions for the air quality: At European and national scale. *Environmental Pollution*. 242, Part A, 565-575
- Odeh N.A., Cockerill T.T., 2008. Life cycle GHG assessment of fossil fuel power plants with carbon capture and storage. *Energy Policy*. 36 (1), 367-380.
- Perry S., Klemeš J., Bulatov I., 2008. Integrating waste and renewable energy to reduce the carbon footprint of locally integrated energy sectors. *Energy*. 33 (10), 1489-1497.
- Raymond L., 2019. Policy perspective: Building political support for carbon pricing—Lessons from cap-and-trade policies. *Energy Policy*. 134, 110986.
- Rico A., Martínez-Blanco J., Montlleó M., Rodríguez G., Tavares N., Arias A., Oliver-Solà J., 2019. Carbon footprint of tourism in Barcelona. *Tourism Management*. 70, 491-504.
- Rugani B., Vázquez-Rowe I., Benedetto G., Benetto E., 2013. A comprehensive review of carbon footprint analysis as an extended environmental indicator in the wine sector. *Journal of Cleaner Production*. 54, 61-77.
- Runko Luttenberger L., Ančić I., Šestan A., 2013. The viability of short-sea shipping in Croatia. *Brodogradnja*. 64, 472-481.
- Schinas O., Butler M., 2016. Feasibility and commercial considerations of LNG-fueled ships. *Ocean Engineering*. 122, 84-96.
- Sharafian A., Blomerus P., Mérida W., 2019. Natural gas as a ship fuel: Assessment of greenhouse gas and air pollutant reduction potential. *Energy Policy*. 131, 332–346.
- Sofiev M., Winebrake J.J., Johansson L., Carr E.W., Prank M., Soares J., Vira J., Kouznetsov R., Jalkanen J., Corbet J.J., 2018. Cleaner fuels for ships provide public health benefits with climate tradeoffs. *Nature Communications*. 9 (1). doi: 10.1038/s41467-017-02774-9.
- Statistical Yearbook of the Republic of Croatia (SYRC), 2018 https://www.dzs.hr/Hrv_Eng/ljetopis/2018/sljh2018.pdf (accessed 04 December 2019).
- Stiglitz J.E., Stern N., Duan M., Edenhofer O., Giraud G., Heal G., Lèbre la Rovere E., Morris A., Moyer E., Pangestu M., Shukla P.R., Sokona Y., Winkler H., 2017. Report of the High-Level Commission on Carbon Prices. World Bank, Washington, DC.
- Svanberg M., Ellis J., Lundgren J., Landälv I., 2018. Renewable methanol as a fuel for the shipping industry. *Renewable and Sustainable Energy Reviews*. 94, 1217-1228.

- Synapse. Spring 2016 National Carbon Dioxide Price Forecast, 2016 <http://www.synapse-energy.com/sites/default/files/2016-Synapse-CO2-Price-Forecast-66-008.pdf> (accessed 12 December 2019).
- Thomson H., Corbett J.J., Winebrake J.J., 2015. Natural gas as a marine fuel. *Energy Policy*. 87, 153-167.
- Torbianelli V.A., 2000. When the road controls the sea: a case study of Ro-Ro transport in the Mediterranean. *Maritime Policy & Management*. 27 (4), 375-389.
- Trivyza N.L., Rentizelas A., Theotokatos G., 2019. Impact of carbon pricing on the cruise ship energy systems optimal configuration. *Energy*. 175, 952-966.
- Tsitsilonis K. M., Theotokatos G., 2018. A novel systematic methodology for ship propulsion engines energy management. *Journal of Cleaner Production*. 204, 212-236.
- Tvinnereim E., Mehling M., 2018. Carbon pricing and deep decarbonisation. *Energy Policy*. 121, 185-189.
- United Nations Framework Convention Climate Change (UNFCCC), Climate Change Information kit, 2001. <https://unfccc.int/resource/iuckit/cckit2001en.pdf> (accessed 15 November 2019).
- van Biert L., Godjevac M., Visser K., Aravind P.V.: A review of fuel cell systems for maritime applications. *Journal of Power Sources*, Vol. 327, 2016, pp. 345-364.
- Wan Z., El Makhoulfi A., Chen Y., Tang J., 2018. Decarbonizing the international shipping industry: Solutions and policy recommendations. *Marine Pollution Bulletin*. 126, 428-435.
- Wicker P., 2019. The carbon footprint of active sport participants. *Sport Management Review*, 22 (4), 513-526.
- Wiedmann T., Minx J., 2008. A Definition of Carbon Footprint. In: Pertsova C.C., *Ecological Economics Research Trends: Chapter 1*. Nova Science Publishers, Hauppauge NY, 1-11.
- Woo J.-K., Moon D.S.-H., 2014. The effects of slow steaming on the environmental performance in liner shipping. *Maritime Policy & Management*. 41 (2), 176-191.
- World Register of Ships (WROS) database, 2013. IHS FAIRPLAY.
- Xie L., Xue Q., Yuan Z., 2019. Composition and spatial difference of agro-industry carbon footprint in Hebei province, North China. *Ecological Indicators*. 97, 141-149.

- Yan Y., Zhang H., Meng J., Long Y., Zhou X., Li Z., Wang Y., Liang Y., 2019. Carbon footprint in building distributed energy system: An optimization-based feasibility analysis for potential emission reduction. *Journal of Cleaner Production*. 239, 117990. <https://doi.org/10.1016/j.jclepro.2019.117990>.
- Yu M., Wiedmann T., Crawford R., Tait C., 2017. The Carbon Footprint of Australia's Construction Sector. *Procedia Engineering*. 180, 211-220.
- Yu W., Zhou P., Wang H., 2018. Evaluation on the energy efficiency and emissions reduction of a short-route sightseeing ship. *Ocean Engineering*. 162, 34-42.
- Yuan Y., Wang J., Yan X., Li Q., Long T., 2018. A design and experimental investigation of a large-scale solar energy/diesel generator powered hybrid ship. *Energy*. 165, Part A, 965-978.
- Zaninović K., Gajić-Čapka M., Perčec Tadić M., 2008. *Climate atlas of Croatia 1961-1990., 1971-2000*. Croatian Meteorological and Hydrological Service, Zagreb, Croatia.

ARTICLE 2

Preprint of the published journal article.

Life-cycle cost assessments of different power system configurations to reduce the carbon footprint in the Croatian short-sea shipping sector

Maja Perčić, Ivica Ančić, Nikola Vladimir*

University of Zagreb, Faculty of Mechanical Engineering and Naval Architecture, Ivana Lučića 5, 10000 Zagreb, Croatia

Abstract

In order to comply with stringent environmental regulations, shipbuilders and ship-owners are seeking cleaner fuels and the integration of renewable energy sources into ship power systems. Such solutions regularly result in additional costs for ship operators, both in the case of retrofitting existing ships or acquiring completely new vessels. This paper deals with the life-cycle cost assessments (LCCAs) of different power system configurations of a ro-ro passenger vessel operating in the Croatian short-sea shipping sector. Electrification of the ship is considered as an option to reduce the carbon footprint (CF) of the vessel and to achieve economic savings during its lifetime. In this sense, the ship operational profile is analysed and its total power needs are determined. The life-cycle assessments of an existing diesel engine-powered solution and two potential battery-powered ship options (with and without photovoltaic cells) are performed by means of GREET 2018 software. Furthermore, these options are compared from an economical viewpoint, where different carbon credit scenarios are investigated. The results show that a diesel engine-powered vessel has the highest carbon footprint, as expected. However, it is also found that a battery-powered vessel (with or without photovoltaic cells) has a minimum environmental footprint and at the same time represents economically the most favourable solution for all possible carbon allowance scenarios. This indicates that all-electric ships seem to be a promising option for the future development of the Croatian short-sea shipping sector.

* Corresponding author on: tel.: +38516168114; email address: nikola.vladimir@fsb.hr (N. Vladimir).

Keywords: short-sea shipping; LCCA; CO₂ emission; carbon credit; ship power source, all-electric ship.

Word Count: 8844

Highlights:

- The applicability of different power sources in short-sea shipping is investigated
- LCAs and LCCAs of different power options for ro-ro vessels are performed
- The influence of carbon credit policies in the marine sector is considered
- The electrification of the Croatian ro-ro fleet is a viable option to reduce the CF

Nomenclature

Variables

<i>A</i>	area (m ²)
<i>E_{rad}</i>	annual solar irradiation (MJ/m ²)
<i>P</i>	power (kW)
<i>SFC</i>	specific fuel oil consumption (g/kWh)
<i>t</i>	operational time (h)
<i>v</i>	ship speed (kn)

Greek symbols

η	efficiency (-)
--------	----------------

Subscripts

<i>80% MCR</i>	80% maximum continuous rating
<i>ave</i>	Average
<i>PV</i>	photovoltaic system

Abbreviations

CF	Carbon Footprint
CP	Current Policy
GHG	Green-House Gas
GWP	Global Warming Potential
IMO	International Maritime Organization
LCA	Life-Cycle Assessment
LCC	Life-Cycle Cost
LCCA	Life-Cycle Cost Assessment
NP	New Policy
NT	Non-Taxation
PTW	Pump-To-Wheel
PV	Photovoltaic
SD	Sustainable Development
WTP	Well-To-Pump
WTW	Well-To-Wheel

1. Introduction

1.1. Regulatory framework for energy efficiency and the environmental footprint in the shipping sector

Nowadays, ship energy efficiency and the effect of marine transportation on the maritime environment have become very important issues for all parties involved in the shipping sector, i.e. shipbuilders, ship-owners, public authorities, policy makers, etc. Marine exhaust gases from the combustion of fuel in engines can be considered one of the major causes of marine environment pollution. The most pernicious emissions released from internal combustion engines are carbon monoxide (CO), carbon dioxide (CO₂), sulphur oxides (SO_x), nitrogen oxides (NO_x) and particulate matter (PM₁₀). Greenhouse gases (GHGs) in the atmosphere cause the greenhouse effect, which leads to the warming of the Earth's surface and has an impact on various climate changes. These GHG emissions refer to emissions of CO₂, methane (CH₄), nitrous oxide (N₂O) and fluorinated gases [1].

Different regulations, such as the Kyoto Protocol of 1997 [2], have been introduced to control GHG emissions at the global level. The most recent climate agreement is the Paris Agreement, adopted in 2015, with the key aim to keep the global temperature rise this century well below 2 °C above pre-industrial levels and even to limit the temperature increase to 1.5 °C [3].

Carbon footprint (CF) assessment is widely recognized as a relevant approach to quantifying GHG emissions. According to [4], the CF represents a measure of the total amount of CO₂ emissions directly and indirectly caused by an activity or accumulated over the life stages of a product and is regularly expressed in tons of CO₂ or in tons of CO₂ equivalent (CO₂-eq). Nowadays, CF assessment and procedures to reduce the CF are among the research topics that are attracting most interest in almost all types of human activity, such as civil engineering [5], the communication sector [6], agriculture [7], etc. The carbon footprint is regularly assessed as a result of life-cycle analysis (LCA), which provides a quantification of emissions through the whole life cycle of a specific product [8].

Marine transportation offers many advantages and can be considered as the cheapest and the most energy efficient way of transporting large amounts of cargo [9]. According to the International Maritime Organization (IMO), in 2012 global shipping emitted about 1,016 million tons of CO₂ which represents nearly 3.1% of global CO₂ emissions [10]. However, if no actions are taken, these emissions are expected to increase from the 2012 levels by 50-250%

by 2050. In addition, these emissions are highly correlated to fuel consumption, as well as other emissions to air (NO_x, SO_x and PM₁₀). Even though the overall CO₂ emission from the shipping industry is quite low on a global scale, the UN stance is that every industry has to contribute to the reduction of global GHG emissions.

This is recognized by the International Maritime Organization (IMO) which adopted a new regulation on energy efficiency for ships in 2011 [11]. Control of ship engine emissions is regulated by MARPOL Annex VI, [12], which was first adopted in 1997, limiting the main air pollutants contained in exhaust gases, such as SO_x and NO_x, prohibiting intentional emissions of ozone depleting substances, as well as regulating shipboard incineration and emissions of organic compounds from tankers [13]. MARPOL Annex VI has been revised and amended on many occasions, and nowadays includes two sets of emission and fuel quality requirements: global requirements, and requirements applicable to ships in Emission Control Areas (ECAs), as explained in [13]. Regarding SO_x emissions, MARPOL Annex VI prescribes the maximum percentage of sulphur content in marine fuel, where different levels are allowed within ECAs and globally, as listed in [13]. Some other measures to reduce sulphur emissions are also allowed, such as the use of exhaust gas cleaning systems. NO_x emission limits are set for diesel engines depending on the engine maximum speed, where we distinguish Tier I, Tier II, and Tier III standards, respectively. The Tier I and Tier II limits are global, while the Tier III standards apply only in NO_x ECAs. It should be mentioned that there are no specific particulate matter emission regulations, but their levels are regulated indirectly within fuel standards.

A new regulation introduced in 2011 [11] requires every ship of GT=400 and above engaged in international shipping to have the International Energy Efficiency (IEE) Certificate. In order to obtain it, the ship has to comply with the requirements of the Energy Efficiency Design Index (EEDI) and the Ship Energy Efficiency Management Plan (SEEMP). The EEDI is a technical measure and requires that for every new ship the Attained EEDI must be calculated and must not exceed the Required EEDI, which is defined by the EEDI reference line value and the appropriate reduction factor X . The reduction factor is defined in a set of time intervals, roughly 10% reduction every 5 years. The EEDI reference line should represent the average ship energy efficiency of the current fleet, whilst the reduction factor should represent a requirement for new ships to improve their energy efficiency compared to the status of the current fleet [14]. The SEEMP must be developed for a ship according to the Guidelines and must be kept on board [11].

Although the EEDI does not fundamentally represent a carbon footprint reduction measure, one should not ignore its origin in the so-called CO₂ Index, also introduced by the MEPC. In spite of renaming it EEDI, it still represents relative CO₂ emissions, i.e. the ratio of CO₂ emissions per ton and nautical mile of cargo transported [15], and, as elaborated by Traut et al. [16], the aim of these requirements is to regulate CO₂ from the shipping industry. Several guidelines have been issued to ensure the smooth and uniform implementation of EEDI and SEEMP, as for instance [17] and [18], but the literature review indicates a number of weaknesses of the current legislation and difficulties in its practical application. As elaborated in [9], the current EEDI regulations do not properly consider that the market of container ships has changed radically in the last decade, where the number of ultra-large container vessels has increased. These ships satisfy the EEDI requirements very easily (due to their large capacity and relatively high operating speed) and there is practically no regulation encouraging improvements in their energy efficiency. A very significant drawback of the existing EEDI regulations is the fact that only one operating point, defined by design speed, is considered as relevant [14]. However, in real ship operations, this speed is very seldom achieved. This is particularly the case for ships involved in short-sea shipping, such as ro-ro passenger vessels that change their operating profile frequently. For some ship types like bulk carriers, the EEDI reduction factors are set too rigidly [15]. In its current form, the EEDI regulations are not applicable to complex power systems such as integrated or hybrid ones [19]. Generally, the EEDI is highly sensitive to the ship design speed [20], and, as discussed in [21], the EEDI baseline does not seem to be properly set for some ship types. Finally, there are several gaps in the SEEMP guidelines compared with the international standard for energy management systems [22]. Overall, both the EEDI and the SEEMP requirements will have an impact on the energy efficiency of ships, but one that is not sufficiently high [23].

1.2. Improvements in the ship power system to reduce GHG emissions

The overall goal to improve energy efficiency and to reduce the environmental effect of shipping can be achieved through a set of technical (EEDI-related) and operational (SEEMP-related) measures. In general, the technical measures to reduce the carbon footprint used in the shipping sector are: measures related to the propulsion system, vessel design and vessel equipment, exhaust after treatment, engine internal measures, use of alternative fuel/energy (LNG, electricity, hydrogen, biofuel), while the set of operational measures includes: measures related to speed reduction, smart steaming, journey planning, on-board information systems,

and optimal maintenance. In addition, measures related to the organization of the logistical chain, to the interface between inland ships and other transport modes, and to the interface of ships and infrastructure (locks, terminals and seaports, etc.) should also be mentioned.

With the aim to increase the energy efficiency of ships, conventional energy systems (diesel-mechanical propulsion) can be replaced by an alternative hybrid (HPS) or an integrated power system (IPS), with reduced pollutant emissions as a consequence. The HPS is characterized by the use of different types of power sources, while the main characteristic of the IPS is centralized electric power generation and the application of electric propulsion. For example, Ančić et al. [19] proved that ro-ro passenger ships with IPS or HPS are more energy efficient compared to the fleet average which uses mechanical propulsion. Many studies have shown that pollutant emissions can be reduced by using renewable power resources such as the sun and wind for power generation on board. For example, Klebanoff et al. [24] showed how a hybrid high-speed fuel-cell ferry can reduce GHG emissions. Yu et al. [25] presented a hybrid electric power system for sightseeing vessels designed for short sailing, consisting of four-stroke diesel generators, solar panels and Li-ion batteries. CO₂ emissions have been dramatically reduced in hybrid energy systems compared with conventional systems. Another example of HPS implemented on a ship was designed by Diaz-de Baldasano et al. [26] as innovative hybrid diesel electric-fuel cell propulsion. Two high-temperature solid oxide fuel cell (SOFC) systems using methanol as a fuel were integrated on a ship and the result was the reduced emission of GHG. Ahn et al. [27] investigated a marine generator fuel cell-gas turbine hybrid system in terms of energy efficiency and environmental impact in very large ethane carriers. The general conclusion from the above references is that hybrid systems using renewable energy sources and alternative fuels and technologies increase energy efficiency and reduce the environmental footprint of ships. However, costs still remain an issue.

Due to environmental regulations and the depletion of fossil fuels, the electrification of ships represents a very important research topic. Gagatsi et al. [28] presented a fully electrified ferry as a new paradigm in short-sea shipping. So far, typical battery-powered ro-ro passenger ships could use batteries as the main power source on short trips and they could be charged whilst connected to shore power. The great advantage of this kind of ship is that it produces zero emissions during navigation.

1.3. The aim of the paper

From the above literature review, the following research gap is evident: there is no unified approach to the design of a ship power system which should simultaneously comply with energy efficiency and environmental regulations at a reasonable price. The integration of renewable energy sources in the ship power system is a rather case-specific task which should be performed for each vessel separately, simultaneously taking into account its technical characteristics and operating profile (highly dependent on the navigation area).

The aim of this paper is therefore to investigate the applicability of different power system configurations for the reduction of the CF that can be implemented on board a ro-ro passenger ship engaged in short-sea shipping in the Croatian part of the Adriatic Sea. Through the life cycle cost assessment (LCCA) of these power system options, the most environmental and economical solution for retrofitting this kind of ship is highlighted.

The contribution of this study is summarized as follows: (a) the development of a model to calculate the CF of a Croatian ro-ro passenger ship that operates in the Adriatic Sea; (b) the determination of the most economical and ecological power system configuration for retrofitting the same ship.

This paper is structured into five sections. In the next section the LCAs of different power system configurations for Croatian ro-ro passenger ship are elaborated in detail. The third section contains the LCCA of selected energy power systems, while the fourth section is dedicated to a discussion of the performed assessments. Finally, concluding remarks are drawn in the fifth section.

2. The LCA of ship power system configurations

2.1. Theoretical background of LCA

According to the International Organization for Standardization (ISO 14040) [29], LCA is a method to investigate the environmental impacts of a product throughout its life cycle, which includes:

- Raw material;
- Production or manufacturing;
- Use of product;
- End of life treatment;
- Recycling and final disposal.

In this paper, a number of LCAs are performed by means of GREET 2018 software. Processes of raw material recovery, the production of a power source and its supply to the vessel are referred to as “Well-to-Pump” (WTP), while WTP processes and the use of the power source in vessel operations are termed as “Well-to-Wheel” (WTW), Figure 1. Vehicle operations are referred to as “Pump-to-Wheel”, or, in the case of a ship, “Pump-to-Propeller”.

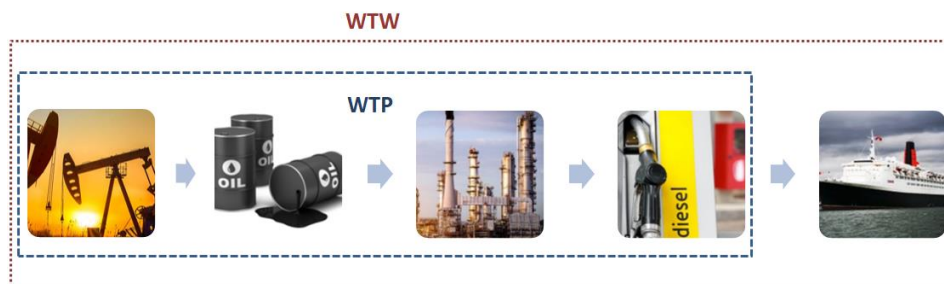

Figure 1 WTW and WTP display of diesel engine-powered ship

The results of the performed LCAs are emissions released during the life cycle of power system configurations and are presented in units of CO₂-eq.

2.2. Ship energy needs and particulars

The considered ro-ro passenger ship operates in the Croatian short-sea shipping sector, Figure 2, and its main particulars are:

- Length overall: 99.8 m
- Length between perpendiculars: 89.1 m
- Breadth: 17.5 m
- Draught: 2.4 m
- Deadweight at max. draught: 950 t
- Design speed: 12.5 kn

The vessel is equipped with four Volvo Penta main engines with a maximum continuous rating (MCR) of 450 kW each. More data on the vessel can be found in [30]. Its design speed is 12.5 knots at 80% MCR (1440 KW), and its loading capacity yields 600 passengers and 145 standard cars. The distance that the ship sails during one round trip is 16.3 nm and the number of round trips per year is 1,740 [31].



Figure 2 Ro-ro passenger ship in operation [32]

This ferry operates on a route connecting two parts of the Croatia mainland in the southern part of the country, i.e. the port of Ploče and the port of Trpanj, with a length of 8.15 nm and an average duration of a one-way trip of 60 minutes. Excluding manoeuvrings in ports, it is assumed that the ship sails for around 50 min, so the effective calculated average speed of the ferry on that route is 9.8 knots. Since the ship power is roughly proportional to the cube of its speed, the average ship power on that route was calculated according to the following expression:

$$P_{ave} = P_{80\%MCR} \cdot \left(\frac{v_{ave}}{v_{80\%MCR}} \right)^3 \quad (1)$$

The calculated average ship main power is 694 kW. To determine the total power requirements, the power for auxiliary purposes needs to be added. There are two auxiliary diesel engines on board rated at 360 kVA each, regularly operating at 50% of MCR. With the power factor assumed to be 0.85, the required electric power for the ship auxiliary system is 308 kW. Assuming that the efficiency of the electric generator is 95%, the total output of these engines is then 324 kW. By summing up the auxiliary engines' power and the main engines' power, the total power of the ship was calculated at 1,018 kW. Taking into account the average speed, the energy consumption is estimated at 104 kWh/nm. The fuel consumption of the ship was calculated by multiplying the energy consumption with the specific fuel consumption (SFC). The SFC is determined depending on the engine speed, as proposed by Ančić et al.[20], i.e. for medium speed engines, the SFC is assumed to be 180 g/kWh, while for high speed engines the SFOC yields 215 g/kWh, which is used in this assessment. The fuel consumption of this ship on the Ploče-Trpanj route is then 22.36 kg/nm.

The selected power system configurations for the implementation of the test on a ro-ro passenger vessel are battery and photovoltaic (PV) cells. In order to compare different power options on board, first it is necessary to perform the LCA and cost assessment of the existing ship power system, i.e. the diesel engine.

2.3. The LCA of a diesel engine-powered ship

In order to assess the total GHG emissions released during the life cycle of diesel fuel, the emissions from all processes need to be summed up. These processes include crude oil recovery, the transportation of crude oil, diesel refining, diesel distribution and, finally, the use of diesel on the ship which results in tailpipe emissions, Figure 3. Tailpipe emissions from diesel combustion in a marine engine are calculated by multiplying ship fuel consumption with the emission factors, as prescribed in [33]. In order to evaluate the contribution to the greenhouse effect from each of the GHGs, the global warming potential (GWP) has been developed and represents a measure of how much energy the emissions of one ton of a gas will absorb over a given period of time, relative to the emissions of one ton of CO₂. The time range usually used is 100 years and, typically, GHGs are reported in units of CO₂-eq [34].

The production of domestic crude oil in Croatia is performed on exploitation fields in the continental part of the country. In addition to domestic production, Croatia also imports crude oil, primarily from Azerbaijan, Iraq and Kazakhstan [35]. Some specific data that were missing in the case of Croatia in the process of crude oil recovery were taken from the GREET 2018 database (Conventional Crude Recovery process) for the needs of this investigation. Crude oil is transported to the refinery. It is considered here that the crude oil is imported from the Middle East and transported via tankers and pipelines to Croatia. From the offshore terminal on the island of Krk, crude oil is then transported through the oil pipeline system to the oil refineries. For this assessment, for reasons of simplicity, it is assumed that diesel is produced only in the refinery in Rijeka. The length of the oil pipeline from the offshore terminal to this refinery is 7 km [35]. After transportation, the crude oil is refined in a stationary process. The parameters of the diesel refining process are obtained from the GREET 2018 database.

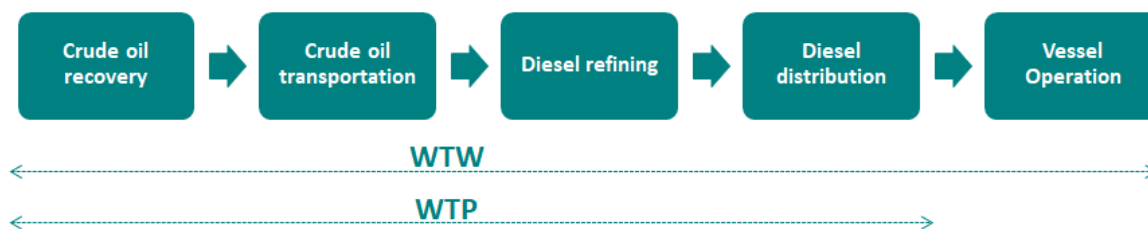

Figure 3 Life cycle of a diesel engine-powered ship configuration

After the diesel is produced, it is distributed by tank trucks to gas stations. Tank trucks transport diesel 450 km to the gas station in the port of Ploče, from where the ship sails towards Trpanj. The previously determined ship energy need is 104 kWh/nm, while the consumption of diesel is 22.36 kg/nm. The calculated tailpipe emissions are presented in Table 1.

Table 1 Calculated tailpipe emissions from the diesel engine-powered ship

Tailpipe emissions	
CO ₂	71.69 kg CO ₂ /nm
CH ₄	0.42 g CH ₄ /nm
N ₂ O	3.17 g N ₂ O/nm

According to the LCA, the diesel engine-powered ship, through the life cycle of diesel, emits 79.74 kg CO₂-eq/nm. The ship's operation contributes the main share of the total emissions of GHG with 72.64 kg CO₂-eq/nm, while the WTP GHG emissions, Figure 4, are 7.10 kg CO₂-eq/nm. The process of refining diesel contributes the most GHGs. The annual CF related to navigation is 2,060 tons.

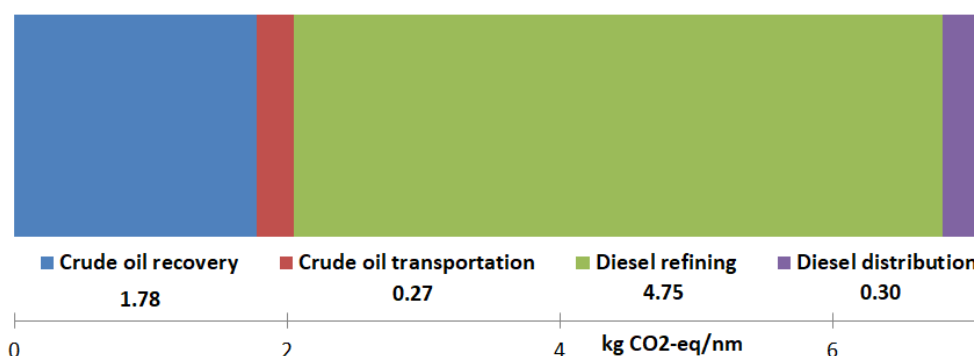

Figure 4 WTP GHG emissions of diesel

2.4. LCA of a battery-powered ship

The second power system configuration represents a Li-ion battery installed on board. Even though Li-ion batteries are quite expensive, they have by far the highest energy density compared to other types of batteries [36], and they are most prominent in shipping applications. The WTP assessment of electricity includes generation, transmission and distribution. The main types of energy sources are shown in Figure 5, with the exception of nuclear energy whose production does not exist on the territory of Croatia. A more detailed breakdown of individual energy sources is provided in Figure 6 [37].

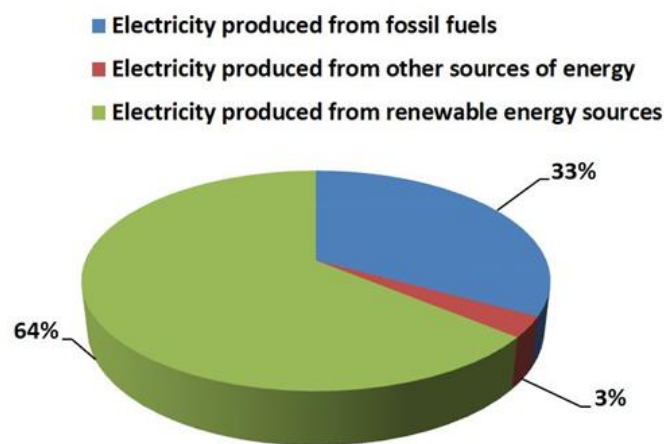

Figure 5 Shares of individual energy sources in total produced electricity in Croatia [37]

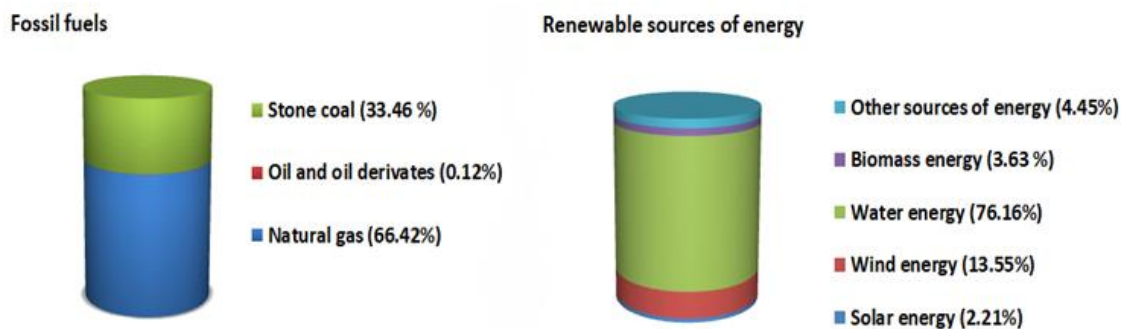

Figure 6 Energy sources for electricity generation in Croatia divided into fossil fuels and renewable sources of energy [37]

The WTP of electricity, the process of battery manufacturing, and ro-ro passenger ship operation constitute the whole life cycle of the power source for a battery-powered ship, Figure 7.

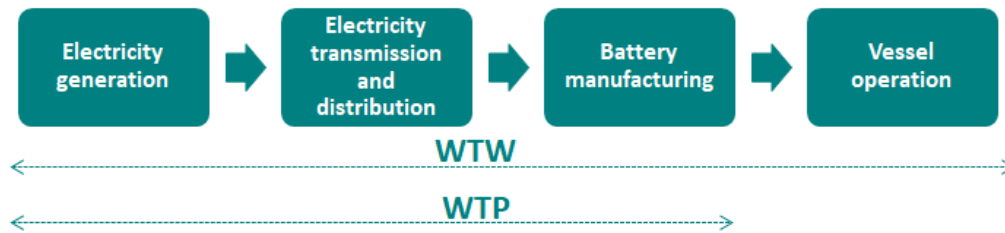

Figure 7 Life cycle of a battery-powered ship configuration

A battery-powered ship is supplied with power by the on-board battery only. The ship power needs are defined in section 2.2. It is assumed that the ship has two propellers driven by two electric motors. It is also assumed that the propulsion and the auxiliary power system needs remain unchanged. Due to the losses in the electric motor and the electric power distribution, the required power for the propulsion system supplied by the battery is increased by 10% and equals 759 kW. Electric power for the auxiliary system is 308 KW as determined in section 2.2. The total power output of the battery is 1,067 kW. Taking into account that the average speed of the ship is 9.8 knots, the energy consumption is 109 kWh/nm.

It is assumed that this battery would have to power the ship during a round trip (from Ploče to Trpanj and back from Trpanj to Ploče). The minimum required capacity is 1780 kWh. Due to the safety margin, this value is doubled and amounts to 3600 kWh. The typical power density of a Li-ion battery is around 0.254 kWh per kg. Knowing these data, the weight of the battery was easily calculated at around 14 tons.

According to the assessment, a battery-powered ship through its life cycle emits 27.92 kg of CO₂-eq/nm. During operation, a battery-powered ship does not have emissions, but during the production of the battery and electricity generation (in the case of Croatia), different emissions are released and taken into account for the total amount of GHG emissions. The results in Figure 8 represent the WTP GHG emissions from the electricity life cycle (23.60 kg CO₂-eq/nm). It is assumed that the processes of electric power generation by using water, wind and solar energy are emission free. The processes that contribute the most to GHG emissions are the generation of electricity from natural gas and coal.

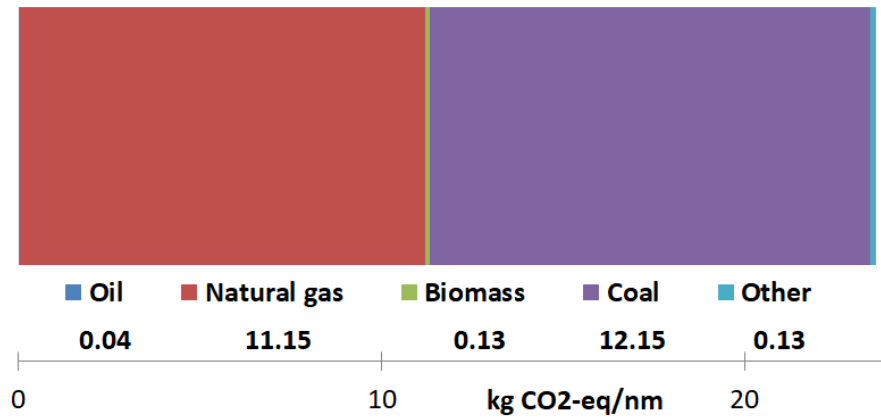

Figure 8 WTP GHG emissions of electricity

Emissions released from the process of battery manufacturing are equal to 4.32 kg CO₂-eq/nm. WTW GHG emissions from a battery-powered ship are presented in Figure 9.

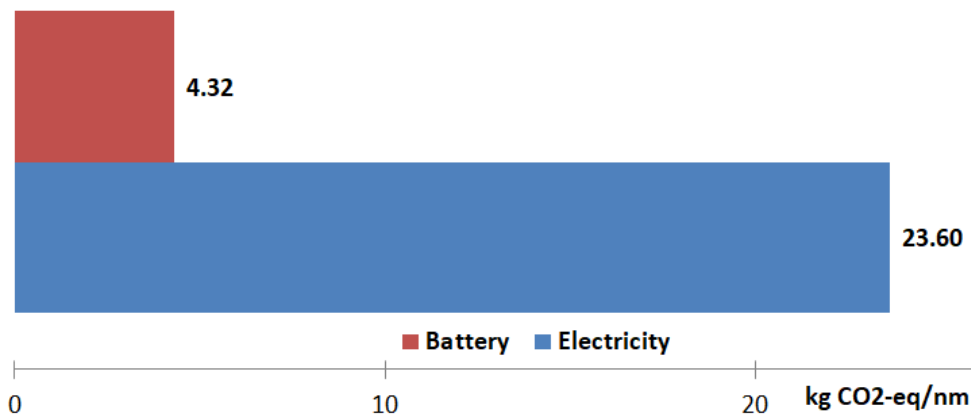

Figure 9 WTW GHG emissions of a battery-powered ship

2.5. PV cells battery-powered ship

The third power system configuration represents the PV cells battery-powered ship, where, on board the previously analysed battery-powered ship, a PV system is installed. A PV system is powered by PV modules, which contain many individual PV cells that are interconnected to form a PV module. For the purpose of a PV system on board a ro-ro passenger ship, an off-grid PV system needs a rechargeable battery such as a Li-ion battery to store electricity for use under conditions where there is little or no output from the PV system, for example on a cloudy day or at night [38]. Usually, the PV cells are placed on the ship top deck so as not to disturb the passengers, the crew and the ship functions. Hence, the total area covered by the PV cells is limited by the ship's main deck dimensions. Since the ship sails in

different directions, it is also not possible to align the PV cells directly with the sun. Instead, they are placed horizontally which then reduces the efficiency of the PV cells.

The advantage of PV cells is that they can directly transform solar power into electric power, but their efficiency is relatively low. For this assessment, the data on the efficiency of PV cells (17%) is obtained from a study by Liu et al. [39]. It should also be noted that many PV cell manufacturers provide a warranty for 20 years. Therefore, for this assessment, the life span of PV cells is 20 years.

The LCA of this ship power system configuration takes into account the emissions from the electricity generation process and from the manufacturing processes of the Li-ion battery and the PV module materials, Figure 10.

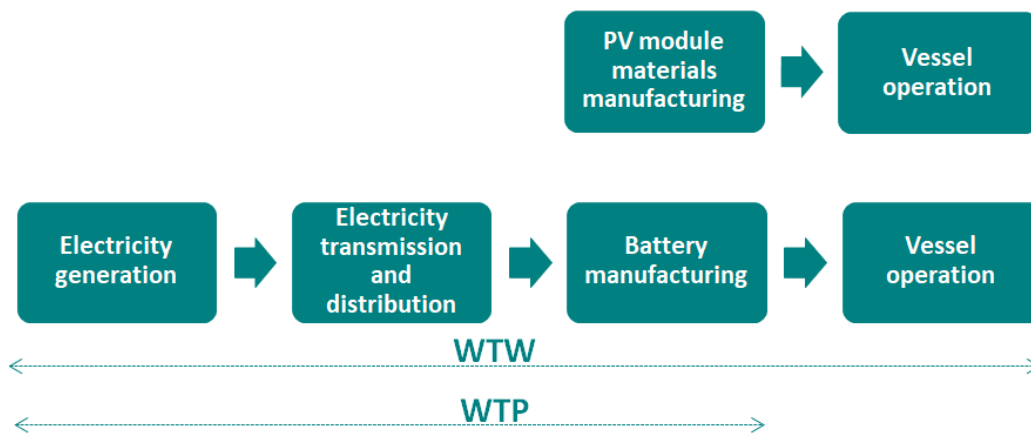

Figure 10 Life cycle of PV cells battery-powered ship configuration

For the area of navigation, the average annual solar irradiance, obtained from the Climate Atlas of Croatia [40], is 5557 MJ/m² for horizontally placed cells and 6109 MJ/m² for cells aligned at 45°. Since the PV cells are limited to horizontal placement on board, the data for horizontal cells are used. As mentioned previously, the length between perpendiculars is 89.1 m and the ship breadth is 17.5 m. Therefore, the available length for the installation of PV cells is around 60 m, while the available width is 15 m, resulting in the available area estimated at around 900 m². The total annual electric energy produced on this route is:

$$E_{PV} = \eta_{PV} \cdot E_{rad} \cdot A = 0.17 \cdot 5557 \cdot 900 = 850.2 \text{ GJ} . \quad (2)$$

In one year, the ship performs 1,740 round trips. Since the duration of a round trip is 100 minutes, in total the ship sails for 2,900 hours annually. This would amount to an average electric power of:

$$P_{PV} = \frac{E_{PV}}{t} = \frac{850.2 \cdot 10^9}{2,900 \cdot 3600} = 81.4 \text{ kW} . \quad (3)$$

The required power is the same as for the battery-powered ship explained in section 2.4, therefore 1,067 kW, where 81.4 kW is obtained from the PV system and 985.6 kW from the Li-ion battery. The energy consumption of the ship remains the same and amounts to 109 kWh/nm.

Crystalline silicon (c-Si) cells are used due to their low cost, high density and efficiency. They are also more appropriate for use on horizontal surfaces than thin-film PV cells [41]. By weight, c-Si PV panels today contain about 76% glass for the panel surface, 10% polymer (foil), 8% aluminium for the frame, 5% silicon for the PV cells, and 1% copper for the interconnectors [42]. According to some commercial c-Si PV panels [43], the dimension of a module is 1.64 m², where the module weight is 19.5 kg and includes about 60 c-Si cells. In order to cover the available area with PV panels (900 m²), the PV system contains 548 modules with a total weight of 10.7 tons. Since the share of material of c-Si in the PV module is 5%, the weight of the c-Si PV cells is calculated to amount to 534.5 kg. Besides silicon, for this LCA, aluminium, copper and glass are included as material for the PV application, and data on these manufacturing processes are obtained from the GREET 2018 database.

According to the LCA, through its life cycle the PV cells battery-powered ship emits 31.98 kg CO₂-eq/nm. The emissions released from the processes of electricity generation and the manufacturing of the Li-ion battery and the PV module materials are taken into account. The WTW emissions of this ship are presented in Figure 11. The process of electricity generation makes the highest contribution with 21.81 kg CO₂-eq/nm, while the processes of manufacturing the battery and the PV module materials contribute 4.32 kg CO₂-eq/nm and 5.85 kg CO₂-eq/nm.

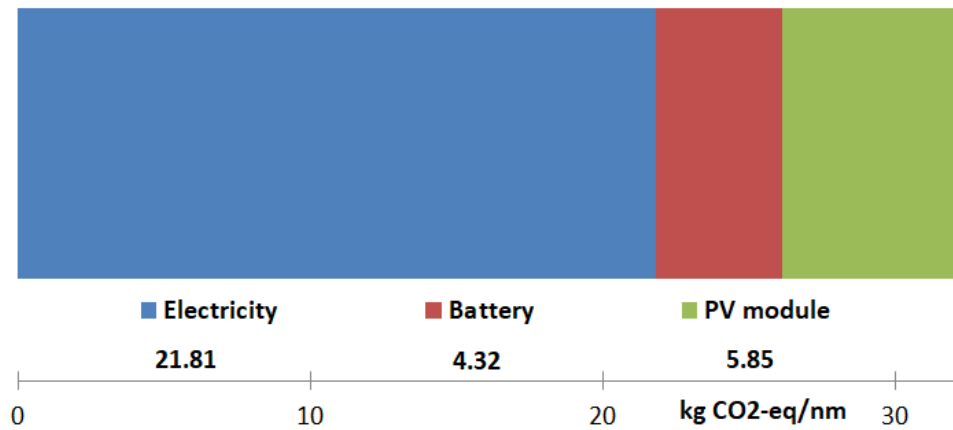

Figure 11 WTW GHG emissions of a PV cells battery-powered ro-ro passenger ship

3. The LCCA of ship power system configurations

3.1. Theoretical background of the performed LCCA

LCCAs of different power system configurations implemented on a ro-ro passenger vessel are performed. The results of the total LCCA refer to costs during the life span of the ship, i.e. 20 years. The total costs of the ship power system configuration include investment (capital) costs and exploitation costs, Figure 12. Maintenance costs, power source costs and carbon credit costs are accounted for in the exploitation costs.

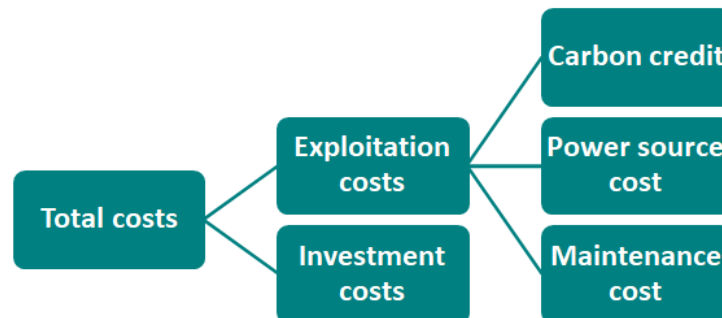

Figure 12 Total costs of a ship power system configuration

Investment costs refer to the additional investment costs of the power system configuration since the diesel engine-powered ro-ro passenger ship already exists, while the maintenance costs refer to the costs of maintenance and replacement of some parts of the power system configuration. Within exploitation costs, carbon credit is also added.

Carbon pricing can play an important role in providing an economically efficient incentive to reduce GHG emissions [44], [45]. Even though carbon pricing has not yet been implemented in the shipping industry, but is the subject of very recent investigations [46], some sectors have already implemented it (industry, aviation, the electric power sector, etc.). Companies receive or buy emission allowances which they can trade with one another as needed. Each allowance gives the holder the right to emit 1 ton of CO₂, the main GHG, or the equivalent amount of two more powerful GHGs, N₂O and perfluorocarbons (PFCs). At the end of each year, a company must hand over enough allowances to cover all its emissions, otherwise heavy fines are imposed. If a company reduces its emissions, it can keep the spare allowances to cover its future needs or else sell them to another company [47].

For the implementation of carbon allowances, known as carbon credit, in the shipping industry, a system to track the emissions of individual ships is required. Recently, the IMO launched the Data Collection System on the fuel consumption of ships. Accordingly, from 2019, ships of GT=5,000 and above are required to collect consumption data for each type of fuel they use. The first report is expected by the end of 2019 [48]. It is reasonable to assume that carbon allowances will also be introduced in the shipping sector in the near future, and therefore it is necessary to consider different carbon credit scenarios in the development of future power system options and ship exploitation strategies, as performed by Trivyza et al. [49] for cruise ship energy systems. They developed a bi-objective optimization method (with life-cycle costs (LCC) and lifetime carbon emissions as objectives) for the synthesis of a cruise ship energy system and applied it to identify optimal power system configurations complying with existing emission regulations. Four scenarios of carbon credit are considered in this study which include the non-taxation scenario (NT) and three carbon pricing policy scenarios (CP, NP and SD). The three CP, NP and SD scenarios were obtained by interpolating the forecast values of the CO₂ price from the World Energy Outlook 2018 [50], Figure 13. These values relate to the industrial, aviation and electric power sectors of the European Union for 2025 and 2040, and are presented in Table 2. In this paper, carbon credit refers to emissions expressed in CO₂-eq. For 2019, the price of CO₂ is zero, since carbon credit has still not been implemented in the shipping industry. The considered scenarios are as follows:

- No tax (NT) scenario: carbon credit will not be implemented and there is no cost for CO₂ emissions;
- Current policies (CP) scenario: considering the current policies that have been implemented in the energy sector;

- New policies (NP) scenario: includes existing policies and incorporates the ambitions of policy makers in the energy sector;
- Sustainable development (SD) scenario: involves policy scenarios to comply with the United Nations 2030 agenda for Sustainable Development. In this scenario, the CO₂ price rises to €125/ton.

Table 2 Forecast of CO₂ prices for the European Union [50]

Scenario	Price of 1 ton of CO ₂ (€)	
	2025	2040
Current Policies (CP) scenario	20	34
New policies (NP) scenario	22	38
Sustainable Development (SD) Scenario	56	125

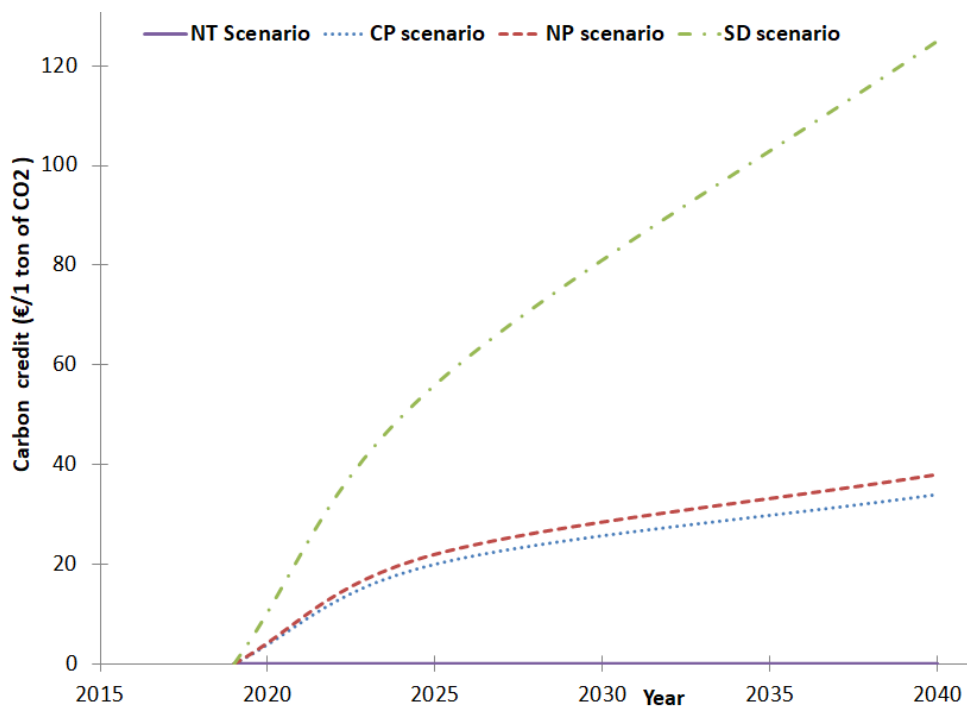

Figure 13 Carbon pricing policies adopted from [50]

Since carbon credit refers to allowances as a permit to emit GHGs during the operation of a ship, these four scenarios are illustrated only using the example of a diesel engine-powered ship.

3.2. Diesel engine-powered ship

The additional investment cost for this ship is not taken into account, since the ship is already built and the scope of this paper is limited to retrofitting options for the existing ship. The cost of diesel for shipping purposes is reduced by the excise duty amount. Accordingly, the price of one litre of diesel is €0.66/L [51]. Taking into account the density of diesel fuel, the ship fuel consumption, the distance of the round trip and the number of round trips per year, the annual costs of fuel are €498,300.

According to Banawan et al. [52], the total annual maintenance cost of a 24 MW diesel engine power plant is \$1,195,600. Since the analysed ship has a total installed power of 2,448 kW, the estimated annual maintenance cost of this ship is \$122,000, i.e. €108,600.

The cost of carbon credit is added to the total costs. According to the scenarios on carbon pricing mentioned in section 3.1 and data on the annual CF of this ship (2.06 kilo tons of CO₂-eq), the carbon credit costs are presented in Table 3 and in Figure 14.

Table 3 Cost of carbon credit during the lifetime of the ship according to four scenarios

NT	CP	NP	SD
€0	€884,800	€957,900	€2,749,300

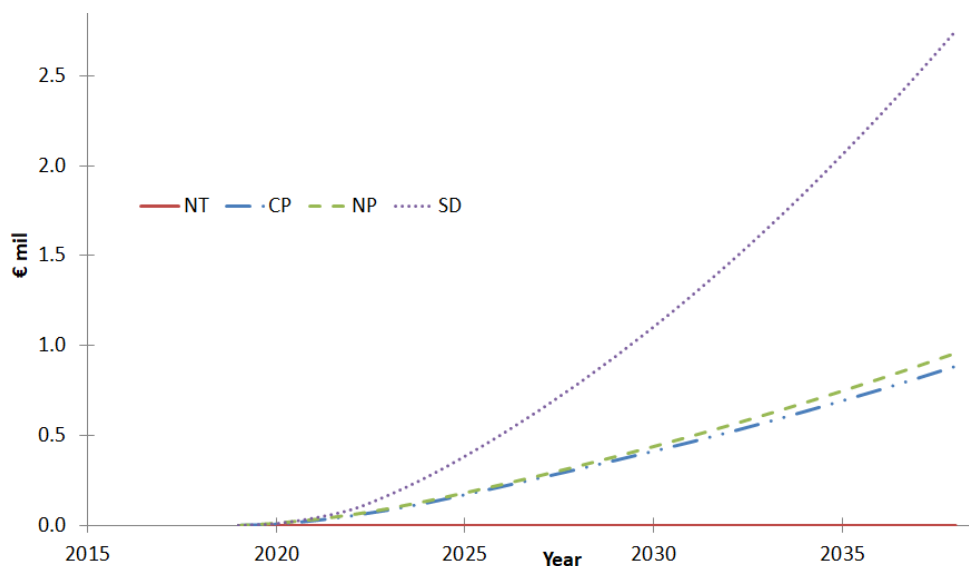

Figure 14 The cost of carbon credit through the entire life span of the ship

3.3. Battery-powered ship

The total price for electricity in the Croatian industrial sector amounts to €78/MWh [51]. Based on the data on ship energy consumption and on the price of electricity, the annual cost of electricity is calculated at €241,200.

One of the obstacles that postpone the large-scale deployment of batteries, and especially of Li-ion batteries, is their high investment cost. The observed costs of battery packs for electrical vehicles based on BNEF (Bloomberg NEF) have decreased from about €870/kWh in 2010 to € 70-215/kWh in 2017. The lower end of the cost range of 2017 coincides with the announcements of market leaders, like Tesla, at about €170/kWh [53]. In this assessment, the battery price used is €200/kWh. Since the required battery capacity is 3,600 kWh, the price of a Li-ion battery is €720,000. As for future Li-ion battery cost scenarios, they are presented in Figure 15, such as in [53].

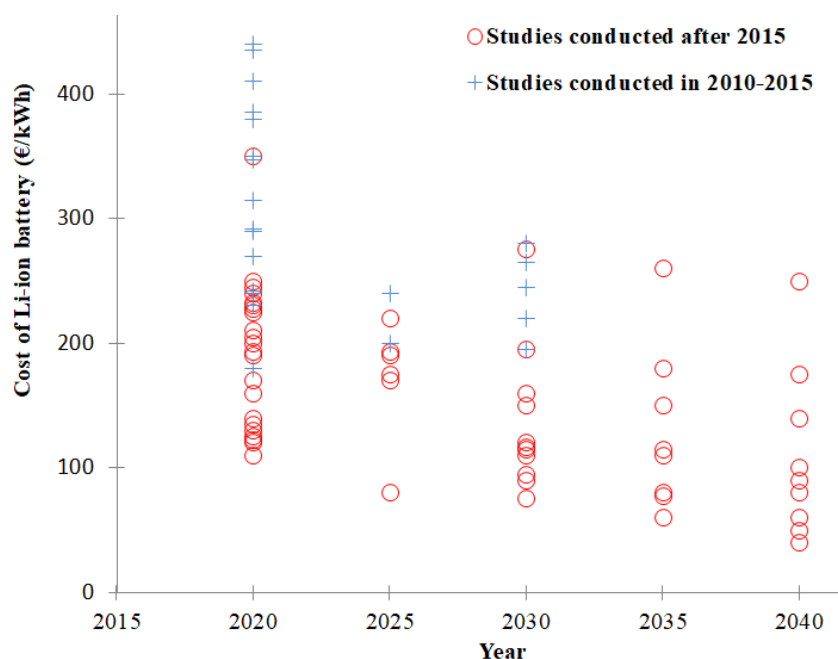

Figure 15 Cost forecasts of a Li-ion battery for electric vehicles

The range of estimates is wide, with values reported from above €400/kWh in the short term to as low as €40/kWh in the long term, and depends on when the study was conducted, as can be seen from Figure 15. The average price estimates, which are used in this paper, are presented in Table 4.

Table 4 Average Li-ion battery price estimates

Year	Cost of Li-ion battery (€/kWh)
2020	244
2025	184
2030	169
2035	129
2040	109

Christos [54] estimated the investment cost to retrofit a double-ended ro-ro passenger ferry into a battery-powered one is €2.2 mil. Roughly 45% of this cost is associated with the battery cost, while the rest refers to electric motors, converters and regulators. In this assessment, the 3,600 kWh battery investment cost is estimated at €878,400. The total additional investment cost would then be around €1,952,000.

The battery is maintenance free, but has a shorter lifetime than the ship. The lifetime of a Li-ion battery is assumed to be 10 years, since many manufacturers provide a warranty for 8 years [53]. Hence, the battery will need to be replaced once in the ship lifetime. The replacement cost is calculated based on the average cost of a Li-ion battery in 2030 which amounts to €169/kWh (Table 4), i.e. the cost of battery replacement would be €608,400.

3.4. PV cells battery-powered ship

The investment and maintenance costs of a Li-ion battery are the same as in the previous subsection, but the electric power consumption is lower. According to section 2.5, 92.37% of the electric power needs are obtained from the Li-ion battery and 7.63% from the PV cells. Therefore, the annual cost of electricity for this option is €222,600.

PV cell costs are continuing to decline, making them more applicable and attractive in areas with excellent solar resources. According to the World Energy Outlook 2018 [50] for the European Union, the investment cost of a PV system in 2017 amounted to \$1,300/kW. By considering new policies, this study presents a scenario with PV costs of \$760/kW for 2040. The annual maintenance cost is assumed to be 20% of capital costs, i.e. \$260/kW. Therefore, the investment costs are calculated at €94,500 and annual maintenance costs amount to €18,900. The maintenance costs of PV cells on board are quite high due to exposure to a salty atmosphere which can trigger corrosion if the PV cells are not protected properly.

4. Discussion

4.1. LCA comparison

In order to evaluate the environmental impact of three different ship power systems as options for retrofitting Croatian ro-ro passenger ships, LCAs were performed. Emissions released during the life cycle of ship power system configurations are presented in Figure 16.

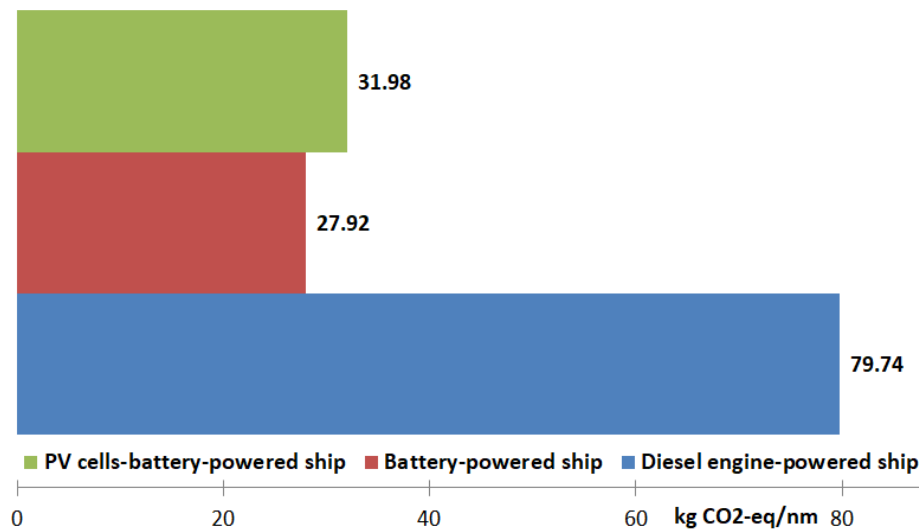

Figure 16 WTW GHG emissions of ships with different power systems

The LCA results show that during its operation, a diesel engine-powered ship emits 72.64 kg CO₂-eq/nm, while emissions from the life cycle of diesel fuel, without its use in a ship, amounts to 7.10 kg CO₂-eq/nm. Considering that a battery-powered ship during its whole life cycle emits 27.92 kg CO₂-eq/nm, it can be confirmed that electrification would significantly reduce the CF of this ship. The third option with PV cells emits a slightly higher amount of GHGs than a battery-powered ship (31.98 kg CO₂-eq/nm). A complete insight into the feasibility of the above solutions is achieved by comparing them also from the economic viewpoint, which is presented in the following section.

4.2. LCCA comparison

The LCCAs of different power system configurations that can be implemented on board are performed. The costs are summarized in Table 5 and in Figure 17. As for the carbon credit cost, two scenarios are taken into account: the NT scenario that matches today's situation in shipping, and the SD scenario which is very rigorous although its inclusion in shipping

regulations would lead to a significant reduction in the CF from the maritime industry. The NT scenario is a non-tax scenario, and therefore the carbon credit cost is €0, while the LCC of the SD scenario is €2,749,300.

Table 5 Costs of different power options during the ship’s lifetime, expressed in euros (€)

Power system options	Additional investment cost	Power source cost	Maintenance cost	Total costs (NT)	Total costs (SD)
Diesel engine	0	9,966,000	2,172,000	12,138,000	14,887,300
Battery	1,952,000	4,824,000	608,400	7,384,400	7,384,400
PV cells-battery	2,046,500	4,452,000	986,400	7,484,900	7,484,900

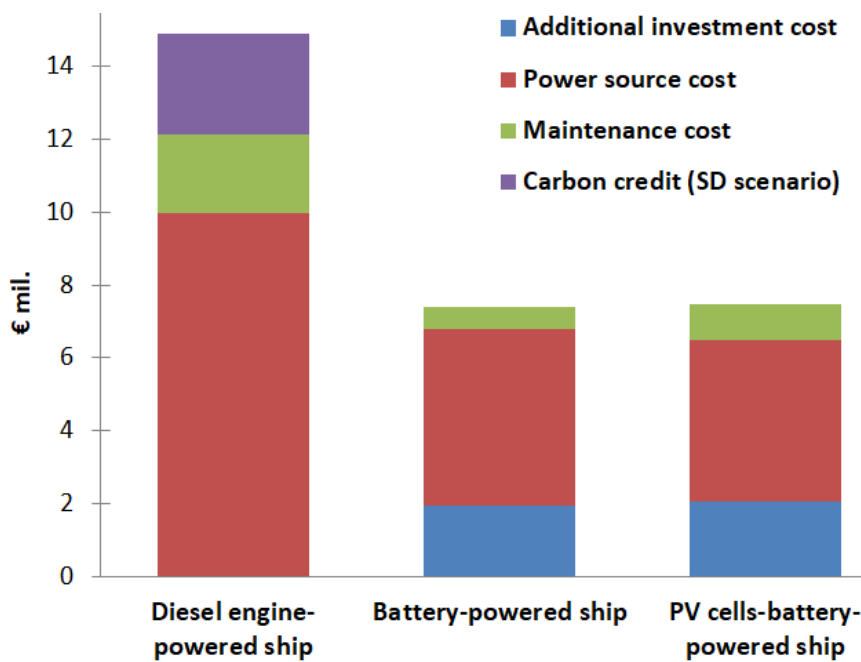

Figure 17 LCCA comparisons of different power system configurations

The diesel engine-powered ship has the highest LCCs (€12,138,000). When the carbon credit cost is added to this amount, the LCCs rise to €14,887,300. Considering that this ship has almost twice the LCCs compared to the other two configurations, and a comparison of the LCAs yields the result that the CF is also by far the highest among the considered configurations, the retrofitting of the existing ship is of great significance. The payback time of the investment cost for a battery-powered ship is 4 years, while for that of a PV cells battery-powered ship it is 5 years.

The results show that electrification of the Croatian short-sea shipping sector seems to be a promising option to reduce its carbon footprint and at the same time to offer significant savings to the ship-owner during the ship exploitation period. Since the majority of ferries in

the Adriatic Sea operate on relatively short routes similar to the one observed, the main findings of this study could be applied to them as well. It is expected that for longer routes the battery capacity should be increased, which would lead to a significant increase in the battery system price and possibly render the battery option unfeasible.

Considering installation of the PV system on other ships, the main difference lies in solar irradiation. In this sense, every route should be viewed separately. Since these differences are rather minor for the Adriatic Sea, it can be stated that application of the PV system in the Croatian ro-ro passenger fleet reduces the environmental impact, but does not increase the cost-effectiveness significantly.

There are some limitations of this study with respect to the input data. Namely, relevant calculations are performed for prices in the Croatian energy sector for 2017, and it is not fully clear whether or not the relation between fuel oil prices and electricity production prices will remain the same for the total ship calculation period. This will, of course, affect the payback time for investment in alternative power system configurations. Higher accuracy would be achieved if the direct measurement results of ship power needs were available. Another limitation of this study is that it does not consider the effect of the electrification of the complete Croatian short-sea shipping fleet on the national electric grid loading.

5. Conclusion

In order to evaluate the environmental impact of different power system configurations for the retrofit of a Croatian ro-ro passenger ship, a comparative cost and life cycle analysis of relevant power system configurations was performed. Apart from the diesel engine which is used in the existing vessel, the applicability of a Li-ion battery and PV cells was considered. The main findings of the performed research are summarized as follows:

- emissions during the life cycle of a diesel engine-powered ship are much higher at 79.74 kg CO₂-eq/nm than from a battery-powered ship yielding 27.92 kg CO₂-eq/nm and from a battery-powered ship with PV cells installed on board at 31.98 kg CO₂-eq/nm;
- during the lifetime of a ship, a diesel engine-powered ship has the highest total costs of €12,138,000 in contrast to a battery-powered ship with costs of €7,384,400 and a PV-cell-battery-powered ship with costs of €7,484,900;
- if carbon credit as a potential carbon reduction policy is included in the assessment, the total cost for the diesel engine-powered ship would increase to €14,887,300.

It can be concluded that from the environmental and economical point of view, the best option for retrofitting the existing ro-ro passenger ship is the implementation of a Li-ion battery on board. The payback time of the investment is 4 years. This is a very important finding which can serve as a guideline both for shipyards and ship-owners in the design and acquisition of new ships, respectively. With a reduction of the investment costs for batteries and PV cells, and an increase in the carbon credit cost, these options are expected to be even more appealing to ship-owners in future.

Based on the findings of this study, and taking into account its limitations, as well as the decarbonization trends in the marine sector, it is reasonable to expect that the Croatian shipping sector should move to power systems based on renewables, where, in some intermediate period, hybrid power system options would be preferable. In this sense, a special task should be the proper sizing of each power source in HPS which is influenced by the total power needs of the ship. In addition, consideration should be given to the availability of a particular source and its effect on the safety of the power system.

Acknowledgement

This research was supported by the Croatian Science Foundation under the project Green Modular Passenger Vessel for Mediterranean (GRiMM), (Project No. UIP-2017-05-1253). Maja Perčić, a Ph.D. student, is supported through the “Young researchers' career development project – training of doctoral students” of the Croatian Science Foundation, funded by the European Union from the European Social Fund. Funding within the international collaborative project Global Core Research Center for Ships and Offshore Plants (GCRC-SOP, No. 2011-0030669), established by the Government of the Republic of Korea (MSIP) through the National Research Foundation of South Korea (NRF), is gratefully acknowledged.

In this paper, LCAs were performed by GREET 18 software produced by UChicago Argonne, LLC under Contract No. DE-AC02-06CH11357 with the Department of Energy.

List of references

- [1] United Nations Framework Convention Climate Change (UNFCCC). Climate Change Information Kit, <https://unfccc.int/resource/iuckit/cckit2001en.pdf>; 2001 [accessed 15 May 2019].

- [2] Environmental Protection Agency. The Kyoto Protocol, <http://www.epa.ie/climate/thekyotoprotocol/>; [accessed 15 May 2019].
- [3] United Nations Framework Convention Climate Change (UNFCCC). Paris Agreement, <https://unfccc.int/process-and-meetings/the-paris-agreement/what-is-the-paris-agreement>; [accessed 15 May 2019].
- [4] Wiedmann T, Minx J. A Definition of “Carbon Footprint”, in: Pertsova C.C., Ecological Economics Research Trends: Chapter 1. Nova Science Publishers, Hauppauge NY; 2008, p. 1-11.
- [5] Fenner AE, Kibert CJ, Woo J, Morque S, Razkenari M, Hakim H, Lu X. The carbon footprint of buildings: A review of methodologies and applications. *Renewable and Sustainable Energy Reviews* 2018; 94, p. 1142-1152.
- [6] Radonjić G, Tompa S. Carbon footprint calculation in telecommunications companies – The importance and relevance of scope 3 greenhouse gases emissions. *Renewable and Sustainable Energy Reviews* 2018; 98, p. 361-375.
- [7] Peter C, Helmnig K, Nendel C. Do greenhouse gas emission calculations from energy crop cultivation reflect actual agricultural management practices? – A review of carbon footprint calculators. *Renewable and Sustainable Energy Reviews* 2017; 67, p. 461-476.
- [8] Ling-Chin J, Heindrich O, Roskilly AP. Life cycle assessment (LCA) – from analysing methodology development to introducing an LCA framework for marine photovoltaic (PV) systems. *Renewable and Sustainable Energy Reviews* 2016, 59, p. 352-378.
- [9] Vladimir N., Ančić I., Šestan A. Effect of ship size on EEDI requirements for large container ships. *Journal of Marine Science and Technology* 2018; 23, p. 42–51.
- [10] Third IMO GHG Study, <http://www.imo.org/en/OurWork/Environment/PollutionPrevention/AirPollution/Documents/Third%20Greenhouse%20Gas%20Study/GHG3%20Executive%20Summary%20and%20Report.pdf>; 2014 [accessed 15 May 2019].
- [11] MEPC. Amendments to the Annex of the protocol of 1997 to amend the international convention for the prevention of pollution from ships, as modified by the protocol of 1978 relating there to. Resolution MEPC 203 (62), 2011, London, UK.
- [12] MEPC. Regulations for the prevention of air pollution from ships. Resolution MEPC 176 (58), 2008, London, UK.
- [13] <https://www.dieselnet.com/standards/inter/imo.php> [accessed 28 November 2019].
- [14] Ančić I, Theotokatos G, Vladimir N. Towards improving energy efficiency regulations of bulk carriers. *Ocean Engineering* 2018; 148, p. 193-201.

- [15] Ančić I, Šestan A. Influence of the required EEDI reduction factor on the CO₂ emission from bulk carriers. *Energy Policy* 2015; 84, p. 107-116.
- [16] Traut M, Larkin A, Anderson K, McGlade C, Sharmina M, Smith T. CO₂ abatement goals for international shipping. *Climate Policy* 2018; 18, p. 1066-1075.
- [17] MEPC. Guidance on Treatment of Innovative Energy Efficient Technologies for Calculation and Verification of the Attained EEDI, MEPC.1/Circ.815, London, UK, 2013.
- [18] MEPC. Guidelines on the Method of Calculation of the Attained Energy Efficiency Design Index (EEDI) for New Ships, MEPC Resolution 245(66), London, UK, 2014.
- [19] Ančić I, Vladimir N, Runko Luttenberger L. Energy efficiency of ro-ro passenger ships with integrated power system. *Ocean Engineering* 2018; 16, p. 350-357.
- [20] Ančić I, Vladimir N, Cho DS: Determining environmental pollution from ships using Index of Energy Efficiency and Environmental Eligibility (I4E). *Marine Policy* 2018; 95, p. 1-7.
- [21] Ozaki Y, Larkin J, Tikka K, Michel K. An evaluation of the Energy Efficiency Design Index (EEDI) baseline for tankers, containerships and LNG carriers. *Climate Change and Ships: Increasing Energy Efficiency a SNAME & Marine Board Symposium, USA, 2010.*
- [22] Johnson H, Johansson M, Andersson K. Will the ship energy efficiency management plan reduce CO₂ emissions? A comparison with ISO50001 and the ISMcode. *Maritime Policy Management: Flagship J. Int. Shipp. Port Res.* 2013; 40(2), 177–190.
- [23] Armstrong VN, Banks C. Integrated approach to vessel energy efficiency. *Ocean Engineering* 2015; 110, p. 39-48.
- [24] Klebanoff LE, Pratt JW, Leffers CM, Sonerholm KT, Escher T, Burgard J, Ghosh S. Comparison of the greenhouse gas and criteria pollutant emissions from the SF-BREEZE high-speed fuel-cell ferry with diesel ferry. *Transportation Research Part D* 2017; 54, p. 250-268
- [25] Yu W, Zhou P, Wang H. Evaluation on the energy efficiency and emissions reduction of a short-route sightseeing ship. *Ocean Engineering* 2018; 162, p. 34-42.
- [26] Díaz-de-Baldasano MC, Mateos FJ, Núñez-Rivas LR, Leo TJ. Conceptual design of offshore platform supply vessel based on hybrid diesel generator-fuel cell power plant. *Applied Energy* 2014; 116, p. 91-100.

- [27] Ahn J, Ho Park S, Noh Y, Il Choi B, Ryu J, Chang D, Brendstrup KLM. Performance and availability of a marine generator-solid oxide fuel cell-gas turbine hybrid system in a very large ethane carrier. *Journal of Power Sources* 2018; 399, p. 199-206.
- [28] Gagatsi E, Estrup T, Halatsis A. Exploring the potentials of electrical waterborne transport in Europe: the E-ferry concept. *Transportation Research Procedia* 2016; 14, p. 1571-1580.
- [29] International standard ISO 14040 – Life cycle assessment, <https://web.stanford.edu/class/cee214/Readings/ISOLCA.pdf>; 1997 [accessed 20 May 2019].
- [30] Ship particulars, Uljanik, <https://www.uljanik.hr/hr/uljanik-grupa/uljanik-d-d/nasi-proizvodi?id=354#paragraph17>; [accessed 20 May 2019].
- [31] Schedule of ferry route Ploče-Trpanj, <https://www.jadrolinija.hr/docs/default-source/lokalne-linije-2019/633-plo%C4%8De---trpanj-2019.pdf?sfvrsn=2>; [accessed 22 May 2019].
- [32] Ro-Ro passenger ship, <https://www.jadrolinija.hr/o-nama/brodovi/trajekti/trajekti-lokalnih-linija/kornati>; [accessed 15 July 2019].
- [33] Environmental Protection Agency. Emission factors, https://www.epa.gov/sites/production/files/2018-03/documents/emission-factors_mar_2018_0.pdf; 2018 [accessed 15 May 2019].
- [34] Environmental Protection Agency. Understanding the Global Warming Potentials, <https://www.epa.gov/ghgemissions/understanding-global-warming-potentials>; [accessed 15 May 2019].
- [35] Croatian Energy Regulatory Agency, Annual Report, https://www.hera.hr/en/docs/HERA_Annual_Report_2016.pdf; 2016 [accessed 21 May 2019].
- [36] Zubi G, Dufo-López R, Carvalho M, Pasaoglu G. The lithium-ion battery: State of the art and future perspectives. *Renewable and Sustainable Energy Reviews* 2018; 89, p 292-308.
- [37] Structure of Croatian electric energy, <http://www.hep.hr/elektra/trziste-elektricne-energije/izvori-elektricne-energije/1553#>; [accessed 20 May 2019].
- [38] Energy Market Authority and Building and Construction Authority, Handbook for solar photovoltaic (PV) systems, ISBN: 978-981-08-4462-2, http://www.bca.gov.sg/publications/others/handbook_for_solar_pv_systems.pdf; 2011 [accessed 29 May 2019].

- [39] Liu H, Zhang Q, Qi X, Han Y, Lu F. Estimation of PV output power in moving and rocking hybrid energy marine ships. *Applied Energy* 2017, 204, p. 362-372.
- [40] Zaninović K, Gajić-Čapka M, Perčec Tadić M. *Climate atlas of Croatia 1961-1990., 1971-2000.* Croatian Meteorological and Hydrological Service 2008, Zagreb, Croatia.
- [41] Kobougias I, Tatakis E, Prousalidis J. PV Systems Installed in Marine Vessels: Technologies and Specifications. *Advances in Power Electronics* 2013. <http://dx.doi.org/10.1155/2013/831560>.
- [42] End-Of-Life Management: Solar Photovoltaic Panels, International Renewable Energy Agency (IRENA), https://www.irena.org/documentdownloads/publications/irena_ieapvps_end-of-life_solar_pv_panels_2016.pdf, [accessed 31 May 2019].
- [43] Crystalline PV Panel, http://www.ilsight.com/images/Alpsx_SolarPanels_240_255.pdf, [accessed 31 May 2019].
- [44] Stiglitz JE, Stern N, Duan M, Edenhofer O, Giraud G, Heal G, Lèbre la Rovere E, Morris A, Moyer E, Pangestu M, Shukla PR, Sokona Y, Winkler H, 2017. Report of the High-Level Commission on Carbon Prices. World Bank, Washington, DC.
- [45] Tvinnereim E, Mehling M, 2018. Carbon pricing and deep decarbonisation. *Energy Policy* 2018; 121, p.185-189.
- [46] Brewer TL. Black carbon emissions and regulatory policies in transportation. *Energy Policy* 2019; 129, p. 1047-1055.
- [47] EU Emissions Trading System, https://ec.europa.eu/clima/policies/ets_en; [accessed 26 May 2019].
- [48] Data Collection System on fuel consumption, IMO, <http://www.imo.org/en/OurWork/Environment/PollutionPrevention/AirPollution/Pages/Data-Collection-System.aspx>; 2018, [accessed 27 May 2019].
- [49] Trivyza NL, Rentizelas A, Theotokatos G. Impact of carbon pricing on the cruise ship energy systems optimal configuration. *Energy* 2019; 175, p. 952-966.
- [50] International Energy Agency. *World Energy Outlook 2018*, <https://doi.org/10.1787/20725302>.
- [51] Energy prices and costs in Europe, Annex 3; https://ec.europa.eu/energy/sites/ener/files/documents/annex_3_-_country_sheets_-_part_4_of_4_post_isc-v2.pdf; 2018 [accessed 21 May 2019].
- [52] Banawan AA, El Gohary MM, Sadek IS. Environmental and economical benefits of changing from marine diesel oil to natural-gas fuel for short-voyage high-power

passenger ships. *Journal of Engineering for the Maritime Environment* 2010, 224(2), p. 103-113.

- [53] Tsiropoulos I, Tarvydas D, Lebedeva N. Li-ion batteries for mobility and stationary storage applications, JCR Science for Policy Report, European Commission, <http://publications.jrc.ec.europa.eu/repository/bitstream/JRC113360/kjna29440enn.pdf>; 2018 [accessed 22 May 2019].
- [54] Christos B. Techno-economical feasibility study on the retrofit of double-ended Ro/Pax ferries into battery-powered ones. Diploma thesis. National Technical University of Athens, School of Naval Architecture and Marine Engineering, 2017.

ARTICLE 3

Preprint of the published journal article.

Life-Cycle Cost Assessment of Alternative Marine Fuels to Reduce the Carbon Footprint in Short-Sea Shipping: A Case Study of Croatia

Maja Perčić¹, Nikola Vladimir^{*1}, Ailong Fan²

¹*University of Zagreb, Faculty of Mechanical Engineering and Naval Architecture, Ivana Lučića 5, 10002 Zagreb, Croatia*

²*School of Energy and Power Engineering, Wuhan University of Technology, Wuhan, China*

Abstract

The reduction of emissions generated by internal combustion engines represents one of the most important research topics in the marine sector. This especially refers to carbon dioxide (CO₂) which is a major greenhouse gas. This paper deals with the viability of alternative fuels to reduce CO₂ emissions in the Croatian short-sea shipping sector over a ship lifetime. The aim of the study is to identify appropriate alternatives to diesel-powered options, taking account of environmental and economic criteria. Besides diesel, which is currently the main marine fuel in Croatia, an analysis was conducted of electricity, methanol, dimethyl ether, natural gas, hydrogen and biodiesel, and the results are illustrated on three different Croatian ro-ro passenger ships, operating on short, moderate and relatively long routes, respectively. Life-Cycle Assessment (LCA) indicated the most environmentally friendly power system configuration with alternative fuel. The investigation from an economical point of view was performed by Life-Cycle Cost Assessment (LCCA) which also considered potential carbon allowance scenarios. The results highlighted an electricity-powered ship as the most ecological as well as the most cost-effective option among those that are investigated, taking account of the real Croatian electricity mix that includes 46% of renewable sources.

Keywords: alternative fuel; carbon footprint; carbon allowance; LCA, LCCA; short-sea shipping

* Corresponding author, e-mail: nikola.vladimir@fsb.hr, phone: +385 1 61 68 114

Nomenclature

Variables

<i>B</i>	breadth (m)
<i>BC</i>	battery capacity (kWh)
<i>CA</i>	carbon allowance (€/t CO ₂)
<i>E</i>	electricity consumption (kWh/nm)
<i>EC</i>	energy consumption (kWh/nm)
<i>EF</i>	emission factor (g emission/kg)
<i>FC</i>	fuel consumption (kg/nm)
<i>IC</i>	investment cost (€)
<i>l</i>	length of one-way trip (nm)
<i>LCCEC</i>	life-cycle carbon emission cost (€)
<i>LCFC</i>	life-cycle fuel cost (€)
<i>LCMC</i>	life-cycle maintenance cost (€)
<i>LM</i>	lifetime mileage (nm)
<i>LT</i>	lifetime (year)
<i>m</i>	weight of an engine (t)
<i>N</i>	number of round trips (-)
<i>NCV</i>	net calorific value (kWh/kg)
<i>P</i>	power (kW)
<i>PR</i>	price (€)
<i>SFC</i>	specific fuel consumption (kg/kWh)
<i>T</i>	draught (m)
<i>TE</i>	tailpipe emission (kg emission/nm)
<i>v</i>	speed (kn)
<i>x</i>	share of a fuel (%)

Subscripts

<i>A</i>	annual
<i>AE</i>	auxiliary engine
<i>ave</i>	average
<i>BD</i>	biodiesel
<i>CNG</i>	CNG-powered ship
<i>D</i>	diesel-powered ship
<i>de</i>	design
<i>DME</i>	DME-powered ship
<i>E</i>	electricity-powered ship
<i>EL</i>	electrolyser
<i>FC</i>	fuel cell
<i>H</i>	hydrogen-powered ship
<i>i</i>	emission
<i>LNG</i>	LNG-powered ship
<i>M</i>	methanol-powered ship
<i>ME</i>	main engine
<i>NG</i>	natural gas-powered ship
<i>P-DME</i>	pilot fuel in DME-powered ship
<i>P-M</i>	pilot fuel in methanol-powered ship
<i>P-NG</i>	pilot fuel in natural gas-powered ship

Abbreviations

CF	Carbon Footprint
CNG	Compressed Natural Gas
CP	Current Policies
DME	Dimethyl Ether
ECA	Emission Control Area
GHG	Greenhouse Gas
GWP	Global Warming Potential
HFO	Heavy Fuel Oil
IMO	International Maritime Organization
LCA	Life-Cycle Assessment
LCCA	Life-Cycle Cost Assessment
LNG	Liquefied Natural Gas
LPG	Liquefied Propane Gas
NT	Non-taxation
PEM	Proton Exchange Membrane
PTW	Pump-to-Wheel
PV	photovoltaic
RES	Renewable Energy Source
SD	Sustainable Development
SP	Stated Policies
WTP	Well-to-Pump
WTW	Well-to-Wheel

Greek symbols

η	efficiency (-)
--------	----------------

Units

kn	knot (nm/h)
nm	nautical mile (1 nm = 1.852 km)

1. Introduction

Global warming and related climate changes are one of the major problems that the global community is facing today. They have a negative effect on the environment and human health and are the result of anthropogenically increased levels of Greenhouse Gas (GHG) emissions in the atmosphere, i.e. emissions of carbon dioxide (CO₂), methane (CH₄), nitrous oxide (N₂O) and, in low concentrations, fluorinated gases [1]. In order to evaluate the pollution contribution of different GHGs, the Global Warming Potential (GWP) has been developed and refers to a measure of how much energy the emission of one ton of a gas will absorb over a given period, relative to the emission of one ton of CO₂, and is expressed in CO₂ equivalent (CO₂-eq) [2]. Since a major source of GHGs is fossil fuel combustion, energy and transport sectors exert a big influence in this regard [3].

Exhaust gases released from the combustion of fossil fuel in marine engines consist of different components, such as carbon dioxide (CO₂), carbon monoxide (CO), nitrogen oxides (NO_x), sulphur oxides (SO_x), hydrocarbons (HC) and particulate matter (PM), and their negative effects on the environment and on people are more pronounced when ships spend greater time near populated areas [4]. According to the Third GHG Study of the International Maritime Organization (IMO), international shipping in 2012 generated 2.1% of global GHGs and this amount is expected to grow from 50% to 250% by the end of 2050 [5]. With the UN holding that each sector should proportionately be involved in the reduction of GHGs, the shipping sector is being pushed to reduce its Carbon Footprint (CF). This term represents a relative measure of the total amount of CO₂ or CO₂-eq emissions caused by indirect or direct activity, or is accumulated over the life cycle of a product [6].

According to the recent emission goals, international shipping needs to reduce its CF by 40% by 2030, and by at least 70% by 2050 compared to 2008 [7]. CF reduction can be achieved by certain technical and operational measures [8]. Among technical measures, replacement of conventional fossil fuels with alternative cleaner fuels with lower carbon content seems to be the most effective method to achieve the decarbonization of the shipping sector. In most cases, alternative fuels also have low nitrogen and sulphur content, which is important for ships that operate in Emission Control Areas (ECAs) where the emission requirements are stricter than global ones [9]. Nowadays, the most dominant conventional propulsion system used in the shipping sector is the diesel engine fuelled by Heavy Fuel Oil (HFO) which has high carbon content whose combustion results in a great amount of GHGs

[10]. Widely analysed alternative fuels that can be used to replace conventional fuels (e.g. HFO, diesel) include natural gas, hydrogen, biofuels, electricity, methanol, etc.

Natural gas, in the form of Liquefied Natural Gas (LNG), is the most frequently used alternative fuel in shipping. Due to its lower sulphur, carbon and nitrogen content, its application is significant in ECAs. Livanos et al. [11] investigated alternative propulsion for a ferry operating in an ECA and compared a diesel engine and a dual-fuel engine (LNG and Marine Diesel Oil as a pilot fuel) with and without a waste heat recovery system. Even though the application of LNG leads to lower operating costs, a reduction of emissions and an increase in power system efficiency, the authors indicated major challenges related to investment costs, the lack of LNG infrastructure in ports, and safety measures. Schinas and Butler in [12] also indicated these problems and concluded that ships which operate on fixed routes have a higher potential for LNG propulsion. Another issue relating to the use of LNG is “methane slip” which occurs when methane from the fuel remains unburned and is released together with the exhaust gas. However, for modern 2-stroke engines this problem practically disappears [13]. Jafarzadeh et al. [14] investigated LNG as a fuel for use in fishing vessels and concluded that LNG is a viable option for improving their environmental footprint.

Another fossil fuel whose application has been widely investigated is methanol. The first methanol-powered ferry was Stena Germanica, launched in 2015 and powered by methanol and marine gas oil [15]. In order to investigate its viability, IMO conducted a study where the environmental impact of the methanol was assessed by Life-Cycle Assessment (LCA). The results showed that the life-cycle GHGs of methanol are higher than those of conventional fuels. Although the implementation of methanol is achievable, its cost-effectiveness greatly depends on the area of navigation, the price of the methanol, and the investment cost [16].

A further viable solution to reduce the environmental footprint of the shipping sector is to use renewable methanol (i.e. biomethanol) [17] whose production is feasible and can reduce the CF, especially when wind-energy-based hydrogen and CO₂ are used, as analysed in a study by Matzen et al. [18]. Biofuels are produced from renewable sources such as plant biomass, vegetable oil or waste, and in recent years they have attracted great attention. They are considered to be “carbon-neutral” given the general opinion that CO₂ emissions released from the combustion of biofuel in the atmosphere are absorbed by new biomass which will be further used for biofuel production [19]. These CO₂ emissions are not included in total life-cycle

emissions, while CH₄ and N₂O emissions are considered negligible [16]. Matzen and Demirel investigated methanol and dimethyl ether (DME) as alternative fuels obtained from renewable hydrogen and carbon dioxide. Their analysis showed that these alternative fuels achieved an 82-86% reduction of GHGs compared to conventional fossil fuels [20]. Wang and Demirel analysed the possibility of using exhaust gasses in coal-fired power plants to produce methanol. This fuel can later be used as marine fuel if its viability for a specific location can be proven by a relevant techno-economic assessment [21].

Hydrogen as a marine fuel may offer zero-emission shipping. Even though it can be used in gas turbines and internal combustion engines (with low efficiency), due to its electrochemical kinetics, hydrogen is suitable for use in a fuel cell, an innovative technology based on the direct conversion of the chemical energy of fuel into electric energy via electrochemical reactions. Hydrogen storage is one of the main obstacles for its wider application in the marine sector which has led to on board hydrogen production from hydrogen carriers (i.e. natural gas, methanol, ethanol, etc.) [22]. According to DNV GL-Maritime [23], the investment costs of hydrogen use in the marine sector are rather high but are expected to fall with the mass production of fuel cells.

The potential of alternative fuels in the shipping sector has been investigated by many studies. Brynolf et al. [24] analysed the environmental impact of LNG, liquefied biogas, methanol and biomethanol. The performed LCA comparison indicated that biofuels are a better solution for reducing the CF than replacing conventional HFO fuel with fossil LNG and methanol. A similar study was conducted by Gilbert et al. [25], in which the LCA comparison of alternative marine fuels was performed, indicating that biofuels showed a reduction of 57% to 79% of GHGs compared to conventional fuels. However, these studies focused only on environmental impact, i.e. life-cycle emissions, as an indicator of whether alternative fuel is suitable for use in the shipping sector. They did not take into account fuel-related costs or other fuels such as hydrogen and electricity. Deniz and Zincir [26] performed an evaluation of methanol, ethanol, LNG and hydrogen based on eleven comparison criteria which include the costs related to fuels. The fuels are scaled according to the obtained comparison points which are given for each criterion. Their research results indicated that methanol and ethanol had the lowest points (due to safety concerns, bunker capacity, engine performance, the negative effect on combustion chamber components and lower cost effectiveness); hydrogen was confirmed as a potential alternative fuel, but further investigation of its use on board ship is required, while LNG was indicated as the most suitable alternative marine fuel. Even though Deniz and Zincir

gave a better insight into the viability of alternative fuels in the shipping sector, they did not investigate the application of fuel on a real ship and their research conclusions are based on a theoretical investigation. Fernández-Dacosta et al. [27] performed an environmental and economical assessment of transportation fuels which are considered to provide low-carbon transportation, such as hydrogen and methanol/dimethyl ether (which are synthesized by using CO₂ as a feedstock). The analysis revealed that hydrogen produced by electrolysis is the most environmentally friendly solution, while hydrogen produced from steam reforming is the most cost-effective fuel. However, this study does not refer to the shipping sector directly and it does not provide an environmental and economic assessment of fuel used on a ship.

The ultimate game-changer in the decarbonization of the shipping industry is the introduction of a battery-powered ship. Gagatsi et al. [28] investigated a fully electrified ferry which promotes zero-emission shipping with only an on-board battery as the main power source. This kind of ship does not emit exhaust gases during its operation. However, life-cycle emissions should include sources aimed at electricity generation and used to power the battery, i.e. if the sources are mainly renewable, the life-cycle emissions will be lower. The main conclusion of the study relates to the sustainability and cost-effectiveness of electrified ferries in European waterborne transport. In the future, this e-concept is expected to become the most economical solution which involves higher investment costs but lower operating costs. Lindstad et al. [29] reported a reduction of GHGs through the use of batteries and internal combustion engines on an existing ship. Even though the price of the battery is an obstacle to its greater use, lower prices and further development will ensure better performance and lower emissions due to the manufacturing process of batteries.

The applicability of alternative fuels in the maritime sector is highly dependent on the fleet type, ship exploitation, ship technical performance, investment costs, environmental impact, and the geographical location that indirectly determines the availability of alternative fuels. The major part of the Croatian ro-ro passenger fleet includes outdated vessels powered by diesel engines that have low energy efficiency and which should be replaced in the near future following environmental trends. To the best of the authors' knowledge, there is no available literature providing guidelines for shipbuilders and shipowners in the design and acquisition of new energy-efficient and environmentally friendly ship power systems appropriate for the operating conditions of the Adriatic Sea. In addition, all the above references do not consider the potential carbon emission cost in the short-sea shipping sector that might significantly change the environmental and economic framework in the design of ship power

systems. This paper aims to address the mentioned literature gap by considering the viability of alternative fuels to replace classic diesel-powered solutions to reduce CO₂ emissions at a reasonable cost. An analysis of electricity, methanol, DME, natural gas, hydrogen and biodiesel was conducted from an environmental and economical point of view and illustrated in the case of three different Croatian ro-ro passenger ships. The most environmentally friendly fuel was identified with an LCA, while a Life-Cycle Cost Assessment (LCCA) was performed to identify the most economically viable solution. The original contribution of this paper can be summarized as follows: (a) the development of a model to calculate the CF of Croatian ro-ro passenger ships; (b) identification of alternative marine fuels applicable in the Croatian short-sea shipping sector; (c) the determination of the most economical and ecological power system configuration with an alternative fuel implemented on board a ship. With the potential implementation of the carbon pricing policy in the short-sea shipping sector, there would be an even higher incentive to reduce the CF of a ship. Therefore, this paper also considers the effect of different carbon allowance scenarios on the life-cycle costs of ship power systems with alternative fuels.

2. Methodology

2.1. Selected ships and their particulars

In order to cover the full range of possible practical applications in the Croatian short-sea shipping sector, representative ro-ro passenger ships, i.e. ferries, that operate on very short (Ship 1), medium (Ship 2) and relatively long routes (Ship 3) were selected. Ship 1 connects the settlements of Prizna and Žigljen and represents the shortest Croatian ferry line. Ship 2 on the route Ploče-Trpanj connects two parts of the Croatian mainland and is a medium-long route, while Ship 3 connects the city of Split with the island of Vis and is the longest Croatian ferry line, Figure 1.

Ship 1**Ship 2****Ship 3**

Figure 1 Selected ships [30]

The main particulars of the selected diesel-fuelled ships were obtained from the Croatian Register of Shipping [31], Table 1, while data related to the annual shipping schedule were taken from [32]. The baseline power system configuration refers to the existing one with a new diesel engine. Since each of the considered ships is already in service, each for a different amount of time, it is assumed that for the following 20 years the new diesel engine would not have to be replaced. Therefore, these 20 years represent the common lifetime (LT), during which emissions released from the different power systems implemented on these ships are analysed.

Table 1 Main ships particulars

	Ship 1	Ship 2	Ship 3
Route	Prizna-Žigljen	Ploče-Trpanj	Vis-Split
Ship name	Prizna	Kornati	Petar Hektorović
Length between perpendiculars, L_{pp} (m)	52.4	89.1	80
Breadth, B (m)	11.7	17.5	18.0
Draught, T (m)	1.63	2.40	3.80
Main engine(s) power, P_{ME} (kW)	792	1,764	3,600
Auxiliary engine(s) power, P_{AE} (kW)	84	840	1,944
Design speed, v_{de} (kn)	8.0	12.3	15.75
Passenger capacity	300	616	1,080
Vehicle capacity	60	145	120
Trip duration, t (min)	15	60	140
Route length, l (nm)	1.61	8.15	30.2
Annual number of return trips, N_A	1,590	1,740	800
Lifetime, LT (years)	20		

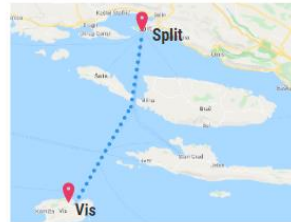
Due to keeping to the operating schedule, reducing fuel consumption, and weather conditions, the ship operating speed often differs from the ship design speed (v_{de}). The average ship speed (v_{ave}) is calculated by dividing the route length (l) by the trip duration (t). Since the ship power is roughly proportional to the cube of its speed, the average main engine(s) power ($P_{ME,ave}$) was calculated according to the following equation:

$$P_{ME,ave} = (P_{ME} \cdot 0.8) \cdot (v_{ave}/v_{de})^3. \quad (1)$$

The average load of the auxiliary engine(s) $P_{AE,ave}$ is estimated to be 50%. By summing up $P_{ME,ave}$ and $P_{AE,ave}$, the total average ship power (P_{ave}) is calculated. The energy consumption per distance of the existing, diesel-powered ship (EC) is then calculated according to:

$$EC = \frac{P_{ave}}{v_{ave}}. \quad (2)$$

The energy needs and EC for each different power system configuration installed on the existing ship are equal to those for the existing diesel-powered ship. The fuel consumption per distance (FC_D) of the ship is calculated by multiplying EC with the specific fuel consumption (SFC_D), such as in the equation:

$$FC_D = EC \cdot SFC_D. \quad (3)$$

For high-speed diesel engines, the SFC_D is assumed to be 0.215 kg/kWh [33].

2.2. LCA

2.2.1. General

Increased awareness of global warming and stringent regulations on environmental protection have forced the global community to investigate the environmental impact of products. This assessment is performed using the LCA. This life-cycle approach considers the environmental impact from raw material extraction, through manufacturing, use, and final disposal of a product, Figure 2, [34].

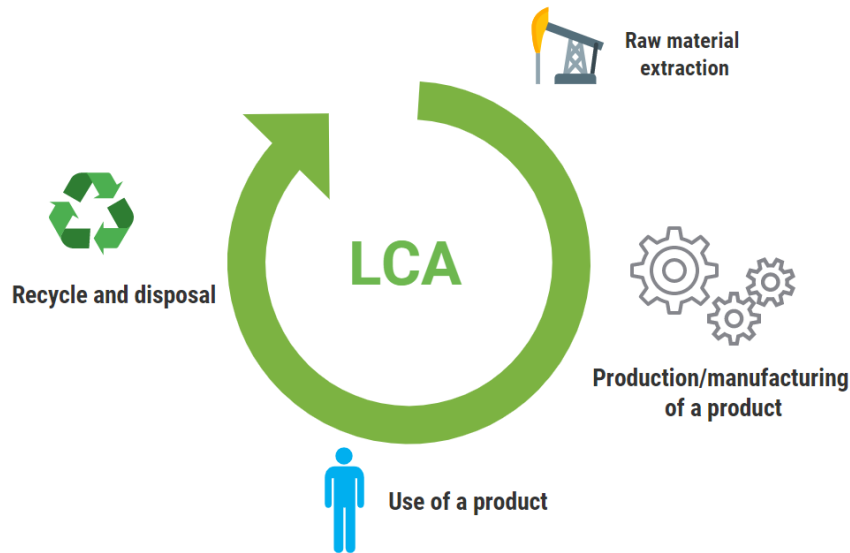

Figure 2 Life-cycle of a product and its life stages

Leading LCA standards ISO 14040 [35] and ISO 14044 [36] provide a framework and requirements which mainly focus on the process of performing the LCA which, among other things, require the definition of the goal and the scope of the assessment, the functional unit, the system boundary and the life-cycle inventory. In this paper, the goal of the LCA is an investigation of the environmental impact of different ship power systems, focusing only on GHG emissions, i.e. the CF, released during the ship lifetime of 20 years. Therefore, the functional unit, which refers to the key element by which different products can be compared, is the CF of the power system configuration released during the ship lifetime, and is presented in tons of CO₂-eq. This assessment should provide insight into the feasibility of different alternative fuels in the shipping sector by comparing the total life-cycle emissions of alternatives with the basic scenario, i.e. a diesel-powered ship, which is currently the most frequently used power system configuration in Croatia.

The comparative LCA is performed by means of the LCA software GREET 2019, which has in its database many processes, fuel, materials, etc. This software offers two main analysis options, depending on the system boundaries. One option refers to the investigation of emissions released from the processes in the Well-to-Pump (WTP) phase, i.e. raw material extraction, the production of fuel and its transportation to a pump. Another option considers emissions released from the processes in the Well-to-Wheel (WTW) phase, i.e. the WTP phase plus the process of product use, known as the Pump-to-Wheel (PTW) phase.

The system boundary of the performed LCAs is presented in Figure 3, where the inputs refer to the energy sources used in each life-cycle stage, while the results of the LCA represent

the emissions associated with these life-cycle stages. For a particular power system configuration, the system boundary is presented in the figure where the processes included in the LCA are presented.

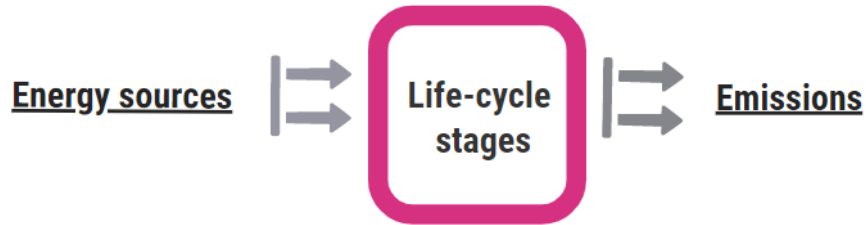

Figure 3 System boundary of the performed LCAs

In the shipping sector, use of a product refers to the ship operation, where PTW emissions, i.e. tailpipe emissions (TE), are released due to the combustion of fuel in the marine engine and are calculated by multiplying the fuel consumption (FC) with the emission factors (EF) according to the following equation:

$$TE_i = FC \cdot EF_i, \quad (4)$$

where the subscript i refers to any emissions (e.g. CO_2 , CH_4 , N_2O , NO_x , SO_x , etc).

In this paper, GHG emissions released during the life cycle of different ship power system configurations with different fuels are expressed in CO_2 -eq with the following equation:

$$CF = GWP_{CO_2} \cdot TE_{CO_2} + GWP_{CH_4} \cdot TE_{CH_4} + GWP_{N_2O} \cdot TE_{N_2O} \quad (5)$$

In order to analyse the CF of an entire configuration, beside WTW emissions, the emissions released due to the manufacturing of the main element(s) of the configuration are considered, e.g. engine, battery, fuel cell, etc. Each element is investigated from the point of view of the total lifetime mileage. With the assumption that each ship has a lifetime of 20 years (LT), the lifetime mileage is calculated according to:

$$LM = LT \cdot N_A \cdot 2 \cdot l, \quad (6)$$

where N_A refers to the annual number of round trips and l refers to the length of a one-way trip.

2.2.2. The LCA of a diesel-powered ship

Before analysing alternative marine fuels, the environmental impact of the currently used power system configuration, i.e. the diesel-powered ship, is determined. It serves as a baseline to evaluate the alternative powering options. The energy needs for the existing ships are presented in section 2.1. The performed LCA of a diesel-powered ship considers emissions released from the diesel engine manufacturing process, the processes of the WTP phase (crude

oil recovery, its transportation to the refinery, diesel refining and its distribution to the pump) and the PTW phase (the combustion of diesel in the engine). All these emissions contribute to the CF of a diesel-powered ship, Figure 4.

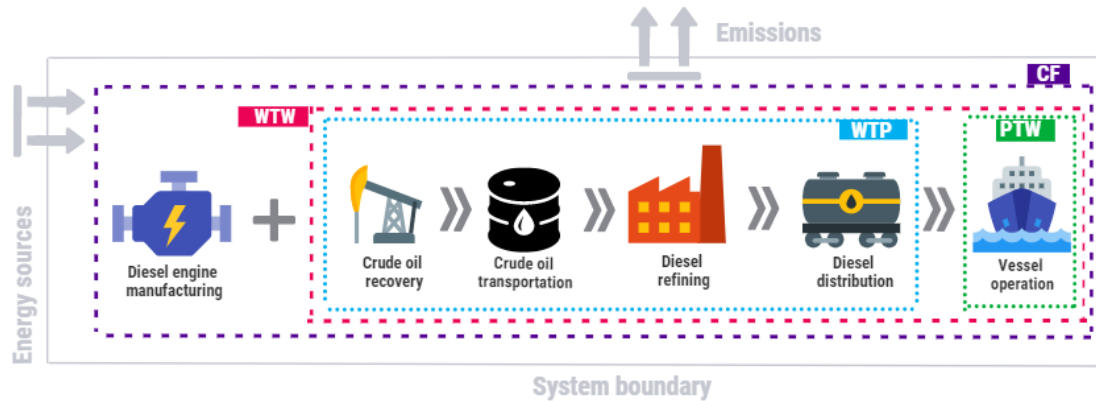

Figure 4 Processes included in the LCA of a diesel-powered ship

The Croatian shipping sector uses “Eurodiesel Blue” as a fuel which is diesel with up to 0.5% sulphur, painted blue according to the Regulation on the Implementation of the Excise Duty Act [37]. According to density, it corresponds to "Conventional Diesel" from the GREET 2019 database, from where the basic parameters of the diesel refining process and the process of conventional crude oil recovery are obtained. Crude oil is primarily imported from the Middle East and is the raw material for diesel production in Croatia. The assumed crude oil transportation process involves transport by tank trucks from the exploitation site to the port (500 km) where the crude oil is loaded on a tanker, which sails to Croatia (4,000 km), to the Omišalj terminal from where it is transported by pipeline to the refinery (7 km). For reasons of simplicity, it is assumed that the diesel is produced only in the Rijeka refinery [38]. After the diesel is produced, tank trucks transport it to a refuelling station. This distance is different for each ship because it depends on where the ship is refuelled. Therefore, this distance for Ship 1 is 100 km (from Rijeka to Prizna), for Ship 2 it is 450 km (from Rijeka to Ploče) and for Ship 3 it is 350km (from Rijeka to Split). The PTW emissions released during the ship operation are calculated according to eq. (4).

The environmental impact of a diesel engine was assessed considering the weight ratios of the material contents in the engine as proposed by Jeong et al. [39], Table 2. The parameters of the material manufacturing process are obtained from the GREET 2019 database.

Table 2 Material content of a typical marine engine [39]

Engine material	Weight ratios (%)
Cast iron	46.0
Steel	40.0
Aluminium	8.0
Oil and grease	3.0
Plastic	0.9
Rubber	0.9
Paint	0.9
Copper and Zinc	0.2
Lead	0.1

In order to calculate the weights of particular engine materials, these ratios were multiplied with the weight of the engine in tons, m , which is calculated with the following relation obtained from the study by Jeong et al. [39]:

$$m = \frac{2 \cdot P_{ave}}{450}, \quad (7)$$

where P_{ave} refers to the total average power of a ship. Since each power system configuration includes an engine (a diesel, dual-fuel or electric engine) and P_{ave} is equal for all the configurations, it is assumed that the environmental assessment of an engine for all considered configurations is the same as for the diesel engine.

2.2.3. The LCA of an electricity-powered ship

Environmental regulations, battery development and the increase in fossil fuel prices have opened the way for the electrification of ro-ro passenger ships. A fully electrified ship with a battery as the only power source installed on board leads to a reduction in emissions. This kind of power system configuration is investigated as an alternative for the Croatian short-sea shipping sector. Among various types of batteries, a Li-ion battery was selected. Even though it is relatively expensive, this battery has by far the highest energy density compared to other types and is the most prominent in marine applications [40][39]. The observed Li-ion battery with nickel manganese cobalt oxide (NMC) has energy density values of 0.15-0.22 kWh/kg [41]. The required battery capacity (BC) depends on the navigation route. It is assumed that the battery capacities for Ship 1 and Ship 2 are sufficient for operation on a round trip, while for Ship 3 the battery is assumed to be charged after a one-way trip. For safety reasons, the required capacities are increased by 20% and are calculated according to the equation:

$$BC = 1.2 \cdot EC \cdot (2) \cdot l, \quad (8)$$

where l refers to the route length of a one-way trip.

The LCA of an electricity-powered ship includes the electricity generation process (the WTP phase) and the processes of battery and electric engine manufacturing, Figure 5. For this power system configuration, the PTW emissions are equal to zero.

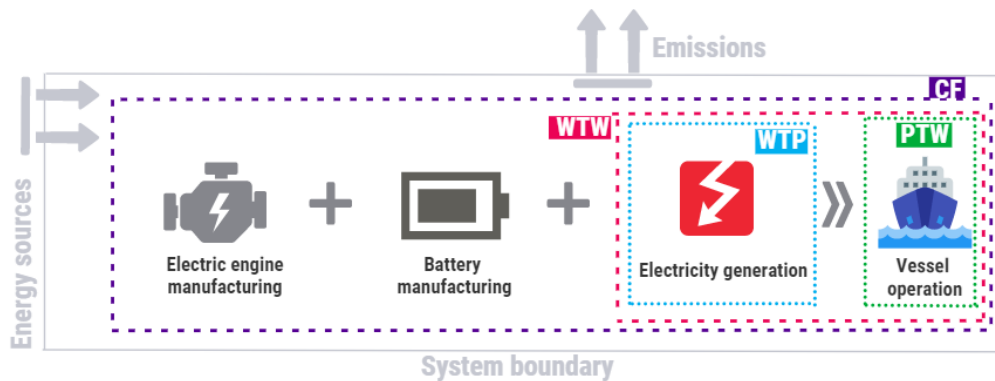

Figure 5 Processes included in the LCA of an electricity-powered ship

The environmental impact of the on-board battery was analysed through the Li-ion (NMC) battery manufacturing process obtained from the GREET 2019 database. The main input parameter is the weight of the battery and this is calculated by dividing the BC with the battery's specific energy, which equals 0.22 kWh/kg. Replacement of the battery after 10 years is also assumed. The environmental footprint of an electric engine is equal to the environmental footprint of a diesel engine from section 2.2.2. The WTP phase of electricity refers to the process of the generation of electricity. The structure of the Croatian electricity mix that is sold to end costumers is shown in Figure 6, where the main sources are fossil fuels, Renewable Energy Sources (RESs) and nuclear fuel [42].

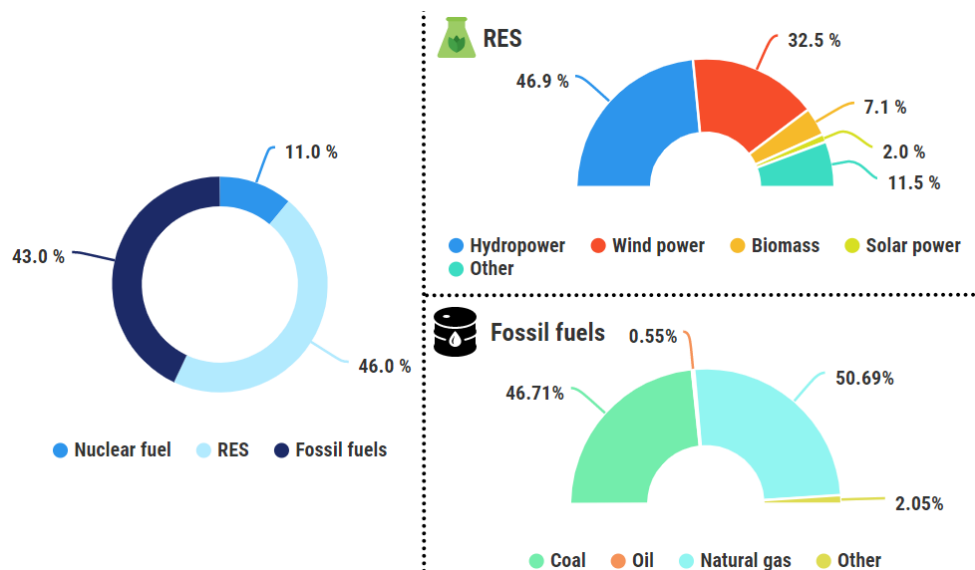

Figure 6 The Croatian electricity mix in 2018

2.2.4. The LCA of a methanol-powered ship

Methanol is a toxic, corrosive and sulphur-free fuel of fossil origin. The main feedstock for its production is natural gas. It has a carbon content of 38% which makes it attractive for use so as to comply with environmental protection regulations. For comparison, the carbon content of diesel is around 87%. Methanol is very similar to conventional marine fuels due to its liquid state. For this reason, it can be used in the current diesel infrastructure with minor modifications that are related to the problem of its low flash temperature (11 °C) which can be overcome by using a double-wall design [43]. This biodegradable and clean-burning fuel can easily be used in a commercially available MAN dual-fuel engine which operates on the diesel principle and uses a small amount of pilot fuel to initiate combustion [44].

For this assessment, it is assumed that ships operate only in a dual-fuel mode with 95% methanol and 5% diesel as pilot fuel. The power output of the dual-fuel engine corresponds to the total average ship power (P_{ave}). The specific consumption of methanol (SFC_M) is 327.2 g/kWh, while the specific consumption of pilot fuel (SFC_{P-M}) is equal to 10.1 g/kWh. These specific consumptions are related to a ship load of 75% [45].

The fuel consumptions of a methanol-powered ship are calculated by the following equations:

$$FC_M = x_M \cdot EC \cdot SFC_M, \quad (9)$$

$$FC_{P-M} = x_{P-M} \cdot EC \cdot SFC_{P-M}, \quad (10)$$

where FC_M and FC_{P-M} refer to the fuel consumption of methanol and pilot fuel, while x_M and x_{P-M} represent individual shares of methanol and pilot fuel in a dual-fuel engine, respectively. The LCA of a methanol-powered ship considers full emissions released from the processes shown in Figure 7, i.e. dual-fuel engine manufacturing, the WTP phases of methanol and diesel from section 2.2.2, and the combustion of fuels in a dual-fuel engine in the PTW phase.

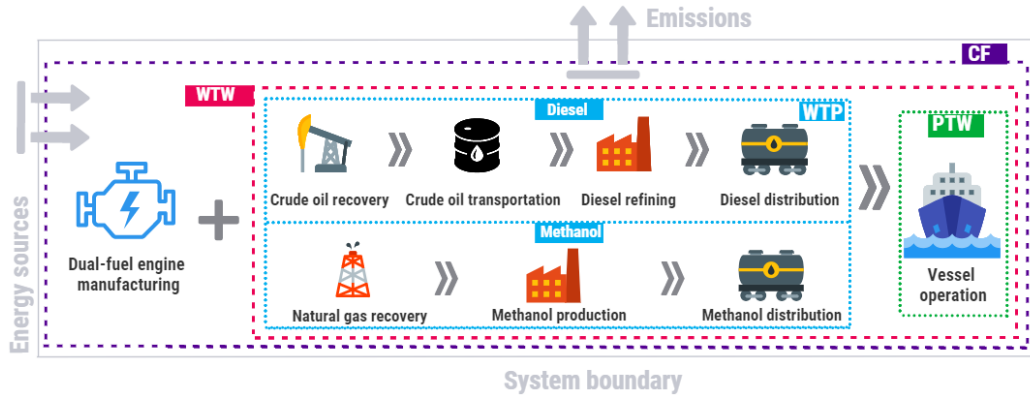

Figure 7 Processes included in the LCA of a methanol-powered ship

The environmental assessment of an engine is performed in the same way as for the diesel engine. The WTP phase of methanol includes natural gas recovery, the production of methanol and its transportation to the refuelling station. The methanol used in this assessment is produced from natural gas by steam reforming and is supplied only from the Egyptian production facility [46]. The transportation process of methanol is modified to methanol shipping via tanker to Croatia (3,000 km) and transport via tank truck to refuelling stations. This distance is different for each ship and corresponds to the distances for the transportation of diesel from section 2.2.2. The PTW emissions are calculated with the equation:

$$TE_i = EF_{M,i} \cdot FC_M + EF_{D,i} \cdot FC_{P-M}, \quad (11)$$

where EF_M and EF_D refer to the emission factor of methanol and diesel as pilot fuel for emission i (e.g. CO_2 , CH_4 , N_2O , etc). During the combustion of methanol, CH_4 and N_2O are not emitted in large quantities and are consequently excluded from the PTW phase [16].

2.2.5. The LCA of a DME-powered ship

DME is a high-density liquid fuel and is produced from the dehydration of methanol. In ambient conditions, it is in a gaseous state, and requires a pressure of 5 bar to stay in a liquid state but does not require cryogenic tanks. Since its properties are similar to those of propane, i.e. Liquefied Propane Gas (LPG), DME can be used in a propane infrastructure for storage and distribution [15]. Therefore, it can be used in a MAN dual-fuel engine designed for LPG [47]. For this assessment, it is assumed that ships operate only in a dual-fuel mode with 97% DME and 3% diesel as pilot fuel. The power output of the dual-fuel engine corresponds to the total average ship power (P_{ave}). Based on the NCV of DME (8.0 kWh/kg), it is assumed that the specific consumption of DME (SFC_{DME}) is 280 g/kWh and the specific consumption of pilot

fuel (SFC_{P-DME}) is equal to 8.5 g/kWh. The fuel consumptions of a DME-powered ship are calculated by the following equations:

$$FC_{DME} = x_{DME} \cdot EC \cdot SFC_{DME}, \quad (12)$$

$$FC_{P-DME} = x_{P-DME} \cdot EC \cdot SFC_{P-DME}, \quad (13)$$

where FC_{DME} and FC_{P-DME} refer to the fuel consumption of DME and pilot fuel, while x_{DME} and x_{P-DME} represent the individual proportions of DME and pilot fuel. The LCA of a DME-powered ship considers emissions released from the processes shown in Figure 8, i.e. dual-fuel engine manufacturing, the WTP phase of DME, the WTP phase of diesel from section 2.2.2, and the combustion of fuels in a dual-fuel engine in the PTW phase.

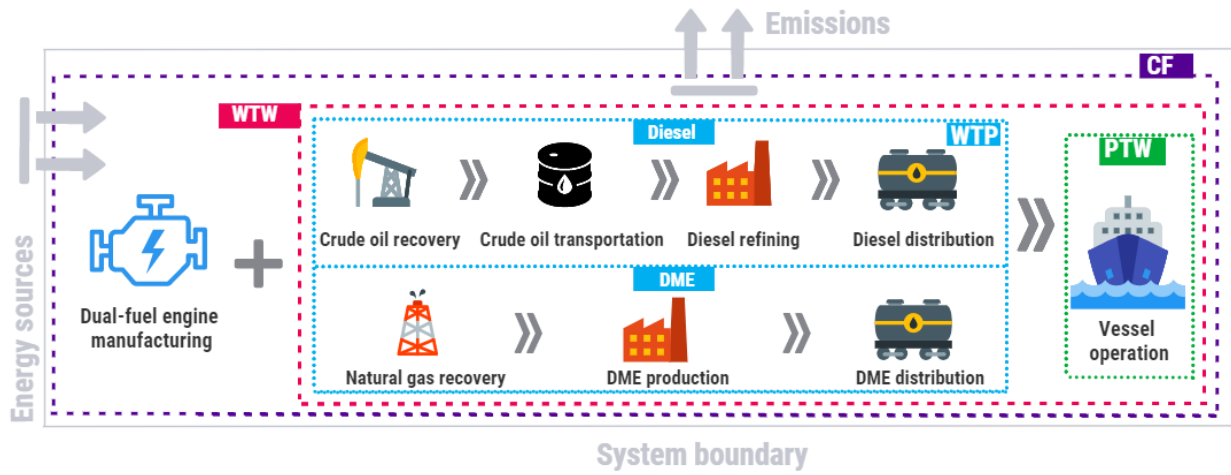

Figure 8 Processes included in the LCA of a DME-powered ship

The environmental assessment of an engine is performed in the same way as for the diesel engine. The WTP phase of DME includes natural gas recovery, the process of DME production with steam, and the distribution of fuel by using tank trucks (Ship 1: 1,100 km; Ship 2: 1,450 km; Ship 3: 1,350 km). The PTW emission released from a DME-powered ship is calculated with the following equation:

$$TE_i = EF_{DME,i} \cdot FC_{DME} + EF_{D,i} \cdot FC_{P-DME}, \quad (14)$$

where EF_{DME} and EF_D refer to the emission factors of DME and diesel as pilot fuel.

2.2.6. The LCA of a natural gas-powered ship

Even though it is a fossil fuel, natural gas is an abundant and affordable fuel whose lower carbon content (compared to diesel) represents a significant feature for the reduction of the CF. Its characteristics of being non-toxic, non-corrosive and odourless make it competitive on the energy market [48]. As a transportation fuel, natural gas can be used in the form of Compressed Natural Gas (CNG) or LNG [49]. Both options are investigated in this paper.

Nowadays, natural gas can be used in a mono-fuel gas engine (Otto cycle) or mixed with an inlet of air in a dual-fuel diesel engine, which provides higher efficiency than a mono-fuel engine [50]. The dual-fuel engine concept offers a smooth switch from one fuel (diesel) to another (natural gas) during ship operation without the loss of power or speed [51]. Specific consumption in the gas mode (specific consumption of natural gas (SFC_{NG}) + specific fuel consumption of pilot fuel (SFC_P)) for a load of 75% is equal to 7743 kJ/kWh [52]. Since pilot fuel is used in a proportion of 1% (x_{P-NG}), while the remaining proportion of 99% is natural gas (x_{NG}), the SFC_{NG} is 7,665.6 kJ/kWh (154.4 g/kWh), while the SFC_{P-NG} is 77.4 kJ/kWh (1.8 g/kWh). The fuel consumption of natural gas (FC_{NG}) and pilot fuel (FC_{P-NG}) is calculated by the following equations:

$$FC_{NG} = x_{NG} \cdot EC \cdot SFC_{NG}, \quad (15)$$

$$FC_{P-NG} = x_{P-NG} \cdot EC \cdot SFC_{P-NG}. \quad (16)$$

Even though Croatia has its own deposits of natural gas, they are insufficient for total demand and thus natural gas is imported, primarily from Russia [38]. After the recovery of Russian natural gas, it is transported by gas pipeline to refuelling stations where it is compressed into CNG. It is assumed that each considered mainland port has a CNG refuelling station. The transportation distance for Ship 1 is 2,200 km, for Ship 2 it is 2,550 km and for Ship 3 it is 2,450 km. The LCA of a CNG-powered ship includes the dual-fuel engine manufacturing, processes related to the diesel part of the configuration (from section 2.2.2), the processes related to the CNG, and ship operation during which PTW emissions are released, Figure 9.

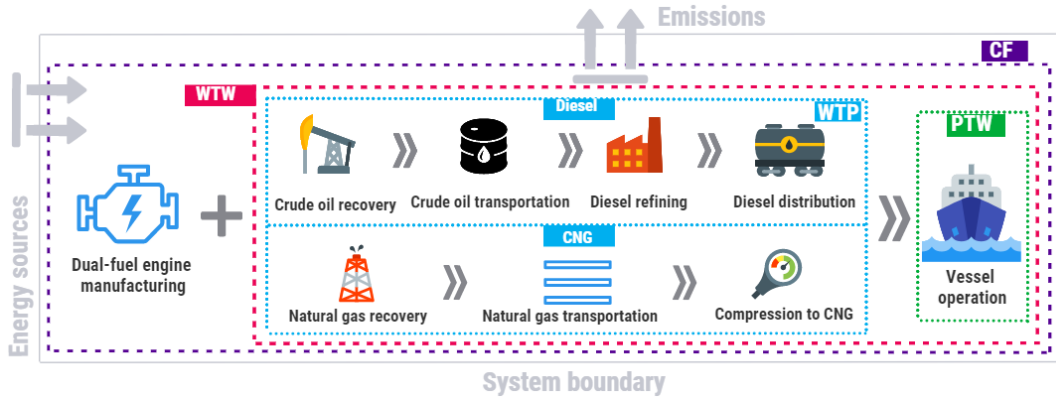

Figure 9 Processes included in the LCA of a CNG-powered ship

As a CNG, natural gas requires up to five times larger storage compared to liquid fossil fuel, while, when stored in LNG form, it takes two times larger storage compared to liquid fossil fuels[15]. Natural gas is originally in gaseous form, and, in order to make the handling process easier, it is liquefied by cooling to -163°C . LNG has 600 times less volume than in its gaseous state [53]. Since the most important European LNG supplier is Qatar [54], for this assessment it is assumed that LNG is transported from there and that the liquefaction process is performed on the site of recovery. Transportation of LNG from Qatar is done by LNG carriers that transport fuel for around 7,000 km to Croatia. The processes included in the LCA of an LNG-powered ship are presented in Figure 10.

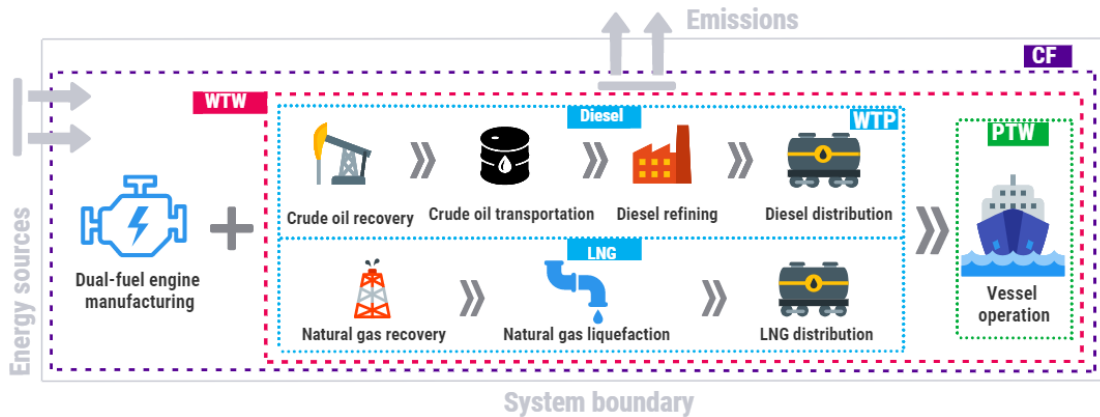

Figure 10 Processes included in the LCA of an LNG-powered ship

The PTW emissions released from both natural gas configurations are the same and are calculating according to the following equation:

$$TE_i = EF_{NG,i} \cdot FC_{NG} + EF_{D,i} \cdot FC_{P-NG}, \quad (17)$$

where EF_{NG} and EF_D refer to the emission factors of natural gas and pilot fuel (diesel).

2.2.7. The LCA of a hydrogen-powered ship

One of the alternative fuel candidates providing clean energy generation on board is hydrogen, a non-toxic, odourless and colourless gas that is abundant, but can rarely be found in a pure form. It generates more energy per mass compared to conventional fuels used for shipping. The most common way of obtaining hydrogen is from natural gas, but it can also be obtained from biomass and by electrolysis [55]. The drawback of using hydrogen is its low storage density. Since it can be produced from hydrogen carriers, on-board production seems to be cheaper and more efficient than the production of hydrogen elsewhere [21]. A fuel cell can use renewable hydrogen produced by water electrolysis, i.e. the electrochemical process of splitting water into hydrogen and oxygen carried out in an electrolyser which uses electricity for that production [56]. In this paper, two hydrogen power system configurations are investigated. In the first one, renewable hydrogen is produced by an electrolyser which is powered by a Li-ion battery. After the production of hydrogen, fuel enters a tank from which it is fed to a Proton Exchange Membrane (PEM) fuel cell with platinum electrodes, while the electrolyte is an ion-exchange membrane. The operating temperature is low, between 65-85 °C, and it needs to remain below 100 °C due to water which is produced on the cathode. This type of fuel cell is intolerant of impurities (CO can be harmful to the platinum catalyst) and needs to be fed by pure hydrogen [57]. Even though the literature investigates the application of fuel cells only as an auxiliary power source in the marine sector, here, for comparative purposes, its use for ship propulsion is considered. The system parameters and costs are obtained from [58]. Electricity produced by a fuel cell is used to power the electric engine, whose power output is equal to the total average power (P_{ave}) of the considered ship. The observed system is presented in Figure 11.

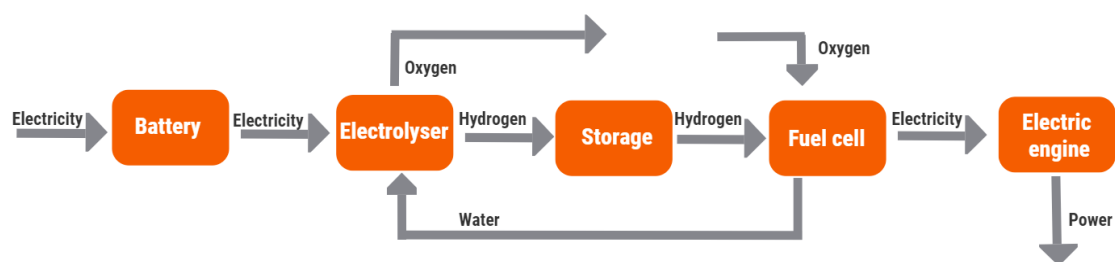

Figure 11 Renewable hydrogen-powered ship system configuration

In order to cover the ship's energy needs, by considering an efficiency of 48% (η_{FC}) [59], the PEM fuel cells of a certain power are selected: for Ship 1, a PEM fuel cell of 776 kW, while Ship 2 and Ship 3 are powered by PEM fuel cells of 1,772 kW and of 5,355 kW,

respectively. Taking into account the energy consumption of a ship (EC), the net calorific value of hydrogen (NCV_H) which yields 33.3 kWh/kg and η_{FC} , the hydrogen consumption (FC_H) per nautical mile is calculated as follows:

$$FC_H = \frac{EC}{\eta_{FC} \cdot NCV_H} \quad (18)$$

In order to ensure enough hydrogen to power a ship, the produced amount of hydrogen corresponds to the FC_H value that is increased by 0.5 kg/nm. Electricity consumption (E) required for the production of hydrogen is calculated according to the following equation:

$$E = \frac{0.5 + FC_H \cdot NCV_H}{\eta_{EL}}, \quad (19)$$

where η_{EL} refers to the efficiency of the electrolyser (90%) [58]. Battery capacity is calculated according to eq. (8), while water consumption is equal to 15 L/kg of the hydrogen produced [60]. Electrolysers of 500 kW (Ship 1), 1000 kW (Ship 2) and 2,000 kW (Ship 3) were selected. The LCA of a renewable hydrogen-powered ship takes into account the WTP phase of electricity (section 2.2.3), the battery/electrolyser/PEM fuel cell/electric engine manufacturing processes, and ship operation, during which there are no tailpipe emissions, Figure 12.

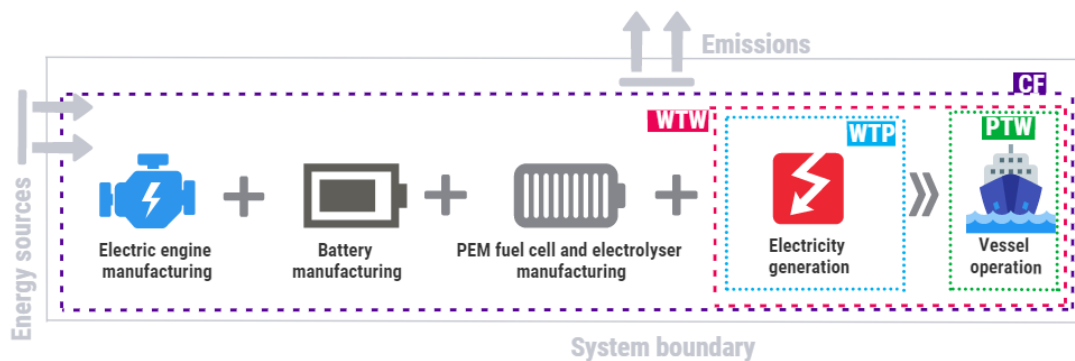

Figure 12 Processes included in the LCA of a renewable hydrogen-powered ship

The environmental impact of an electrolyser and fuel cell are described in GREET 2019 by using the weights of materials used in the electrolyser [61] and PEM fuel cell [62], while the battery manufacturing process is obtained from section 2.2.3. These elements are replaced according to their predicted lifetime (electrolyser: 15 years; fuel cell: 50,000 hours ~ 13 years; battery: 10 years).

The second hydrogen power system configuration is a fossil hydrogen-powered ship which refers to supplying the PEM fuel cell with hydrogen produced from natural gas off board. The energy needs, hydrogen consumption, fuel cell and environmental impacts of a fuel cell

and electric engine remain the same as for a renewable hydrogen-powered ship. Even though Croatia has not developed a hydrogen market, it is assumed that hydrogen is produced in Western Europe and transported to Croatia. After production, liquefied hydrogen is transported via tank trucks (Ship 1: 1,100 km; Ship 2: 1,450 km; Ship 3: 1,350 km). The LCA of a fossil hydrogen-powered ship consists of the manufacturing process of a fuel cell and an electric engine, natural gas recovery, hydrogen production and its liquefaction, distribution of hydrogen via tank trucks, hydrogen storage and compression on board, and vessel operation during which there are no tailpipe emissions released, Figure 13.

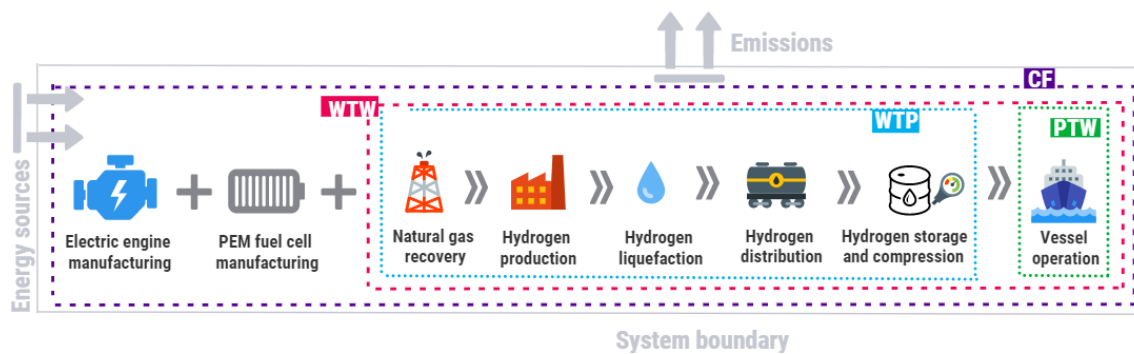

Figure 13 Processes included in the LCA of a fossil hydrogen-powered ship

2.2.8. The LCA of a B20-powered ship

The most frequently produced biofuel is biodiesel: a non-toxic, biodegradable and versatile fuel, which, because of its properties similar to those of diesel, can be used in a diesel engine without modifications of the power system infrastructure. Pure biodiesel contains 100% biodiesel and is denoted as B100, while biodiesel blends with fossil fuel are designated as BXX, where XX indicates the biodiesel percentage in the blend. For example, B20 contains 20% biodiesel and 80% fossil fuel [63]. Biodiesel feedstock can be classified into four main groups: edible vegetable oil (soybean, rapeseed, sunflower, palm, etc), non-edible vegetable oil (algae, cotton seed, pongamia, etc.), recycled and waste oil, and animal fat [64].

In this paper, the soybean-biodiesel-diesel blend B20 is considered, and it is assumed that for each ship, energy and fuel consumption are the same as for a diesel-powered ship. Diesel used in a blend is considered in section 2.2.2, while soybean-biodiesel is imported from Italy, from the Veneto region where soybeans are grown and processed into biodiesel [65]. The WTP phase of biodiesel consists of several processes: soybean farming and soy oil extraction,

transportation of soy oil by tank trucks (assumed: 50 km) to the plant where transesterification occurs and where the biodiesel is produced. Biodiesel is transported by tank trucks to the refuelling station where it is assumed that the biodiesel and diesel are mixed. Transportation distances are different for each considered ship: 350 km (Ship 1), 700 km (Ship 2) and 600 km (Ship 3). The performed LCA of a B20-powered ship includes the processes presented in Figure 14. The environmental assessment of a diesel engine is obtained from section 2.2.2.

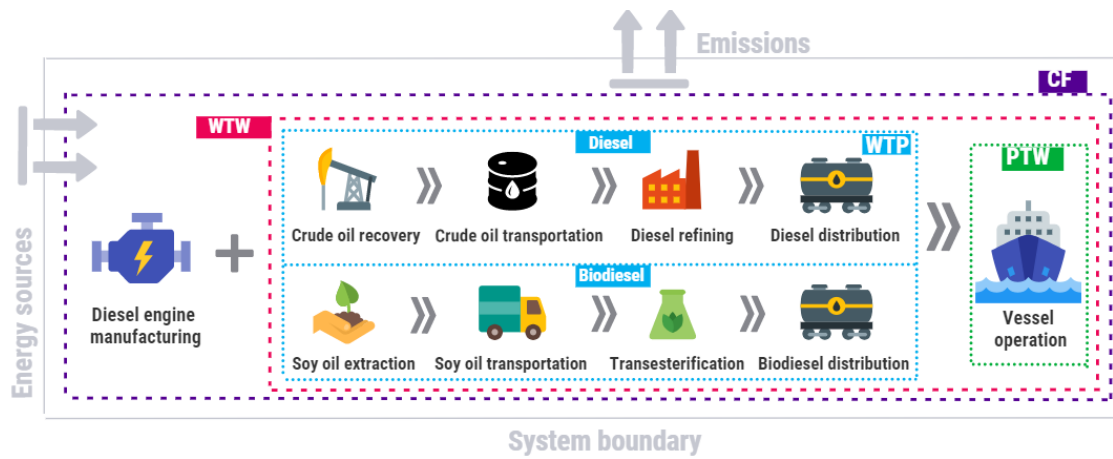

Figure 14 Processes included in the LCA of a B20-powered ship

PTW emissions depend on the blend. Since this one is 80% diesel and emissions released from biodiesel consumption are not taken into account, the tailpipe emissions are calculated by the following equation:

$$TE_i = 0.8 \cdot FC_{B20} \cdot EF_{D,i}, \quad (20)$$

where FC_{B20} is the fuel consumption of a B20-powered ship, subscript i refers to any emission, and EF_D denotes the emission factor for diesel.

2.3. LCCA

2.3.1. General

In order to provide insight into the cost effectiveness of different power system configurations featuring different alternative fuels, LCCAs were performed where the total life-cycle costs of these configurations during the ship lifetime are considered. The total costs of a power system configuration include the investment cost and exploitation costs, Figure 15.

Total costs

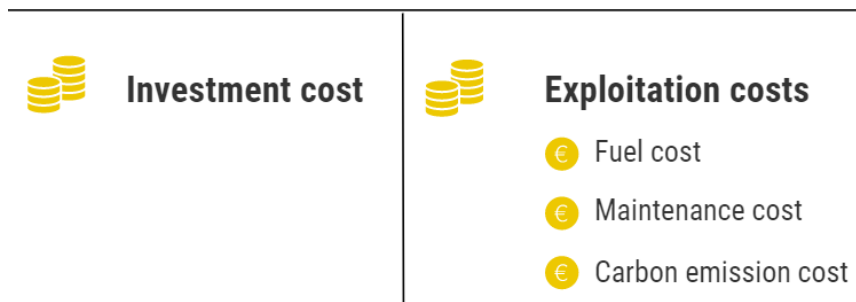

Figure 15 Total costs of a ship power system configuration

The investment cost refers to the capital cost of a power system configuration (e.g. engine price, conversion price, battery price, etc.), while the exploitation costs include three types of costs: the cost of the fuel used in the power system, the maintenance cost accompanied by the replacement cost of the main part of the power system, and the carbon emission cost.

The carbon emission cost refers to the cost of a permit to emit CO₂ emissions (i.e. carbon allowance) which can be received or bought and even traded. Each allowance gives the right to emit 1 ton of CO₂ or the equivalent amount of two more powerful GHGs (N₂O and perfluorocarbons). Even though it has not yet been implemented in the shipping industry, some sectors have already implemented it (industry, aviation, electric power sectors) [66]. However, since the shipping sector is forced to reduce its CF, it is reasonable to expect these costs in this sector in the near future. Therefore, its implementation should be considered from the point of view of different scenarios, such as in the study of Trivyza et al. [67], where four scenarios are analysed. The forecast carbon allowance (CA) values for 2030 and 2040 in the European Union, for each scenario, are obtained from the World Energy Outlook 2019 [68] and the interpolation of these values gives the annual carbon allowances. For 2020, the CA is zero, since it is still not implemented, Figure 16. Four scenarios include the non-taxation (NT) scenario (the carbon emission cost is not implemented) and three carbon scenarios:

- The Current Policies (CP) scenario: consideration of the current policies implemented in the energy sector, without additional changes in the future;
- The Stated Policies (SP) scenario: current policies and today's policy intentions and targets;

- The Sustainable Development (SD) scenario: the strategic pathway to meet global climate, air quality and energy access goals.

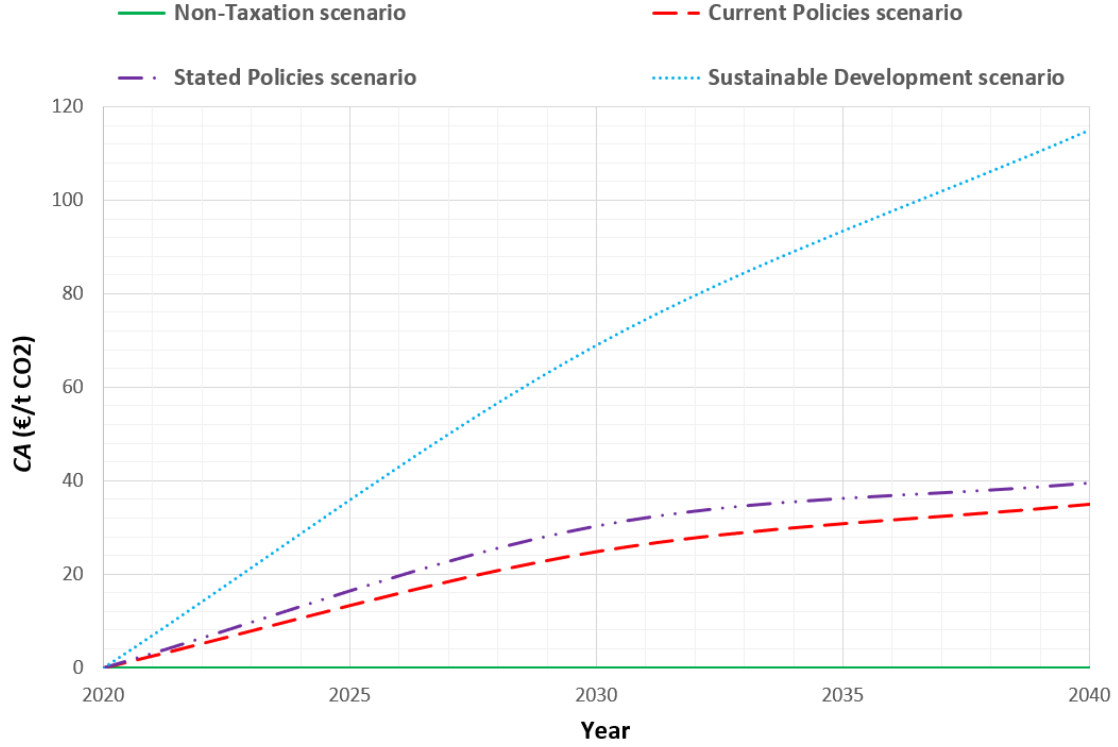

Figure 16 Carbon allowance scenarios

Since the carbon allowance refers to permission to emit CO₂ emissions during ship navigation, these scenarios are illustrated only in power system configurations with tailpipe emissions, i.e. the electricity-powered ship and a hydrogen-powered ship are excluded from the implementation of the carbon emission cost. The life-cycle carbon emission cost (*LCCEC*) for different scenarios is calculated in the same way, according to the following equation:

$$LCCEC = \sum_{i=1}^{20} PTW_{A,i} \cdot CA_i, \quad (21)$$

where i refers to one year in the ship lifetime, $PTW_{A,i}$ refers to annual tailpipe emissions in t CO₂-eq, while CA_i refers to the carbon allowance for year i .

2.3.2. The LCCA of a diesel-powered ship

The investment cost of a new diesel engine on each considered ship is calculated by multiplying the average power of the ship with the assumed conversion factor of 250 €/kW.

The Croatian diesel fuel price (PR_D) that takes into account the reduction of excise duty is equal to 0.66 €/l, i.e. 0.78 €/kg [69]. The life-cycle fuel cost ($LCFC_D$) is calculated according to the following equation:

$$LCFC_D = LM \cdot FC_D \cdot PR_D, \quad (22)$$

where LM refers to the lifetime mileage and FC_D denotes the fuel consumption of a diesel-powered ship. The maintenance cost of a diesel-powered ship is assumed to be 0.014 €/kWh, as proposed by Iannaccone et al. [70] for the maintenance cost of a ship powered by marine gas oil. The life-cycle maintenance cost is calculated according to:

$$LCMC_D = LM \cdot EC \cdot 0.014, \quad (23)$$

where EC refers to the energy consumption of the ship. The carbon emission cost is calculated by eq. (21).

2.3.3. The LCCA of an electricity-powered ship

One of the obstacles that postpone the large-scale implementation of Li-ion batteries is their high capital cost. The retrofitting of a ship with a battery results in an investment cost of which 45% relates to the battery price, while the rest represents installation, electric engine and additional equipment costs [71]. Based on this relation, the investment cost of an electricity-powered ship (IC_E) is calculated by the following equation:

$$IC_E = \frac{BC \cdot PR_B}{0.45}, \quad (24)$$

where BC represents the battery capacity calculated according to eq. (8), while PR_B refers to the battery price which is assumed to be 200 €/kWh [72]. Since the electricity price (PR_E) for Croatian medium-sized industry is 78 €/MWh [69], the life-cycle electricity cost ($LCFC_E$) of an electricity-powered ship is calculated according to the following equation:

$$LCFC_E = LM \cdot EC \cdot PR_E, \quad (25)$$

where LM denotes the lifetime mileage and EC refers to the energy consumption of the ship. The maintenance cost for this configuration refers to the replacement cost of a battery after 10 years of use. The forecast Li-ion battery price for electric vehicles [72] for 2030 is set at 169 €/kWh ($PR_{B,2030}$), which is then multiplied by the battery capacity in order to calculate the total maintenance cost:

$$LCMC_E = BC \cdot PR_{B,2030} \quad (26)$$

2.3.4. The LCCA of a methanol -powered ship

Replacing a diesel power system with a methanol power system yields an investment cost which is calculated by multiplying the average ship power with the conversion rate of 750 €/kW for a new-build system which takes into account the purchase of a new engine (20 years of life) and associated equipment [73]. It is assumed that the life-cycle maintenance cost of a methanol-powered ship is equal to the life-cycle maintenance cost of a diesel-powered ship. By taking into account the diesel price (PR_D) from section 2.3.2, and the methanol price (PR_M) of 0.325 €/kg, which is calculated by adding the Croatian VAT of 25% to the price set by the producer, i.e. 0.26 €/kg [46], the life-cycle fuel cost is calculated by the following equation:

$$LCFC_M = LM \cdot (FC_M \cdot PR_M + FC_{P-M} \cdot PR_D), \quad (27)$$

where LM represents the lifetime mileage, while FC_M and FC_{P-M} refer to the fuel consumption of methanol and pilot fuel. Carbon emission costs are calculated with eq. (21).

2.3.5. The LCCA of a DME-powered ship

It is assumed that the investment and maintenance costs of a DME-powered ship correspond to the investment and maintenance costs of a methanol-powered ship from section 2.3.4. Since DME is in essence dehydrated methanol, its assumed price refers to the methanol price of 0.325 €/kg (PR_{DME}). By taking into account the diesel price (PR_D) from section 2.3.2, the life-cycle fuel cost is calculated by the following equation:

$$LCFC_{DME} = LM \cdot (FC_{DME} \cdot PR_{DME} + FC_{P-DME} \cdot PR_D), \quad (28)$$

where LM represents the lifetime mileage, while FC_{DME} and FC_{P-DME} refer to the fuel consumption of DME and pilot fuel. Carbon emission costs are calculated with eq. (21).

2.3.6. The LCCA of a natural gas-powered ship

The conversion rate for a newly built LNG system is around 1,160 €/kW and, in that cost, the engine and all additional equipment such as the storage tank are included [73]. Since the CNG power system does not require cryogenic tanks and other equipment that the LNG

power system needs, it is assumed that for the newly built CNG power system the conversion rate is equal to 60% of the conversion rate for the LNG power system t , i.e. around 700 €/kW. By multiplying the conversion rates with the engine power, Table 2, the investment costs are calculated. The European price for 1 kg of LNG varies from 0.95 € to 1.1 €. In this paper, LNG costs 1.1 €/kg (PR_{LNG}), while the Croatian CNG price is 1.34 €/kg (PR_{CNG}) [74]. The life-cycle CNG cost for each ship is calculated by eq. (29), while the life-cycle LNG cost is calculated by eq. (30):

$$LCFC_{CNG} = LM \cdot (FC_{NG} \cdot PR_{CNG} + FC_{P-NG} \cdot PR_D), \quad (29)$$

$$LCFC_{LNG} = LM \cdot (FC_{NG} \cdot PR_{LNG} + FC_{P-NG} \cdot PR_D), \quad (30)$$

where LM refers to the lifetime mileage, FC_{NG} and FC_{P-NG} refer to the fuel consumption of natural gas (either CNG or LNG) and pilot fuel, while PR_D denotes the diesel price from section 2.3.2. The maintenance cost of LNG technology equals 0.015 €/kWh [70]. The life-cycle maintenance cost of an LNG-powered ship ($LCMC_{LNG}$) is calculated by the equation:

$$LCMC_{LNG} = LM \cdot EC \cdot 0.015, \quad (31)$$

where EC refers to the energy consumption of the ship. The life-cycle maintenance cost of a CNG-powered ship is assumed to be 60% of $LCMC_{LNG}$. The carbon emission cost for each power system configuration is calculated by eq. (21).

2.3.7. The LCCA of a hydrogen-powered ship

The main reason why fuel cell systems do not have wide application is their very high investment costs. The investment cost for a renewable hydrogen-powered ship consists of the capital cost of a PEM fuel cell (368 €/kW), an electrolyser (92 €/kW) [58], and a battery whose investment cost is calculated by eq. (24). The life-cycle electricity cost for a renewable hydrogen-powered ship is calculated by eq. (25) where the energy consumption of a ship is replaced with electricity consumption (E) by an electrolyser. Even though water is used in the process of electrolysis, its cost is negligible since the water produced in the fuel cell returns to the electrolyser and is again used in the hydrogen production. For reasons of simplicity, the maintenance cost refers only to the replacement cost. The battery replacement cost is calculated according to eq. (26), while the replacement costs of the PEM fuel cell and electrolyser are the same as for the investment costs.

The investment cost of a fossil hydrogen-powered ship is the capital cost of a PEM fuel cell which is increased by 50% in order to take into account a hydrogen tank and other required equipment. The maintenance cost refers only to the cost of fuel cell replacement, while the life-cycle fuel cost for each ship is calculated according to the following equation:

$$LCFC = LM \cdot FC_H \cdot PR_H, \quad (32)$$

where LM denotes the lifetime mileage, FC_H refers to the consumption of hydrogen, while PR_H represents the hydrogen price which is equal to 9.5 €/kg [75].

2.3.8. The LCCA of a B20-powered ship

The application of B20 does not require the modification of a diesel infrastructure. Therefore, the maintenance and investment costs of a B20-powered ship are the same as for a diesel-powered ship. Since in Croatia there are no more subsidies for using biodiesel as a fuel, the price of pure diesel is assumed to be the same as the regular price of Croatian diesel, i.e. 1.48 €/kg [69]. The life-cycle fuel cost ($LCFC_{B20}$) is then calculated considering the diesel price (PR_D), the biodiesel price (PR_{BD}), the lifetime mileage (LM), the fuel consumption of a B20-powered ship (FC_{B20}), and the proportions of individual fuels in the blend (x_D and x_{BD}):

$$LCFC_{B20} = LM \cdot FC_{B20} \cdot (x_D \cdot PR_D + x_B \cdot PR_{BD}). \quad (33)$$

The carbon emission cost is calculated according to eq. (21).

3. Results

Environmental and economic assessments of ship power systems with different alternative fuels were performed for the case of the Croatian short-sea shipping fleet. In Table 3, the properties of the investigated fuels are presented (except electricity). Due to similar properties, it is assumed that the NCV of biodiesel is the same as for diesel. The emission factors for diesel and natural gas are obtained from the Third IMO GHG Study [5], while the one for methanol is obtained from the Study on the Use of Ethyl and Methyl Alcohol as Alternative Fuels in Shipping, prepared for the European Maritime Safety Agency (EMSA) [73]. The emission factors for DME combustion are obtained in units of CO_2 -eq and are equal to around 66 g CO_2 -eq/MJ, i.e. 1,927 g/kg DME [76].

Table 3 Marine fuel properties

GHG	GWP	Emission factors (g/kg fuel)	Diesel	Natural gas	Methanol	DME	Hydrogen	B20
CO ₂	1		3,206	2,750	1,380	1,927	-	-
CH ₄	25		0.06	51.2	-		-	-
N ₂ O	298		0.15	0.11	-		-	-
NCV (kWh/kg)			11.83	12.9	5.55	8.0	33.3	11.83

Table 4 contains the calculated data from the technical analysis of the selected ships.

Table 4 Calculated data for the selected ship with a diesel power system configuration

	Ship 1	Ship 2	Ship 3
Average speed, v_{ave} (kn)	6.44	8.15	12.94
Average main engine(s) power, $P_{ME,ave}$ (kW)	330.52	410.53	1,598.24
Average auxiliary engine(s) power, $P_{AE,ave}$ (kW)	42.00	420.00	972.00
Total average ship power, P_{ave} (kW)	372.52	830.53	2,570.24
Lifetime mileage, LM (nm)	102,396	567,240	966,400
Energy consumption per distance, EC (kWh/nm)	57.85	101.91	198.58

Tailpipe emissions are released during ship operation, except for the operation of an electricity-powered ship and a hydrogen-powered ship. The results of the LCA comparison is presented in Figure 17, where D denotes diesel, E denotes electricity, M refers to methanol, NG refers to natural gas, RH represents renewable hydrogen, while FH represents fossil hydrogen.

After the environmental assessment of different alternative fuels in power systems installed on board Croatian ro-ro passenger ships, an insight into their cost-effectiveness was provided with the performed LCCA comparison. A link between the LCA and LCCA is the annual tailpipe emissions, i.e. PTW emissions, which are used to calculate the carbon emission cost over the ship's lifetime, i.e. LCCEC. The calculated carbon emission cost for all scenarios is presented in Table 5, while the LCA and LCCA results are shown in Figure 17, taking into account the SD scenario as a carbon allowance scenario.

Table 5. Carbon emission costs for different scenarios and different ships

	Ship 1				Ship 2				Ship 3			
	PTW_A (t CO ₂ -eq)	LCCEC (mil. €)			PTW_A (t CO ₂ -eq)	LCCEC (mil. €)			PTW_A (t CO ₂ -eq)	LCCEC (mil. €)		
	CP	SP	SD	CP	SP	SD	CP	SP	SD	CP	SP	SD
D	201.9	0.08	0.10	0.24	2,021	0.82	0.97	2.44	6,709	2.72	3.23	8.10
M	127.5	0.05	0.06	0.15	1,244	0.50	0.60	1.50	4,132	1.68	1.99	4.99
DME	153.29	0.06	0.07	0.18	1,496	0.61	0.72	1.81	4,967	2.01	2.40	5.99
NG	183.9	0.07	0.09	0.22	1,795	0.73	0.86	2.18	5,959	2.42	2.87	7.19
B20	165.7	0.07	0.08	0.20	1,616	0.65	0.78	1.95	5,367	2.18	2.58	6.48

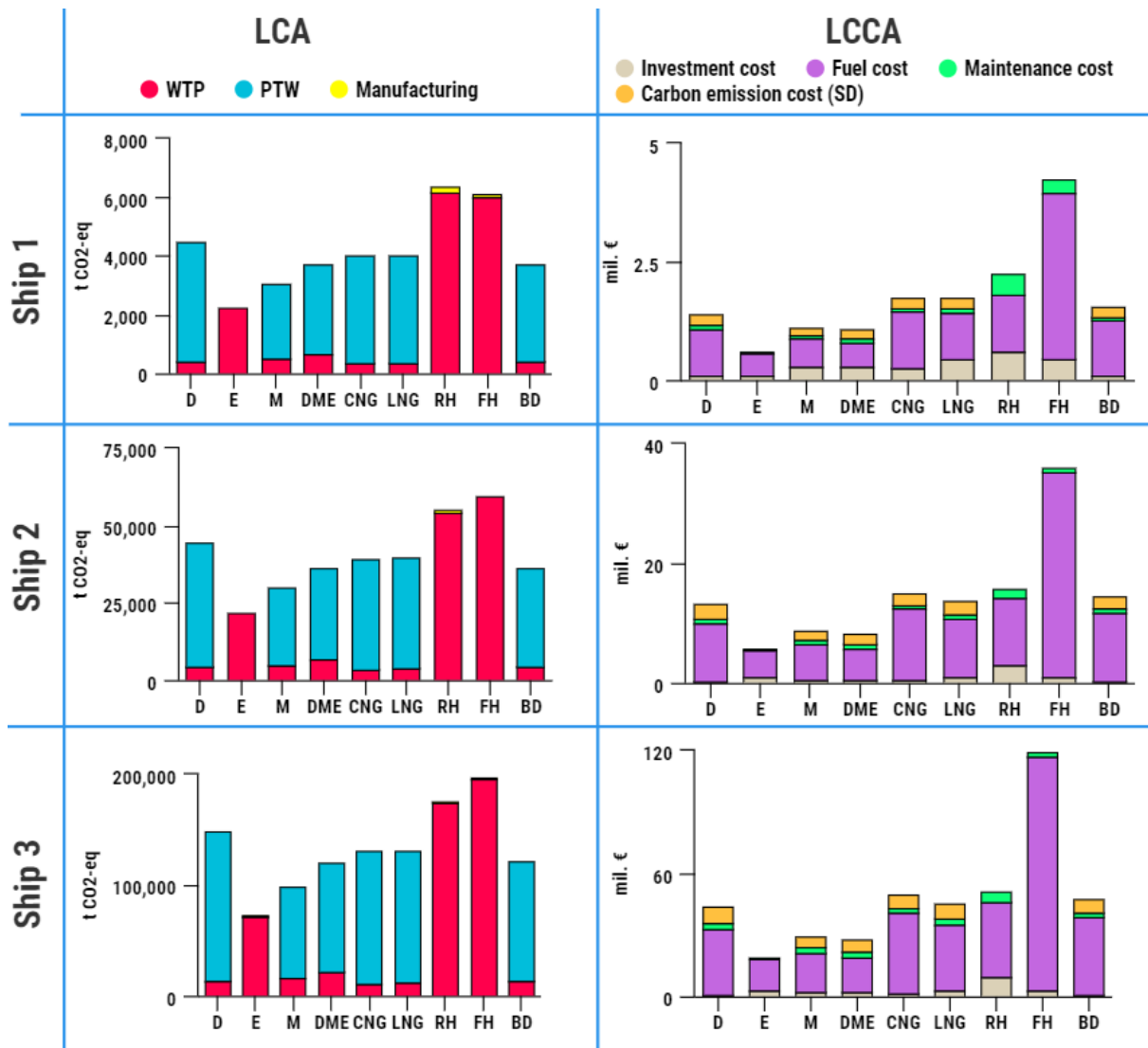

Figure 17 The LCA and LCCA comparison of alternative fuels for a ship lifetime of 20 years

4. Discussion

The LCA results show that the most environmentally friendly option for each considered ship is the replacement of the current diesel configuration of the ship power system with a battery. The CF of an electricity-powered ship is constituted by emissions related only to electricity generation and battery manufacturing and is around 50% lower than the CF of the investigated diesel-powered ships. Ship 1 and Ship 2 operate on relatively shorter routes and their batteries can be recharged after a round trip, which is not the case for Ship 3 whose battery is recharged after a one-way trip. If the battery on board Ship 3 is recharged after a round trip, its required capacity would be twice its current value. Even though this would not so much

affect the environmental assessment, the electricity power system configuration for Ship 3 would still be the most environmentally friendly solution for the replacement of a diesel power system whose investment and maintenance costs would be 50% higher. This also applies to a renewable hydrogen-powered ship, which proved to be one of the power system configurations with the highest emissions among those investigated in this paper. Most of these emissions are related to electricity generation, which is required for the on board production of hydrogen. Electricity used on board to produce hydrogen or to supply the ship with power can be more environmentally friendly if the energy sources used for its generation mostly consist of RESs. In the literature, fuel cell systems are usually used as an auxiliary power system fuelled with hydrogen produced by electricity obtained from RESs, i.e. photovoltaic (PV) cells or wind turbines installed on board. If 30% of the required electricity is obtained from the PV cells, the WTP emissions of electricity would be 30% lower, as would the battery capacity. Therefore, fuel cells are not the preferred choice from the environmental point of view, unless the ship operates on a shorter route with renewable electricity generation on board and with the use of fuel cells as an auxiliary power system only. Hydrogen production from fossil fuel, i.e. natural gas, has had an effect on its use in the marine sector. The emissions released from the WTP of hydrogen represents a major part of the total CF. For Ship 1, the CF of a hydrogen-powered ship is lower than the CF of a renewable hydrogen-powered ship, while for Ship 2 and Ship 3 the reverse is true. One of the benefits of this configuration is that there are no tailpipe emissions. However, the WTP emissions are not negligible, and this configuration does not comply with the environmental requirements that need to be met in the replacement of a diesel-powered ship.

The comparative LCA also indicated that replacing diesel with methanol is the second most environmentally friendly option. Even though during the operation of a methanol-powered ship, tailpipe emissions are released, and the fuel consumption is higher than that of a diesel-powered ship (due to methanol's lower *NCV*), methanol has lower carbon content which results in an approximately 32-33% lower CF compared to a diesel power system configuration for each investigated ship. Another fuel that satisfies the criteria of not having a higher CF than the currently used diesel-powered ships is DME. A power system configuration with DME has slightly higher emissions than a methanol-powered ship but lower emissions than the natural gas options. The CFs of CNG and LNG have proven to be approximately 10-12% lower than the CF of diesel power system configurations, which indicates their potential for application on board Croatian ro-ro passenger ships. It can be noticed that the WTP emissions of CNG and

LNG are slightly different, due to different WTP pathways, and that CNG has a slightly better environmental impact than LNG. Biodiesel from soybeans and diesel blended together in a B20 fuel showed a lower CF compared to a diesel power system configuration. The WTP emissions are higher than the WTP emissions of a diesel-powered ship, but the PTW emissions released with the combustion of a B20 blend are lower, since, given that it is generally held that biofuels are “carbon neutral”, the emissions of biodiesel were not included in the assessment. This configuration yields a CF reduction of around 16-18% compared to the investigated diesel-powered ships, which is still lower than the natural gas power system configurations.

Since the SD scenario represents the most rigorous scenario, it has been selected for the presentation of the overall life-cycle results in Figure 17. For illustration, *LCCECs* according to other scenarios are presented in Table 5.

According to the LCCA results, three power system configurations are cost-effective for the replacement of the diesel-powered ship: a methanol-powered ship, a DME-powered ship and an electricity-powered ship. The most environmentally friendly and also the most economical solution is the replacement of a diesel-powered ship with a battery. The total life-cycle costs of this configuration are around 56% lower than the costs of the current power system installed on the considered ships. If the battery installed on Ship 3 was recharged after a round trip, the battery capacity would need to be twice as big, which would have higher costs as a consequence. However, this configuration would still satisfy the economic criteria since the life-cycle cost would be around 45% lower than the life-cycle cost of Ship 3 powered by diesel. The payback period of the electric power system is around four years for each of the considered ships. In the case of Ship 3, if the battery is recharged after a round trip, the payback period is within six years.

5. Interpretation

Based on the presented results, an electricity-powered ship represents the most cost-effective and environmentally friendly power system configuration that can be used as a replacement for the diesel power system configuration on the considered ships. Although the operation of an electricity-powered ship can be treated as zero-emission, the total CF of such a ship is directly dependent on the energy mix of a country. Three different scenarios with different electricity mixes are observed to describe the effect of power origin (fossil/renewable)

on the total CF of an electricity-powered ship, where Ship 2 operating on the medium route is taken as a test case, Figure 18.

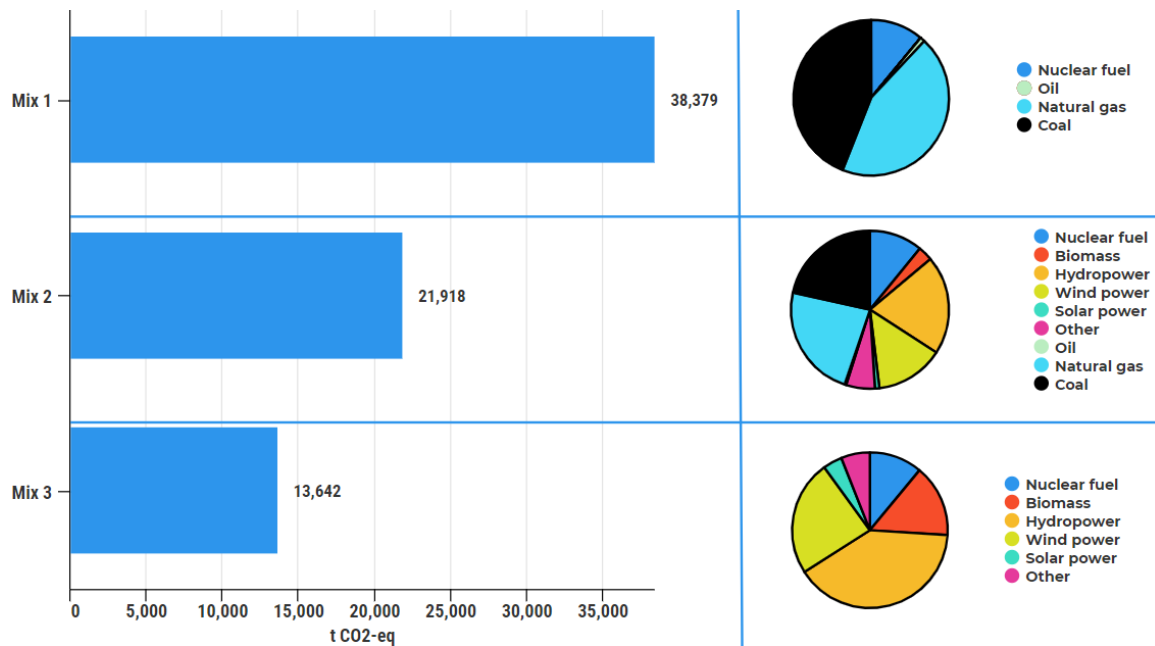

Figure 18 The CF of an electricity-powered ship (Ship 2) with different electricity mixes

Mix 1 refers to the Croatian electricity mix with no renewable sources, while Mix 3 represents the Croatian electricity mix with no fossil fuel for electricity production, and Mix 2 corresponds to the original Croatian electricity mix, Figure 6. The total CF of the entire power system configuration during the ship lifetime of 20 years is lowest when Mix 3 is used, while it is higher when there are no renewable sources used for electricity generation (Mix 1). It can be concluded that even though the electrified ship offers zero-emission shipping, the emissions from the process of electricity generation are not negligible. While most of the alternative fuels investigated for shipping purposes are still of fossil origin, the alternative fuels obtained from renewable sources represent an attractive area of research, particularly, due to the depletion of fossil fuel, when the global community needs to focus on biofuels. Methanol and DME obtained from fossil natural gas and biomass are investigated and their emissions are presented in Figure 19. These emissions are also related to the power system configurations implemented on Ship 2.

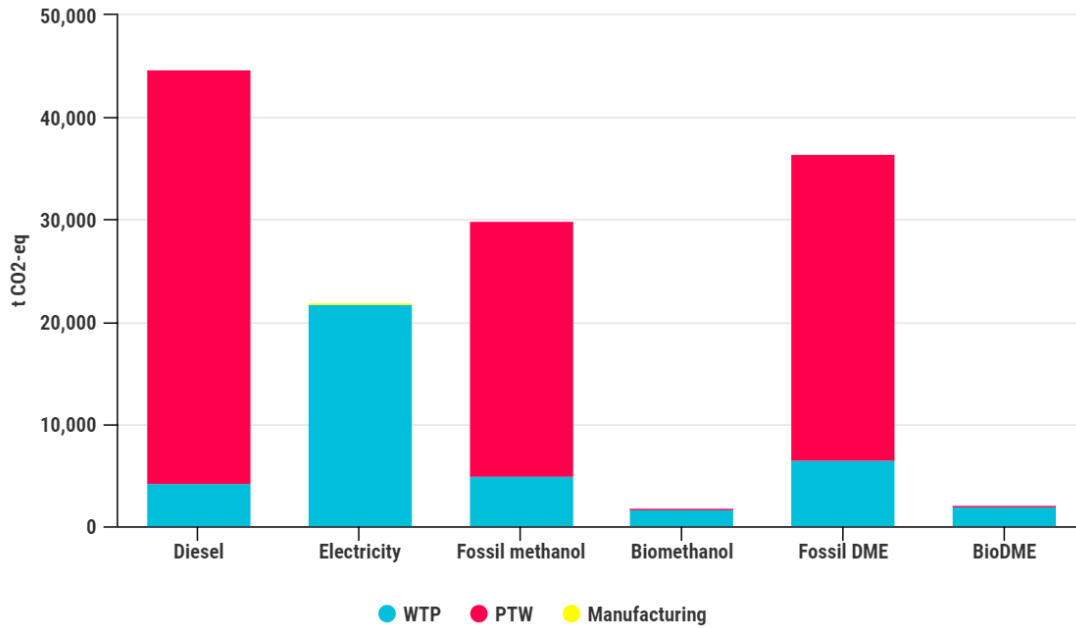

Figure 19 The comparative LCA of different power options implemented on Ship 2

The considered biofuels are fuels produced from forest residue. Besides methanol and DME, emissions associated with an electricity-powered ship and diesel-powered ship are presented in Figure 19, where it can be seen that both biomethanol and bioDME are more environmentally friendly than an electricity-powered ship. However, this is only valid when the tailpipe GHG emissions of biofuels are not taken into account. Nevertheless, biofuels have lower WTP emissions than fossil ones, and their use will lead to a reduced CF.

In this paper, the results of the LCCA analysis are related to the assumed ship lifetime of 20 years. Since the lifetime affects the total results, a sensitivity analysis was performed in which the ship lifetime is varied, i.e. lifetimes of 5, 10, 15 and 20 years are considered and the results are illustrated in Ship 2, Figure 20. The analysis has mostly affected carbon emission costs since they increase in time. Therefore, for a lifetime of 5 years, total life-cycle carbon emission costs for different power system configurations are, as can be expected, lower than for a lifetime of 10, 15 and 20 years. Given this, and given the higher investment cost, for a lifetime of 5 years, an electricity-powered ship has only 32% lower life-cycle costs than the diesel power system configuration, while for a lifetime of 20 years, this value amounts to 56%.

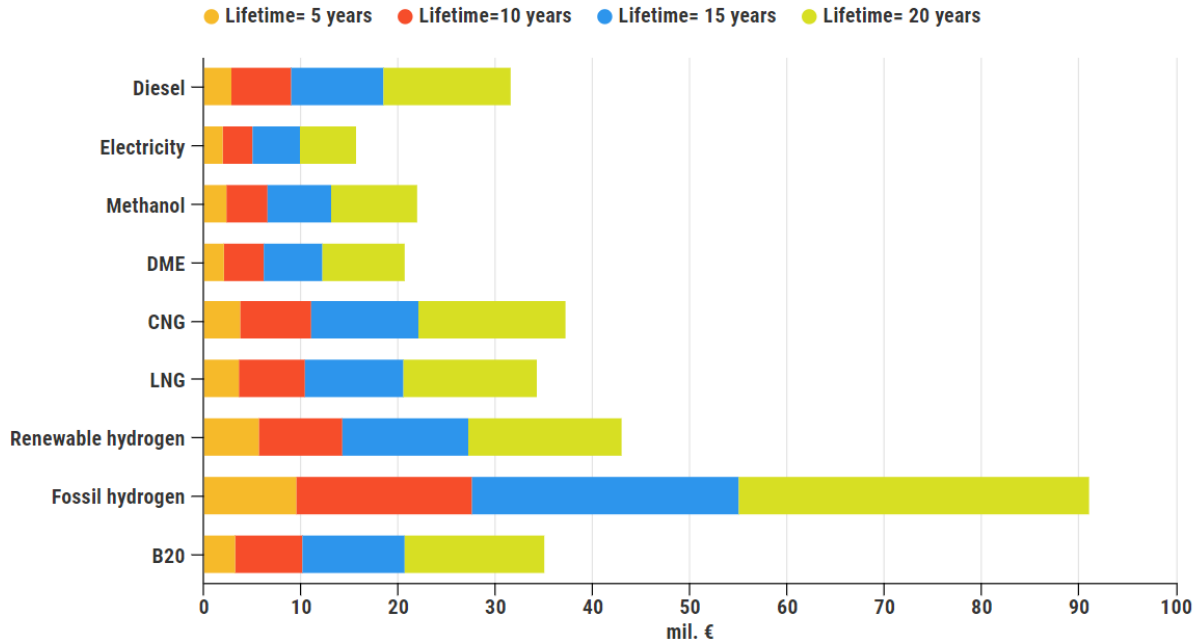

Figure 20 Sensitivity analysis

6. Conclusion

Environmental regulations are pushing the shipping industry to reduce its environmental impact related to GHG emissions, i.e. its CF. This reduction can be achieved by replacing conventional diesel fuel with cleaner marine fuels. Since implementation is location-specific and depends on technical performance, availability, investment costs and impact on the environment, alternative marine fuels that can be used in the Croatian short-sea shipping sector were investigated. Seven alternatives to existing diesel fuel options were analysed and the results are illustrated on three different Croatian ro-ro passenger ships. While the most ecological solution is established by the LCA, through the LCCA the most economical alternative option is highlighted. The LCA considers only GHG emissions associated with a power system and which are released during the ship lifetime. The main findings of this study can be summarized as follows:

- An electricity-powered ship, with only a Li-ion battery as the main power source, is indicated as the most environmentally friendly alternative. This power system configuration resulted in around 50% lower CO₂-eq emissions than the existing diesel-powered configuration. However, it should be noted that most of the emissions are released during the process of electricity generation and that the electricity mix used makes a major

contribution to the LCA emissions. In this paper, the Croatian electricity mix contains 46% of renewable energy sources.

- The most cost-effective option is also an electricity-powered ship with a payback period of about four years and around 56% lower total costs than a diesel-powered ship. This applies for all three considered vessels.
- The implementation of the carbon emission cost in the shipping sector could stimulate shipowners and ship operators to replace conventional fuel with alternatives, especially with an electricity-powered ship which would be even more attractive if the battery price falls in the future.
- Due to higher total costs and a higher CF in comparison to a diesel-powered ship, hydrogen production on board and its use in a fuel cell as the only energy source for ship operation is not environmentally friendly and is a rather expensive power system configuration. The main reason for this is the large battery and the great amount of electricity from the Croatian electricity mix needed for battery charging. If the ship uses RESs as an electricity power source, and a fuel cell system is used only as an auxiliary power system with other energy sources, renewable hydrogen on board will be more appealing, both from an environmental and economical point of view.

Besides the analysed ro-ro passenger fleet, in the Croatian shipping sector there are several other fleet types with irregular operating schedules (fishing vessels, inland waterway vessels, large merchant vessels, etc.) which produce great amounts of GHG emissions. Research on the reduction of the CF related to these ships either by the application of cleaner fuels or the implementation of RESs on board will be the subject of further investigation. Special attention will be paid not only to CO₂ emissions, but also to noxious gases.

Acknowledgement

This research was supported by the Croatian Science Foundation under the project Green Modular Passenger Vessel for Mediterranean (GRiMM), (Project No. UIP-2017-05-1253) as well as within the Croatian-Chinese bilateral project “Energy Efficient and Environmentally Friendly Power System Options for Inland Green Ships” between the University of Zagreb, Faculty of Mechanical Engineering and Naval Architecture (Croatia) and Wuhan University of Technology (China). Maja Perčić, a Ph.D. student, is supported through the “Young Researchers' Career Development Project – Training of Doctoral Students” of the Croatian Science Foundation, funded by the European Union from the European Social Fund.

In this paper, LCAs were performed by GREET 19 software produced by UChicago Argonne, LLC under Contract No. DE-AC02-06CH11357 with the Department of Energy.

Literature

- [1] United Nations Framework Convention Climate Change (UNFCCC). Climate Change Information kit, <https://unfccc.int/resource/iuckit/cckit2001en.pdf>; 2001 [accessed 09 February 2020].
- [2] Environmental Protection Agency (EPA). Understanding the Global Warming Potentials, <https://www.epa.gov/ghgemissions/understanding-global-warming-potentials>; 2020 [accessed 14 May 2020].
- [3] Odeh NA., Cockerill TT. Life cycle GHG assessment of fossil fuel power plants with carbon capture and storage. *Energy Policy* 2008; 36 (1): 367-380.
- [4] Monteiro A, Russo M, Gama C, Borrego C. How important are maritime emissions for the air quality: At European and national scale. *Environmental Pollution* 2018; 242: 565-575.
- [5] IMO. Third IMO GHG Study, Executive Summary and Final Report. <http://www.imo.org/en/OurWork/Environment/PollutionPrevention/AirPollution/Documents/Third%20Greenhouse%20Gas%20Study/GHG3%20Executive%20Summary%20and%20Report.pdf>; 2014 [accessed 18 March 2020].
- [6] Wiedmann T, Minx J. A Definition of Carbon Footprint. In: Pertsova CC. *Ecological Economics Research Trends*, Hauppauge NY: Nova Science Publishers; 2008, p. 1-11.
- [7] IMO. Marine Environment Protection Committee (72nd session), <http://www.imo.org/en/MediaCentre/MeetingSummaries/MEPC/Pages/Default.aspx>; 2018 [accessed 09 February 2020].
- [8] Bouman EA, Lindstad E, Rialland AI, Strømman AH. State-of-the-art technologies, measures, and potential for reducing GHG emissions from shipping – A review. *Transportation Research Part D: Transport and Environment* 2017; 52: 408-421.
- [9] Chen L, Yip TL, Mou J. Provision of Emission Control Area and the impact on shipping route choice and ship emissions. *Transportation Research Part D: Transport and Environment* 2018; 58: 280-291.
- [10] Ait Allal A, Mansouri K, Youssfi M, Qbadou M. Toward an evaluation of marine fuels for a clean and efficient autonomous ship propulsion energy. *Materials Today: Proceedings* 2019; 13: 486–495.
- [11] Livanos GA, Theotokatos G, Pagonis D-N. Techno-economic investigation of alternative propulsion plants for Ferries and RoRo ships. *Energy Conversion and Management* 2014; 79: 640–651.
- [12] Schinas O, Butler M, 2016. Feasibility and commercial considerations of LNG-fueled ships. *Ocean Engineering* 2016; 122: 84–96.
- [13] Sharafian A, Blomerus P, Mérida W. Natural gas as a ship fuel: Assessment of greenhouse gas and air pollutant reduction potential. *Energy Policy* 2019; 131: 332-346.
- [14] Jaharzadeh S, Paltrinieri N, Utne IB, Ellingsen H. LNG-fuelled fishing vessels: A systems engineering approach. *Transportation Research Part D* 2017; 20; 202-222.
- [15] Moirangthem K. *Alternative Fuels for Marine and Inland Waterways*. EU, JRC technical report; 2016. doi: 10.2790/227559.

- [16] IMO Methanol as marine fuel: Environmental benefits, technology readiness, and economic feasibility, <http://www.imo.org/fr/OurWork/Environment/PollutionPrevention/AirPollution/Documents/Report%20Methanol%202021.01.2016.pdf>; 2016 [accessed 22 May 2020].
- [17] Svanberg M, Ellis J, Lundgren J, Landälv I. Renewable methanol as a fuel for the shipping industry. *Renewable and Sustainable Energy Reviews* 2016; 94: 1217–1228.
- [18] Matzen M, Alhajji M, Demirel Y. Chemical storage of wind energy by renewable methanol production: Feasibility analysis using a multi-criteria decision matrix. *Energy* 2015; 93: 343-353.
- [19] Hammond GP, Seth SM. Carbon and environmental footprinting of global biofuel production. *Applied Energy* 2013; 112: 547-559. <https://doi.org/10.1016/j.apenergy.2013.01.009>.
- [20] Matzen M, Demirel Y. Methanol and dimethyl ether from renewable hydrogen and carbon dioxide: Alternative fuels production and life-cycle assessment. *Journal of Cleaner Production* 2016; 139:1068-1077.
- [21] Wang X, Demirel Y. Feasibility of Power and Methanol Production by an Entrained-Flow Coal Gasification System. *Energy & Fuels* 2018; 32: 7595-7610. <https://doi.org/10.1021/acs.energyfuels.7b03958>.
- [22] van Biert L, Godjevac M, Visser K, Aravind PV. A review of fuel cell systems for maritime applications. *Journal of Power Sources* 2016; 327: 345-364.
- [23] DNV GL-Maritime. Assessment of selected alternative fuels and technologies; 2018.
- [24] Brynolf S, Fridell E, Andersson K. Environmental assessment of marine fuels: liquefied natural gas, liquefied biogas, methanol and bio-methanol. *Journal of Cleaner Production* 2014; 74: 86-95.
- [25] Gilbert P, Walsh C, Traut M, Kesieme U, Pazouki K, Murphy. Assessment of full life-cycle air emissions of alternative shipping fuels. *Journal of Cleaner Production* 2018; 172: 855-866.
- [26] Deniz C, Zincir B. Environmental and economical assessment of alternative marine fuels. *Journal of Cleaner Production* 2016; 113: 438-449.
- [27] Fernández-Dacosta C, Shen L, Schakel W, Ramirez A, Kramer GJ. Potential and challenges of low-carbon energy options: Comparative assessment of alternative fuels for the transport sector. *Applied Energy* 2019; 236: 590–606.
- [28] Gagatsi E, Estrup T, Halatsis A. Exploring the potentials of electrical waterborne transport in Europe: the E-ferry concept. *Transportation Research Procedia* 2016; 14: 1571-1580.
- [29] Lindstad HE, Eskeland GS, Riialand A. Batteries in offshore support vessels - Pollution, climate impact and economics. *Transportation Research Part D: Transport and Environment* 2017; 50: 409-417.
- [30] Jadrolinija. Croatian ferries , <https://www.jadrolinija.hr/o-nama/brodovi/trajekti/trajekti-lokalnih-linija>; 2020 [accessed 26 May 2020].
- [31] Croatian Register of Shipping (CRS). Web report of a ship, <http://report.crs.hr/hrbwebreports/Default.aspx>; 2020 [accessed 26 May 2020].
- [32] Jadrolinija. Ferry lines schedule, <https://www.jadrolinija.hr/red-plovidbe/lokalne-linije-2020->; 2020 [accessed 26 May 2020].
- [33] Ančić I, Vladimir N, Cho DS. Determining environmental pollution from ships using Index of Energy Efficiency and Environmental Eligibility (I4E). *Marine Policy* 2018; 95: 1-7.

- [34] Life Cycle Standards. <https://www.pre-sustainability.com/legacy/download/Life-Cycle-Based-Sustainability-Standards-Guidelines.pdf>; 2020 [accessed 21 August 2020].
- [35] ISO 14040. <https://www.iso.org/standard/37456.html>; 2020 [accessed 21 August 2020].
- [36] ISO 14044. <https://www.iso.org/standard/38498.html>; 2020 [accessed 21 August 2020].
- [37] INA. Motor fuels, <https://www.ina.hr/en/home/customers/products-and-services/motor-fuels/>; 2020 [accessed 18 March 2020].
- [38] Croatian Energy Regulatory Agency (CERA). Annual Report, https://www.hera.hr/en/docs/HERA_Annual_Report_2018.pdf; 2018 [accessed 15 February 2020].
- [39] Jeong B, Wang H, Oguz E, Zhou P. An effective framework for life cycle and cost assessment for marine vessels aiming to select optimal propulsion systems. *Journal of Cleaner Production* 2018; 187: 111-130.
- [40] Zubi G, Dufó-López R, Carvalho M, Pasaoglu G. The lithium-ion battery: State of the art and future perspectives. *Renewable and Sustainable Energy Reviews* 2018; 89: 292-308.
- [41] Gandoman FH, Jaguemont J, Shovon Goutam S, Gopalakrishnan R, Firouz Y, Kalogiannis T, Omar N, Van Mierlo J. Concept of reliability and safety assessment of lithium-ion batteries in electric vehicles: Basics, progress, and challenges. *Applied Energy* 2019; 251: 113343.
- [42] HEP. Sources for Croatian electricity generation, <http://www.hep.hr/elektra/trziste-elektricne-energije/izvori-elektricne-energije/1553#>; 2020 [accessed 25 March 2020].
- [43] Ammar NR. An environmental and economic analysis of methanol fuel for a cellular container ship. *Transportation Research Part D* 2019; 69: 66–76.
- [44] MAN. The ME-LGI Engine and Methanol as a Marine Fuel, <https://marine.man-es.com/two-stroke/2-stroke-engines/me-lgim>; 2020 [accessed 05 May 2020].
- [45] MAN. Marine engine programme. https://www.man-es.com/docs/default-source/marine/4510_0017_02web.pdf?sfvrsn=4e9c62f7_12; 2019 [accessed 28 April 2020].
- [46] Methanex. <https://www.methanex.com/about-methanol>; 2020 [accessed 28 April 2020].
- [47] MAN B&W. ME-LGIP dual-fuel engines. https://www.man-es.com/docs/default-source/marine/5510-0210-00ppr-man-b-w-me-lgip-dual-fuel-engines-web.pdf?sfvrsn=eb5894b7_12; 2020 [accessed 25 August 2020].
- [48] Wan C, Yan X, Zhang D, Yang Z. A novel policy making aid model for the development of LNG fuelled ships. *Transportation Research Part A: Policy and Practice* 2019; 119: 29–44.
- [49] Kumar S, Kwon H, Choi K, Lim W, Cho JH, Tak K, Moon I. LNG: An eco-friendly cryogenic fuel for sustainable development. *Applied Energy* 2011; 88: 4264–4273.
- [50] Ammar NR and Seddiek IS. Eco-environmental analysis of ship emission control methods: Case study RO-RO cargo vessel. *Ocean Engineering* 2016; 137: 166–173.
- [51] Wärtsilä. Dual- fuel engines, <https://www.wartsila.com/encyclopedia/term/dual--fuel-engines-from-w%C3%A4rtsil%C3%A4>; 2020 [accessed 18 May 2020].
- [52] Wärtsilä. 34DF, product guide, https://www.wartsila.com/docs/default-source/product-files/engines/df-engine/product-guide-o-e-w34df.pdf?utm_source=engines&utm_medium=dfengines&utm_term=w34df&utm_content=productguide&utm_campaign=msleadscoring; 2019 [accessed 06 May 2020].
- [53] Ekanem Attah E, Bucknall R. An analysis of the energy efficiency of LNG ships powering options using the EEDI. *Ocean Engineering* 2015; 110: 62-74.
- [54] European Commission. Report on European gas markets, https://ec.europa.eu/energy/sites/ener/files/documents/quarterly_report_on_european_gas_markets_q2_2019_final_v1.pdf; 2019 [accessed 07 May 2020].

- [55] Bicer Y, Dincer I. Clean fuel options with hydrogen for sea transportation: A life cycle approach. *International Journal of Hydrogen Energy* 2017; 43: 1179-1193.
- [56] Timmerberg S, Kaltschmitt M, Finkbeiner M. Hydrogen and hydrogen-derived fuels through methane decomposition of natural gas – GHG emissions and costs. *Energy Conversion and Management: X* 2020. doi: <https://doi.org/10.1016/j.ecmx.2020.100043>.
- [57] Inal BO, and Deniz C. Assessment of fuel cell types for ships: Based on multi-criteria decision analysis. *Journal of Cleaner Production* 2020; 265: 121734.
- [58] Ghenai C, Bettayeb M, Brdjanin B, Hamid AK. Hybrid solar PV/PEM fuel Cell/Diesel Generator power system for cruise ship: A case study in Stockholm, Sweden. *Case Studies in Thermal Engineering* 2019; 14: 100497.
- [59] Rivarolo M, Rattazi D, Lamberti T, Magistri L. Clean energy production by PEM fuel cells on tourist ships: A time-dependent analysis. *International Journal of Hydrogen Energy* 2020. <https://doi.org/10.1016/j.ijhydene.2019.12.086>.
- [60] Matute G, Yusta JM, Correas LC. Techno-economic modelling of water electrolyzers in the range of several MW to provide grid services while generating hydrogen for different applications: A case study in Spain applied to mobility with FCEVs. *International Journal of Hydrogen Energy* 2019; 44 (33): 17431-17442.
- [61] Bareiß K, de la Rua C, Möckl M, Hamacher, T. Life cycle assessment of hydrogen from proton exchange membrane water electrolysis in future energy systems. *Applied Energy* 2019; 237: 862–872.
- [62] Garraín D, Lechón Y. Exploratory environmental impact assessment of the manufacturing and disposal stages of a new PEM fuel cell. *International Journal of Hydrogen Energy* 2014; 39 (4): 1769-1774.
- [63] Demirbas A. Progress and recent trends in biodiesel fuels. *Energy Conversion and Management* 2009; 50 (1): 14-34.
- [64] Mohd Noor CW, Noor MM, Mamat R. Biodiesel as alternative fuel for marine diesel engine applications: A review. *Renewable and Sustainable Energy Reviews* 2018; 94: 127–142.
- [65] Buratti C, Barbanera M, Fantozzi F. A comparison of the European renewable energy directive default emission values with actual values from operating biodiesel facilities for sunflower, rape and soya oil seeds in Italy. *Biomass and Bioenergy* 2012; 47: 26-36.
- [66] EU Emissions Trading System. https://ec.europa.eu/clima/policies/ets_en; 2020 [accessed 18 May 2020].
- [67] Trivyza NL, Rentizelas A, Theotokatos G. Impact of carbon pricing on the cruise ship energy systems optimal configuration. *Energy* 2019; 175: 952-966.
- [68] International Energy Agency. *World Energy Outlook 2019*. <https://doi.org/10.1787/caf32f3b-en>.
- [69] European Commission. *Energy prices and costs in Europe, Annex 3*, https://ec.europa.eu/energy/sites/ener/files/documents/annex_3_-_country_sheets_-_part_4_of_4_post_isc-v2.pdf; 2018 [accessed 25 April 2020].
- [70] Iannaccone T, Landucci G, Tugnoli A, Salzano E, Cozzani V. Sustainability of cruise ship fuel systems: Comparison among LNG and diesel technologies. *Journal of Cleaner Production* 2020; 260: 121069.
- [71] Christos B. Techno-economical feasibility study on the retrofit of double-ended Ro/Pax ferries into battery-powered ones. Diploma thesis. National Technical University of Athens, School of Naval Architecture and Marine Engineering; 2017.
- [72] Tsiropoulos I, Tarvydas D, Lebedeva N. Li-ion batteries for mobility and stationary storage applications. *JCR Science for Policy Report*, <http://publications.jrc.ec.europa.eu/repository/bitstream/JRC113360/kjna29440enn.pdf>; 2018 [accessed 26 April 2020].

- [73] Ellis J, Tanneberger K. Study on the use of ethyl and methyl alcohol as alternative fuels in shipping. Report prepared for the European Maritime Safety Agency (EMSA); 2015.
- [74] CNG Europe. Price by countries, <http://cngeurope.com/>; 2020 [accessed 05 May 2020].
- [75] European Commission. Fuel price comparison, <https://ec.europa.eu/transport/sites/transport/files/2017-01-fuel-price-comparison.pdf>; 2017 [accessed 31 May 2020].
- [76] California Dimethyl Ether Multimedia Evaluation, https://ww3.arb.ca.gov/fuels/multimedia/meetings/dmetierireport_feb2015.pdf; 2015 [accessed 25 August 2020].

ARTICLE 4

Preprint of the published journal article.

Electrification of inland waterway ships considering power system lifetime emissions and costs

Maja Perčić ¹, Nikola Vladimir ^{1, *}, Marija Koričan ¹

¹ University of Zagreb, Faculty of Mechanical Engineering and Naval Architecture, Zagreb, Croatia, maja.percic@fsb.hr; nikola.vladimir@fsb.hr; marija.korican@fsb.hr

* Correspondence: nikola.vladimir@fsb.hr

Abstract: This paper deals with the applicability of alternative power system configurations to reduce the environmental footprint of inland waterway ships. Its original contribution includes: models for assessment of the lifetime emissions and associated lifetime costs of alternative power system configurations for different types of inland waterway vessels, identification of the most cost-effective options for these vessels and an estimation of the impact of emission policies on the profitability of each option. The case study considers Croatian inland waterway sector, where three types of vessel with significantly different purposes, designs and operative profiles are considered (cargo ship, passenger ship and dredger). The technical and operational features of these ships are analyzed with an emphasis on their energy needs. Then, Life-Cycle Assessments (LCAs) of a diesel-engine-powered ship configuration and two battery-powered ship configurations (with and without a photovoltaic system) are performed by means of GREET 2020 software. These configurations are compared from the economical viewpoint, by the Life-Cycle Cost Assessment (LCCA), where potential carbon credit scenarios are investigated, while relevant quantities are converted into monetary units. Although the LCA identified the photovoltaic cells battery-powered ship configuration as the most environmentally friendly, according to the LCCA its life-cycle costs are rather high, except for passenger ships, for which the battery-powered ship configuration is a feasible option. If a set of required specific input data is known, the presented procedure is applicable to reduce environmental footprint of any other inland waterway fleet.

Citation: Lastname, F.; Lastname, F.; Lastname, F. Title. *Energies* **2021**, *14*, x. <https://doi.org/10.3390/xxxxx>

Academic Editor: Firstname Lastname

Received: date
Accepted: date
Published: date

Publisher's Note: MDPI stays neutral with regard to jurisdictional claims in published maps and institutional affiliations.



Copyright: © 2021 by the authors. Submitted for possible open access publication under the terms and conditions of the Creative Commons Attribution (CC BY) license (<https://creativecommons.org/licenses/by/4.0/>).

Keywords: inland waterway transport; LCA; LCCA; emissions; carbon allowance; ship power system

1. Introduction

Inland navigation is, together with road and rail transport, one of the three mainland transport modes and can be considered as the most cost-effective and safest mode of transport [1]. Freight and passengers are transported by vessels via inland waterways, such as canals, rivers and lakes, between inland ports and wharfs [2]. Design requirements for inland waterway vessels and seagoing vessels are fundamentally different, and therefore inland waterway vessels are generally not allowed to navigate at sea, [3]. Xing et al. [4] have compared the operational energy efficiency of inland waterway vessels with seagoing vessels and concluded that the presence of a river current leads to the reduction of energy efficiency for vessels engaged in inland waterway transportation.

Research into emissions from shipping and their impact on air quality has mainly been directed to seagoing vessels, such as in the studies by Ančić et al. [5], Lindstad et al. [6], Miola and Ciuffo [7], Ammar and Seddiek [8], Chen et al. [9], and has focused less on inland waterway vessels. However, it is important to mention that inland navigation

regularly takes place within highly populated areas, and its effect is therefore even more pronounced [10], [11]. This particularly refers to emissions which have a strongly local character, although carbon dioxide (CO₂) emissions should not be ignored either.

The exhaust gases produced by the combustion of fuel oil in marine engines contain different harmful substances, such as sulphur oxides (SO_x), nitrogen oxides (NO_x), carbon monoxide (CO), particulate matter (PM), as well Greenhouse Gas (GHG) emissions, which particularly refer to the emissions of CO₂, methane (CH₄) and nitrous oxide (N₂O). In order to control these emissions, the International Maritime Organization (IMO) has set different standards related to Energy Efficiency Design Index (EEDI) and Ship Energy Efficiency Management Plan (SEEMP) [12]. Furthermore, by establishing several Emission Control Areas (ECA), IMO has ensured emission control in specific areas where emission requirements are stricter than outside these areas [13]. SO_x emission control is performed with the limitation of sulphur content in fuel, while NO_x emissions are limited depending on the engine maximum operating speed. Both the SO_x and NO_x regulation standards differ depending on the navigation area (global or ECA) [14]. Besides their environmental impact, exhaust gases negatively affect human health [15]. This is more pronounced when ships spend more time in ports and near inhabited areas [16], which is typical for ships engaged in short-sea shipping and inland navigation.

The most attractive research topic in the field of shipping emissions is decarbonization, i.e. reduction of GHG emissions. Generally, decarbonization of the shipping industry can be achieved by increasing ship energy efficiency leading to a reduction in fuel oil consumption and ultimately to a reduction in GHG emissions [17]. Bouman et al. [18] discussed technical and operational decarbonization measures that can be implemented in the shipping sector. Since most of the measures are based on the reduction of fuel consumption, besides GHGs, other emissions (NO_x, SO_x, PM etc.) are reduced as well. Among different operational measures, the voluntary speed reduction represents the most effective operational measure for CO₂ reduction, as investigated by Corbett et al. [19] and Lindstad et al. [20]. Furthermore, the most promising technical measure to reduce the negative effects of shipping emissions includes replacing conventional marine fuel oil with alternative fuels (such as biodiesel, hydrogen, electricity, natural gas, methanol, dimethyl ether, ammonia, etc.) like indicated in the study of Perčić et al. [21] and replacing the conventional propulsion system (a diesel-engine-powered ship) with a Hybrid Propulsion System (HPS) or an Integrated Propulsion System (IPS) [22]. Psaraftis et al. [23] investigated inclusion of carbon allowance policy in the shipping sector as a market-based measure that could lead to decarbonization, where the CO₂ cost impact would represent an incentive to implement technical or operational measures that results in lower CO₂, preferably zero-carbon emission solution, such as full electrification of ships. Such a kind of ferry has been presented by Gagatsi et al. [24]. The great advantage of such vessels is that they do not release exhaust gases during navigation, although they do have some limitations regarding battery capacity, power source degradation, price, weight and charging, as well as sailing distance [25]. A comprehensive review of promising technologies and practices that are applicable to onboard energy systems of all-electric ships including the sensitivity analysis of energy efficiency of all-electric ships with respect to different applications is recently done by Nuchtaree et al. [26].

The implementation of renewable power sources onboard leads to a reduction of emitted GHGs, as indicated in many studies. Geertsma et al. [27] presented a review of developments in the field of design and control of HPSs for smart ships analyzing their trends, challenges and opportunities and finally claiming that a combination of torque, angle of attack, and relevant control strategy could improve their fuel consumption and consequently environmental footprint. In the design and operation of ships with HPS optimal sizing of power generation units plays a key role, where regularly minimum investment and operating costs are set as objectives [28], but most often expenses related to emission allowance are not taken into account. Ghenai et al. [29] presented an HPS for a cruise ship, where the total power is generated by photovoltaic (PV) cells, fuel cells and a

diesel generator which also resulted in reduced emissions. The inclusion of a battery system for a diesel mechanical short sea ship was investigated by Ritari et al. [30], claiming that the battery system can result in significant fuel savings, which become more important with the increase in fuel price. By investigating a PV cell diesel-engine-powered ship, Yuan et al. [31] showed that its operation leads to a reduction in both diesel consumption and GHG emissions. Wu et al. studied cost-effective energy management strategies considering hybrid fuel cell and battery propulsion systems for coastal ships, providing a novel so-called reinforcement learning approach for their optimal use [32]. Energy management itself represents an important research topic for both hybrid and all-electric vessels, as can be seen in [32] and [33]. HPSs are presented for different ship types differing in their purposes and operative performances, as for instance tankers [28], cruise ships [29], passenger ferries [32], offshore platform supply vessels [34], etc., but in most cases, investment costs represent a key issue in their wider application. However, Life-Cycle Assessment (LCA) of a new-build HPS for ro-ro cargo ship performed by Ling-Chin and Roskilly, [35], by means of GaBi software, resulted in its rather high impact on the environment, human beings and natural reserves. Furthermore, as reported by Lindstad et al. [36], a combination of battery and internal combustion engines on an existing ship resulted in reduced emissions, but the main obstacle for this retrofit was the price of the battery. One way to evaluate the profitability of a retrofit is to consider the total Life-Cycle Costs (LCCs) by performing a Life-Cycle Cost Assessment (LCCA). Wang et al. [37] investigated the implementation of a solar panel array onboard a ferry where the LCCA results showed that the investment payback period is only three years, which makes a solar panel array not only an environmentally friendly technology but also an economical one. It is necessary to mention that these findings are generally applicable, but strongly dependent on a set of assumptions and considered operative conditions.

Based on the above extensive literature review, an evident literature gap can be seen. Even though the utilization of renewable energy sources onboard shows a reduction in shipping emissions, none of these studies was oriented towards inland waterway vessels. Due to many special features inherent in inland waterway transport, the results of the above-mentioned studies cannot be directly used, especially regarding cost assessments. So, it is not clear which option would have the lowest environmental impact and would be the most profitable for inland waterway vessels. Moreover, the operation of inland waterway vessels is highly dependent on the location, since waterway conditions regularly differ greatly from one area to another, and the application of relevant measures to improve ship energy efficiency should be assessed on a case-by-case basis. Therefore, the aim of this paper is to set a model for investigation of the applicability of different power system configurations both from the environmental and economic point of view for the retrofit of three different vessel types. The procedure is illustrated for the Croatian inland waterway fleet which is rather aged and requires a significant increase in its energy efficiency and reductions in fuel oil consumption to meet emerging environmental requirements. However, it is applicable to any other inland waterway sector, if a set of input data is known. It should be mentioned that the bounds of the analysis are set at the single ship level, while this paper did not address the cooperation and optimal operation of onboard energy systems and on-land shore power. This should be considered further in order to obtain cost savings from the perspective of shipping company, where approaches from [38] and [39] could be adopted.

The original contribution of this study is summarized as follows: (a) the development of models to assess the GHG, NO_x, SO_x and PM10 emissions of different power system configurations for three inland waterway vessels; (b) the identification of the most cost-effective powering option for the observed ships; (c) an estimation of the policy impact on the profitability of each option. In order to achieve a fair comparison between different power system configurations an approach by Jeong et al. [40] is adopted, where all incomparable values are converted into monetary values, and proper solution is selected in a straightforward manner.

This paper is structured into six sections. In the next section, the methodology is described. A model for alternative power configuration selection that takes into account life-time emissions and costs is elaborated. The LCA and LCCA procedures are described in detail. The third section is dedicated to the analysis of the Croatian inland waterway fleet, with the aim to identify typical vessels according to their purpose and operative profile and to calculate their energy needs as a prerogative for LCA and LCCA. The results are listed in the fourth section, while a discussion of the procedure and the obtained results are presented in the fifth section. Finally, concluding remarks are drawn in the sixth section.

2. Methodology

In order to evaluate the environmental impact and conclude which power system is the most suitable for implementation, LCAs of different power system configurations oriented to ship electrification are performed.

The flowchart of the procedure is presented in Figure 1. The first step is fleet analysis, which includes gathering information about ship types, their purposes, operative profiles, their power systems, etc. Based on the ship purposes and their operative profiles, representatives are selected. Then, the ship power needs are calculated, enabling the definition of alternative power system configurations. In the next step, the emissions of an existing power system configuration as the referent one, as well as of the alternative ones, is evaluated through a set of LCAs [41]. Also, the lifetime economic performance of different power system configurations is evaluated by LCCAs.

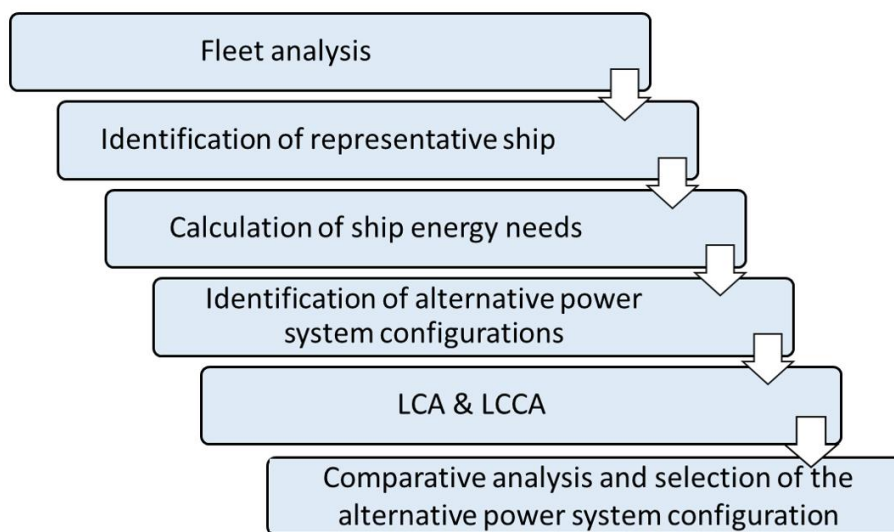

Figure 1. Procedure for selection of alternative power systems configuration for inland waterway vessels.

After performing LCAs and LCCAs, the comparative analysis between different power system configurations can be done and viable environmentally friendly options can be selected.

2.1. Calculation of ship energy needs

The inland waterway fleet is affected by the unidirectional currents and the geographical characteristics of the inland waterways [4]. Depending on the type of waterway, the fleet usually consists of river vessels, vessels that operate on lakes and stationary vessels. All these types of vessels require a specific approach in defining their energy needs. To calculate the average ship power, P_{ave} (kW), the main engine power, $P_{ME,ave}$ (kW), and the auxiliary engine power, $P_{AE,ave}$ (kW), are summed:

$$P_{ave} = P_{ME,ave} + P_{AE,ave}. \quad (1)$$

By dividing the P_{ave} with the average ship speed, v (km/h), the ship energy consumption per distance travelled, EC (kWh/km), can be calculated:

$$EC = \frac{P_{ave}}{v}. \quad (2)$$

From the calculated energy consumption, the annual energy consumption can be determined. The calculation is influenced by the exploitation characteristics of the fleet, i.e. the type of the representative ship. The exact equations are given in the next subsections.

The fuel oil consumption, FOC , is calculated by multiplying the energy consumption with the specific fuel oil consumption, $SFOC$, which is determined depending on the engine speed. As proposed by Ančić et al. [42], for high-speed engines the $SFOC$ is assumed to be 215 g/kWh. The FOC per distance travelled can be calculated as follows:

$$FOC = EC \cdot SFOC. \quad (3)$$

2.1.1. Energy needs of river vessels

The ship speed depends on several factors, such as the draught, environmental conditions, river speed and the direction of navigation (upstream and downstream). Taking into account the exploitation characteristics of a river ship, the energy consumption eq. (2) can be modified:

$$EC_{up} = \frac{P_{ave}}{v_{up}},$$

$$EC_{down} = \frac{P_{ave}}{v_{down}}, \quad (4)$$

where EC_{up} (kWh/km) denotes the energy consumption for the ship sailing upstream and EC_{down} (kWh/km) for the ship sailing downstream. The annual energy consumption $EC_{A,river}$ in kWh can be calculated according to:

$$EC_{A,river} = (EC_{up} + EC_{down}) \cdot L_{OT} \cdot N_{RT}, \quad (5)$$

where L_{OT} (km) denotes the length of a one-way trip, and N_{RT} denotes the annual number of return trips.

The fuel oil consumption both for the upstream, FOC_{up} , (kg/km), and for the downstream, FOC_{down} (kg/km), journey of the ship is calculated with the following equations:

$$FOC_{up} = EC_{up} \cdot SFOC,$$

$$FOC_{down} = EC_{down} \cdot SFOC. \quad (6)$$

If the ship operates on lakes, or the river current is negligible, the power for both upstream and downstream sailing is considered to be equal, and the annual energy consumption in kWh equals:

$$EC_{A,lake} = EC \cdot L_{RT} \cdot N_{RT}, \quad (7)$$

where L_{RT} (km) denotes the length of the return trip.

2.1.2. Energy demands of stationary units

The stationary unit performs a particular task, so it does not have a specific navigation route since most of the time is located at the same position. Consequently, it is not possible to calculate the energy consumption in kWh/km for this ship according to eq. (2).

Hence, a modified approach is required. By assuming the average load of the ship power, it is possible to approximately determine the time that the vessel spends in operation annually, $t_{A,stat}$ (h), by the following equation:

$$t_{A,stat} = \frac{FOC_{A,stat} \cdot \rho}{P_{ave,stat} \cdot SFOC}, \quad (8)$$

where $FOC_{A,stat}$ denotes the annual fuel oil consumption of the vessel in l, ρ denotes the fuel oil density in kg/l and $P_{ave,stat}$ denotes the average power onboard the vessel in kW. The annual energy consumption of the vessel, $EC_{A,stat}$, in kWh can then be calculated as follows:

$$EC_{A,stat} = P_{ave,stat} \cdot t_{A,stat}. \quad (9)$$

2.2. LCA

2.2.1. General

Increased awareness of the importance of environmental protection and the greenhouse effect has led to the development of a method for the assessment of the environmental impact of a product through the emissions that are associated with it. This method is known as LCA. According to the International Organization for Standardization [43], LCA investigates the product's influence on the environment throughout its life-cycle, which includes:

- Raw material recovery;
- Production or manufacturing;
- Use of the product;
- End of life treatment;
- Recycling and final disposal.

In this paper, LCAs are performed by means of GREET 2020 software [44] The used tool offers two options in setting the analysis boundaries: observing the processes of raw material recovery, the production of the power source, and its supply to the ship, i.e. "Well-to-Pump" (WTP), or observing the processes of WTP plus the use of power sources in the ship operation ("Pump-to-Wake" (PTW)), i.e. "Well-to-Wake" (WTW). The WTW emissions and emissions released during the manufacturing process of the power system configuration represent the total environmental footprint of that configuration. In addition to WTP and PTW emissions, emissions released from the manufacturing processes of a major element in the power system configuration are also considered, i.e. the manufacturing process of battery/diesel-engine/PV cells materials. The GREET 2020 software is used to calculate emissions released during these processes based on its database, while the inputs are the weights of different materials that constitute a major element of the power system configuration. Since the LCA considers emissions during the life-cycle, all materials that are taken into account are analyzed according to the ship lifetime mileage, which is other input data for an analysis of the manufacturing processes. It should be noted that there are different life-cycle tools with their own sets of databases, but at this level of analysis, the GREET software can be reliably used for relatively simple pathways, as indicated in the recent [45], [46], [47] and [48].

As mentioned above, this paper considers electrification of inland waterway ship power systems as an alternative to widespread diesel-engine-powered options, with the aim to reduce lifetime emissions and costs. Therefore, in the next subchapters, LCAs and LCCAs of such power system configurations are explained.

2.2.2. LCA of diesel-engine-powered ships

In order to assess the lifetime emissions of diesel-engine-powered ships (as the referent case), the processes of diesel engine manufacturing, crude oil recovery and its

transportation to the refinery, diesel refining, distribution and the combustion of diesel in the engine need to be considered, Figure 2. The environmental impact of diesel engines was assessed by observing the manufacturing process and calculating the weights of the engine materials.

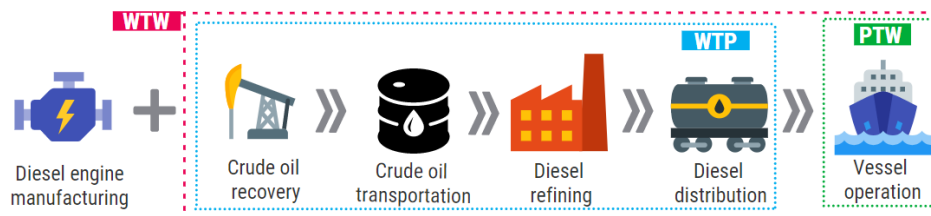

Figure 2. The life-cycle of the diesel-engine-powered ship configuration.

WTP emissions in this case refer to fuel oil production and distribution. By knowing the type of fuel the fleet uses, the parameters are obtained and the process of diesel refining and the process of crude oil recovery can be described.

Tailpipe emissions (*TE*), i.e. PTW emissions, refer to emissions released due to the combustion of diesel in the ship's engines. These emissions are calculated by multiplying the ship's fuel oil consumption with the emission factor, by the following equation:

$$TE = FOC \cdot EF, \quad (10)$$

where *EF* denotes the emission factor in kg gas/kg fuel and they are obtained from [49] To evaluate the contribution to the greenhouse effect from different GHGs, the Global Warming Potential (GWP) has been developed. It represents a measure of how much energy the emission of one ton of a gas will absorb over a given period, relative to the emission of one ton of CO₂. The time range usually used is 100 years and, typically, GHGs are reported in CO₂-eq [50].

2.2.3. LCA of battery-powered ships

The power system configuration that was considered as an option for retrofitting the diesel-engine-powered ships is the battery-powered ship configuration. Essentially, instead of a diesel engine, a Lithium-ion (Li-ion) battery is installed onboard and used to supply the power required for ship operation. Even though a Li-ion battery is quite expensive, it has by far the highest energy density compared to other types of batteries [51], and it is most prominent in shipping applications. When observing the life-cycle of a battery-powered ship, with the WTP of electricity, the process of battery manufacturing is also considered as a source of lifetime emissions, Figure 3.

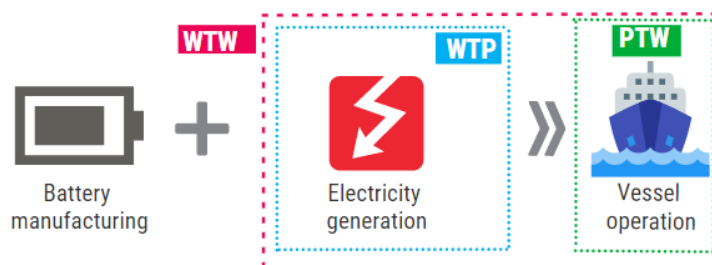

Figure 3. The life-cycle of the battery-powered ship configuration.

A battery-powered ship is supplied with power by the battery only, and during its operation, it does not release exhaust gases. Hence, it has zero PTW emissions. It is assumed that the ship is powered by an electric motor and that the power needs (of the existing, diesel-engine-powered ship) remain unchanged. Due to losses in the energy

conversion of the battery-powered ship configuration, the required power supplied by the battery should be divided by the coefficient of efficiency, η_{BAT} , which equals 0.91. Therefore, the average power output of the battery $P_{BAT,ave}$ yields:

$$P_{BAT,ave} = \frac{P_{ave}}{\eta_{BAT}}. \quad (11)$$

Annual energy consumption calculated for the diesel-powered ship according to eq. (2), eq. (4) and eq. (9) should also be divided by the coefficient of efficiency in order to determine the energy consumption for battery-powered ships EC_{BAT} .

$$EC_{BAT,A} = \frac{EC_A}{\eta_{BAT}}. \quad (12)$$

Battery capacity, BC (kWh), depends on the route the ship is sailing, i.e. the possibilities to plug in to charge the battery. For safety reasons, the required capacities are increased, and the increase is set at 25%. Depending on the type of the ship, the following set of equations can be derived:

$$\begin{aligned} BC &= 1.25 \cdot EC_{BAT} \cdot L, \\ BC &= 1.25 \cdot EC_{BAT} \cdot t_{DAY}, \end{aligned} \quad (13)$$

where L denotes the length of a one-way or the length of the return trip in km, and t_{DAY} denotes the number of operating hours in a day. Commercial Li-ion battery technology has limits regarding maximum power density [52]. With an assumed power density, the weights of batteries were calculated. The battery manufacturing process parameters are obtained from the GREET 2020 database.

The WTP of electricity refers to the process of electricity generation. The process is significantly affected by the price of electricity, which is directly related to the shares of electricity generation sources.

2.2.4. LCA of PV cells battery-powered ships

The second power system configuration considered for retrofitting the diesel-engine-powered vessels is the PV system implemented on board with a battery power system configuration (PV cells battery-powered ship). A PV system is made of PV modules, which consist of many individual interconnected PV cells. Their main advantage is the direct transformation of solar power into electric power, but their efficiency is low. Another limitation is the installation area on board. Usually, the PV cells are placed on the top deck in order not to disturb the passengers, the crew and the ship operations. Therefore, the ship's dimensions limit the installation area. Since the PV system is implemented onboard, the off-grid system needs a rechargeable battery, which can be used when there is little or no output from the PV system, for example on a cloudy day or at night [53]. The LCA of a PV cells battery-powered ship considers the WTP emissions of electricity and emissions released from the processes of Li-ion battery and PV module manufacturing. Like the previous option, this one also has zero PTW emissions, Figure 4.

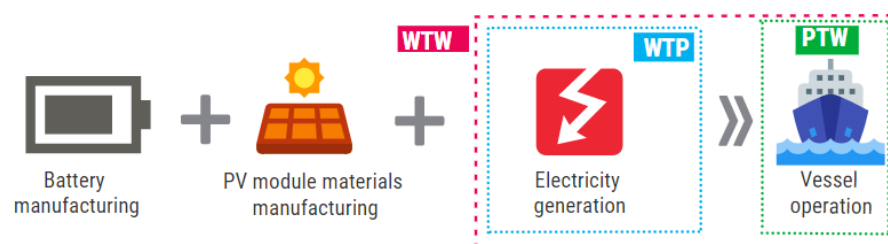

Figure 4. The life-cycle of the PV cells battery-powered ship configuration

311
312
313
314315
316
317
318319
320
321
322
323324
325
326
327
328329
330
331
332

333

334
335
336
337
338
339
340
341
342
343
344
345
346
347348
349

The utilization of solar energy depends on the area of navigation and its average annual solar irradiance. Since the ship sails in different directions, it is not possible to align the PV cells directly to the sun. Therefore, they are placed horizontally. It is fair to say that there are more advanced models to consider PV source output in marine environment like the one in [54] that takes into account the effect of a ship moving and rocking, but for inland waterway applications such considerations are not necessary. Therefore, the total annual electric energy produced, $E_{PV,A}$, by the PV system can be calculated according to the equation:

$$E_{PV,A} = \eta_{PV} \cdot E_{rad} \cdot A_{PV}, \quad (14)$$

where η_{PV} denotes the PV system efficiency, E_{rad} denotes the average annual solar irradiance in kJ/m^2 , while A_{PV} refers to the available installation area for PV cells on board in m^2 . Since PV cells in a PV cells battery-powered ship generate part of the electric power required for ship propulsion, its WTP emissions are lower than for the battery-powered ship. The energy consumption of this option EC_{PV-BAT} is reduced and equals:

$$EC_{PV-BAT,A} = 1.1 \cdot EC_A - E_{PV,A} \cdot \quad (15)$$

2.3. LCCA

2.3.1. General

The total costs of a ship power system configuration include investment costs and exploitation costs, Figure 5. The investment costs refer to the cost of retrofitting a ship. The maintenance cost, power source cost and carbon credit cost are incorporated in the exploitation costs. Costs of replacements during the ship lifetime (particularly battery replacement) are considered as part of the maintenance costs.

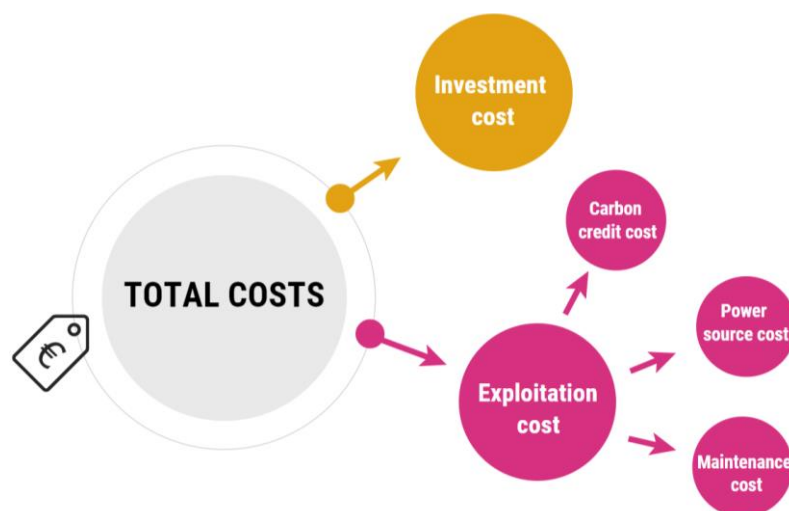

Figure 5. Total costs of a ship power system configuration.

Carbon credit, i.e. carbon pricing, can play an important role in providing an economically efficient incentive to reduce GHGs [55], [56]. Even though it is not implemented yet in the shipping industry, some sectors have already done so (industry, aviation, the electric power sector). Carbon credit refers to emission allowances which can be received or bought and even traded. Each allowance gives the right to emit 1 ton of CO_2 , the main GHG, or the equivalent amount of two more powerful GHGs, N_2O and perfluorocarbons (PFCs) [57]. It is necessary to observe different carbon credit scenarios which could potentially be implemented in the shipping sector. A study on this was conducted by Trivyza et

al. [58] for a cruise ship power system. Four scenarios were considered which include the non-taxation scenario (NT) and three carbon credit scenarios. Three scenarios, CP (Current Policies), NP (New Policies) and SD (Sustainable Development), were obtained from the World Energy Outlook 2018 [59], in which forecasted carbon allowance (CA) values for the years 2025 and 2040 are presented. These values refer to industry, aviation and the electric power sectors in the European Union, and they are presented in Figure 6. For 2020, the CA value is zero, since carbon credit was not yet implemented in the shipping industry. The scenarios considered in this paper are:

- NT scenario: carbon credit is not implemented;
- CP scenario: which considers the current policies that are implemented in the energy sector;
- NP scenario: which includes the current policies and incorporates the ambitions of the policy makers in the energy sector;
- SD scenario: which follows the 2030 agenda of the United Nations for Sustainable Development.

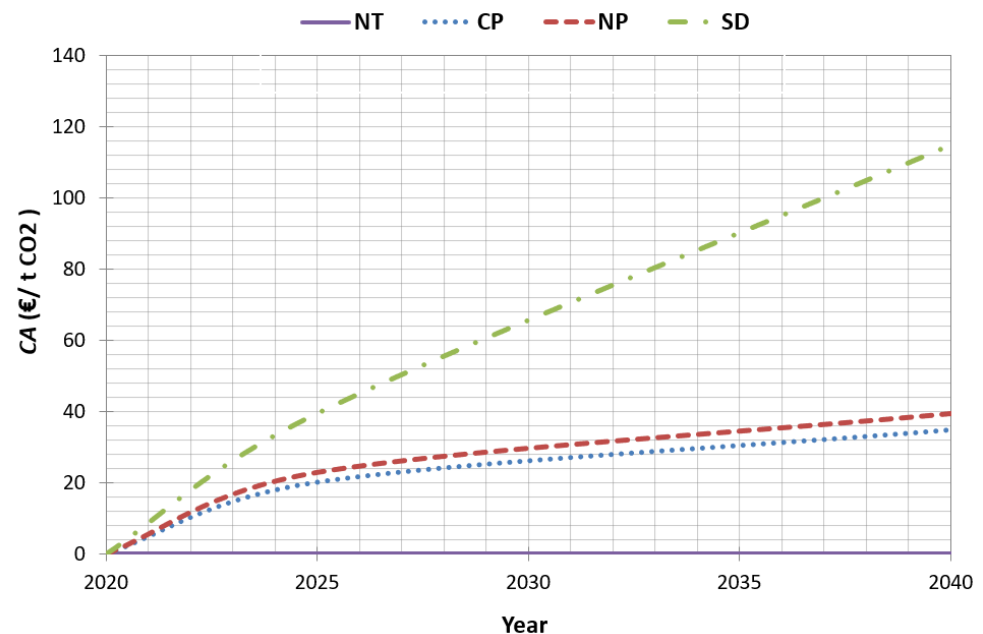

Figure 6. Carbon allowance scenarios.

Since carbon credit refers to permission to emit GHGs during ship operation, these scenarios are illustrated only on diesel-engine-powered inland waterway vessels. In this paper, carbon credit refers to emissions expressed in CO₂-eq.

2.3.2. LCCA of diesel-engine-powered ships

As described in the previous section, the total costs of different power system configurations consist of the investment and exploitation costs. A major part of the investment cost in retrofitting a ship with a new diesel engine is the procurement and installation of the engine. Another part of the total cost is the annual maintenance cost.

Considering the operational characteristics of each ship, the annual fuel oil consumption cost (FOCCA) in € can be calculated. For the river and lake vessels, the following relation can be established:

$$FOCCA = \frac{FOC \cdot L_{RT} \cdot N_{RT,A} \cdot DP}{\rho}, \quad (16)$$

where DP refers to the price of diesel. To calculate the annual fuel oil consumption cost of a stationary vessel, eq. (16) should be modified into:

$$FOCC_{A,stat} = \frac{FOC_{A,stat} \cdot DP}{\rho} \quad (17)$$

Carbon credit cost (CCC) values in € are calculated taking into account different carbon pricing scenarios according to:

$$CCC = \sum_{i=1}^t TE_{A,i} \cdot CA_i \quad (18)$$

where CA_i denotes the carbon allowance in €/kg for a year i (Figure 6), $TE_{A,i}$ denotes the annual tailpipe emissions in kg for a year i obtained from the LCA results, and t refers to the years of ship lifetime.

2.3.3. LCCA of battery-powered ships

The investment costs of the battery-powered ship configurations (IC_B) are estimated according to the study conducted by Christos [60], in which the investment cost to retrofit a diesel-engine-powered ferry into a battery-powered ferry is estimated. Roughly 45% of this cost is associated with the battery cost, while the remainder refers to the costs of the procurement and installation of the electric motors, converters and regulators. Based on this relation, the investment cost is calculated according to the following equation:

$$IC_B = \frac{BP \cdot BC}{0.45}, \quad (19)$$

where BP denotes the battery price and BC is calculated with eq. (13). The annual electric power cost EPC_A for different vessels can be calculated according to:

$$EPC_A = EC_{BAT,A} \cdot EPP, \quad (20)$$

where $EC_{BAT,A}$ is calculated with eq. (12), while EPP denotes electric power price and it differs for different countries. Even though the configuration is considered to be virtually maintenance-free, a battery replacement should be considered in the overall maintenance cost. Based on the forecast from study by Tsiropoulos et al. [61], for 2030 the battery price (BP_{2030}) should be reduced to around €169/kWh which is then multiplied by the BC in order to obtain the maintenance cost (MC_{BAT}):

$$MC_{BAT} = BP_{2030} \cdot BC. \quad (21)$$

2.3.4. LCCA of PV cells battery-powered ships

Life-cycle costs of a PV cells battery-powered ship are similar to those of a battery-powered ship, but additionally, the investment cost in the PV system, the maintenance costs related to the PV systems, as well as the reduced energy consumption should be accounted for. The annual electric power cost $EPC_{PV-BAT,A}$ for this option is also lower and is then calculated according to:

$$EPC_{PV-BAT,A} = EC_{PV-BAT,A} \cdot EPP, \quad (22)$$

where $EC_{PV-BAT,A}$ is calculated with eq. (15). The investment cost of a PV cells battery-powered ship is obtained by summing up the investment cost of a battery-powered retrofit and the investment cost of a PV system (IC_{PV}), which is calculated according to:

$$IC_{PV} = A_{PV} \cdot PVP, \quad (23)$$

where A_{PV} denotes the area covered by the PV cells in m^2 and PVP denotes the PV system price in €/m². The annual maintenance cost represents a smaller percentage of investment

costs. Manufacturers of PV cells provide a 20-year warranty for PV systems and accordingly the replacement cost for PV cells is calculated. In order to determine the maintenance cost for the entire PV cells battery-powered ship, both the maintenance cost of the PV cells and the replacement of the battery cost should be considered.

3. Case study – The Croatian inland waterway vessels

The Croatian inland waterway network consists of the natural streams of the Danube River (137.5 km), Sava River (446 km), Drava River (198.6 km) and Kupa River (5 km), Figure 7. This network’s geographical position in the center of Europe represents a significant potential. However, due to different navigation conditions, technical obsolescence, and low capacity, the Croatian inland navigation is underutilized [62]. In 2017, inland navigation accounted for 24% of the total Croatian shipping sector according to the data on goods carried [63]. Apart from rivers, some Croatian inland waterway vessels operate on lakes, which are located in protected areas of nature and serve primarily for touristic purposes.



Figure 7. Inland waterway network of Croatia [62].

The Croatian inland waterway fleet is comprised of several types of ships: dredgers, tugboats (tugs and pushers), passenger ships and cargo ships, so the general model presented in Figure 1 is adapted and shown in Figure 8.

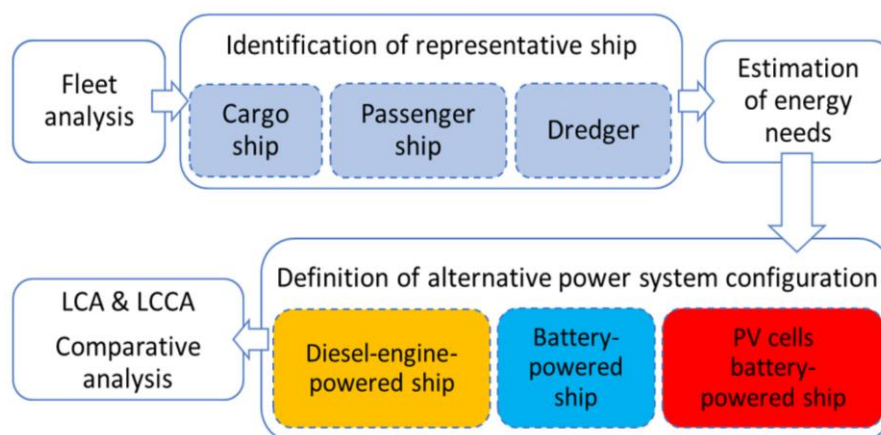

Figure 8. Procedure for the definition of the ship power system of the Croatian inland waterway fleet.

The exploitation characteristics of a ship determine the ship’s economic output and depend primarily on the ship type, Table 1. A dredger’s primary task is to reshape the

riverbed, while tugboats are ships tasked with pushing and/or tugging ships, barges or other vessels. Passenger ships are used to transport passengers and most of them sail in protected areas of nature, while cargo ships are used to transport different types of cargo. All vessels use high-speed four-stroke diesel engines connected via a gearbox to the propeller (diesel-mechanical propulsion) [64]. The average age of ships in the fleet is around 40 years, implying that they will soon need to be replaced by new ships, or at least retrofitted with new power systems. Since the profitability of this sector is relatively low, the latter option seems to be more realistic. This represents an opportunity to introduce new energy-efficient and greener technologies, which is very important bearing in mind overall European goals to shift a significant portion of road transportation to inland waterways where possible.

Table 1. The Croatian inland waterway fleet by ship type and their exploitation characteristics.

Ship type	Number of ships	Exploitation characteristics
Dredger	19	Power, operating time
Tugboat	8	Power, operating time
Passenger ship	8	Speed, number of passengers, route
Cargo ship	3	Speed, capacity, route

The economic output of dredgers and tugboats is expressed in the specific task they should accomplish during their operation. The economic output of passenger ships is expressed in the number of passengers transported over a certain distance, while for cargo ships it is similarly expressed in the cargo carried over a certain distance. The selected representatives are shown in Figure 9.



Figure 9. Selected ships in operation: (a) cargo ship “Opatovac” [65], (b) passenger ship “Trošeni” [66], (c) dredger “Papuk” [67].

Considering the exploitation characteristics of each representative, the average and annual energy consumption is calculated. The representatives’ particulars are presented in Table 2, as obtained from [64]. Additional data on their exploitation were gathered from the shipowners.

Table 2. Particulars of the selected ships.

	Cargo ship	Passenger ship	Dredger
Length overall (m)	75.9	13.2	68.94
Breadth (m)	9.0	4.12	9.30
Deadweight (t)	967	15.72	484.6
Main engine(s) maximum continuous rating (kW)	855	236	804
Auxiliary engine(s) maximum continuous rating (kW)	100	-	476
Total power installed (kW)	955	236	1,280

The representative of cargo ships is the tanker named “Opatovac”. It is mostly used to transport oil between two Croatian refineries, covering a distance of about 223 km. On

average, it performs 20 round trips annually. The ship speed depends on the river environment. The average speed of a cargo ship of this size is 14.4 km/h, with an average main engine load as 75% of the maximum continuous rating [68]. With an average speed of the Sava River of 1 m/s [69], the estimated average duration of the trip is 20.5 h for upstream and 12.5 h for downstream navigation. The average load of the auxiliary engines is estimated at 50% of the maximum continuous rating. The average ship power is determined by eq. (1). After calculating the P_{ave} , the ship energy consumption per distance travelled is calculated according to eq. (4). Since the observed tanker sails on rivers, its annual energy consumption is calculated according to eq. (5), while its FOC for both for the upstream and for the downstream journey is calculated according to eq. (6).

The representative of passenger ships is the ship named “Trošenj”, which operates in Krka National Park. The river speed is very low on this 5 km route, so it is not taken into account, i.e. the power for both upstream and downstream sailing is considered to be equal. It takes around 20 minutes for a one-way trip, with an average speed of 15 km/h. On an annual basis, the ship sails around 2,190 round trips, depending on the weather [58]. It is assumed that the ship operates at 70% of the total installed power. In a similar way as for the cargo ship, the annual energy consumption of the passenger ship is calculated according to eq. (7).

The representative of working ships is the dredger named “Papuk”. Since this kind of vessel belongs to stationary units, a modified approach, explained in the previous section, is applied. The annual fuel oil consumption of this ship equals 63,023 liters as reported by the shipowner. With the assumption that the average load of the ship power system is 50% of the rated load, the time that the dredger spends in operation is approximately determined according to eq. (8). Therefore, the annual energy consumption of the dredger is calculated according to eq. (9).

After estimating the energy consumption of each representative, it is possible to define different power configurations. In this paper, three power configurations are analyzed and compared. As a conventional power configuration, a diesel-powered ship was selected. Furthermore, the diesel-powered configuration is compared to two alternatives, a battery-powered ship and a PV cells battery-powered ship. The environmental impact of each power configuration is assessed by the LCA method and the LCCA method is applied for estimating all relevant costs during the operation time.

3.1. LCA of the Croatian waterway fleet

As shown in the previous section, the current Croatian fleet should be retrofitted, so the applicability of different power system configurations for retrofitting three different ships is investigated. Since the emphasis is on a comparison of different retrofitting options, only emissions related to power system configurations are taken into account.

3.1.1. LCA of diesel-engine-powered ships

The first option considered in this paper is to retrofit the selected ships with new diesel engines. MAN high-speed four-stroke heavy-duty diesel engines are considered with the corresponding power outputs based on the manufacturer’s data [70], Table 3.

Table 3. Engines selected for retrofit.

Ship	Opatovac	Trošenj	Papuk
Ship type	Tanker	Passenger	Dredger
Selected engine model	MAN D2862 LE444	MAN D2676 LE461	MAN D2676 LE421
Engine power, kW	735	147	382
Engine weight, kg	2,270	1,215	1,215
Engine cost, €	159,000	69,000	77,000
Number of engines	1	2	3

The environmental impact of diesel engines was assessed by observing the manufacturing process and considering the weight ratios of material contents in the engine as proposed by Jeong et al. [71]. In order to calculate the weights of the engine materials, these ratios were multiplied by the weight of the engine. The materials' manufacturing process parameters were obtained from the GREET 2020 database.

The Croatian inland waterway fleet uses "Eurodiesel Blue" as fuel oil. This fuel oil is diesel colored with blue dye according to the Regulation on the Implementation of Excise Duty Act [72]. According to viscosity, it corresponds to Conventional Diesel from the GREET 2020 database, from where the parameters are obtained to describe the process of diesel refining and the process of crude oil recovery. Crude oil used for the production of "Eurodiesel Blue" in Croatia is primarily imported from the Middle East since domestic crude oil production is not sufficient for the Croatian needs. It is considered that crude oil is transported via tankers and pipelines from the Middle East to Croatia. For reasons of simplicity, it is assumed that the diesel is produced only in the Rijeka refinery [73]. After the diesel is produced, tank trucks transport it to the gas stations. This distance is different for each considered ship because it depends on where the ship is refueling. Therefore, this distance for the cargo ship is 200 km (from Rijeka to Sisak), for the passenger ship it is 300 km (from Rijeka to Šibenik) and for the dredger it is 450 km (from Rijeka to Osijek). Tail-pipe emissions released during the vessel operation are calculated according to eq. (10).

3.1.2. LCA of battery-powered ships

The battery-powered ship configuration has a simpler life-cycle. As explained in the previous sections, a fully electric ship has zero PTW emissions and the manufacturing emissions depend on the type of battery that is being implemented.

As one of the issues, the battery capacity was mentioned. In this case study, three different types of ships are being researched. It is assumed that the capacity of the battery should be sufficient for the cargo ship to sail one-way upstream without recharging, with an average speed over ground of 10.9 km/h, i.e. an average speed over water of 14.4 km/h. As for the passenger ship, it is assumed that the battery is charged after a round trip, while for the dredger the battery should have enough capacity to allow it to operate for 8 hours without recharging. The calculations are carried out according to eq. (13). The next step is to calculate the weight of the batteries with the assumed power density of 0.25 kWh/kg. The battery manufacturing process parameters are obtained from the GREET 2020 database.

The WTP of electricity is the main emission contributor in a battery-powered configuration. As said in the previous section, it depends on the electricity generation process in the country where is being implemented. The main energy sources for the Croatian electricity generation are shown in Figure 10, except for nuclear energy which is not produced in Croatia [74]. In order to describe the electricity generation process in GREET 2020, data on the Non-distributed U.S. Mix were used, where the shares of electricity generation sources were replaced with the shares characteristic of Croatia.

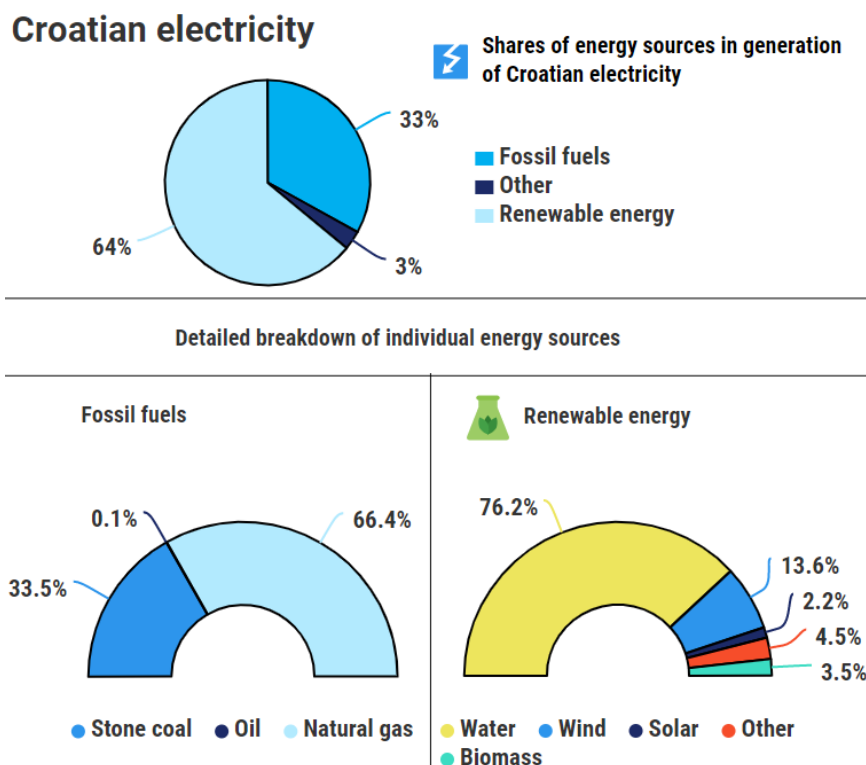

Figure 10. The Croatian electricity mix

3.1.3. LCA of PV cells battery-powered ships

As described in previous sections, besides the battery, the manufacturing process of PV cells has a high role in the total lifetime emissions. In this assessment, crystalline silicon (c-Si) cells were used due to their low cost, high density, efficiency and suitability for use on horizontal surfaces [75]. Their efficiency ranges from 12% to 19% [76]. They consist of glass for the panel surface (76%), polymer (10%), aluminum for the frame (8%), silicon for the PV cells (5%), and copper for the interconnectors (1%) [77]. According to some commercial c-Si PV panels, the module of 1.64 m² weights 19.5 kg, which is used to calculate the weight of PV module materials (glass, aluminum, silicon and copper) [78]. Their manufacturing process parameters are obtained from the GREET 2020 database.

Another factor that affects the efficiency of the system is the average annual solar irradiance. Data for the case of Croatia are obtained from the Climate Atlas of Croatia [79].

3.2. LCCA of the Croatian waterway fleet

LCCAs of different power system configurations implemented on the Croatian inland waterway vessels are performed. It is assumed that the lifetime of each retrofitted vessel is 20 years. Therefore, the results of the LCCA refer to the total costs during that time.

3.2.1. LCCA of diesel-engine-powered ships

A major part of the investment cost is the engine procurement and installation, but in this case study the purchasing costs that will be presented consider only the engine purchase. Due to that, they are increased by 40% to take into account additional equipment connected to the engine, the installation cost, and the gearbox cost. The annual maintenance cost is assumed to be 7.5% of the total installation cost.

In term of operational characteristics, the Croatian fleet uses the “Eurodiesel Blue” with the price of €0.66/l, taking into account the reduction in the excise duty [80]. Considering the operational characteristics of each ship, the annual fuel oil consumption cost in € can be calculated. For the cargo and passenger ship the equation (14) considers the characteristics of the routes, while the calculation of the dredger, eq. (15), is determined with the annual operating time.

602
603
604
605
606
607
608
609
610
611
612
613
614
615
616
617
618
619
620
621
622
623
624
625
626
627
628
629
630
631
632
633
634

3.2.2. LCCA of battery-powered ships

The investment costs include all cost connected to the replacement of a diesel-powered system with a battery-powered. This includes the battery procurement and, in this case, the battery price is assumed to be €200/kWh [61]. Another major factor in the cost assessment is the electric power price. For the Croatian industrial sector, the electric power price equals €78/MWh [80] and, accordingly to eq. (18), the annual electric power cost for different vessels can be calculated. Considering that the assumed lifetime of a vessel is 20 years and a lifetime of a Li-ion battery is assumed to be 10 years [81], the battery replacement is also included in the LCCA as a significant maintenance cost.

3.2.3. LCCA of PV cells battery-powered ships

Similar to the calculations of a battery-powered ship, the total costs of a PV cells battery-powered ship include the investment and maintenance cost of a battery-powered configuration and the addition in costs of a PV system. The annual electric power cost is calculated according to eq. (22) and it includes the electric power price as indicated in the previous section.

In this paper, it is assumed that the PV system price equals €165/m². This price is obtained according to the World Energy Outlook 2018 for the European Union [59], taking into account the average electric power which c-Si PV cells can convert from solar energy per 1 m² [76]. The annual maintenance cost is assumed to be 5% of investment costs, which is calculated according to eq. (23). Manufacturers of PV cells provide a 20-year warranty for PV systems, which is the expected lifetime of the considered ships. Hence, the replacement cost for PV cells is not taken into account. In order to determine the maintenance cost for the entire PV cells battery-powered ship, both the maintenance cost of the PV cells and the replacement of the battery cost should be considered.

4. Results

4.1. LCA comparison

In order to evaluate the environmental impact of different power system configurations to retrofit the three selected ships, LCAs were performed. The input parameters for LCAs are presented in Table 4, in which C denotes the observed cargo ship, P denotes the passenger ship, and D denotes the dredger. For the passenger ship, it is not possible to calculate the energy consumption upstream or downstream since it sails on a lake. Any input data that refers to sailing is not applicable (N/A) for the dredger since it mainly operates while stationary.

Table 4. Diesel engine-powered ship input data for LCA.

	C	P	D
Length of a round trip, L_{RT} (km)	446	10	N/A
Annual number of round trips, N_{RT}	20	2,190	N/A
Average ship speed, v (km/h)	14.4	15	N/A
Average total power, P_{ave} (kW)	691	165	640
Annual operating time, t_A (h)	660	1,460	387
	Upstream (kWh/km)	N/A	N/A
Energy	Downstream (kWh/km)	N/A	N/A
consumption, EC	Average (kWh/km)	11	N/A
	Annual (kWh)	455,812	240,900
Density of diesel, ρ (kg/l)		0.845	
	Upstream (kg/km)	13.6	N/A

Fuel oil	Downstream (kg/km)	8.3	N/A	N/A
consumption, <i>FOC</i>	Average (kg/km)	11.0	2.4	N/A
	Annual (l)	116,118	62,201	63,023

First, the diesel-engine-powered ship configuration is considered, as the referent one. Based on the weight of diesel engines, the weights of different components are calculated. Emissions released during the manufacturing processes of these materials represent the environmental impact of diesel engines. During navigation, ships emit a high amount of tailpipe emissions, which are calculated by using eq. (10) and are presented in Table 5.

Table 5. Calculated tailpipe emissions from the considered diesel-engine-powered ships.

Emission	GWP	Emission factor (g emission/kg diesel)	Tailpipe emissions			
			Cargo ship(g/km)		Passenger ship (g/km)	Dredger (g/h)
			Upstream	Downstream		
CO ₂	1	3,206	43,602	26,610	7,694	441,172
CH ₄	25	0.06	0.816	0.498	0.14	8.26
N ₂ O	298	0.15	2.04	1.245	0.36	20.64
NO _x	N/A	61.21	832.46	508.04	146.90	8,423.01
SO _x	N/A	2.64	35.90	21.91	6.34	363.29
PM10	N/A	1.02	13.87	8.45	2.45	140.36

The first alternative for the retrofit is the battery-powered ship configuration. The battery power output and the energy consumption are calculated for each ship according to the methodology described in section 2 and are presented in Table 6, together with the weight and capacities of the batteries.

The application of solar energy for power generation onboard and the Li-ion battery was considered as the second alternative for the retrofit. The required power needs and battery capacities for the PV cells battery-powered ship are the same as for the battery-powered ship, Table 6. Average annual solar irradiances, available areas for PV system installation, and PV system efficiency, presented in Table 7, are used to calculate the average electric energy produced from the PV system according to eq. (14). In addition, the PV system power outputs, the battery power outputs, energy consumption, and the PV system weight are all calculated according to the methodology described in section 2 and are presented in Table 7.

Table 6. Battery-powered ship input data for LCA.

	C	P	D
Average battery power output, $P_{BAT,ave}$ (kW)	760	182	704
Energy consumption, EC_{BAT} (kWh/km)	69.7	12.1	N/A
Annual energy consumption, $EC_{BAT,A}$ (kWh)	621,724	264,990	272,448
Battery capacity, BC (MWh)	19.42	0.15	7.04
Battery weight (t)	77.7	0.6	28.2

Table 7. PV cells battery-powered ship input data for LCA.

	C	P	D
Average annual solar irradiance, E_{rad} (kJ/m ²)	4,499,000	5,190,000	4,544,000
Installation area for PV cells, A_{PV} (m ²)	360	12	330
PV cells efficiency, η_{PV}		0.155	
Annual electric energy produced by PV cells, $E_{PV,A}$ (GJ)	251.0	9.6	232.4
Energy consumption of PV cells battery-powered ships, EC_{PV-BAT} (kWh/year)	551,989	262,309	207,885

PV system weight (t)	4.3	0.16	3.9
----------------------	-----	------	-----

The results of the LCAs represent the lifetime emissions of each option released during different stages of the life-cycle of the considered ship. All these results are summarized in Figure 11, where DE denotes diesel engine-powered ship, BAT refers to a battery-powered ship, while PV-BAT denotes PV-cells battery-powered ship.

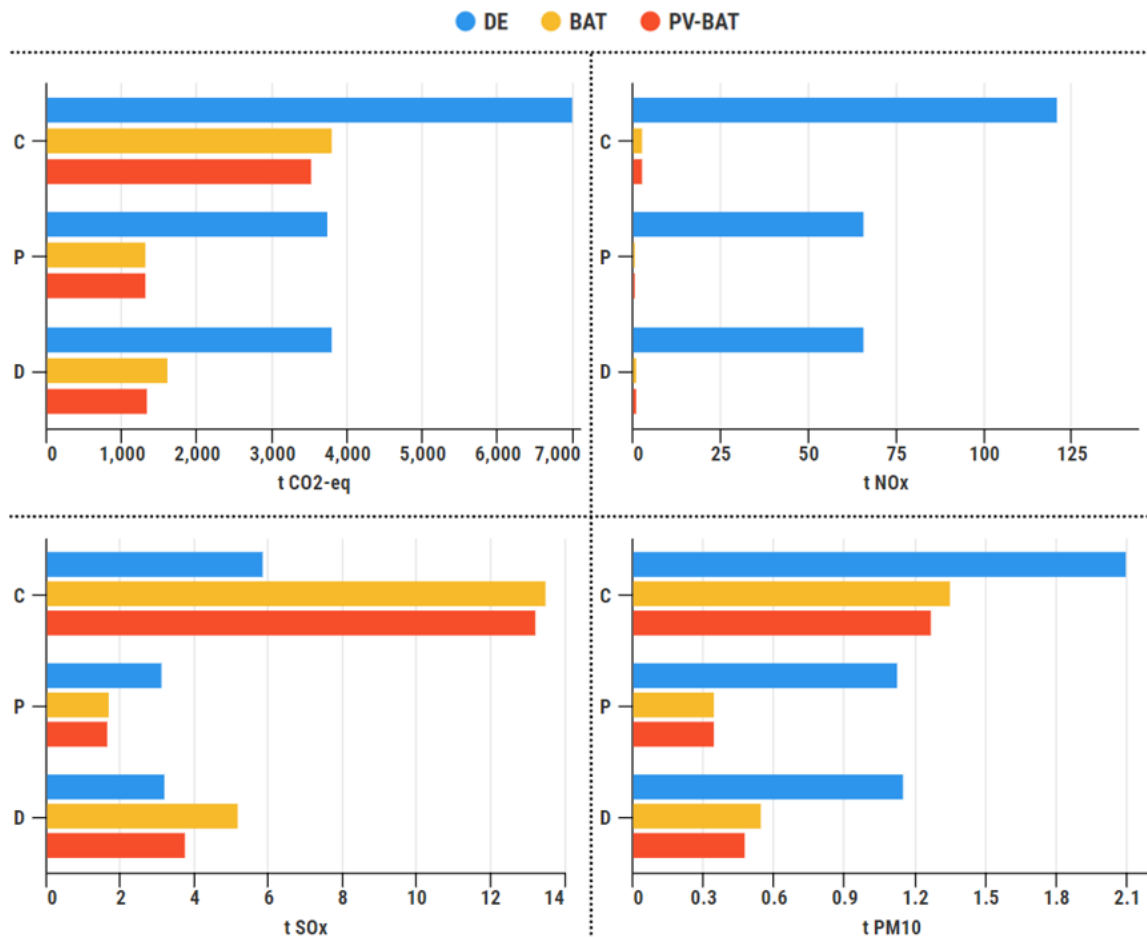

Figure 11. Lifetime emissions of the considered ships with different power system configurations.

A complete insight into the feasibility of the proposed solutions is achieved by comparing them from the economic viewpoint, which is presented in the following section.

4.1. LCCA comparison

LCCA comparisons of different power system configurations that can be implemented onboard three observed ships are performed. As indicated in the previous section, LCCA involves the investment cost and the exploitation costs which consist of the power source cost, the maintenance cost, and the carbon credit cost. In this paper, four carbon credit scenarios for diesel-engine-powered ships are investigated, Table 8. Since the SD scenario is very rigorous and has the highest costs of carbon credit, only this scenario was incorporated in the LCCs of the diesel-engine-powered ship.

Table 8. Carbon credit cost for diesel-engine-powered ships, (€).

	NT	CP	NP	SD
C	0	163,312	185,210	422,754
P	0	87,455	99,182	226,389

D	0	88,609	100,4910	229,377
---	---	--------	----------	---------

Annual costs are calculated according to section 2 and are summed up throughout the ship's lifetime in order to obtain the LCCs. The LCCA comparison of the power system configuration implemented on the considered ships is presented in Figure 12.

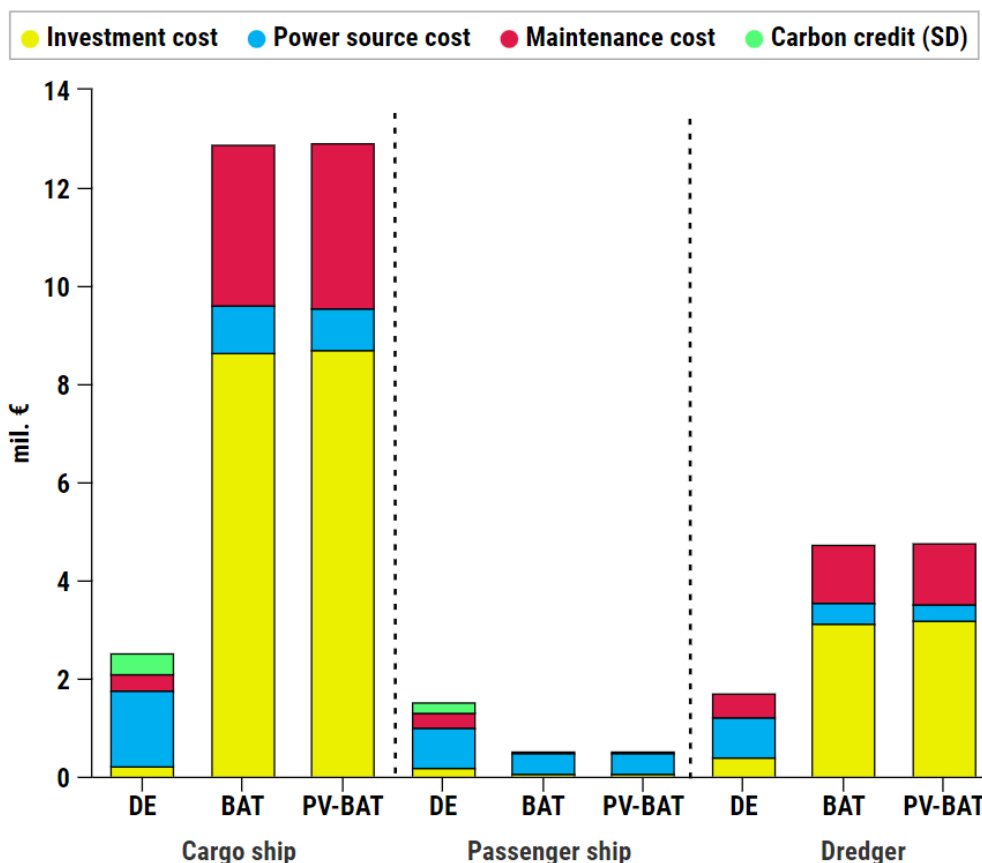

Figure 12. LCCA comparison of different power system configurations for the retrofit of the selected ships.

5. Discussion

Based on the LCA results presented in the previous section, it can be observed that diesel-engine-powered ships make the highest contribution to GHGs, PM10 and NO_x emissions. With the application of alternative power system configurations, the environmental impact can be significantly reduced. However, the alternatives implemented on the cargo ships and the dredger result in higher SO_x emissions than the existing diesel engine-powered ship. The main reason for that is the required large capacity of the battery, whose manufacturing process releases a great amount of SO_x emissions into the atmosphere. Since passenger ship requires a battery of small capacity, among considered different power systems onboard, the main contributor to SO_x emissions is the diesel engine power system configuration. Regarding all considered emissions, the PV-BAT configuration results in the lowest lifetime emissions among different considered power system configurations. It can be noticed in Figure 11 that the impact of the installation of PV cells is less pronounced for the passenger ship due to the relatively small area which can be covered by PV cells. In addition, due to the high battery capacity required for a cargo ship and dredger, the impact of the battery manufacturing process is also relatively high, especially when compared with the diesel engine.

According to the LCCA, it is evident that diesel engine options for both the cargo ship and the dredger have the lowest LCCs compared to alternative power system configurations. The greatest difference in the LCCs between the different configurations is shown for the cargo ship, where the LCCs of the PV cells battery-powered ship is equal to €12.9 million, while for the diesel-engine-powered ship the LCCs is €2.1 million (in the NT scenario). The primary reason for this discrepancy is the high cost of the battery. A reduction in battery capacity would lead to a reduction in the investment cost. This could be achieved by reducing the required sailing distance (which is defined by market needs and is unlikely to be reduced) or by reducing the speed. The upstream speed over water for which energy consumption is the lowest can be calculated by minimizing the ratio of the required power output and the sailing time, and equals 150% of the river speed, i.e. 1.5 m/s. This would significantly reduce the power output to around 40 kW, but also extend the trip duration six times to roughly five days. In this extreme scenario, the battery capacity could be reduced by almost 70%, resulting in the LCC of a battery-powered cargo ship of around €4 million. This is still higher than the diesel engine option, but at least opens the possibility for the use of the battery in the future, providing the battery price decreases or some environmentally oriented policies are introduced. An example of such a policy is shown in the analysis of carbon credit, Figure 6. Even though its impact is not crucial, it still makes alternative options a little more appealing.

On the other hand, the most cost-effective option for the passenger ship is the PV cell battery-powered ship. Due to its smaller size and relatively low requirements regarding autonomy, the battery capacity is quite low and the installation area for PV cells is smaller. Hence, both the investment and maintenance costs are low. It should also be mentioned that currently there are several passenger ships in operation in Krka national park. They are used depending on the number of tourists (varying both during the season and during the week) as well as the maintenance schedule. Since the PV cells battery-powered ship seems to be more cost-effective if used more often, it can be aimed at the transportation of tourists. If occasionally additional vessels are required, the currently used vessels with diesel engines could be employed. It is also worth mentioning that the noise and vibrations emitted from PV cells battery-powered ships are significantly lower, thus increasing the level of comfort for both passengers and crew on board.

Another reason why the PV cells battery option seems feasible only for passenger ships is battery utilization. The observed passenger ship sails around 1,500 h annually, while the dredger is used for less than 400 h annually. Additionally, the passenger ship needs autonomy for a round trip (roughly 1 h), while the dredger requires autonomy of at least 8 h. Hence, the battery capacity for the dredger is around 50 times higher, while the total annual energy consumption is in fact even higher for the passenger ship, as can be observed in Table 7. This increase in capacity leads both to an increase in weight (which is not crucial for marine application) and to an increase in the investment cost which makes the battery option unfeasible both for the cargo ship and the dredger.

A possible option to reduce the lifetime emissions and the LCCs of the dredger is to use shore-side electricity to satisfy its power needs. This requires an appropriate power grid which can sustain such power surges and obviously limits the area of dredging operations. Therefore, a solution can be found in the implementation of a HPS. Such a HPSs should be designed by applying proper bi-objective optimization procedures, considering not only fuel consumption but also lifetime emissions [82]. When the ship operates in populated areas (where electricity is available) it could use shore power, while to operate in other areas it can be powered by a diesel engine. Such a solution would increase the investment costs compared to the diesel-engine-powered option since the ship would have both diesel engines and a battery (although of lower capacity) with the appropriate electrical equipment. The advantage can be seen from the environmental point of view since this option would not pollute the environment in highly populated areas. Such advantages should be recognized by national authorities in adopting appropriate policies leading to sustainable development.

However, Croatia, like many other EU states, currently implements policies which encourage the application of diesel in the shipping sector. The last available data for 2016 [80] estimates fossil fuel subsidies in the EU at around €55 billion (an amount which is not declining). The EU has called for these subsidies to be removed as they hamper the implementation of innovative energy-efficient technologies. As described before, the inland fleet in Croatia uses the same fuel as road vehicles. But the price of this fuel for road vehicles is almost twice as high when compared with marine application. Additionally, Croatia has offered on several occasions state aid to cover up to 40% of the purchase price of electric vehicles. Such opportunities have never been presented to shipowners. In short, the current Croatian policy stimulates electric vehicles and diesel-powered vessels.

If the policy were changed, i.e. if the fuel oil price for marine application were the same as for road vehicles (€1.18) [80], and if the subsidies covering 40% of the investment costs for battery and PV systems were introduced, the LCCs would change significantly. The estimates are presented in Table 9.

As can be observed, with the application of state aid, the electrification of the passenger ship becomes more attractive, since now the LCCs of the electrification options are around four times lower than the LCCs of the diesel-engine-powered passenger ship. The differences between the LCCs of a diesel-engine power system configuration and the LCCs of alternative power configurations implemented on the cargo ship and dredger are lower, especially for the dredger whose LCCs of alternative power system configurations are around 30% higher than the LCCs of the diesel engine-powered dredger. As for the cargo ship, the LCCs are not low enough for shipowners to willingly implement these solutions to reduce the lifetime emissions.

Table 9. Policy impact on LCCs of the considered options.

Power system configuration	Investment cost (€)	Power source cost, (€)	Maintenance cost (€)	Carbon credit cost (SD) (€)	Total costs, (€)	
C	DE	222,600	2,727,900	333,900	422,700	3,707,100
	BAT	5,181,000	969,900	3,283,500	0	9,434,400
	PV-BAT	5,216,700	861,100	3,342,900	0	9,420,700
P	DE	193,200	1,467,900	289,800	226,400	2,177,370
	BAT	40,300	413,400	25,500	0	479,200
	PV-BAT	41,500	409,200	27,500	0	478,200
D	DE	323,400	1,487,300	485,100	229,400	2,525,200
	BAT	1,877,300	425,000	1,189,800	0	3,492,100
	PV-BAT	1,910,000	324,300	1,244,200	0	3,478,500

6. Conclusion

This paper has assessed the applicability of different power system configurations for the electrification of three different ships engaged in the Croatian inland waterway sector. Consideration was given to retrofitting three ship types: a cargo ship, a passenger ship and a dredger, based on three different power system configurations, namely diesel engines, a battery, and a PV system. While the most ecological solution was established by LCA, through LCCA the most economical solution for retrofitting these ships is highlighted. The main findings of this study can be summarized as follows:

- the most environmentally friendly solution is the PV cells battery-powered ship for each considered ship;
- electrification of inland vessels results in GHGs reduction up to 64% and NO_x emissions reduction up to 99%;
- the diesel engine option is still by far the most economical solution both for the cargo ship and the dredger;

- for the passenger ship, the PV cells battery option seems to be the most cost-effective solution;
- currently in Croatia, given that diesel fuel for inland waterways shipping is free of excise duty and there are no incentives to introduce green technologies, the national policy actually encourages shipowners to use diesel engines.

The main difference between the passenger ship on the one hand and the cargo ship and the dredger on the other lies in the required autonomy. The passenger ship sails on shorter routes and has the option of recharging more often, resulting in a required autonomy of around one hour. Hence, its battery capacity is lower, resulting in lower capital, as well as lower maintenance costs. Additionally, greater use is made of the passenger ship, confirming that high investments are justified only if high savings can be achieved. For the dredger, which operates less than 400 hours annually and would require a battery of very high capacity, this is simply not a feasible option. It would perhaps be more appropriate to retrofit it with a HPS, although this option should be further analyzed. It might also be beneficial to adapt national policies in order to promote green technologies, instead of encouraging the use of fossil fuels, as is currently the case in Croatia. Finally, the presented model can be applied to analyze the viability of electrification of any other inland waterway fleet, if a relevant set of input parameters is known.

Author Contributions: Conceptualization, M.P. and N.V.; methodology, M.P. and N.V.; software, M.P.; validation, M.P., N.V., and M.K.; formal analysis, M.P. and N.V.; investigation, M.P.; resources, M.P.; data curation, M.P. and N.V.; writing—original draft preparation, M.P.; writing—review and editing, M.P., N.V. and M.K.; visualization, M.P. and N.V.; supervision, N.V.; project administration, N.V.; funding acquisition, N.V. All authors have read and agreed to the published version of the manuscript.

Funding: This research was funded by the Croatian Science Foundation under the project Green Modular Passenger Vessel for Medi-terranean (GRiMM), (Project No. UIP-2017-05-1253). Maja Perčić, a Ph.D. student, is supported through the “Young researchers' career development project – training of doctoral students” of the Croatian Science Foundation, funded by the European Union from the European Social Fund. The research was also funded through the Croatian-Chinese bilateral project “Energy efficient and environmentally friendly power system options for inland green ships” conducted by the University of Zagreb, Faculty of Mechanical Engineering and Naval Architecture (Croatia), and Wuhan University of Technology (China).

Acknowledgments: This research was supported by the Croatian Science Foundation under the project Green Modular Passenger Vessel for Mediterranean (GRiMM), (Project No. UIP-2017-05-1253) as well as within the Croatian-Chinese bilateral project “Energy efficient and environmentally friendly power system options for inland green ships” conducted by the University of Zagreb, Faculty of Mechanical Engineering and Naval Architecture (Croatia), and Wuhan University of Technology (China). The authors are grateful to Dr. Ivica Ančić, Assistant Professor at the University of Rijeka, Croatia, for valuable discussions related to the determination of energy needs and fuel consumption of the considered inland vessels.

In this paper, LCAs were performed by GREET 2020 software produced by UChicago Argonne, LLC under Contract No. DE-AC02-06CH11357 with the Department of Energy.

Conflicts of Interest: The authors declare no conflict of interest.

1. European Court of Auditors (ECA). Inland Waterway-Transport in Europe: No significant improvements in modal share and navigability conditions since 2001. Available online: https://www.eca.europa.eu/Lists/ECADocuments/SR15_01/SR15_01_EN.pdf (accessed on 15 July 2021). 892
2. Wiegman, B.; Witte, P.; Spit, T. Inland port performance: a statistical analysis of Dutch inland ports. *Transportation Research Procedia* **2015**, *8*, 145-154. 893
3. Christodoulou, A.; Christidis, P.; Bisselink, B. Forecasting the impacts of climate change on inland waterways. *Transportation Research Part D: Transport and Environment* **2020**, *82*, 102159. 894
4. Xing, S.; Xinping, Y.; Bing, W.; Xin, S. Analysis of the operational energy efficiency for inland river ships. *Transportation Research Part D: Transport and Environment* **2013**, *22*, 34-39. 895
5. Ančić, I.; Perčić, M.; Vladimir, N. Alternative power options to reduce carbon footprint of ro-ro passenger fleet: A case study of Croatia. *Journal of Cleaner Production* **2020**, *271*, 122638. 896
6. Lindstad, H.; Jullumstrø, E.; Sandaas, I. Reductions in cost and greenhouse gas emissions with new bulk ship designs enabled by the Panama Canal expansion. *Energy Policy* **2013**, *59*, 341-349. 897
7. Miola, A.; Ciuffo, B. Estimating air emissions from ships: Meta-analysis of modelling approaches and available data sources. *Atmospheric Environment* **2011**, *45*, 2242-2251. 898
8. Ammar, N.R.; Seddiek, I.S. Eco-environmental analysis of ship emission control methods: Case study RO-RO cargo vessel. *Ocean Engineering* **2017**, *137*, 166-1673. 899
9. Chen, J.; Fei, Y.; Wan, Z. The relationship between the development of global maritime fleets and GHG emission from shipping. *Journal of Environmental Management* **2019**, *242*, 31-39. 900
10. Keuken, M.P.; Moerman, M.; Jonkers, J.; Hulskotte, J.; Denier van der Gon, H.A.C.; Hoek, G.; Sokhi, R.S. Impact of inland shipping emissions on elemental carbon concentrations near waterways in The Netherlands. *Atmospheric Environment* **2014**, *95*, 1-9. 901
11. Ya-li, C.; Xia, W.; Cheng-qi, Y.; Wen-wen, X.; Wen, S.; Guang-ren, Q.; Zhi-meng, X. Inland Vessels Emission Inventory and the emission characteristics of the Beijing-Hangzhou Grand Canal in Jiangsu province. *Process Safety and Environmental Protection* **2018**, *113*, 498-506. 902
12. International Maritime Organization. Resolution MEPC.176(58), London, UK, 2008. 903
13. Chen, L.; Yip, T.L.; Mou, J. Provision of Emission Control Area and the impact on shipping route choice and ship emissions. *Transportation Research Part D: Transport and Environment* **2018**, *58*, 280-291. 904
14. Emission Standards: IMO Marine Engine Regulations. Available online: <https://dieselnet.com/standards/inter/imo.php#s> (accessed on 05 October 2021). 905
15. Sofiev, M.; Winebrake, J.J.; Johansson, L.; Carr, E.W.; Prank, M.; Soares, J.; Vira, J.; Kouznetsov, R.; Jalkanen, J.-P.; Corbett, J.J. Cleaner fuels for ships provide public health benefits with climate tradeoffs. *Nature Communications* **2018**, *9*, 406. 906
16. Gobbi, G.P.; Di Liberto, L.; Barnaba, F. Impact of port emissions on EU-regulated and non-regulated air quality indicators: The case of Civitavecchia (Italy). *Science of the Total Environment* **2020**, *719*, 134984. 907
17. Rehmatulla, N.; Calleya, J.; Smith, T. The implementation of technical energy efficiency and CO2 emission reduction measures in shipping. *Ocean Engineering* **2017**, *139*, 184-197. 908
18. Bouman, E.A.; Lindstad, E.; Riialand, A.I.; Strømman, A.H. State-of-the-art technologies, measures, and potential for reducing GHG emissions from shipping – A review. *Transportation Research Part D: Transport and Environment* **2017**, *52*, 408-421. 909
19. Corbett, J.J.; Wang, H.; Winebrake, J.J. The effectiveness and costs of speed reductions on emissions from international shipping. *Transportation Research Part D: Transport and Environment* **2009**, *14*, 593-598. 910
20. Lindstad, H.; Asbjørnslett, B.E.; Strømman, A.H. Reductions in greenhouse gas emissions and cost by shipping at lower speeds. *Energy Policy* **2011**, *39*, 3456-3464. 911
21. Perčić, M.; Vladimir, N.; Fan, A. Life-cycle cost assessment of alternative marine fuels to reduce the carbon footprint in short-sea shipping: A case study of Croatia. *Applied Energy* **2020**, *279*, 115848. 912
22. Ančić, I.; Vladimir, N.; Runko Luttenberger, L. Energy efficiency of ro-ro passenger ships with integrated power system. *Ocean Engineering* **2018**, *16*, 350-357. 913
23. Psaraftis, H.N.; Zis, T.; Lagouvardou, S. A comparative evaluation of market based measures for shipping decarbonization. *Maritime Transport Research* **2021**, *2*, 100019. 914
24. Gagatsi, E.; Estrup, T.; Halatsis, A. Exploring the potentials of electrical waterborne transport in Europe: the E-ferry concept. *Transportation Research Procedia* **2016**, *14*, 1571-1580. 915
25. Perčić, M.; Ančić, I.; Vladimir, N. Life-cycle cost assessments of different power system configurations to reduce the carbon footprint in the Croatian short-sea shipping sector. *Renewable and Sustainable Energy Reviews* **2020**, *131*, 110028. 916
26. Nuchturee, C.; Li, T.; Xia, H. Energy efficiency of integrated electric propulsion for ships – A review. *Renewable and Sustainable Energy Reviews* **2020**, *134*, 110145. 917
27. Geertsma, R.D.; Negenborn, R.R.; Visser, K.; Hopman, J.J. Design and control of hybrid power and propulsion systems for smart ships: A review of developments. *Applied Energy* **2017**, *194*, 30-54. 918
28. Lan, H.; Wen, S.; Hong, Y.Y.; Yu, D.C.; Zhang, L. Optimal sizing of hybrid PV/diesel/battery in ship power system. *Applied Energy* **2015**, *158*, 26-34. 919
29. Ghenai, C.; Bettayeb, M.; Brdjanin, B.; Hamid, A.K. Hybrid solar PV/PEM fuel Cell/Diesel Generator power system for cruise ship: A case study in Stockholm, Sweden. *Case Studies in Thermal Engineering* **2019**, *14*, 100497. 920

30. Ritari, A.; Huotari, J.; Halme, J.; Tammi, K. Hybrid electric topology for short sea ships with high auxiliary power availability requirement. *Energy* **2020**, *190*, 116359. 951
952
31. Yuan, Y.; Wang, J.; Yan, X.; Li, Q.; Long, T. A design and experimental investigation of a large-scale solar energy/diesel generator powered hybrid ship. *Energy* **2018**, *165* (Part A), 965-978. 953
954
32. Wu, P.; Partridge, J.; Bucknall, R. Cost-effective reinforcement learning energy management for plug-in hybrid fuel cell and battery ships. *Applied Energy* **2020**, *275*, 115258. 955
956
33. Haseltalab, A.; Negenborn, R.R. Model predictive maneuvering control and energy management for all-electric autonomous ships. *Applied Energy* **2019**, *251*, 113308. 957
958
34. Diaz-de-Baldasano, M.C.; Mateos, F.J.; Núñez-Rivas, L.R.; Leo, T.J. Conceptual design of offshore platform supply vessel based on hybrid diesel generator-fuel cell power plant. *Applied Energy* **2014**, *116*, 91-100. 959
960
35. Ling-Chin, J.; Roskilly, A.P. Investigating the implications of a new-build hybrid power system for Roll-on/Roll-off cargo ships from a sustainability perspective – A lifecycle assessment case study. *Applied Energy* **2016**, *181*, 416-434. 961
962
36. Lindstad, H.E.; Eskeland, G.S.; Riialand, A. Batteries in offshore support vessels - Pollution, climate impact and economics. *Transportation Research Part D: Transport and Environment* **2017**, *50*, 409-417. 963
964
37. Wang, H.; Oguz, E.; Jeong, B.; Zhou, P. Life cycle and economic assessment of a solar panel array applied to a short route ferry. *Journal of Cleaner Production* **2019**, *219*, 471-484. 965
966
38. Tang, R.; An, Q.; Xu, F.; Zhang, X.; Li, X.; Lai, J.; Dong, Z. Optimal operation of hybrid energy system for intelligent ship: An ultrahigh-dimensional model and control method. *Energy* **2020**, *211*, 119077. 967
968
39. Lee, K.H.; Shin, D.; Yoo, D.W.; Choi, H.K.; Kim, H.J. Hybrid photovoltaic/diesel green ship operating in standalone and grid-connected mode – Experimental investigation. *Energy* **2013**, *49*, 475-483. 969
970
40. Jeong, B.; Oguz, E.; Wang, H.; Zhou, P. Multi-criteria decision-making for marine propulsion: Hybrid, diesel electric and diesel mechanical systems from cost-environment-risk perspectives. *Applied Energy* **2018**, *230*, 1065-1081. 971
972
41. Ling-Chin, J.; Heindrich, O.; Roskilly, A.P. Life cycle assessment (LCA)-from analysing methodology development to introducing an LCA framework for marine photovoltaic (PV) systems. *Renewable and Sustainable Energy Reviews* **2016**, *59*, 352-378. 973
974
42. Ančić, I.; Vladimir, N.; Cho, D.S. Determining environmental pollution from ships using Index of Energy Efficiency and Environmental Eligibility (I4E). *Marine Policy* **2018**, *95*, 1-7. 975
976
43. International Organization for Standardization (ISO 14040). Life cycle assessment. Available online: <https://web.stanford.edu/class/cee214/Readings/ISOLCA.pdf> (accessed on 16 August 2020). 977
978
44. GREET 2020. LCA software. Available online: <https://greet.es.anl.gov> (accessed on 15 October 2020). 979
45. Anderson, R.; Keshwani, D.; Guru, A.; Yang, H.; Irmak, S.; Subbiah, J. An integrated modeling framework for crop and biofuel systems using the DSSAT and GREET models. *Environmental Modelling & Software* **2018**, *108*, 40-50. 980
981
46. Obnamia, J.A.; Dias, G.M.; MacLean, H.L.; Saville, B.A. Comparison of U.S. Midwest corn stover ethanol greenhouse gas emissions from GREET and GHGenius. *Applied Energy* **2019**, *235*, 591-601. 982
983
47. Pereira, L.G.; Cavalett, O.; Bonomi, A.; Zhang, Y.; Warner, E.; Chum, H.L. Comparison of biofuel life-cycle GHG emissions assessment tools: The case studies of ethanol produced from sugarcane, corn, and wheat. *Renewable and Sustainable Energy Reviews* **2019**, *110*, 1-12. 984
985
986
48. Khan, M.I.; Shahrestani, M.; Hayat, T.; Shakoore, A.; Vahdati, M. Life cycle (well-to-wheel) energy and environmental assessment of natural gas as transportation fuel in Pakistan. *Applied Energy* **2019**, *242*, 1738-1752. 987
988
49. International Maritime Organization (IMO). Third IMO Greenhouse Gas Study, 2014. 989
50. Environmental Protection Agency. Understanding the Global Warming Potentials. Available online: <https://www.epa.gov/ghgemissions/understanding-global-warming-potentials> (accessed on 14 September 2020). 990
991
51. Zubi, G.; Dufo-López, R.; Carvalho, M.; Pasaoglu, G. The lithium-ion battery: State of the art and future perspectives. *Renewable and Sustainable Energy Reviews* **2018**, *89*, 292-308. 992
993
52. Manthiram, A. An Outlook of Lithium Ion Battery Technology. *ACS Central Science* **2017**, *3*, 1063-1069. 994
53. Energy Market Authority and Building and Construction Authority. Handbook for solar photovoltaic (PV) systems. Available online: http://www.bca.gov.sg/publications/others/handbook_for_solar_pv_systems.pdf (accessed on 01 September 2021). 995
996
54. Liu, H.; Zhang, Q.; Qi, X.; Han, Y.; Lu, F. Estimation of PV output power in moving and rocking hybrid energy marine ships. *Applied Energy* **2017**, *204*, 362-372. 997
998
55. Stiglitz, J.E.; Stern, N.; Duan, M.; Edenhofer, O.; Giraud, G.; Heal, G.; Lèbre la Rovere, E.; Morris, A.; Moyer, E.; Pangestu, M.; Shukla, P.R.; Sokona, Y.; Winkler, H. Report of the High-Level Commission on Carbon Prices. World Bank, Washington, DC, 2017. 999
1000
1001
56. Tvinnereim, E.; Mehling, M. Carbon pricing and deep decarbonisation. *Energy Policy* **2018**, *121*, 185-189. 1002
57. EU Emissions Trading System. Available online: https://ec.europa.eu/clima/policies/ets_en (accessed on 01 September 2021). 1003
58. Trivyza, N.L.; Rentizelas, A.; Theotokatos, G. Impact of carbon pricing on the cruise ship energy systems optimal configuration. *Energy* **2019**, *175*, 952-966. 1004
1005
59. International Energy Agency. World Energy Outlook 2018, <https://doi.org/10.1787/20725302>. 1006
60. Christos, B. Techno-economical feasibility study on the retrofit of double-ended Ro/Pax ferries into battery-powered ones. Diploma thesis. National Technical University of Athens, School of Naval Architecture and Marine Engineering, 2017. 1007
1008

61. Tsiropoulos, I.; Tarvydas, D.; Lebedeva, N. Li-ion batteries for mobility and stationary storage applications, JCR Science for Policy Report, European Commissio. Available online: <http://publications.jrc.ec.europa.eu/repository/bitstream/JRC113360/kjna29440enn.pdf> (accessed on 19 May 2021). 1009
1010
1011
62. Ministry of the Sea, Transport and Infrastructure of the Republic of Croatia. Inland navigation. Available online: <https://mmpi.gov.hr/more-86/unutarnja-plovidba-110/110> (accessed on 17 February 2020). 1012
1013
63. Statistical Yearbook of the Republic of Croatia. Available online: https://www.dzs.hr/Hrv_Eng/lijetopis/2018/sljh2018.pdf (accessed on 11 April 2020). 1014
1015
64. Croatian Register of Shipping. Register of inland waterway vessels. Available online: <http://www.crs.hr/Portals/0/CRS%20Knjiga%20Registra%202017.pdf?ver=2018-07-04-155704-933> (accessed on 07 May 2020). 1016
1017
65. Cargo vessel “Opatovac”. Available online: <https://www.marinetraffic.com/en/ais/details/ships/shipid:209454/mmsi:238401840/imo:0/vessel:OPATOVAC> (accessed on 07 May 2020). 1018
1019
66. National Park Krka (NP Krka). Passenger ship “Trošenj”. Available online: <http://www.npkrka.hr/stranice/izletibrodom/33.html>, <http://www.npkrka.hr/stranice/ulaz-skradin/30.html> (accessed on 14 May 2020). 1020
1021
67. Dredger “Papuk”. Available online: <http://www.hidrogradnja.hr/gallery/papuk/> (accessed on 14 May 2020). 1022
68. van Essen, H.P.; Faber, J.; Wit, R.C.N. Charges for barges? Preliminary study of economic incentives to reduce engine emissions from inland shipping in Europe, Delft, CE, 2004. 1023
1024
69. Croatian Meteorological and Hydrological Service. Hydrology sector. Available online: <https://hidro.dhz.hr/> (accessed on 17 January 2021). 1025
1026
70. MAN. Marine high speed propulsion engines. Available online: https://www.engines.man.eu/man/media/content_mediendoc/global_engines/marine/Marine Commercial 180613_web.pdf (accessed on 20 September 2020). 1027
1028
71. Jeong, B., Wang, H.; Oguz, E.; Zhou, P. An effective framework for life cycle and cost assessment for marine vessels aiming to select optimal propulsion systems. *Journal of Cleaner Production* **2018**, *187*, 111-130. 1029
1030
72. INA. Motor fuels. Available online: <https://www.ina.hr/customers/products-and-services/motor-fuels-9883/9883> (accessed on 21 September 2020). 1031
1032
73. Croatian Energy Regulatory Agency. Annual Report. Available online: https://www.hera.hr/en/docs/HERA_Annual_Report_2016.pdf (accessed on 15 March 2020). 1033
1034
74. HEP. Resources for Croatian electricity generation. Available online: <http://www.hep.hr/elektra/trziste-elektricne-energije/izvori-elektricne-energije/1553#> (accessed on 14 September 2020). 1035
1036
75. Kobougias, I.; Tatakis, E.; Prousalidis, J. PV Systems Installed in Marine Vessels: Technologies and Specifications. *Advances in Power Electronics*. Available online: <http://dx.doi.org/10.1155/2013/831560> (accessed on 14 July 2020). 1037
1038
76. Istrian Regional Energy Agency. Photovoltaic systems. Available online: http://www.irena-istra.hr/uploads/media/Photovoltaic_systems.pdf (accessed on 17 September 2020). 1039
1040
77. International Renewable Energy Agency. End-Of-Life Management: Solar Photovoltaic Panels. Available online: https://www.irena.org/documentdownloads/publications/irena_ieapvps_end-of-life_solar_pv_panels_2016.pdf (accessed on 14 July 2020). 1041
1042
1043
78. Prefersolar. Crystalline PV Panel. Available online: http://www.lslight.com/images/Alpsx_SolarPanels_240_255.pdf (accessed on 21 September 2020). 1044
1045
79. Zaninović, K.; Gajić-Čapka, M.; Perčec Tadić, M. Climate atlas of Croatia 1961-1990., 1971-2000. Croatian Meteorological and Hydrological Service, Zagreb, Croatia, 2008. 1046
1047
80. European Commission. Energy prices and costs in Europe, Annex 3. Available online: https://ec.europa.eu/energy/sites/ener/files/documents/annex_3_-_country_sheets_-_part_4_of_4_post_isc-v2.pdf (accessed on 07 November 2019). 1048
1049
81. Astaneh, M.; Dufo-López, R.; Roshandel, R.; Bernal-Agustin, J.L. A novel lifetime prediction method for lithium-ion batteries in the case of stand-alone renewable energy systems. *Electrical Power and Energy Systems* **2018**, *103*, 115–126. 1050
1051
82. Jianyun, Z.; Li, C.; Lijuan, X.; Bin, W. Bi-objective optimal design of plug-in hybrid electric propulsion system for ships. *Energy* **2019**, *177*, 247-261. 1052
1053
1054

ARTICLE 5

Preprint of the published journal article.

Techno-economic assessment of alternative marine fuels for inland shipping in Croatia

Maja Perčić¹, Nikola Vladimir^{*1}, Ailong Fan²

¹University of Zagreb, Faculty of Mechanical Engineering and Naval Architecture, Ivana Lučića 5, 10002 Zagreb, Croatia

²School of Energy and Power Engineering, Wuhan University of Technology, Wuhan, China

Abstract

Emissions reduction targets are pushing the shipping industry towards cleaner and more energy-efficient solutions. One option proposed is to replace conventional marine fuels with cleaner fuels. This is particularly important for vessels engaged in short-sea shipping and inland waterway transportation because their exhaust gases more negatively affect the local population than long-distance ships do. Hence the aim of this study is to undertake a technical, environmental and economic analysis of alternative fuels to reduce the environmental footprint and lifetime costs of inland waterway transportation. The analysis will focus on Croatia whose existing outdated inland waterway fleet needs to meet the goals of the Low-Carbon Development Strategy of the Republic of Croatia. In the study, a life-cycle analysis and life-cycle cost assessment of different alternative fuels will be performed taking into account the operating profiles and technical characteristics of vessels working in Croatia. The potential effects of a carbon tax are also examined in a case study considering carbon emissions reduction targets in Croatia by 2030. The electrification of ships is highlighted as the most environmentally friendly option for each considered ship, reaching a carbon emission reduction of up to 51%, while the most cost-effective option varies for each ship.

Keywords: inland waterways; carbon emissions; carbon tax; alternative fuels; life-cycle analysis

Word Count: 8592

* Corresponding author, e-mail: nikola.vladimir@fsb.hr

Nomenclature

Variables

<i>AC</i>	annual exploitation costs (€)
<i>B</i>	breadth (m)
<i>BC</i>	battery capacity (kWh)
<i>CA</i>	carbon allowance (€/t CO ₂)
<i>DWT</i>	deadweight (t)
<i>E</i>	emission (kg)
<i>EC</i>	energy consumption (kWh/km)
<i>EF</i>	emission factor (g emission/kg)
<i>FC</i>	fuel consumption (kg/km)
<i>IC</i>	investment cost (€)
<i>L</i>	length overall (m)
<i>l</i>	length of one-way trip (km)
<i>LCCCC</i>	life-cycle carbon credit cost (€)
<i>LCFC</i>	life-cycle fuel cost (€)
<i>LM</i>	lifetime mileage (km)
<i>N</i>	number of round trips (-)
<i>n</i>	time of a ship lifetime (year)
<i>NCV</i>	net calorific value (kWh/kg)
<i>NPV</i>	net present value (€)
<i>P</i>	Power (kW)
<i>PR</i>	price (€)
<i>r</i>	discount rate (%)
<i>SFC</i>	specific fuel consumption (kg/kWh)
<i>t</i>	operational time (h)
<i>TE</i>	tailpipe emission (g emission/kg)
<i>x</i>	share of a fuel (%)

Greek letters

η	efficiency
ρ	density (kg/l)

Abbreviations

<i>AM</i>	Ammonia-powered vessel
<i>BD</i>	B20-powered vessel
<i>CF</i>	Carbon Footprint
<i>CP</i>	Current policies
<i>D</i>	Diesel-powered vessel
<i>E</i>	Electric-powered vessel
<i>GHG</i>	Greenhouse Gas
<i>GWP</i>	Global Warming Potential
<i>H</i>	Hydrogen-powered vessel
<i>LCA</i>	Life-Cycle Assessment
<i>LCCA</i>	Life-Cycle Cost Assessment
<i>LNG</i>	Liquefied natural gas
<i>M</i>	Methanol-powered vessel
<i>NT</i>	Non-taxation
<i>PEM</i>	Proton Exchange Membrane
<i>PTW</i>	Pump-To-Wake
<i>RES</i>	Renewable Energy Source
<i>SD</i>	Sustainable Development
<i>SP</i>	Stated policies
<i>WTP</i>	Well-To-Pump
<i>WTW</i>	Well-to-Wake

Subscripts

<i>A</i>	annual
<i>AE</i>	auxiliary engine
<i>AM</i>	ammonia-powered vessel
<i>ave</i>	average
<i>CR</i>	cracker
<i>D</i>	diesel-powered vessel
<i>E</i>	electric-powered vessel
<i>f</i>	fuel used in a power system
<i>FC</i>	fuel cell
<i>H</i>	hydrogen-powered vessel
<i>i</i>	emission
<i>LNG</i>	LNG-powered vessel
<i>M</i>	methanol-powered vessel
<i>ME</i>	main engine
<i>n</i>	year of a ship lifetime
<i>ot</i>	one-way trip
<i>P-f</i>	pilot fuel mixed with fuel f
<i>P-LNG</i>	pilot fuel in LNG-powered vessel
<i>P-M</i>	pilot fuel in the methanol-powered vessel
<i>PR</i>	purifier

1. Introduction

The exhaust gas released by fossil fuel combustion negatively affects the environment, and is comprised of sulphur oxides (SO_x), nitrogen oxides (NO_x), carbon monoxide (CO), particulate matter (PM), but also Greenhouse Gases (GHGs), whose increased concentration in the atmosphere causes global warming [1]. These latter emissions relate to the emissions of carbon dioxide (CO₂), methane (CH₄), nitrous oxide (N₂O) and fluorinated gases in very low concentrations [2]. In the international shipping sector, about 70% of total emissions occur within 400 km of land, which impairs the air quality of coastal areas [3]. Current research into air pollution caused by the shipping sector mainly focuses on seagoing vessels and less on inland waterway vessels whose impact, however, is not negligible, since inland navigation vessels operate along the waterways and directly impair the air quality of the nearby population [4].

Inland waterway transport represents a mode of transport where passengers and freight are transported by vessels via inland waterways (canals, rivers, lakes, etc.) [5]. In contrast to rail and road transport, inland waterway transport offers a sustainable and environmentally friendlier mode of transport, especially in terms of energy consumption, noise and gas emissions. It is also considered the most cost-effective mode of transport due to low infrastructure and external costs [6]. In terms of safety, inland navigation is at least 50 times safer than road transport [7]. However, some issues that could affect the operation of an inland waterway vessel are limited waterway widths, fluctuations in water level [8] and the effects of the river current [9]. In terms of sustainability, inland waterway transport has an advantage over road transport, e.g. inland waterway transport has lower operational emissions per transported unit. However, this advantage is decreasing since road transport is slowly adapting to environmental trends and implementing alternative options for emission reductions, at least more quickly than the inland waterway sector. In Europe, road transportation is the main mode of land transport with a market share of approximately 76%, while the rest of the market share is divided between railways (18%) and inland waterways (6%) [10]. According to the European Commission, by 2050 the GHG emissions from transport will need to be at least 60% lower than in 1990. Within the European Strategy for Low-Emission Mobility, three priority areas for action are identified: increasing the efficiency of the transport system and encouraging a shift towards transport modes with lower emissions, the use of alternative energy with an emphasis on electrification, and a transition towards zero-emission vehicles [11]. The shift of freight

traffic from roads to inland waterways would result in a decrease in road congestion [12], but the negative environmental impact of inland navigation would rise, especially in terms of atmospheric pollution and the impairment of air quality and human health [13] [14].

Since global warming is a major concern and given the existence of many national strategies to reduce transport emissions, which are in accordance with the most relevant climate agreement that promotes a reduction of GHGs, i.e. the Paris Agreement signed in 2016 [15], this paper focuses only on GHG emissions. The contribution to global warming from different GHGs is evaluated with the Global Warming Potential (GWP) which is expressed as the appropriate CO₂ equivalent (CO₂-eq) [16]. In order to quantify the impact of CO₂ emissions, the term Carbon Footprint (CF) is used, denoting the total amount of CO₂ emissions over the product lifetime [17] expressed in tons of CO₂-eq.

The decarbonization of the shipping sector can be achieved through technical and operational measures [18] [19]. One of the technical measures relates to the replacement of conventional fossil fuel with alternative and cleaner fuel with lower carbon content which would reduce the CF of a ship power system [20]. The most frequently used alternative fuel in the shipping sector is Liquefied Natural Gas (LNG), whose application results in lower operating costs and emissions, but the investment costs, the required infrastructure and safety issues are major limitations of its wider use as a marine fuel [21]. Fan et al. [22] investigated its application in inland navigation ships. In their study, environmental and economic assessments indicated that using LNG in a hybrid power system results in lower overall emissions and costs.

Another fossil fuel that has been studied as a potential marine fuel is methanol, whose viability greatly depends on the area of navigation, the fuel price and the capital cost. The performed Life-Cycle Assessment (LCA) indicated that the total CF of fossil methanol is higher than the CF of conventional fuels, due to the larger amount of GHGs released from the LCA stages of fuel production and distribution [23]. A more viable option is to use renewable methanol (biomethanol) which has a lower environmental footprint [24]. However, as indicated by Helgason et al. [25] in their economic assessment of fossil and renewable methanol compared to heavy fuel oil, renewable methanol is expensive, and its application in the shipping sector will only be possible with subsidies. Biofuels, also called green fuels, are produced from renewable sources (waste, vegetable oil or plant biomass). According to environmental comparison of alternative marine fuels, Gilbert et al. [26] highlight biofuels as an ecological option with a CF reduction of 57%-79% compared to conventional marine fuels.

The full electrification of ships is an attractive decarbonization solution. For this type of electrification, a battery is used as energy storage due to its high energy density and low cost compared to other energy storages [27]. This kind of alternative option provides zero-emission shipping, i.e. ship operation without tailpipe emissions. However, an environmental impact analysis of a fully electric ship needs to be performed from the life-cycle point of view, since the emissions released during the electricity production process contribute to atmospheric pollution. The emissions also depend on the electricity mix used in the process [28]. Gagatsi et al. [29] investigated a fully electrified ferry from the point of view of sustainability and cost-effectiveness. Limitations such as battery capacity and sailing distance, but also the high investment costs, still represent obstacles in the wide deployment of battery-powered ships. One of the incentives for shipowners to electrify their ships is the introduction of carbon allowances in the shipping industry. If this happens, shipowners will have to pay a kind of carbon tax for each ton of CO₂ that is released into the atmosphere [30] [31].

The possible application of carbon allowances could also open the way for the use of hydrogen as an alternative marine fuel for use in a fuel cell. However, one of the obstacles to its wider application is hydrogen storage, although it is possible for hydrogen to be produced onboard from hydrogen carriers (i.e. natural gas, methanol, ethanol, ammonia, etc.) [32], [33].

The implementation of alternative fuels in the shipping sector depends on multiple factors, i.e. fuel reserves, available infrastructure, emissions produced, etc. Prussi et al. [34] investigated these factors and found a lack of reliable infrastructure for the use of methanol, hydrogen and electricity as shipping fuel and that the future fuel mix would depend on the potential for reductions in GHGs, technology improvement, and the availability and cost-effectiveness of such alternative solutions. The cost-effectiveness of a power system can be thoroughly investigated by performing a Life-Cycle Cost Assessment (LCCA), which is used in an economic analysis of a ship power system. For example, the comparison of an LCA and LCCA of different alternative fuels for onboard short-sea shipping vessels in a study by Perčić et al. [35] showed that a fully electric ship was the most cost-effective and most environmentally friendly option among those considered. Although they did not analyse electricity as a marine fuel, Nair and Acciaro [36] investigated six fuels for use in the shipping sector and concluded that LNG, besides satisfying environmental regulations in terms of reducing GHGs, represents a profitable investment since the price of the fuel is low. However, the viability of alternative fuels depends on the fleet type, technical performance, total costs, environmental impact, and exploitation. In addition, the application of alternative fuels should also be investigated for the geographical area of navigation.

Based on the above overview, a gap in the literature is evident: research into alternative fuels to reduce the CF is mainly directed at the long-distance and short-sea shipping sectors, while the possibility of their application in the inland waterway sector has not been adequately investigated. Alternative fuels are particularly important for Croatian inland shipping which consists mainly of outdated vessels with low energy-efficient power systems that need to meet emission reduction targets. Therefore, this paper presents a techno-economic assessment of alternative fuels (electricity, methanol, LNG, hydrogen, ammonia and biodiesel) to reduce the CF of Croatian inland waterways, where three ships are used as test cases. This paper provides a model to calculate the CF of different inland waterway vessels, identifies a set of alternative fuels that can be used in Croatian inland waterways, and, by performing an LCA and LCCA, highlights the most economical and ecological power system configuration.

2. Methodology

2.1. The Croatian inland waterway sector

According to the International Energy Agency, a major contributor to total CO₂ emissions in Croatia is the transport sector with a share of 40% in 2018 [37]. In transport emissions, road transport causes 96.4% of total transport CO₂ emissions, while navigation (which includes both seagoing and inland waterway vessels) generates 2.4% [38], Fig. 1.

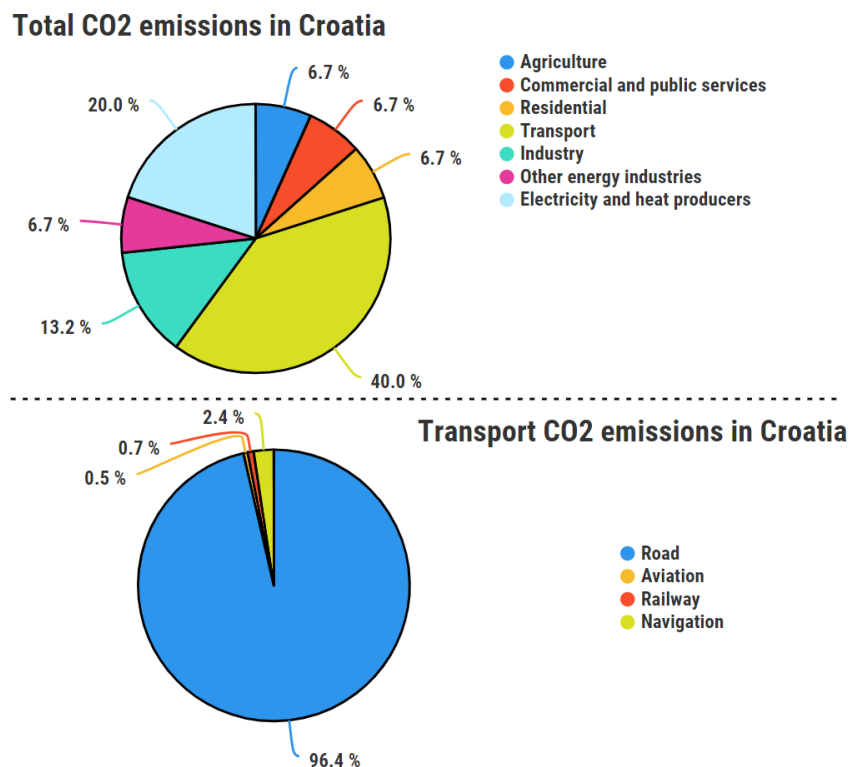

Fig. 1. Croatian total CO₂ emissions [37] and transport CO₂ emissions [38] in 2018

Even though the Croatian inland waterway sector contributes a small share to overall national CO₂ emissions, the national Low-Carbon Development Strategy requires a reduction in GHGs under certain sectoral policies which also apply to the inland waterway sector. Measures for the transport sector include the use of low-carbon fuels, optimizing and increasing the energy efficiency of transportation modes, and promoting the sustainable integrated transportation of passengers and freight, i.e. shifting from road to railway and inland waterway transportation [39].

The Croatian inland waterway network consists of the natural streams of the Danube, Sava, Drava, and Kupa, with a total length of 787.1 km. Even though it is geographically well placed, due to varying navigation conditions, technical obsolescence, and low capacity, Croatia's inland waterways are underutilized [40]. Some Croatian inland waterway vessels operate on lakes, which mainly belong to protected areas of nature and serve primarily for touristic purposes. The Croatian inland waterway fleet includes several types of ships: dredgers, tugboats (tugs and pushers), passenger ships and cargo ships. All vessels use high-speed four-stroke diesel engines (diesel-mechanical propulsion) [41]. The average age of these ships is around 40 years, which indicates that, in the near future, they will need to be replaced by new ships or at least retrofitted with a new power system. Even though their total emissions are much lower than those generated by marine vessels, their effect on the population in the settlements they pass through is not negligible. Taking into account the relevant national strategy on reducing GHGs, which requires particular measures in the transport sector, the opportunity arises to replace conventional diesel with alternative fuels.

This study divides the Croatian inland waterway fleet into three groups: cargo ships, passenger ships, and working ships (dredgers and tugboats). For each group, a representative has been selected, Fig. 2, and their particulars are presented in Table 1 [41].



Fig. 2. Analysed inland waterway vessels [42], [43], [44]

Table 1 Particulars of the selected ships

	Cargo ship	Passenger ship	Dredger
Length overall, L (m)	75.9	13.2	68.94
Breadth, B (m)	9.0	4.12	9.30
Deadweight, DWT (t)	967	15.72	484.6
Main engine(s) maximum continuous rating, P_{ME} (kW)	855	236	804
Auxiliary engine(s) maximum continuous rating, P_{AE} (kW)	100	-	476
Total power installed, P (kW)	955	236	1,280
Route length, l (km)	223	5	-
Annual number of trips, N_A	20	2,190	-

The representative of cargo ships is the tanker “Opatovac”, which is mostly used to transport oil between two Croatian refineries (Slavonski Brod and Sisak). Besides other factors, the ship speed depends on the direction of navigation (upstream or downstream). The average speed of a cargo ship of this size is 14.4 km/h, with an average main engine load of 75% of the maximum continuous rating [45]. With an average speed of the Sava River of 1 m/s [46], the average duration of the trip is 20.5 h for the upstream and 12.5 h for the downstream trip, respectively. The average load of the auxiliary engines is assumed to be 50% of the maximum continuous rating. The representative of passenger ships is the “Trošenj”, which operates in Krka National Park and usually sails between the Skradin and Skradinski Buk ports. The river speed is negligible. The duration of a one-way trip is 20 minutes, while the average speed is 15 km/h [43]. It is assumed that the ship operates at 70% of the total installed power.

Since the cargo and passenger ships have a particular route on which they sail, the energy consumption, EC (kWh/km), per distance travelled is calculated as follows:

$$EC = \frac{P_{ME,ave} \cdot t_{ot}}{l} + \frac{P_{AE,ave} \cdot t_{ot}}{l}, \quad (1)$$

where t_{ot} (h) represents the duration one-way trip. This general equation can be applied both to an upstream and downstream trip. The fuel consumption per distance travelled of a diesel-powered ship, FC (kg/km), is calculated by multiplying EC with the specific fuel consumption, SFC (g/kWh), with the following equation:

$$FC = EC \cdot SFC. \quad (2)$$

For high-speed diesel engines, SFC_D is equal to 215 g/kWh [47]. Assuming a ship lifetime of 20 years, the calculation of the lifetime mileage, LM (km), is performed as follows:

$$LM = 20 \cdot N_A \cdot 2 \cdot l. \quad (3)$$

However, equations (2) and (3) cannot be used for the representative of working ships since it does not have a specific route of navigation. The primary task of the dredger “Papuk” is to arrange the riverbed. Using data on the annual fuel consumption of this ship, FC_A (l),

which amounts to 63,023 litres and is reported by the shipowner, and with the assumption that the average load of the ship power system is 50% of the rated load, it is possible to approximately determine the time that the dredger spends in operation annually, t_A (h), using the following equation:

$$t_A = \frac{FC_A \cdot \rho}{0.5 \cdot P \cdot SFC_D}, \quad (4)$$

where ρ denotes the fuel density (kg/l) and P (kW) denotes the total installed power of the vessel. The annual energy consumption of the dredger, EC_A (kWh), can then be calculated according to the following equation:

$$EC_A = 0.5 \cdot P \cdot t_A. \quad (5)$$

The data for further analysis are calculated and presented in Table 2. For the cargo ship and passenger ship, the data are calculated by equations (1)-(3) and are expressed per km of the travelled trip, while for the ship without a particular route, i.e. the dredger, the annual data are calculated according to equations (4) and (5).

Table 2 Calculated data for the selected ships

Ship with a particular route		
	Cargo ship	Passenger ship
Average duration of a one-way trip, t_{ot} (h)	33	0.33
Average energy consumption, EC (kWh/km)	51.13	11.00
Average fuel consumption, FC_D (kg/km)	11.0	2.36
Lifetime mileage, LM (km)	178,400	438,000
Ship without a particular route		
	Dredger	
Annual operational time, t_A (h)	387	
Average annual energy consumption, EC_A (kWh)	247,695	
Lifetime (years)	20	

The combustion of fuel in marine engines results in tailpipe emissions, which are calculated by multiplying FC with the emission factors, EF (g emission/kg fuel), according to the following equation:

$$TE_i = FC \cdot EF_i, \quad (6)$$

where the subscript i refers to any emissions. This is a general equation whose principle is implemented on each considered power-system configuration.

2.2. Life-cycle assessment

2.2.1. General considerations on a life-cycle assessment

The most environmentally friendly alternative ship power system is one with the lowest environmental impact. One of the preferred methods for environmental impact analysis is the LCA which takes into account the emissions released throughout the life cycle of a product, involving several life stages [48].

LCA is performed by means of GREET 2019 software [49], which enables investigation of emissions released from the processes in the Well-to-Pump (WTP) phase (i.e. raw material recovery, production of the fuel and its transportation to the pump) and those released from the processes in the Well-to-Wake (WTW) phase, i.e. the WTP phase and the process of product use, known as the Pump-to-Wake (PTW) phase. PTW emissions refer to the tailpipe emissions. In order to analyse the CF of the entire power system configuration, besides WTW emissions, the emissions released from the manufacturing of its key elements are taken into account. In this study, the total GHGs released during the life-cycle of different ship power systems are expressed in CO₂-eq and calculated as follows:

$$CF = GWP_{CO_2} \cdot E_{CO_2} + GWP_{CH_4} \cdot E_{CH_4} + GWP_{N_2O} \cdot E_{N_2O}, \quad (7)$$

where E_{CO_2} , E_{CH_4} and E_{N_2O} refer to the total emissions of CO₂, CH₄ and N₂O released during the ship lifetime. Among the considered marine fuels, diesel, LNG and methanol result in tailpipe emissions. The emission factors for diesel and natural gas are obtained from [50], while the emission factor for methanol is obtained from [51], Table 3.

Table 3 Emission factors

GHG	GWP	Emission factors, EF (g/kg fuel)		
		Diesel	LNG	Methanol
CO ₂	1	3,206	2,750	1,380
CH ₄	25	0.06	51.2	-
N ₂ O	298	0.15	0.11	-

The system boundary is set on the power system, where the inputs refer to the total energy sources used in the observed life-cycle of a power system configuration, while the output represents the emissions associated with these life-cycle stages. Since the emphasis is on comparing power systems, under consideration here are only emissions related to the power system configurations, and not the ship hull and other ship systems, are considered.

2.2.2. The life-cycle assessment of a diesel-powered vessel

Analysis of the currently used diesel power system configuration represents a baseline to compare different alternative power options for the Croatian inland waterway fleet. It includes emissions released from processes of the WTP phase (crude oil recovery and its transportation to the refinery, refining, and its transportation to the oil pump) and the PTW phase (diesel combustion in an engine), Fig. 3.

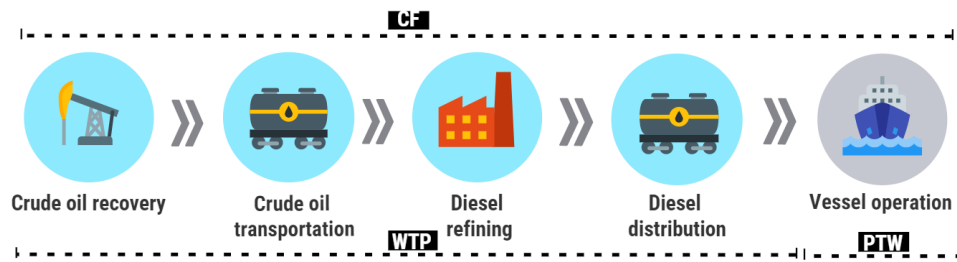

Fig. 3. Processes of the LCA of a diesel-powered vessel

The diesel used by the Croatian shipping sector corresponds to conventional diesel from the GREET 2019 database. Crude oil used for Croatian diesel production is primarily imported from the Middle East since domestic crude oil production is not sufficient for Croatian demand. The process of crude oil transportation involves transport by tank trucks from the exploitation site to the port (500 km), where the crude oil is loaded onto a tanker, which sails for 4,000 km to the Croatian terminal [52]. After the production of diesel, it is transported to the pump by tank trucks. This distance for the cargo ship is 200 km (from Rijeka to Sisak), for the passenger ship it is 300 km (from Rijeka to Šibenik) and for the dredger, it is 450 km (from Rijeka to Osijek).

The emissions released from the PTW phase is calculated according to equation (6). The *EFs* are presented in Table 3.

2.2.3. The life-cycle assessment of an electric-powered vessel

In recent years, fully electric ships have attracted great attention. The power system of these ships consists only of a battery as a power source, which leads to reduced emissions.

Even though it is expensive, a lithium-ion (Li-ion) battery has the highest energy density compared to other types of batteries, and has been widely investigated for shipping purposes [53]. The considered Li-ion battery has energy density values of 0.15-0.22 kWh/kg [54]. The battery capacity, *BC* (kWh), is defined depending on the operating requirements. It is assumed that for the cargo ship it is sufficient for a one-way trip with an average speed of 14.4 km/h. The battery installed onboard the passenger ship is recharged after a round trip, while the

battery used on the dredger has sufficient capacity to provide 8 hours of operation. For safety reasons, the required capacities are increased by 20% and determined by eq. (8) (for the cargo ship and the passenger ship) and eq. (9) (for the dredger):

$$BC = 1.2 \cdot EC \cdot (2) \cdot l, \quad (8)$$

$$BC = \frac{1.2 \cdot EC_A}{t_A} \cdot 8. \quad (9)$$

The LCA of an electric-powered ship includes electricity generation and the process of battery manufacturing, Fig. 4. During its operation, the vessel does not release exhaust gases. Hence, it produces zero PTW emissions.

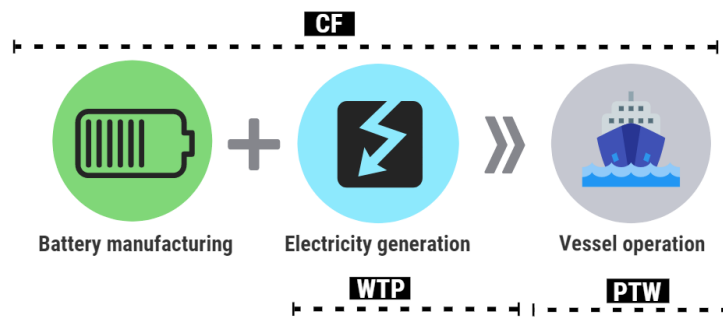

Fig. 4. Processes of the LCA of an electric-powered vessel

The WTP phase of electricity refers to the process of electricity generation. The structure of the Croatian electricity mix is shown in Fig. 5 [55].

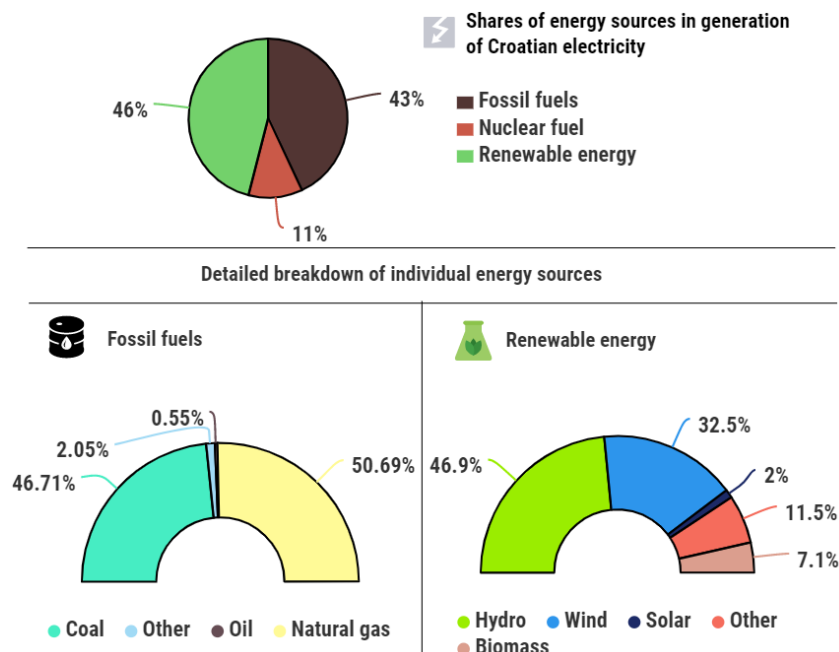

Fig. 5. Croatian electricity mix in 2018 [55]

The environmental impact of a battery is assessed taking into account the manufacturing process using data from the software database. The only required input is the battery weight which is calculated by dividing its capacity by its specific energy (0.22 kWh/kg). Replacement of the battery after ten years is also assumed.

2.2.4. The life-cycle assessment of a methanol-powered vessel

The second option to replace diesel fuel is methanol: a toxic, corrosive, but sulphur-free and biodegradable fuel. The main raw material for its production is natural gas and, due to the low carbon content, it has been attracting wide attention. Its similarity to marine fuels (due to its liquid state) allows for methanol to be used in the current diesel infrastructure with only minor modifications [56]. It can be easily used in the commercially available MAN dual-fuel engine, which uses a small amount of pilot fuel to initiate combustion [57]. In this paper, the considered vessels operate only in a dual-fuel mode with 95% of methanol and 5% of diesel (pilot fuel). The power output of the dual-fuel engine needs to be sufficient to cover the total installed power. Specific fuel consumptions refer to a load of 75% [58], Table 4.

Table 4 Dual-fuel engine for the considered vessels

	Cargo	Passenger	Dredger
Dual-fuel engine type	MAN G50ME-C9.6-LGIM		
Engine power (kW)	955	236	1,280
Specific consumption of methanol (SFC_M), g/kWh	327.2		
Specific consumption of pilot fuel (SFC_{P-M}), g/kWh	10.1		

The fuel consumptions in a dual-fuel engine can be calculated as follows:

$$FC_f = x_f \cdot EC \cdot SFC_f, \quad (10)$$

$$FC_{P-f} = x_{P-f} \cdot EC \cdot SFC_{P-f}, \quad (11)$$

where FC_f and FC_{P-f} refer to the consumption of the main fuel and pilot fuel, while x_f and x_{P-f} represent the proportions of the main fuel and pilot fuel in a dual-fuel engine, respectively. This general equation can be applied to each power system configuration which includes a dual-fuel engine.

The processes included in the LCA of a methanol-powered vessel refer to the WTP phase of methanol, the WTP phase of diesel from section 2.2.2, and combustion in a dual-fuel engine in the PTW phase, Fig. 6.

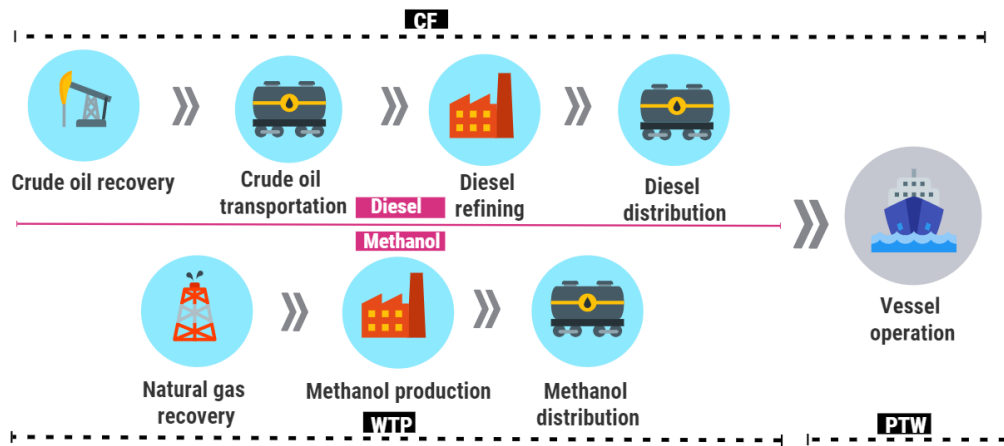

Fig. 6. Processes of the LCA of a methanol-powered vessel

The WTP phase of methanol includes the processes of natural gas recovery, the production of methanol and its transportation to the pump. It is assumed that methanol is made from natural gas by steam reforming and is produced in the Egyptian methanol plant from which it is transported via tanker to Croatia (3,000 km) [59]. Once the methanol is shipped to Croatia, it is transported via tank truck to pumps.

In the dual-fuel engine, both methanol and diesel as a pilot fuel are combusted and the released emissions are calculated according to equation (6). The *EFs* are presented in Table 3.

2.2.5. The life-cycle assessment of an LNG-powered vessel

As an affordable, non-toxic and non-corrosive fuel with lower carbon content than diesel, natural gas is competitive on the energy market for use as an alternative shipping fuel [60]. As in the case of a methanol-powered vessel, natural gas is usually used in a dual-fuel diesel engine that provides high efficiency and offers a smooth switch between one fuel and the other during ship operation without loss of power or speed [61]. Natural gas is originally in gaseous form. To make the handling process easier, natural gas is liquefied by cooling it at $-163\text{ }^{\circ}\text{C}$. In this way, LNG has 600 times less volume than in its gaseous state [62]. This study investigates the use of LNG in the Croatian inland waterway sector. It is used in a dual-fuel engine with diesel as a pilot fuel in a proportion of 1%. For a load of 75%, the specific consumption of LNG (SFC_{LNG}) is 154.4 g/kWh , while the specific consumption of pilot fuel (SFC_{P-LNG}) is 1.8 g/kWh [63]. The fuel consumption of LNG (FC_{LNG}) and pilot fuel (FC_{P-LNG}) is calculated according to equations (10) and (11).

The LCA of an LNG-powered vessel includes the processes related to the diesel part of the configuration (from section 2.2.2), those related to LNG, and the ship operation during which PTW emissions are released, Fig. 7.

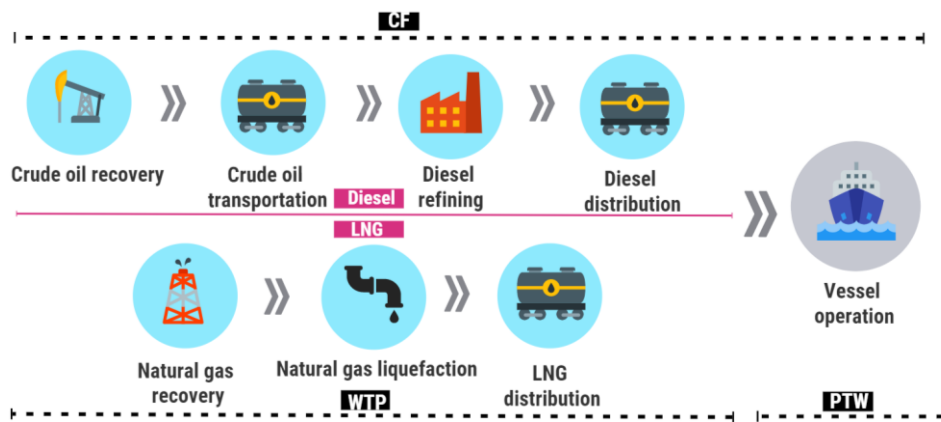

Fig. 7. Processes of the LCA of an LNG-powered vessel

The WTP phase encompasses the processes of natural gas recovery, its liquefaction and transportation. It is assumed that LNG is transported from Qatar via LNG carriers that transport it around 7,000 km to Croatia. Further transportation is made by tank truck for distances that correspond to the distances for diesel transportation (section 2.2.2).

In the dual-fuel engine, both LNG and diesel as a pilot fuel are combusted and the released emissions are calculated according to equation (6). The *EFs* are presented in Table 3.

2.2.6. The life-cycle assessment of a hydrogen-powered vessel

Hydrogen is an abundant and non-toxic fuel that is rarely found in pure form. It is usually produced from natural gas, but can also be obtained from biomass and by electrolysis [64]. Hydrogen is usually used in a fuel cell, which enables direct conversion of the chemical energy of fuel into electric energy via electrochemical reactions. Although the literature regularly considers the application of fuel cells only as an auxiliary power source, here, for comparative purposes, its use for ship propulsion is considered. Once the hydrogen is supplied to the ship, it is fed to a Proton Exchange Membrane (PEM) fuel cell. The characteristics of this type of fuel cell are its low operating temperature (65-85°C) and, given its intolerance to impurities, its requirement for pure hydrogen as fuel [65]. With an efficiency of 48% (η_{FC}) [66], the selected PEM fuel cells have power equal to the total installed power of the existing vessels. Considering the *EC* of a vessel, the net calorific value of hydrogen (NCV_H) which is equal to 33.3 kWh/kg, and η_{FC} , the hydrogen consumption, (FC_H) can be calculated:

$$FC_H = \frac{EC}{\eta_{FC} \cdot NCV_H}. \quad (12)$$

The LCA of a hydrogen-powered vessel includes the manufacturing process of a fuel cell, natural gas recovery, hydrogen production and its liquefaction, its distribution by tank trucks, and vessel operation during which there are no tailpipe emissions, Fig. 8.

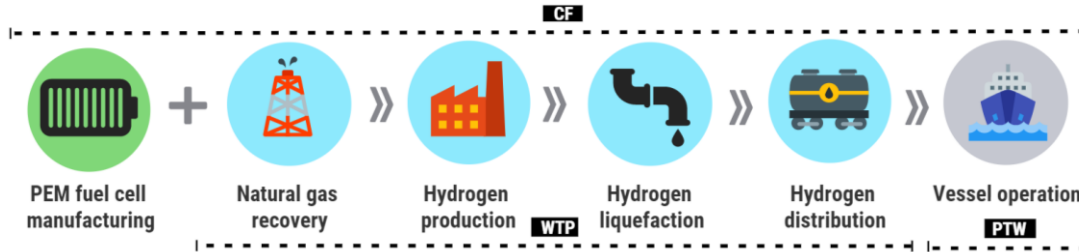

Fig. 8. Processes of the LCA of a hydrogen-powered vessel

The considered hydrogen is produced from natural gas in Western Europe and, after its production and liquefaction, it is transported to Croatia by tank trucks (distances: cargo ship: 1,200 km; passenger ship: 1,300 km; dredger: 1,450 km). The weights of materials used in the PEM fuel cell are taken from [67] and further used as an input for GREET 2019. Replacement of the fuel cells after 10 years is also assumed.

2.2.7. The life-cycle of an ammonia-powered vessel

Ammonia is a hydrogen-rich fuel. It is mostly produced through the Haber-Bosch process, where nitrogen from the air and hydrogen are combined at high temperature and pressure. A well-established infrastructure and the lack of carbon content in ammonia make it a promising option for the shipping sector [68] [69].

In this paper, ammonia is considered as a hydrogen carrier. The ammonia needs to be processed through a cracker, where the decomposition of ammonia into hydrogen and nitrogen occurs, and then the hydrogen is passed through a purifier to ensure that only purified hydrogen enters into the fuel cell [70]. While the particulars for the PEM fuel cell correspond to those in section 2.2.6, the fuel consumption of ammonia (FC_{AM}) is calculated as follows:

$$FC_{AM} = \frac{EC}{\eta_{CR} \cdot \eta_{PR} \cdot \eta_{FC} \cdot NCV_{AM}}. \quad (13)$$

where η_{CR} and η_{PR} refer to the efficiency cracker (80%) and purifier (90%) [70], while the NCV_{AM} refers to the net calorific value of ammonia which is equal to 5.17 kWh/kg [64].

The LCA of an ammonia-powered vessel includes the manufacturing process of a fuel cell, natural gas recovery, ammonia production and its distribution by tank trucks, Fig. 9. There are no tailpipe emissions while the ship is operating.

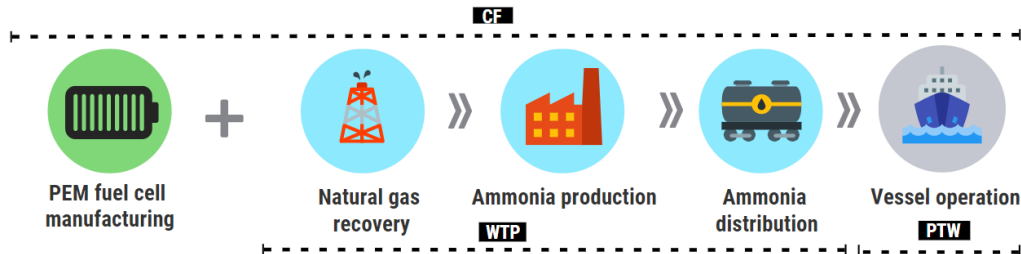

Fig. 9. Processes of the LCA of an ammonia-powered vessel

Ammonia is considered to be produced on the same site as the hydrogen, where it is distributed in the same manner as the hydrogen. The environmental impact of a fuel cell is the same as the calculated for the hydrogen-powered ship.

2.2.8. The life-cycle assessment of a B20-powered vessel

In recent years, biofuels have also been attracting interest. The most commonly produced biofuel is biodiesel whose feedstock can be classified into four main groups: edible vegetable oil (sunflower, soybean, rapeseed etc), non-edible vegetable oil (algae, cottonseed, jojoba etc.), recycled and waste oil, and animal fat [71]. Biodiesel is usually used as a blend with fossil fuels, and is designated as BXX, where XX indicates the biodiesel percentage in a blend. The blend usually used as a transportation fuel contains a low share of biodiesel [72].

This study considers the soybean biodiesel-diesel blend B20 in which Croatian diesel is used (section 2.2.2), while the soybean biodiesel is imported from the Veneto region of Italy [73]. The WTP phase of the biodiesel consists of several processes: soybean farming and soy oil extraction, soy oil transportation by tank trucks (50 km) to the transesterification plant. The produced biodiesel is then transported to a refuelling station where it is assumed that the biodiesel and diesel are mixed into a B20 blend. Transportation distances are different for each considered vessel: 450 km (cargo ship), 550 km (passenger ship) and 700 km (dredger). The performed LCA of a B20-powered vessel includes the processes presented in Fig. 10.

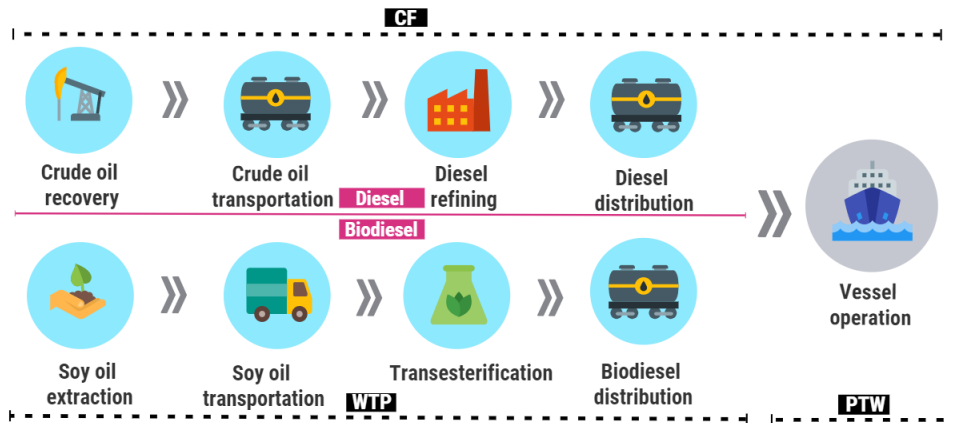

Fig. 10. Processes of the LCA of a B20-powered vessel

Given the general opinion that biofuels are considered carbon-neutral fuels, biodiesel tailpipe CO₂ emissions are not included in total life-cycle emissions, while CH₄ and N₂O emissions are considered negligible [74]. The PTW emissions released by a B20-powered vessel consist of the emissions related only to the diesel and are calculated according to equation (6). The *EFs* are presented in Table 3.

2.3. Life-cycle cost assessment

2.3.1. General considerations on life-cycle cost assessment

LCCA considers the total costs of a power system configuration during the ship lifetime. These life-cycle costs refer to the investment cost and exploitation cost.

The investment cost represents the capital cost of the power system, the maintenance cost refers to the maintenance and equipment replacement cost, while the fuel cost relates to the life-cycle cost of a fuel that is used in the power system. The carbon credit cost refers to the cost of carbon allowance, which represents the right to emit 1 ton of CO₂ [30]. Even though the inland shipping sector has not yet implemented carbon credit, this paper investigates its implementation through different scenarios, as performed by Trivyza et al. [75]. The considered scenarios refer to the non-taxation (NT) scenario and three carbon credit scenarios: the Current Policies (CP) scenario considers the current policies implemented in the energy sector, without additional changes in the future; the Stated Policies (SP) scenario relates to current policies and today's policy targets; and the Sustainable Development (SD) scenario refers to the strategic pathway to meet global climate, air quality and energy access goals. The forecast carbon allowance, *CA* (€/t CO₂) and the values for 2030 and 2040 in the European Union for each

scenario are obtained from [76] and interpolated to obtain relevant trends. For 2020, the CA value is zero, since carbon credit has not yet been implemented, Fig. 11.

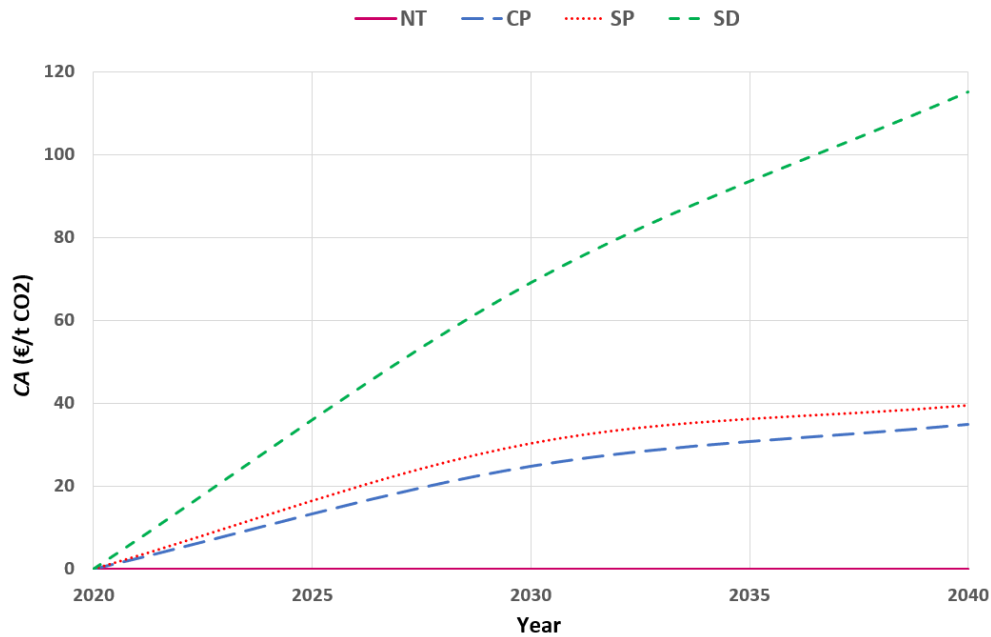

Fig. 11. Carbon allowance scenarios according to [76]; NT - non-taxation scenario, CP - current policies scenario, SP - stated policies scenario, SD - sustainable development scenario

The carbon credit cost is illustrated only for ship power systems that release PTW emissions. The life-cycle carbon credit cost, $LCCCC$ (€), for different scenarios yields:

$$LCCCC = \sum_{n=1}^{20} PTW_{A,n} \cdot CA_n, \quad (14)$$

where n refers to one year of the ship lifetime, $PTW_{A,n}$ denotes annual tailpipe emissions in t CO₂-eq, while CA_n refers to the carbon allowance for year n .

A proper cost comparison of different power system configurations can be achieved by reducing their total costs to the Net Present Value (NPV), a measure that discounts the future costs to the present value. The NPV of each power system is calculated as follows:

$$NPV = IC + \sum_{n=1}^{20} \frac{AC_n}{(1+r)^n}, \quad (15)$$

where IC (€) refers to the investment cost, AC_n (€) represents all annual costs in a year n (including the fuel cost, maintenance cost and carbon credit cost), r refers to the discount rate and n is the number of years, i.e. the lifetime of a ship.

2.3.2. The life-cycle cost assessment of a diesel-powered vessel

Since most Croatian inland waterway vessels are powered by outdated diesel engines, the purchase of a new diesel power system configuration is investigated. The investment cost of a diesel engine is calculated by multiplying the total installed power with the assumed conversion factor of 250 €/kW. The maintenance conversion factor of this power system is obtained from [77] and is 0.014 €/kWh. The life-cycle maintenance cost of the diesel power system of the cargo and the passenger ship is calculated by multiplying the conversion factor by EC and LM , while for the dredger the conversion factor is multiplied by FC_A and the lifetime of 20 years.

The life-cycle fuel cost ($LCFC_f$) of the cargo ship and the passenger ship is obtained by equation (16), while for the dredger these total fuel costs can be calculated using equation (17), where subscript f refers to any fuel used in the power system:

$$LCFC_f = LM \cdot FC_f \cdot PR_f, \quad (16)$$

$$LCFC_f = 20 \cdot FC_{A,f} \cdot PR_f. \quad (17)$$

The diesel price used in this assessment amounts to 0.78 €/kg [78]. The carbon credit cost is calculated according to equation (14).

2.3.3. The life-cycle cost assessment of an electric-powered vessel

A major obstacle in the electrification of the shipping sector is the high investment cost of an electric-powered vessel (IC_E). In this paper, it is calculated according to the equation below, where it is assumed that 45% of IC_E refers to the battery price, while the rest represents installation, electric engine and additional equipment costs [79]:

$$IC_E = \frac{BC \cdot PR_B}{0.45}, \quad (18)$$

where PR_B refers to the battery price which is assumed to be 200 €/kWh [80]. The maintenance cost relates only to the replacement of the battery after 10 years. According to Tsiropoulos et al. [80], the forecast Li-ion battery price for 2030 is 169 €/kWh.

The electricity price for a Croatian medium-sized enterprise is 0.078 €/kWh [78]. The life-cycle fuel cost of an electric-powered vessel can be calculated according to equations (16) and (17), where, instead of fuel consumption, energy consumption is considered.

2.3.4. The life-cycle cost assessment of a methanol-powered vessel

Conversion from a diesel power system configuration to a methanol power system configuration results in a cost of 750 €/kW for a new-build system which considers the purchase of a new engine and associated equipment [51]. It is assumed that the life-cycle maintenance cost of a methanol-powered ship is equal to the life-cycle maintenance cost of a diesel-powered ship. The life-cycle fuel cost of a methanol-powered vessel can be calculated with equations (16) and (17), where the FC and prices of both pilot fuel and methanol are considered. The methanol price amounts to 0.325 €/kg, which is calculated by increasing the price set by the producer, i.e. 0.26 €/kg with Croatian VAT of 25% [59]. The carbon credit costs are calculated according to eq. (14).

2.3.5. The life-cycle cost assessment of an LNG-powered vessel

The investment cost of a new-build LNG system is calculated by multiplying the conversion rate (which includes the engine and all additional equipment costs) of 1,160 €/kW [51] by the engine power, Table 4. The life-cycle maintenance cost is calculated as for the diesel-powered vessel, where the conversion factor is equal to 0.015 € [77].

The price for 1 kg of LNG in Europe varies from 0.95 € to 1.1 €. For this assessment, the LNG price is assumed to be 1.1 €/kg. The life-cycle fuel cost of a methanol-powered vessel can be calculated with equations (16) and (17), where the FC and prices of both pilot fuel and LNG are considered. The carbon credit for each power system configuration is calculated according to eq. (14).

2.3.6. The life-cycle cost assessment of a hydrogen-powered vessel

The investment cost of a hydrogen-powered vessel includes a PEM fuel cell (368 €/kW) [81], which is increased by 20% in order to take into account additionally required equipment, while the hydrogen storage cost is calculated by multiplying the amount of hydrogen required for ship operation by the NCV_H and liquid hydrogen storage price of 5 €/kWh. The required mass of hydrogen is increased by 20% for safety reasons [82]. The life-cycle maintenance cost refers only to the replacement once in the ship's lifetime of the fuel cell and is equal to its capital cost. The life-cycle fuel cost of a hydrogen-powered vessel can be calculated with equations (16) and (17), where the hydrogen price lies in the range of 5.35- 9.5 €/kg [83] [84]. For this assessment, the upper limit of the range is used in the assessment.

2.3.7. The life-cycle cost assessment of an ammonia-powered vessel

By considering the required cracker and purifier, the investment cost of an ammonia-powered vessel is calculated by increasing the PEM fuel cell cost by 30%. The life-cycle maintenance cost refers only to the replacement of the fuel cell once in the ship's lifetime and is equal to its capital cost.

The life-cycle fuel cost of an ammonia-powered vessel can be calculated with equations (16) and (17), where the price of ammonia is 0.7 €/kg [70].

2.3.8. The life-cycle cost assessment of a B20-powered vessel

The investment and the maintenance costs of a B20-powered vessel are equal to the investment and maintenance costs of a diesel-powered vessel. The price of pure biodiesel is assumed to be the same as the price of Croatian diesel (1.48 €/kg) [78]. The life-cycle fuel cost of a B20-powered vessel can be calculated with equations (16) and (17), where the FC and the prices of both biodiesel and diesel are considered.

The carbon credit for each power system configuration is calculated according to eq. (14).

2.4. Limitations and approximations

The limitations and approximations in this paper are listed as follows:

- The system boundary is fixed to the ship power systems, where the emissions and costs are related only to the ship power system, while the other units of the ship, i.e. the hull, additional equipment, crew, etc., are not taken into account given that they are considered to remain the same while the power is brought to the propeller. However, this approach is sufficiently accurate to identify technical solutions to reduce emissions generated by the power system. This is important since relevant regulations recognize the ship as a separate unit and evaluate its particular contribution.
- Since the cargo ship speed is approximated according to the ships of the same type and size (according to [45]) and has an impact on both emissions and costs, a relevant sensitivity study is included in the discussion section.

- Idealization of the fuel distribution processes and the transportation of the raw material to the production facility are one of the approximations in the paper. However, stationary processes generate most of the WTP emissions, and, therefore, a change in the distribution and transportation pathways would not have a major impact on the WTP emissions.
- Stationary processes of fuels within the WTP phase for all fuels are taken from the GREET 2019 database. For some fuels like biodiesel, this may cause some minor inaccuracies, bearing in mind the fact that this fuel is mainly produced from different feedstocks in the United States (soy and palm) and Europe (rapeseed, sunflower and palm). However, for biodiesel, the contribution of the stationary process to the total emission amounts is relatively small (particularly for biodiesel-diesel blend B20), and this assumption has practically no influence on the overall findings.
- The assumption about the investment cost of additional equipment for fuel cell system does not have a major influence on the final LCCA results since the investment cost of such a power system is relatively minor compared to other costs of that power system.
- An increase in fuel prices in the future is not considered, and therefore the cost assessments follow the business-as-usual scenario. The variability of hydrogen costs is presented in the sensitivity analysis within the discussion section.
- Other limitations of the paper may be that the cost assessment is performed without considering interest rates and that the study focuses only on the ship power system without considering the costs of the ship crew, port fees and other expenses.

3. Results

The LCA and LCCA results of the investigated vessels are presented in Fig. 12 where D denotes diesel, E denotes electricity, M refers to methanol, H refers to hydrogen, AM refers to ammonia, while BD refers to the biodiesel-diesel blend B20. In the LCCA, the SD scenario as a carbon credit implementation scenario is considered.

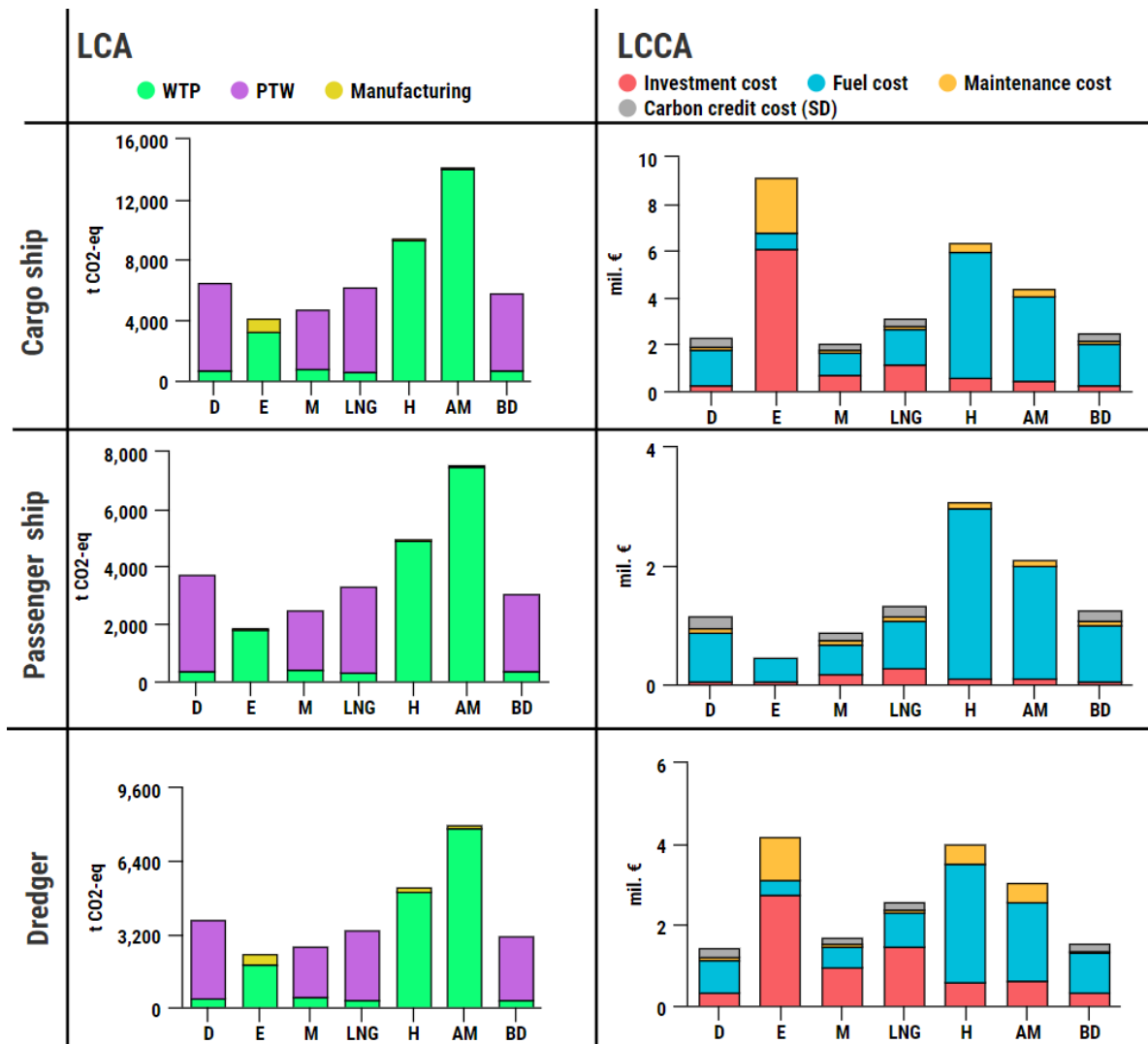

Fig. 12. A comparison of the LCA and LCCA of alternative fuels; D - diesel, E - electricity, M - methanol, LNG - liquefied natural gas, H - hydrogen, AM - ammonia, BD - biodiesel-diesel blend B20

An insight into the impact of individual costs on the total *NPV* of each power system, with an assumed discount rate of 5%, is performed and presented in Fig. 13. The analysis is performed using the example of the cargo ship.

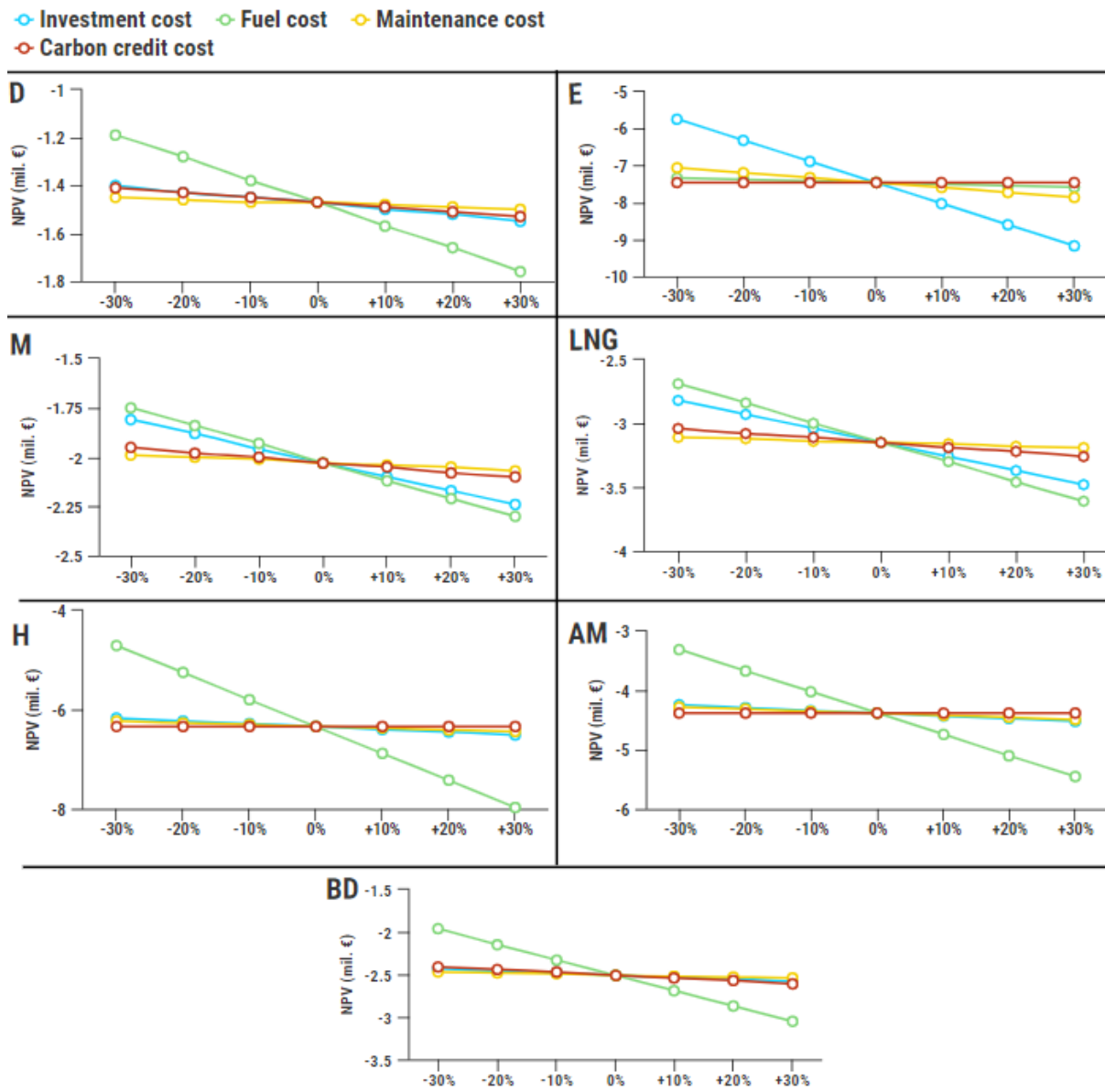

Fig. 13. Impact of individual costs on the *NPV* for different power systems; D - diesel, E - electricity, M - methanol, LNG - liquefied natural gas, H - hydrogen, AM - ammonia, BD - biodiesel-diesel blend B20

The obtained results are extensively discussed in the following section.

4. Discussion

A comparison of the LCA results shows that the most environmentally friendly decarbonisation solution, for each considered vessel, is an electric-powered vessel that involves replacing the diesel engine with a Li-ion battery. The application of this power system results

in a CF reduction of 36% for the cargo ship, 51% for the passenger ship and 40% for the dredger. The great difference between these percentages is mainly related to the required battery capacity as well as to the lifetime energy consumption of each vessel. This power system configuration does not release exhaust gas during operation, and its CF is constituted by the emissions related only to electricity generation and the manufacturing of the battery. The electricity mix used for electricity generation has a great effect on the WTP emissions, and an increased share of Renewable Energy Sources (RESs) in the mix would reduce these emissions. Three different scenarios with different electricity mixes are observed to describe the effect of the electricity power origin on the total WTP emissions of an electric-powered ship, where the passenger ship is taken as a test case, Fig. 14.

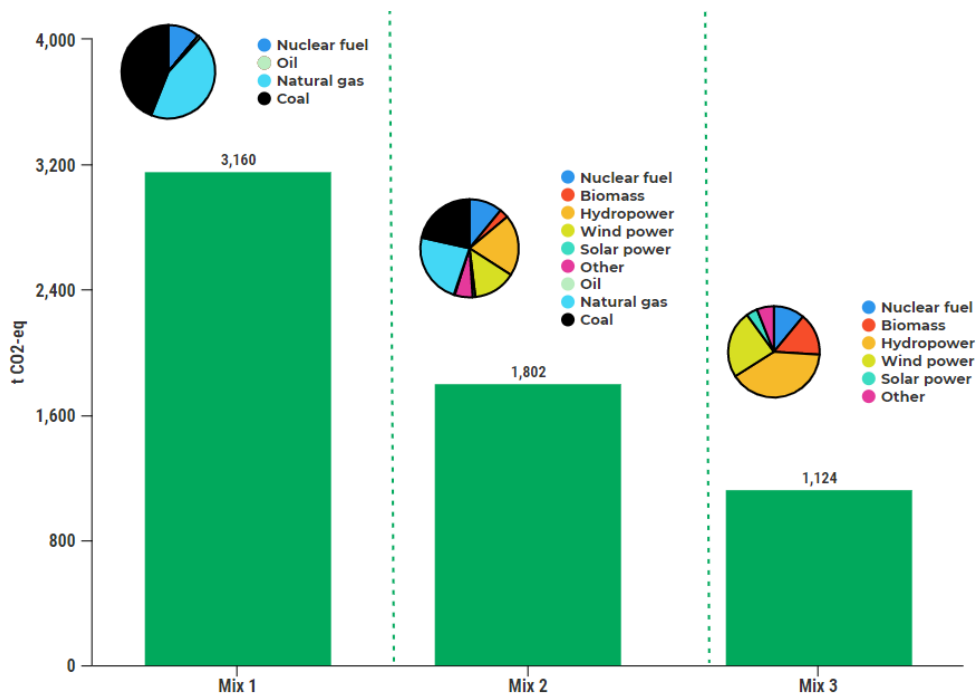

Fig. 14. The WTP emissions of an electric-powered passenger ship with different electricity mixes

Mix 2 refers to the Croatian mix used in this paper, Mix 1 is a mix of only fossil energy sources and nuclear energy, while Mix 3 represents an electricity mix with only RESs and nuclear energy. It is evident that Mix 3 results in the lowest total WTP emissions and that by increasing the share of RESs in the Croatian electricity mix, the emissions related to electrification would be lower.

Other alternative fuels that can be used in Croatian inland waterways and which have a lower CF than a diesel-powered vessel are methanol, LNG and B20. Methanol is indicated as the second most environmentally friendly option, and its application would result in a CF

reduction of 28% (for the cargo ship), 33% (for the passenger ship) and 30% (for the dredger). The reason for this is the lower emission factors, Table 3. The ammonia-powered vessel is the ship power system with the highest CF among those investigated in this study. The main reason is the use of fossil ammonia (produced from natural gas) which is required in great amounts due to losses in the cracker and purifier. Applying other fuel cells which tolerate impurities, hence allowing fuel to enter the fuel cell without a precleaning process, would lower the WTP emissions of the ammonia-powered vessel. Using hydrogen onboard inland waterway vessels would result in high emissions. Even though one of the benefits of this configuration is that there are no tailpipe emissions, the WTP emissions are not negligible, and they constitute most of the CF.

The performed LCCAs resulted in revealing the most cost-effective power option for each ship. This option for the cargo ship is a methanol-power system, while for the dredger the power option with the lowest total costs is diesel power. However, following environmental trends, diesel-powered vessels will need to be replaced with some power system that has a lower CF compared to the currently used power system and which does not involve high total costs. This kind of option is hence a methanol-powered system. Due to the required battery capacity, and consequently the high investment cost of battery and hydrogen, an electric-powered vessel and a hydrogen-powered vessel are rather expensive for use in cargo ships and dredgers engaged in the Croatian inland waterway fleet.

Bearing in mind that the target hydrogen price is below 3 €/kg [85], four different hydrogen prices are observed in the analysis where the passenger ship is taken as a test case, Fig. 15.

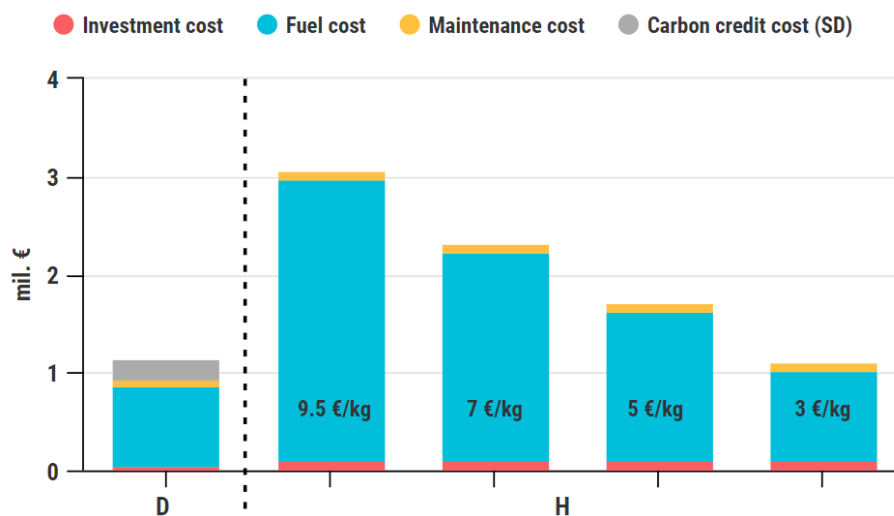

Fig. 15. Sensitivity analysis of the hydrogen price on the total costs of the hydrogen-powered passenger vessel; D - diesel, H - hydrogen

The analysis shows that a hydrogen-powered vessel has lower costs than a diesel-powered vessel only when the price of hydrogen drops to 3 €/kg. Then, the cost of such a configuration is 4% less than the cost of an existing passenger ship. By using green hydrogen, i.e. hydrogen produced from RESs, and with a target fuel price, hydrogen will be a very good alternative solution for replacing the diesel power system configuration. However, in this paper, the LCCA results for the passenger ship indicate an electric-powered vessel as the most economical solution. The total life-cycle costs of this configuration are around 60% lower than the costs of the current power system installed on the considered vessels. It needs to be emphasized that the passenger ship has the longest operating time among the considered vessels, and it requires autonomy of approximately one hour. The calculated payback period is within 3 years.

For the considered cargo ship, a sensitivity analysis of the effect of speed on the life-cycle emissions and the life-cycle costs of different power system configurations was performed. The speed varies by $\pm 30\%$, with a step increment of 10%. With a change of speed, the average power also changes. Since ship power is roughly proportional to the cube of its speed, the average ship power for different speeds is calculated. As presented in Fig. 16, the increase and decrease of speed have a great effect on total emissions. For example, a 20% increase in speed raises emissions by 44%, while a 10% decrease emissions by 19%.

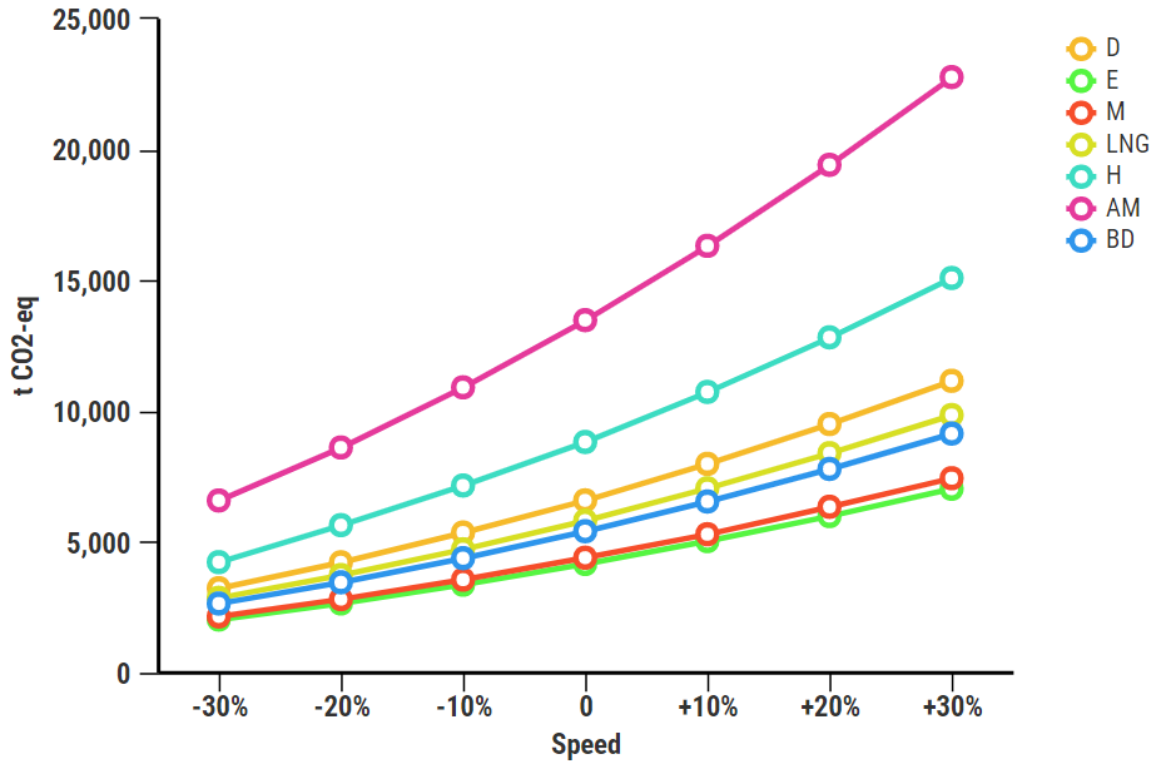

Fig. 16. Impact of ship speed on the life-cycle emissions of different power systems; D - diesel, E - electricity, M - methanol, LNG - liquefied natural gas, H - hydrogen, AM - ammonia, BD - biodiesel-diesel blend B20

The impact of speed variations on the *NPV* of an individual ship power system is presented in Fig. 17, where an assumed discount rate is also set at 5%.

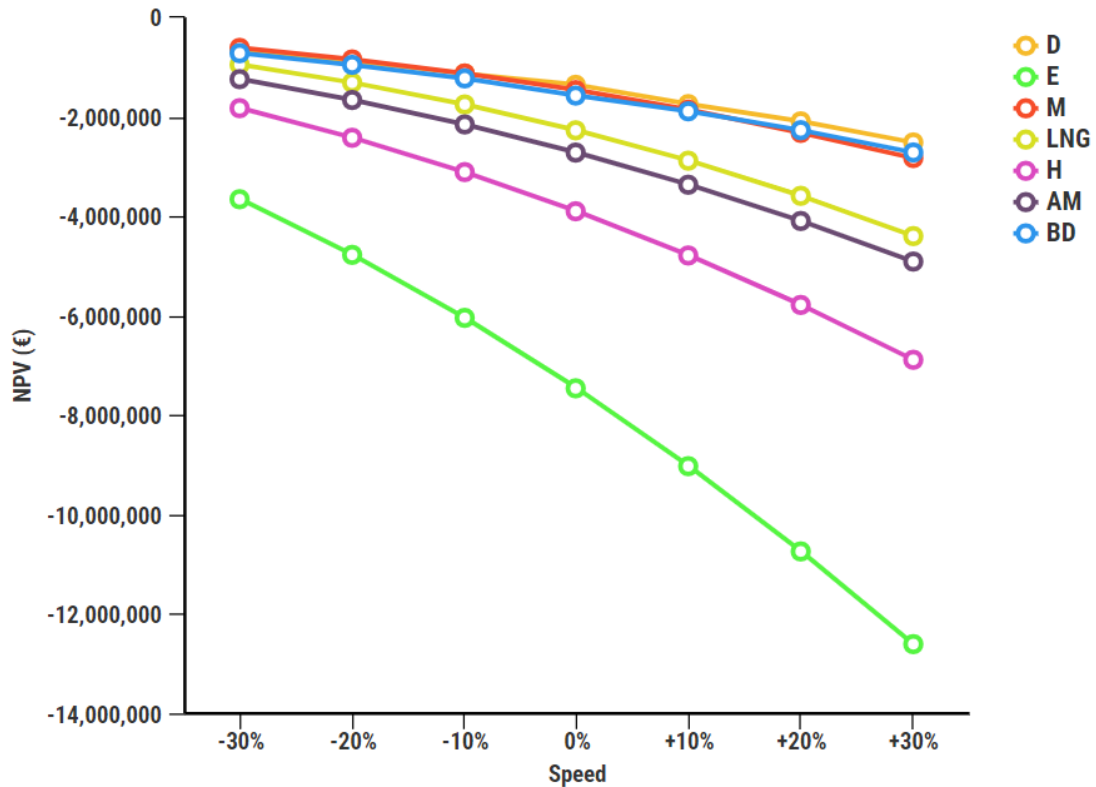

Fig. 17. Impact of ship speed on the *NPV* for different power systems; D - diesel, E - electricity, M - methanol, LNG - liquefied natural gas, H - hydrogen, AM - ammonia, BD - biodiesel-diesel blend B20

According to Fig. 17, an electric power system would be the most expensive solution for the cargo ship. However, by reducing the speed by 30%, the *NPV* of the electric-powered ship is reduced by 51%, while for the methanol-powered ship it is reduced by 56%. The main reason for this difference is the great investment cost of the electric-powered ship which is not discounted since it is an initial cost that occurs in year zero.

The analysis reveals that for most of the power systems, the cost of fuel has a major effect on the *NPV* and that by reducing the fuel costs, that is, with a fall in the price of fuel, the costs of the power system configurations become more acceptable. However, this does not refer to the electric-powered ship since the price of electricity is already low, while the investment cost is a major contributor to the total *NPV* of a system.

The sensitivity analysis indicates that the use of alternative fuels is more feasible when the speed is reduced, and when the total costs of alternative power systems are lower and therefore more acceptable to shipowners.

5. Conclusion

The decarbonisation of ship power systems through the use of alternative fuels is investigated in order to comply with ever stringent environmental regulations on the reduction of GHGs. The applicability of five alternative fuels (electricity, methanol, LNG, hydrogen, ammonia and biodiesel) is illustrated using the example of three different vessels belonging to the Croatian inland waterway fleet: a cargo ship, a passenger ship, and a dredger. The main conclusions of this research are:

- The LCA indicates that the most environmentally friendly option is an electric-powered vessel. This power system configuration results in a lower CF compared to the diesel power system configuration. The biggest CF reduction is achieved for the passenger ship, which amounts to 51%, while the cargo ship and the dredger achieved a CF reduction of 36% and 40%.
- The most cost-effective alternative is the one with the lowest total lifetime cost, which is a methanol power system configuration for the cargo ship. The LCCA highlighted that full electrification represents the most economical solution for the passenger ship, while for the dredger, the most economical option is still the diesel power system configuration.
- Even though methanol is shown as the most economical alternative fuel for the cargo ship, this study indicates that further development of the bunkering infrastructure and distribution chains of methanol are required. Since, for the dredger, the existing power system is the most cost-effective solution, one of the options is to replace diesel with methanol, leading to a power system that is only 15% more expensive than the existing one. Besides the required appropriate battery charger in ports, Li-ion battery technology is well known and commercially available, while the electricity for charging the battery is Croatian electricity. Therefore, an electric-powered ship is the most suitable option for the passenger ship.

Further investigation will focus on different hybrid power systems that can be applied in the Croatian inland waterway sector, taking into account more advanced solutions of a ship's power system, especially those with a high share of RESs. Their application, which depends on energy efficiency, i.e. environmental performance and cost-effectiveness, will be assessed with optimization methods.

Finally, it should be mentioned that although this model has been applied in the case of Croatia, it is generally applicable to other inland waterways if a relevant set of ship technical

data, information on operating conditions, and insights into particular energy mixes of the considered country is available.

Acknowledgements

This research was supported by the Croatian Science Foundation under the project Green Modular Passenger Vessel for Mediterranean (GRiMM), (Project No. UIP-2017-05-1253) as well as within the Croatian-Chinese bilateral project “Energy efficient and environmentally friendly power system options for inland green ships” conducted by the University of Zagreb, Faculty of Mechanical Engineering and Naval Architecture (Croatia), and Wuhan University of Technology (China). Maja Perčić, a Ph.D. student, is supported through the “Young researchers' career development project – training of doctoral students” of the Croatian Science Foundation, funded by the European Union from the European Social Fund.

The LCA analysis in this study was performed using GREET 2019 software produced by UChicago Argonne, LLC under Contract No. DE-AC02-06CH11357 with the Department of Energy.

Literature

- [1] Monteiro A, Russo M, Gama C, Borrego C. How important are maritime emissions for the air quality: At European and national scale. *Environmental Pollution* 2018; 242 (Part A): 565-575.
- [2] United Nations Framework Convention Climate Change. Climate Change Information kit, <https://unfccc.int/resource/iuckit/cckit2001en.pdf>; 2001 [accessed 10 July 2020].
- [3] Toscano D, Murena F. Atmospheric ship emissions in ports: A review. Correlation with data of ship traffic. *Atmospheric Environment: X* 2019; 4: 100050.
- [4] Keuken MP, Moerman M, Jonkers J, Hulskotte J, Denier van der Gon HAC, Hoek G, Sokhi RS. Impact of inland shipping emissions on elemental carbon concentrations near waterways in the Netherlands. *Atmospheric Environment* 2014; 95: 1-9.
- [5] Wiegman B, Witte P, Spit T. Inland port performance: a statistical analysis of Dutch inland ports. *Transportation Research Procedia* 2015; 8: 145-154.
- [6] United Nations Economic Commission for Europe (UNECE). Efficient and sustainable inland water transport in Europe,

- <https://www.unece.org/fileadmin/DAM/trans/doc/2011/sc3wp3/ECE-TRANS-SC3-189e.pdf>; 2011 [accessed 26 November 2020].
- [7] United Nations. Transport Trends and Economics Series, Transport for Sustainable Development: The case of Inland Transport, https://www.unece.org/fileadmin/DAM/trans/publications/Transport_for_Sustainable_Development_UNECE_2015.pdf; 2015 [accessed 25 November 2020].
- [8] Christodoulou A, Christidis P, Bisselink B. Forecasting the impacts of climate change on inland waterways. *Transportation Research Part D: Transport and Environment* 2020; 82: 102159.
- [9] Xing S, Xinpig Y, Bing W, Xin S. Analysis of the operational energy efficiency for inland river ships. *Transportation Research Part D: Transport and Environment* 2013; 22: 34-39.
- [10] Sys C, Van de Voorde E, Vanelslender T, van Hassel E. Pathways for a sustainable future inland water transport: A case study for the European inland navigation sector. *Case Studies on Transport Policy* 2020; 8: 686–699.
- [11] European Commission. Transport emissions. A European Strategy for low-emission mobility, https://ec.europa.eu/clima/policies/transport_en; 2020 [accessed 25 November 2020].
- [12] European Commission. Inland waterway, https://ec.europa.eu/transport/modes/inland_en; 2020 [accessed 12 July 2020].
- [13] Cao Y-L, Wang X, Yin C-Q, Xu W-W, Shi W, Qian G-R, Xun Z-M. Inland Vessels Emission Inventory and the emission characteristics of the Beijing-Hangzhou Grand Canal in Jiangsu province. *Process Safety and Environmental Protection*, 2018; 113: 498-506.
- [14] van der Zee SC, Dijkema MBA, van der Laan J, Hoek G. The impact of inland ships and recreational boats on measured NO_x and ultrafine particle concentrations along the waterways. *Atmospheric Environment* 2012; 55: 368-376.
- [15] Bataille C, Åhman M, Neuhoff K, Nilsson LJ, Fishedick M, Lechtenböhmer S, Solano-Rodriguez B, Denis-Ryan A, Steiber S, Waisman H, Sartor O, Rahbar S. A review of technology and policy deep decarbonization pathway options for making energy-intensive industry production consistent with the Paris Agreement. *Journal of Cleaner Production* 2018; 187: 960-973.
- [16] Environmental Protection Agency. Understanding the Global Warming Potentials, <https://www.epa.gov/ghgemissions/understanding-global-warming-potentials>; 2020 [accessed 10 July 2020].
- [17] Wiedmann T, Minx J. A Definition of Carbon Footprint. In: Pertsova CC, *Ecological Economics Research Trends: Chapter 1*. Nova Science Publishers, Hauppauge NY; 2008, 1-11.
- [18] Bouman EA, Lindstad E, Riialand AI, Strømman AH. State-of-the-art technologies, measures, and potential for reducing GHG emissions from shipping - A review. *Transportation Research Part D: Transport and Environment* 2017; 52: 408-421.
- [19] Xing H, Spence S, Chen H. A comprehensive review on countermeasures for CO₂ emissions from ships. *Renewable and Sustainable Energy Reviews* 2020; 134: 110222

- [20] Hansson J, Månsson S, Brynolf S, Grahn M. Alternative marine fuels: Prospects based on multi-criteria decision analysis involving Swedish stakeholders. *Biomass and Bioenergy* 2019; 126, 159-173.
- [21] Livanos GA, Theotokatos G, Pagonis D-N. Techno-economic investigation of alternative propulsion plants for Ferries and RoRo ships. *Energy Conversion and Management* 2014; 79: 640–651.
- [22] Fan A, Wang J, He J, Perčić M, Vladimir N, Yang L. Decarbonising inland ship power system: Alternative solution and assessment method. *Energy* 2021; 226: 120266.
- [23] International Maritime Organization. Methanol as marine fuel: Environmental benefits, technology readiness, and economic feasibility, <http://www.imo.org/fr/OurWork/Environment/PollutionPrevention/AirPollution/Documents/Report%20Methanol%2021.01.2016.pdf>; 2016 [accessed 30 June 2020].
- [24] Svanberg M, Ellis J, Lundgren J, Landälv I. Renewable methanol as a fuel for the shipping industry. *Renewable and Sustainable Energy Reviews* 2016; 94: 1217–1228.
- [25] Helgason R, Cook D, Davíðsdóttir B. An evaluation of the cost-competitiveness of maritime fuels – a comparison of heavy fuel oil and methanol (renewable and natural gas) in Iceland. *Sustainable Production and Consumption* 2020; 23: 236–248.
- [26] Gilbert P, Walsh C, Traut M, Kesieme U, Pazouki K, Murphy. Assessment of full life-cycle air emissions of alternative shipping fuels. *Journal of Cleaner Production* 2018; 172: 855-866.
- [27] Nuchturee C, Li T, Xia H. Energy efficiency of integrated electric propulsion for ships – A review. *Renewable and Sustainable Energy Reviews* 2020; 134: 110145.
- [28] Perčić M, Ančić I, Vladimir N. Life-cycle cost assessments of different power system configurations to reduce the carbon footprint in the Croatian short-sea shipping sector. *Renewable and Sustainable Energy Reviews* 2020; 131:110028.
- [29] Gagatsi E, Estrup T, Halatsis A. Exploring the potentials of electrical waterborne transport in Europe: the E-ferry concept. *Transportation Research Procedia* 2016; 14: 1571-1580.
- [30] EU Emissions Trading System. Carbon allowance, https://ec.europa.eu/clima/policies/ets_en; 2020 [accessed 09 July 2020].
- [31] Trapp AC, Harris I, Sanchez Rodrigues V, Sarkis J. Maritime container shipping: Does cooperation improve cost and environmental efficiencies? *Transportation Research Part D* 2020; 87: 102507.
- [32] van Biert L, Godjevac M, Visser K, Aravind PV. A review of fuel cell systems for maritime applications. *Journal of Power Sources* 2016; 327: 345-364.
- [33] Abdin Z, Zafaranloo A, Rafiee A, Mérida W, Lipiński W, Khalilpour KR. Hydrogen as an energy vector. *Renewable and Sustainable Energy Reviews* 2020; 120: 109620.
- [34] Prussi M, Scarlat N, Acciaro M, Kosmas V. Potential and limiting factors in the use of alternative fuels in the European maritime sector. *Journal of Cleaner Production* 2021; 291: 125849.

- [35] Perčić M, Vladimir N, Fan A. Life-cycle cost assessment of alternative marine fuels to reduce the carbon footprint in short-sea shipping: A case study of Croatia. *Applied Energy* 2020; 279: 115848.
- [36] Nair A and Acciaro M. Alternative fuels for shipping: optimising fleet composition under environmental and economic constraint. *International Journal of Transport Economics* 2018; XLV.
- [37] International Energy Agency. Croatia, CO₂ emissions by sector, <https://www.iea.org/countries/croatia>; 2020 [accessed 30 November 2020].
- [38] Ministry of environment and energy, Republic of Croatia. Croatian greenhouse gas inventory for the period 1990 – 2018 (National Inventory Report 2020), http://www.haop.hr/sites/default/files/uploads/dokumenti/012_klima/dostava_podataka/Izvjesca/NIR_2020_eng.pdf; 2020 [accessed 30 November 2020].
- [39] Ministry of Economy and Sustainable Development, Republic of Croatia. Low-Carbon Development Strategy of the Republic of Croatia until 2030 with an outlook to 2050, <https://mzoe.gov.hr/o-ministarstvu-1065/djelokrug-4925/klima/strategije-planovi-i-programi-1915/strategija-niskouglijicnog-razvoja-hrvatske/1930>; 2020 [accessed 01 December 2020].
- [40] Ministry of the Sea, Transport and Infrastructure of the Republic of Croatia. Inland navigation, <https://mmpi.gov.hr/more-86/unutarnja-plovidba-110/110>; 2020 [accessed 25 June 2020].
- [41] Croatian Register of Shipping. Register of inland waterway vessels. <http://www.crs.hr/Portals/0/Register%20of%20Inland%20Navigation%20Vessels.pdf>; 2019 [accessed 25 June 2020].
- [42] The cargo ship “Opatovac”. <https://www.marinetraffic.com/en/ais/details/ships/shipid:209454/mmsi:238401840/imo:0/vessel:OPATOVAC>; 2020 [accessed 07 November 2019].
- [43] National Park Krka. Passenger ship “Trošenj”. <http://www.npkrka.hr/stranice/izletibrodom/33.html>, <http://www.npkrka.hr/stranice/ulaz-skradin/30.html>; 2020 [accessed 26 June 2020].
- [44] Dredger “Papuk”. <http://www.hidrogradnja.hr/gallery/papuk/>; 2020 [accessed 09 July 2019].
- [45] van Essen HP, Faber J, Wit RCN. Charges for barges? Preliminary study of economic incentives to reduce engine emissions from inland shipping in Europe, Delft, CE; 2004.
- [46] Croatian Meteorological and Hydrological Service. Hydrology sector, <https://hidro.dhz.hr/>; 2020 [accessed 26 June 2020].
- [47] Ančić I, Vladimir N, Cho DS. Determining environmental pollution from ships using Index of Energy Efficiency and Environmental Eligibility (I4E). *Marine Policy* 2018; 95: 1-7.
- [48] International Organization for Standardization (ISO 14040). Life cycle assessment, <https://web.stanford.edu/class/cee214/Readings/ISOLCA.pdf>; 1997 [accessed 09 July 2020].
- [49] GREET. LCA software, <https://greet.es.anl.gov/>; 2020 (accessed 27 June 2020).
- [50] IMO. Third IMO GHG Study, Executive Summary and Final Report. <http://www.imo.org/en/OurWork/Environment/PollutionPrevention/AirPollution/Doc>

- uments/Third%20Greenhouse%20Gas%20Study/GHG3%20Executive%20Summary%20and%20Report.pdf; 2014 [accessed 18 March 2020].
- [51] Ellis J, Tanneberger K. Study on the use of ethyl and methyl alcohol as alternative fuels in shipping. Report prepared for the European Maritime Safety Agency (EMSA), 2015.
- [52] Croatian Energy Regulatory Agency. Annual Report, https://www.hera.hr/en/docs/HERA_Annual_Report_2018.pdf; 2018 [accessed 29 June 2020].
- [53] Zubi G, Dufo-López R, Carvalho M, Pasaoglu G. The lithium-ion battery: State of the art and future perspectives. *Renewable and Sustainable Energy Reviews* 2018; 89: 292-308.
- [54] Gandoman FH, Jaguemont J, Shovon Goutam S, Gopalakrishnan R, Firouz Y, Kalogiannis T, Omar N, Van Mierlo J. Concept of reliability and safety assessment of lithium-ion batteries in electric vehicles: Basics, progress, and challenges. *Applied Energy* 2019; 251: 113343.
- [55] HEP. Sources for Croatian electricity generation, <http://www.hep.hr/elektra/trziste-elektricne-energije/izvori-elektricne-energije/1553#>; 2020 [accessed 09 July 2020].
- [56] Ammar NR. An environmental and economic analysis of methanol fuel for a cellular container ship. *Transportation Research Part D: Transport and Environment* 2019; 69: 66-76.
- [57] MAN. The ME-LGI Engine and Methanol as a Marine Fuel, <https://marine.man-es.com/two-stroke/2-stroke-engines/me-lgim>; 2020 [accessed 30 June 2020].
- [58] MAN. Marine engine programme, https://www.man-es.com/docs/default-source/marine/4510_0017_02web.pdf?sfvrsn=4e9c62f7_12; 2019 [accessed 30 June 2020].
- [59] Methanex. Methanol, <https://www.methanex.com/about-methanol>; 2020 [accessed 30 June 2020].
- [60] Wan C, Yan X, Zhang D, Yang Z. A novel policy making aid model for the development of LNG fuelled ships. *Transportation Research Part A: Policy and Practice* 2019; 119: 29–44.
- [61] Wärtsilä,. Dual- fuel engines, <https://www.wartsila.com/encyclopedia/term/dual--fuel-engines-from-w%C3%A4rtsil%C3%A4>; 2020 [accessed 01 July 2020].
- [62] Ekanem Attah E, Bucknall R. An analysis of the energy efficiency of LNG ships powering options using the EEDI. *Ocean Engineering* 2015; 110: 62-74.
- [63] Wärtsilä, 34DF, product guide, https://www.wartsila.com/docs/default-source/product-files/engines/df-engine/product-guide-o-e-w34df.pdf?utm_source=engines&utm_medium=dfengines&utm_term=w34df&utm_content=productguide&utm_campaign=msleadscoring; 2019 [accessed 01 July 2020].
- [64] Bicer Y, Dincer I. Clean fuel options with hydrogen for sea transportation: A life cycle approach. *International Journal of Hydrogen Energy* 2018; 43: 1179-1193.
- [65] Inal BO, Deniz C. Assessment of fuel cell types for ships: Based on multi-criteria decision analysis. *Journal of Cleaner Production* 2020; 265: 121734.
- [66] Rivarolo M, Rattazi D, Lamberti T, Magistri L. Clean energy production by PEM fuel cells on tourist ships: A time-dependent analysis. *International Journal of Hydrogen Energy* 2020. <https://doi.org/10.1016/j.ijhydene.2019.12.086>.

- [67] Garraín D, Lechoń Y. Exploratory environmental impact assessment of the manufacturing and disposal stages of a new PEM fuel cell. *International Journal of Hydrogen Energy* 2014; 39 (4): 1769-1774.
- [68] Cha J, Jo YS, Jeong H, Han J, Nam SW, Song KH, Yoon CW. Ammonia as an efficient COX-free hydrogen carrier: Fundamentals and feasibility analyses for fuel cell applications. *Applied Energy* 2018; 224: 194–204.
- [69] Chisalita D-A, Petrescu L, Cormos C-C. Environmental evaluation of european ammonia production considering various hydrogen supply chains. *Renewable and Sustainable Energy Reviews* 2020; 130: 109964.
- [70] Kim K, Roh G, Kim W, Chu K. A Preliminary Study on an Alternative Ship Propulsion System Fueled by Ammonia: Environmental and Economic Assessments. *Journal of Marine Science and Engineering* 2020; 8(3): 183.
- [71] Mohd Noor CW, Noor MM, Mamat R. Biodiesel as alternative fuel for marine diesel engine applications: A review. *Renewable and Sustainable Energy Reviews* 2018; 94: 127–142.
- [72] Demirbas A. Progress and recent trends in biodiesel fuels. *Energy Conversion and Management* 2009; 50 (1): 14-34.
- [73] Buratti C, Barbanera M, Fantozzi F. A comparison of the European renewable energy directive default emission values with actual values from operating biodiesel facilities for sunflower, rape and soya oil seeds in Italy. *Biomass and Bioenergy* 2012; 47: 26-36.
- [74] Hammond GP, Seth SM. Carbon and environmental footprinting of global biofuel production. *Applied Energy* 2013; 112: 547-559.
- [75] Trivyza NL, Rentizelas A, Theotokatos G. Impact of carbon pricing on the cruise ship energy systems optimal configuration. *Energy* 2019; 175: 952-966.
- [76] International Energy Agency. *World Energy Outlook 2019*. <https://doi.org/10.1787/caf32f3b-en>.
- [77] Iannaccone T, Landucci G, Tugnoli A, Salzano E, Cozzani V. Sustainability of cruise ship fuel systems: Comparison among LNG and diesel technologies. *Journal of Cleaner Production* 2020; 260: 121069.
- [78] European Commission. *Energy prices and costs in Europe, Annex 3*, https://ec.europa.eu/energy/sites/ener/files/documents/annex_3_-_country_sheets_-_part_4_of_4_post_isc-v2.pdf; 2018 [accessed 07 July 2020].
- [79] Christos B. Techno-economical feasibility study on the retrofit of double-ended Ro/Pax ferries into battery-powered ones. Diploma thesis. National Technical University of Athens, School of Naval Architecture and Marine Engineering; 2017.
- [80] Tsiropoulos I, Tarvydas D, Lebedeva N. Li-ion batteries for mobility and stationary storage applications, JCR Science for Policy Report, European Commission. <http://publications.jrc.ec.europa.eu/repository/bitstream/JRC113360/kjna29440enn.pdf>; 2018 [accessed 07 July 2020].
- [81] Ghenai C, Bettayeb M, Brdjanin B, Hamid AK. Hybrid solar PV/PEM fuel Cell/Diesel Generator power system for cruise ship: A case study in Stockholm, Sweden. *Case Studies in Thermal Engineering* 2019; 14: 100497.

- [82] Niaz S, Manzoor T, Pandith AH. Hydrogen storage: Materials, methods and perspectives. *Renewable and Sustainable Energy Reviews* 2015; 50: 457–469.
- [83] Ma S, Lin M, Lin T-E, Lan T, Liao X, Maréchal F, Van Herle J, Yang Y, Dong C, Wang L. Fuel cell-battery hybrid systems for mobility and off-grid applications: A review. *Renewable and Sustainable Energy Reviews* 2021; 135: 110119.
- [84] European Commission. Fuel price comparison, <https://ec.europa.eu/transport/sites/transport/files/2017-01-fuel-price-comparison.pdf>; 2017 [accessed 15 July 2020].
- [85] International Renewable Energy Agency (IRENA). Hydrogen from renewable power: Technology outlook for the energy transition, https://www.irena.org/-/media/Files/IRENA/Agency/Publication/2018/Sep/IRENA_Hydrogen_from_renewable_power_2018.pdf; 2018 [accessed 06 May 2021].

ARTICLE 6

Preprint of the published journal article.

Application of fuel cells with zero-carbon fuels in short-sea shipping

Maja Perčić^{1*}, Nikola Vladimir¹, Ivana Jovanović¹, Marija Koričan¹

¹University of Zagreb, Faculty of Mechanical Engineering and Naval Architecture, Ivana Lučića 5, 10002 Zagreb, Croatia. * Corresponding author: maja.percic@fsb.hr

Abstract

This paper investigates the viability of different fuel cell types in a ship power system, where hydrogen and ammonia are considered as zero-carbon fuels. The identification of alternatives to diesel-powered ships is performed by taking into account the environmental and economic indicators of the considered power systems, determined by Life-Cycle Assessment (LCA) and Life-Cycle Cost Assessment (LCCA), and further compared with the existing diesel power systems of three passenger ships operating in Croatian coastal waters. Special attention is paid to fuel origin, where fossil fuels (grey fuel), fossil fuels followed by CO₂ capture (blue fuel), and those produced from renewable energy sources (green fuel) are considered. The results of the research indicate that fuel cell systems with grey hydrogen and grey ammonia are not environmentally friendly, while fuel cell systems with the blue and green types of these fuels have a lower impact on the environment than a diesel-powered ship, with a reduction of up to 84% in CO₂-eq emissions when green ammonia is used. Regarding profitability, the diesel-powered ship has the lowest total costs, while the second most cost-effective option is the fuel cell system with blue ammonia as fuel with 27%-43% higher costs than a diesel-powered ship, depending on which type of fuel cell is used. Although blue ammonia is a cheaper fuel than diesel fuel, the lifetime costs of the fuel cell power system are affected by relatively high investment costs (fuel cell, battery, cracker, etc.) and equipment replacement costs.

Keywords: short-sea shipping; fuel cell; ammonia; hydrogen; LCA; LCCA

Nomenclature

Variables

<i>AFP</i>	aerosol formation potential (t PM _{2,5} -eq)
<i>AP</i>	acidification potential (t SO ₂ -eq)
<i>BC</i>	battery capacity (kWh)
<i>CapEx</i>	capital costs (€)
<i>E</i>	emission (t)
<i>EC</i>	energy consumption (kWh/nm)
<i>EF</i>	emission factor (g emission/kg)
<i>EH</i>	energy for heating of a fuel cell system (kWh)
<i>FC</i>	fuel consumption (kg/nm)
<i>FED</i>	fossil energy demand (%)
<i>GWP</i>	global warming potential (t CO ₂ -eq)
<i>l</i>	length of one-way trip (nm)
<i>LM</i>	lifetime mileage (nm)
<i>LT</i>	lifetime (year)
<i>n</i>	time of a ship lifetime (year)
<i>N</i>	number of round trips (-)
<i>NCV</i>	net calorific value (kWh/kg)
<i>NPV</i>	net present value (€)
<i>OpEx</i>	operating costs (€)
<i>P</i>	power (kW)
<i>r</i>	discount rate (%)
<i>SFC</i>	specific fuel consumption (kg/kWh)
<i>t</i>	operational time (h)
<i>v</i>	speed (kn)

Greek letters

η	efficiency (-)
--------	----------------

Abbreviations

B-A	Blue ammonia
B-H	Blue hydrogen
CCS	Carbon Capture and Storage
ECA	Emission Control Area
DAFC	Direct Ammonia Fuel Cell
EEDI	Energy Efficiency Design Index
GH ₂	Gaseous hydrogen
GHG	Greenhouse gas
Gn-A	Green ammonia
Gn-H	Green hydrogen
Gy-A	Grey ammonia
Gy-H	Grey hydrogen
IMO	International Maritime Organization
KPI	Key Performance Indicator
LCA	Life-Cycle Assessment
LCCA	Life-Cycle Cost Assessment
LH ₂	Liquid hydrogen
M	Manufacturing phase
MCFC	Molten Carbonate
PEMFC	Proton Exchange Membrane Fuel Cell
PTW	Pump-to-Wake phase
RES	Renewable Energy Source
SD	Sustainable Development
SOFC	Solid Oxide Fuel Cell
WROS	World Register of Ships
WTP	Well-to-Pump phase

Subscripts

<i>A</i>	ammonia
<i>AE</i>	auxiliary engine
<i>An</i>	annual
<i>ave</i>	average
<i>B</i>	battery-powered ship
<i>C</i>	cracker
<i>CH₄</i>	emission of methane
<i>CO₂</i>	emission of carbon dioxide
<i>D</i>	diesel-powered ship
<i>de</i>	design
<i>f</i>	fuel used in a fuel cell
<i>FC</i>	fuel cell
<i>H</i>	hydrogen
<i>i</i>	any emission
<i>M, i</i>	emission <i>i</i> from M phase
<i>ME</i>	main engine
<i>NO_x</i>	emission of nitrogen oxides
<i>N₂O</i>	emission of nitrous oxide
<i>P</i>	purifier
<i>PEMFC-A</i>	PEMFC fueled with ammonia
<i>PM₁₀</i>	emission of particulate matter
<i>PEMFC-H</i>	PEMFC fueled with hydrogen
<i>PTW, i</i>	emission <i>i</i> from PTW phase
<i>SOFC-A</i>	SOFC fueled with ammonia
<i>SO_x</i>	emission of sulphur oxides
<i>SOFC-H</i>	SOFC fueled with hydrogen
<i>st</i>	start-up
<i>WTP, i</i>	emission <i>i</i> from WTP phase

1. Introduction

Fossil fuel combustion in a ship's internal combustion engine causes exhaust gas consisting of nitrogen oxides (NO_x), sulphur oxides (SO_x), carbon monoxide (CO), carbon dioxide (CO₂), particulate matter (PM), and hydrocarbons [1]. In order to control these emissions which negatively affect the environment and human health [2], the International Maritime Organization (IMO) within the International Convention for the Prevention of Pollution from Ships set regulations for the prevention of air pollution from ships, including the establishment of Emission Control Areas (ECAs) [3]. SO_x emissions are regulated by the limit of sulphur content in fuel, while the NO_x emission limit depends on the engine maximum operating speed. Both the SO_x and NO_x regulation standards differ depending on the area of navigation (global or ECA) [4]. CO₂ emissions are regulated by the Energy Efficiency Design Index (EEDI), which represents the ratio between the released amount of CO₂ emissions and the benefit for society [5].

CO₂ is the major Greenhouse Gas (GHG) and an increase in its concentration in the atmosphere causes global warming [6]. Within the scope of the Paris Agreement adopted in 2015 which advocates the reduction of GHGs [7], IMO set a goal of reducing GHG emissions from international shipping by 50% up to 2050 compared to the 2008 levels [8]. In the most recent GHG Study, [9], IMO reported that in 2018 the shipping sector generated 2.89% of global anthropogenic GHG emissions, while in 2012 this share was 2.76%. The study predicts that without proper and rigorous decarbonization measures, GHG emissions from shipping will rise [9]. GHG reduction measures and technologies are presented in studies by Bouman et al. [10] and Xing et. al. [11]. According to these authors, the replacement of a conventional power system with alternatives will lead to a significant reduction in shipping emissions. One alternative is electrification, where three different types of electrified ships can be identified: a fully electric ship, a plug-in hybrid ship, and a hybrid electric ship. These ships use a small or zero amount of fossil fuel, which results in lower maintenance costs, increased safety, and reduced noise and vibrations, leading to lower disruption of the marine ecosystem [12]. Due to the absence of exhaust gases, the most environmentally friendly type of electrification is full electrification [13]. One of the powering options is a rechargeable battery, where the Lithium-ion (Li-ion) battery is perhaps the most significant for the shipping industry, currently having the highest energy density among other commercial batteries [14]. Besides battery, fully electric propulsion can also be achieved by means of fuel cell technology onboard the ship

[15], which represents an important and viable solution for zero-carbon shipping [16]. While battery-powered ships exploiting current technology are nowadays suitable only for coastal navigation [13], fuel cell technology has the potential to be used on large and high-power ships that operate on the open seas [17]. With the further development of battery technology towards metal-air batteries with a much higher energy density and lifetime than the Li-ion battery [18], the full electrification of ships operating on longer routes using only a battery may be feasible.

A fuel cell is an electrochemical device that converts the chemical energy of fuel into electric energy. The basic elements of a fuel cell are a positive electrode (cathode), a negative electrode (anode) and an electrolyte. Fuel enters into the anode and an oxidant into the cathode. Due to the electrochemical reaction of oxidation and reduction, a gradient of chemical potential is developed, resulting in electricity in the external electrical circuit [19]. Different fuel cell types are available, and they are primarily classified by their operating temperature and by the electrolyte used, i.e. their names reflect the materials used in the electrolyte. Based on the operating temperature, fuel cells can be classified into three groups: low-temperature fuel cells ($\sim 80^{\circ}\text{C}$), intermediate-temperature fuel cells ($\sim 200^{\circ}\text{C}$), and high-temperature fuel cells (650°C - 1000°C) [20].

Hydrogen is an ideal fuel for a fuel cell, due to its fast kinetics of electrochemical reactions and the absence of exhaust gases, where the only by-product of the reaction is water [21]. Based on cleanliness and the type of energy used for its production, hydrogen can be classified into three types: grey, blue, and green hydrogen. Grey hydrogen is produced from fossil fuels and results in a substantial amount of CO_2 emissions. Blue hydrogen is also produced from fossil fuels, but the Carbon Capture and Storage (CSS) technology reduces the released CO_2 emissions, while green hydrogen is a sustainable and clean fuel produced from Renewable Energy Sources (RESs) [22], [23]. Nowadays, hydrogen is mostly produced by the process of steam reforming methane from natural gas, while nearly 4% of global hydrogen is produced via electrolysis. This production technology uses electricity to produce hydrogen from water, resulting in CO_2 emissions related to electricity generation, which depend on the electricity mix used [24]. Madsen et al. [25] investigated the feasibility of a fuel-cell-powered coastal research ship with green hydrogen produced via electrolysis. The research showed around 91% fewer life-cycle GHGs in comparison with a diesel-powered ship. However, by using grey hydrogen instead of green hydrogen, the overall life-cycle emissions would be higher than those of a diesel-powered ship. Recent studies on CO_2 mitigation consider the use of green hydrogen to transform captured CO_2 into synthetic liquid fuels, such as synthetic

natural gas. In this way, CO₂ is recycled, contributing to achieving the aim of global carbon neutrality [26], [27].

The major drawback of the use of hydrogen onboard is its storage, mainly due to its low density. Onboard storage options vary from a cryogenic tank with liquid hydrogen (LH₂), metal hydride storage at an ambient temperature, and a gaseous hydrogen (GH₂) tank. While GH₂ storage is small-scale and is used for mobile applications, LH₂ storage represents medium large storage for shipping purposes. By using LH₂ instead of GH₂, the tank size and costs decline [28]. In order to avoid storage issues, hydrogen can be produced onboard [29], either through the use of electricity and water by electrolysis [30], or through the use of hydrogen carriers, i.e. fuels that contain hydrogen [31]. The latter option simplifies the fuel supply chain and infrastructure since hydrogen carriers are more readily available and there are fewer problems with storage than with pure hydrogen. Hydrogen carriers are usually natural gas, methanol, ethanol, ammonia etc. [32].

Ammonia is particularly attractive since it is a carbon-free and hydrogen-rich fuel that can be easily liquefied. Along with an already established storage and transportation infrastructure, ammonia is highlighted as an economical fuel that can be used in fuel cells [33], [34]. However, ammonia is toxic, and potential leakage represents a key safety concern for its use as a marine fuel [35]. Ammonia is the second most produced chemical in the world, which serves mainly as a fertilizer. It is mainly produced through the Haber-Bosch process, where nitrogen from the air and hydrogen are combined under high temperature and pressure. Depending on its cleanliness and the way it is produced, grey, blue and green ammonia can be distinguished [36], [37].

Although each type of fuel cell can use hydrogen as a fuel, low-temperature fuel cells, i.e. the Proton Exchange Membrane Fuel Cell (PEMFC), cannot use hydrogen carriers. Besides, PEMFC requires pure hydrogen due to its sensitivity to impurities, i.e. CO can contaminate the platinum catalyst in a fuel cell [38]. Unlike high-temperature fuel cells, which provide internal fuel processing, the PEMFC requires pure hydrogen, or other fuel needs to undergo different types of fuel processing, depending on its constituent parts, e.g. hydrocarbons such as natural gas and methanol need to undergo reforming processes and a purifying process, while ammonia requires decomposition and a purifying process [39].

High-temperature fuel cells, such as the Solid Oxide Fuel Cell (SOFC) and Molten Carbonate Fuel Cell (MCFC), offer several advantages regarding power generation, i.e. high

efficiency, low noise, stable power output, and fuel flexibility [40]. The MCFC is a mature and expensive technology with low power density. The SOFC offers high power density, the potential to be incorporated in a system with a gas turbine, although mechanical vulnerability and high costs limit its wider application [31]. The major safety concerns of fuel cells are related to high-temperature fuel cells and the temperature of their exhaust gas, for which the proper insulation of pipes is required to prevent leakage. Therefore, in terms of safety, low-temperature fuel cells have an advantage over high-temperature ones, mainly due to the lower operating temperature [41]. However, the use of pure hydrogen is associated with a set of other requirements due to its flammability, potential for explosion, and its potential to the embrittle materials [42].

Fuel cell technology can be used for stationary and mobile applications, where it faces several challenges such as fuel supply and storage, complex design, high investment costs, etc. In addition, the technology for large-scale applications is not yet mature. Many attempts have been made to implement fuel cell technology in the maritime sector [43]. However, efforts primarily focus on using fuel cells to cover the auxiliary needs of ships by combining them in a hybrid power system. For example, Sapra et al. [44] presented the integration of a fuel cell with an internal combustion engine for use onboard long-distance ships, while Ahn et al. [45] investigated a hybrid power system, consisting of a marine generator, an SOFC and gas turbine onboard a large ethane carrier. Díaz-de-Baldasano et al. [46] focused on the design and integration of a methanol-fed SOFC with a diesel generator in a ship power system installed onboard an offshore platform supply vessel. In total, 20% of energy needs were covered by the fuel cells.

Recent studies indicate interest in using fuel cells for ship propulsion. Wu and Bucknall focus on the modelling of a plug-in hybrid PEMFC/battery propulsion system for a coastal ferry and concluded that this kind of system can significantly reduce GHGs. However, high costs remain an issue [47]. Choi et al. [48] also investigate the ship power system with an integrated PEMFC and battery. Their study presents the detailed development of such a system onboard a ferry in Busan, South Korea. A PEMFC is indicated as a suitable onboard fuel cell for ships that operate near the shore and close to refueling tanks, while an SOFC is a potential candidate for high-power ships such as cargo ships and cruise ships [17]. Perčić et al. [49] performed an economic and environmental analysis of the use of alternative powering options for ships, among which a PEMFC with grey hydrogen is highlighted as the poorest environmental and economic alternative to replace the conventional diesel power system.

However, grey hydrogen production requires fossil fuel, and it results in a high amount of pernicious emissions released into the atmosphere. Therefore, the exploitation of different fuel cells, different hydrogen carriers, and types of fuel with regard to production processes, i.e. grey, blue and green types of fuel, should be further investigated to obtain a fair insight into the feasibility of fuel cell technology in the shipping sector.

Based on the above literature overview, knowledge gaps are indicated as follows:

- Studies on fuel cell systems as a ship's sole powering option are limited since most are oriented only to the auxiliary energy needs of the ship.
- There is a lack of studies that simultaneously include an environmental and economic analysis of different types of fuel cells used in power systems onboard ships over their lifetime. To the best of the authors' knowledge, there are no studies offering a comparison of the lifetime emissions and costs of fuel-cell-powered vessels and conventional diesel-powered vessels in coastal navigation, which is the most suitable for the implementation of innovative powering solutions.
- Research into zero-carbon fuels for waterway transportation, which takes into account their different production paths, is lacking. Most studies investigate either hydrogen or ammonia, but usually they are not specified as grey, blue or green hydrogen or ammonia. So, both the environmental benefit and economic potential of these fuels are not clear for marine applications.
- To the best knowledge of the authors, there are no studies that take into account different options of heating the fuel cell within the scope of marine applications. This is a highly important issue in coastal navigation, particularly for vessels with strict navigation schedules, like ferries, passenger ships, etc.

In this paper, the environmental and economic aspects of ships powered by PEMFCs and SOFCs are investigated where zero-carbon fuels (hydrogen and ammonia) are used. As a test case, the Croatian short-sea shipping fleet is chosen, where three ferries that operate on different routes are selected. These kinds of ships represent appropriate test cases to investigate the applicability of new technologies in the shipping sector due to the moderate energy requirements and the proximity to the shore. A preliminary analysis indicated that 44 Croatian ferries operate on 23 domestic and 3 international lines (connecting Croatia with Italy) [50]. The application of technologies that result in no emissions, such as fuel cells fueled with zero-carbon fuels, besides having a lower environmental impact, results in a reduction in the

negative effect on human health, which is more pronounced when the ships, like coastal vessels, operate near populated areas. The global impact of fuel cells onboard such ships can be found in data obtained from the World Register of Ships (WROS) database [51], according to which 3,123 ferries are in service globally. Based on passenger and vehicle capacity, total engine power and dimensions, the WROS database indicates 626 ships that are similar to those selected for this paper.

By performing Life-Cycle Assessments (LCAs) and the Life-Cycle Cost Assessments (LCCAs) of different fuel cell configurations, their environmental and economic indicators are calculated and compared to the existing diesel power system configuration. Based on this comparison, viable fuels and fuel cell types that ensure lower emissions at reasonable costs are highlighted. The contributions of this paper are summarized as follows:

- Development of a model for the application of particular zero-carbon fuel in PEMFCs and SOFCs on board ro-ro passenger ships and used as the only power source satisfying total ship energy needs.
- Identification of feasible fuel cell power systems with particular fuels onboard Croatian ro-ro passenger ships that satisfy environmental and economic criteria, bearing in mind future emission targets [9].
- Environmental and economic analysis of zero-carbon fuels, i.e. hydrogen and ammonia, and their grey, blue and green types implemented in a fuel cell.
- Development of a model for onshore and onboard heating of both PEMFCs and SOFCs.

The importance of the considered problem derives from the fact that, excluding nuclear power, the only options for zero-emission power production onboard ships are batteries and fuel cells.

2. Methodology

2.1. Ship data

The selected ships engaged in the Croatian short-sea shipping fleet are three ro-ro passenger ships, i.e. ferries that operate on short (Ship 1), medium (Ship 2), and relatively long routes (Ship 3) [49]. The ships are powered by conventional power systems, i.e. diesel engines. Their main particulars are presented in Table 1, and are obtained from the Croatian Register of Shipping [52], while the shipping schedules are taken from [53].

Table 1 Main ship particulars [49], [52], [53],

	Ship 1	Ship 2	Ship 3
Route	Prizna-Žigljen	Ploče-Trpanj	Vis-Split
Ship name	Prizna	Kornati	Petar Hektorović
Length between perpendiculars (m)	52.4	89.1	80
Breadth (m)	11.7	17.5	18.0
Draught (m)	1.63	2.40	3.80
Main engine(s) power, P_{ME} (kW)	792	1,764	3,600
Auxiliary engine(s) power, P_{AE} (kW)	84	840	1,944
Design speed, v_{de} (kn)	8.0	12.3	15.75
Passenger capacity	300	616	1,080
Vehicle capacity	60	145	120
Trip duration, t (min)	15	60	140
Route length, l (nm)	1.61	8.15	30.2
Annual number of return trips, N_{An}	1,590	1,740	800

The ships are designed to navigate at operating speeds, v_{de} (kn), which correspond to 70%–80% of the main engine load [54]. However, the operating speed of a ship is variable, depending on the weather conditions (e.g. waves), keeping to the schedule, voluntary speed reduction (slow steaming), etc. Therefore, based on the data on route length, l (nm), and its duration, t (h), the average ship speed, v_{ave} (kn), can be calculated.

By following up the cubic relationship between ship speed and power, the average main engine power, $P_{ME,ave}$ (kW), was calculated according to the following equation:

$$P_{ME,ave} = (P_{ME} \cdot 0.8) \cdot \left(\frac{v_{ave}}{v_{de}}\right)^3. \quad (1)$$

Assuming that the average load of the auxiliary engine, $P_{AE,ave}$ (kW), is 50%, the total average ship power, P_{ave} (kW), is calculated by summing $P_{ME,ave}$ and $P_{AE,ave}$. The energy consumption per distance, EC_D (kWh/nm), of an existing diesel-powered ship is then calculated according to:

$$EC_D = \frac{P_{ave}}{v_{ave}}. \quad (2)$$

It is assumed that a common lifetime (LT) of a conventional power system is 20 years. Hence, the environmental and economic performances of different ship power systems over 20 years are investigated.

2.2. Key performance indicators

In this paper, Key Performance Indicators (KPIs) are quantifiable values that reflect the environmental and economic performance of a ship power system [55]. Bearing in mind the extensive use of fossil fuel in the maritime sector, whose combustion generates different

emissions, the environmental KPIs are defined by taking into account the released emissions and consumed fossil energy.

The increased concentration of anthropogenic GHGs in the atmosphere represents a growing problem for the global community. Since GHGs are a mixture of different gases where CO₂ is the major one, while methane (CH₄) and nitrous oxide (N₂O) are present in a lower concentration, they each make a different contribution to global warming [6]. An evaluation of their contribution is performed by involving the Global Warming Potential (*GWP*), which is a measure of how much energy the emission of one ton of a gas will absorb over a given period relative to the emission of 1 ton of CO₂. Therefore, by using the CO₂-equivalent (CO₂-eq) factors over 100 years (CO₂: 1; CH₄: 36; N₂O: 298) [56], the environmental KPI within the impact category of climate change, *GWP*, is calculated according to the following equation:

$$GWP = 1 \cdot E_{CO_2} + 36 \cdot E_{CH_4} + 298 \cdot E_{N_2O}, \quad (3)$$

where *E* refers to the released emissions of a particular gas.

Shipping emissions can negatively affect both terrestrial and aquatic ecosystems through eutrophication and acidification. The SO₂ and NO_x emissions from the atmosphere fall to the ground in the form of acid rain/snow/mist and affect waters and soil, which consequently affect the level of nutrients in the body of water by causing eutrophication [57]. Therefore, the Acidification Potential (*AP*) is another environmental KPI. The *AP*, expressed in SO₂-eq, is calculated by multiplying the emissions of a particular acidifying gas by the SO₂-equivalence factors (NO_x: 0.7; SO_x: 1), as in the following equation:

$$AP = 1 \cdot E_{SO_x} + 0.7 \cdot E_{NO_x}. \quad (4)$$

Since the emissions of SO_x, NO_x and PM affect the formation of aerosol, which has a negative impact on human health, the Aerosol Formation Potential (*AFP*) is included as another environmental KPI. It is calculated by multiplying the emission quantities with PM 2.5 equivalence factors (PM 10: 0.5; SO_x: 0.54; NO_x: 0.88) [58]:

$$AFP = 0.5 \cdot E_{PM10} + 0.54 \cdot E_{SO_x} + 0.88 \cdot E_{NO_x}. \quad (5)$$

With the depletion of fossil fuels and moving towards sustainable energy resources, the considered KPI of Fossil Energy Demand (*FED*) is included in the analysis as the share of the fossil energy consumed.

As for the economic performance of a ship power system, the KPI of Net Present Value (*NPV*) is selected since it represents the total costs of the power system, discounted to the present value.

The KPIs are observed from the life-cycle point of view, where environmental KPIs are obtained by performing the LCA, while economic KPI is calculated within the LCCA. The selected KPIs are presented in Figure 1.

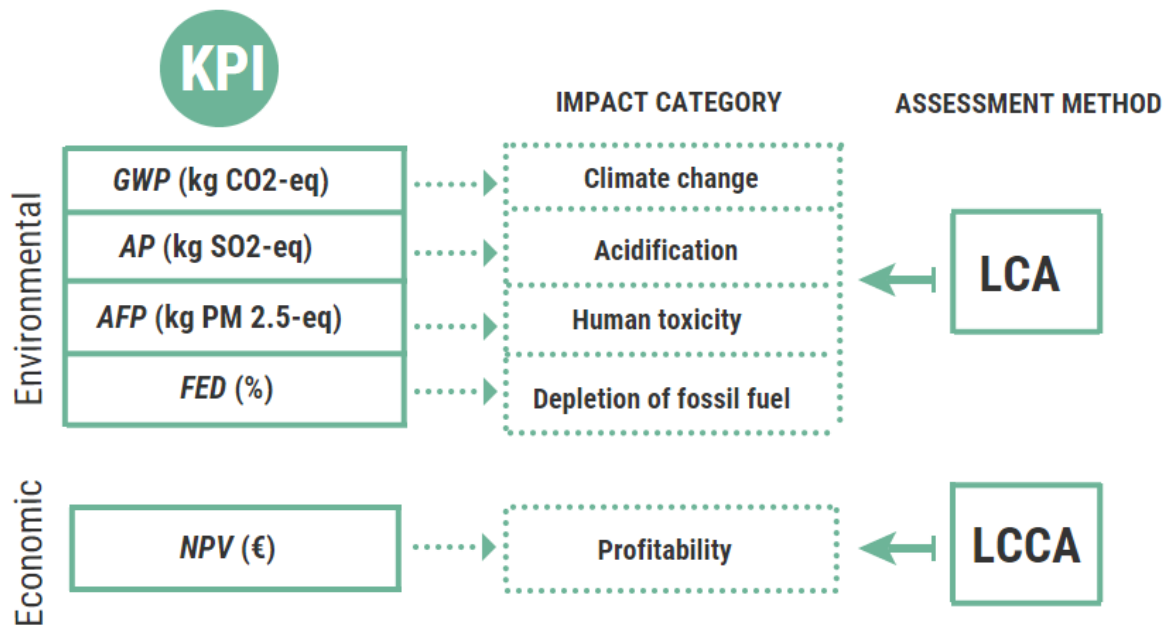

Figure 1. The defined KPIs

2.3. In general about life-cycle assessment

Increased awareness of atmospheric pollution and its negative effects encourages analysis of the environmental performance of a product. LCA is a technique for the analysis of the energy consumed and emissions released through each stage of the life cycle of a product, i.e. from the extraction of the raw material, the production of a product, the product's use, and the final disposal or/and recycling process [59].

By following the guidelines of ISO 14040 [59] and ISO 14044 [60], performing the LCA also requires a definition of the goal and the scope of the assessment, the functional unit, the system boundary and the life-cycle inventory. In this paper, LCA offers insight into the feasibility of different powering options of three ships by comparing the released emissions and energy consumed throughout the life cycle of a power system. Therefore, the system boundary is set on the ship power system. In the assessment, different environmental impact

categories are investigated. The functional unit, which enables the investigated power systems to be compared, is the lifetime mileage (LM) of each considered ship, calculated according to the following equation:

$$LM = LT \cdot N_{An} \cdot 2 \cdot l, \quad (6)$$

where N_{An} refers to the annual number of round trips, and l refers to the length of a one-way trip.

LCA is performed by means of the LCA software GREET 2020 [61], whose database contains many processes, fuel, and materials, primarily intended for the land transportation sector. Since the primary focus of the analysis is on the ship power system, the emissions and energy consumed are easily calculated by GREET 2020. The observed emissions and energy through the life cycle are divided into three categories. The first represents the Well-to-Pump (WTP) phase which includes the processes of raw material extraction, the production of fuel and its transportation to a pump. The second is the Pump-to-Wake (PTW) phase which refers to the use of a product, and, in this case, the use of fuel for the ship to operate. The third phase is the Manufacturing (M) phase which considers the emissions released and the energy consumed during the manufacturing of the main power system elements (battery, engine, fuel cell, etc.).

2.4. In general about life-cycle cost assessment

An economic analysis of different ship power systems highlights the most cost-effective powering option to be implemented on a particular ship [62]. In this paper, the total costs during the ship lifetime of 20 years are considered, and they are divided into two groups, i.e. *CapEx* and *OpEx*. *CapEx* represents the investment (capital) cost of a power system, while *OpEx* relates to the costs of the ship power system operation, i.e. fuel cost, maintenance cost, and equipment replacement cost, Figure 2.

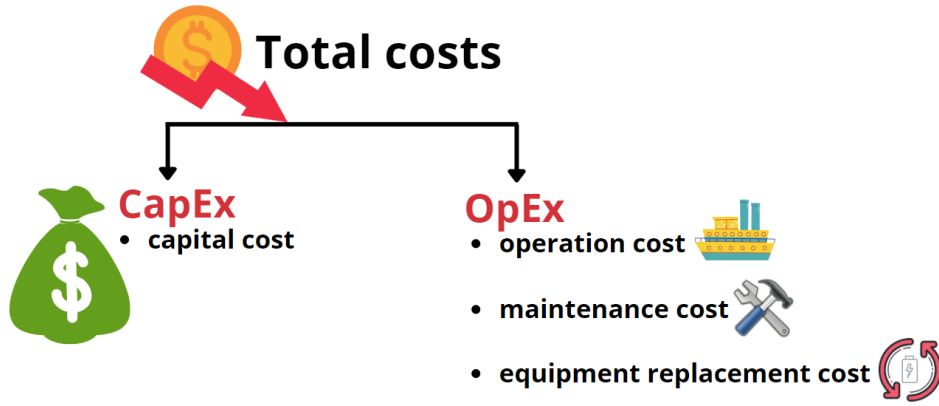

Figure 2. Costs included in the economic analysis

A proper cost comparison can be performed by reducing the total costs to the *NPV*, a measure that discounts the future costs to the present value. With an assumed discount rate (r) of 5%, the *NPV* of each ship power system can be calculated according to the following equation:

$$NPV = CapEx + \sum_{n=1}^{20} \frac{(OpEx_{An})_n}{(1+r)^n}, \quad (7)$$

where $OpEx_{An}$ represents the annual *OpEx* costs and n is the number of years, i.e. lifetime of a ship power system.

2.5. Considered power system configurations

A comparison was made of the fuel cell powering options with the baseline scenario, i.e. a diesel-powered ship, which is currently the most frequently used power system configuration in the Croatian short-sea shipping fleet.

2.5.1. Diesel-powered ship

Before analysing the fuel cell powering options, it should be stated that research into the Croatian short-sea shipping fleet indicated that it consists mainly of outdated ships with an average age of 29 years [50]. According to the national low-carbon development strategy [63], the transport sector should reduce its GHGs through a set of measures, such as the use of alternative fuels and the application of electric propulsion. Therefore, it is evident that, in the near future, conventional ship power systems should be replaced with alternatives.

2.5.1.1. The LCA of a diesel-powered ship

The environmental performance of a conventional diesel power systems was analysed by performing an LCA for each considered ship. The processes included in the analysis are the diesel engine manufacturing process, the processes of the WTP phase (crude oil recovery, its transportation to the refinery, diesel refining, and its distribution to the pump), and the process of combustion of diesel in the engine, Figure 3.

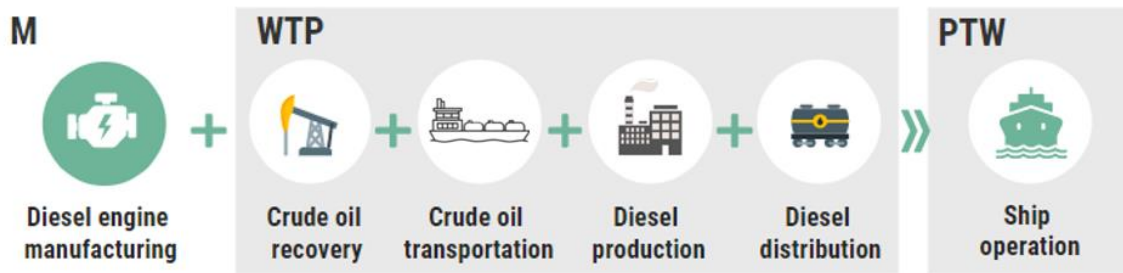

Figure 3. Processes included in the LCA of a diesel-powered ship

The feedstock for diesel production is crude oil, which, in the case of Croatia, is mostly imported from the Middle East. It is assumed that the crude oil is transported by tank trucks about 500 km from the recovery plant and exploitation site to the harbour from where the crude oil is transported via tanker (4,000 km) to the Croatian refinery, which is situated near the tanker terminal. The stationary process of diesel production, as well as the process of crude oil recovery, is obtained from the GREET 2020 database. After the diesel is produced, it is transported via a tank truck up to the corresponding refueling station. The distance of the diesel distribution process differs with the investigated ships. The distance for Ship 1 is equal to 100 km, while for Ship 2 it is 450 km, and for Ship 3 it is 350 km.

The PTW phase refers to the use of diesel for the ship's operation. The fuel consumption per distance, FC_D (kg/nm), of a ship is calculated by multiplying EC_D with the specific fuel consumption SFC_D (kg/kWh), such as in the following equation:

$$FC_D = EC_D \cdot SFC_D. \quad (8)$$

For high-speed diesel engines, the SFC_D is assumed to be 0.215 kg/kWh [64]. As a consequence of diesel combustion, emissions are released, E_{PTW} (kg/nm), and their amount is calculated by multiplying the FC_D with the emission factors, EF (kg emission/kg fuel), for a particular emission i (SO_x , NO_x , CO_2 , CH_4 , etc.):

$$E_{PTW,i} = FC_D \cdot EF_i. \quad (9)$$

The emission factors for diesel are obtained from [65].

The energy consumed and the released emissions during the process of manufacturing a diesel engine are included in the M phase. By considering the weight ratios of the materials contained in the diesel engine, as proposed in a study by Jeong et al. [66], the environmental performance of manufacturing the given engine is investigated. The weight of a particular material is calculated by multiplying the material's weight ratio with the weight of the engine and serves as an input into the GREET 2020 software. The weight of the engine, m (t), is calculated with the following relation [66]:

$$m = \frac{2 \cdot P_{ave}}{450}. \quad (10)$$

The overall emission, E_i (kg), of the entire power system during the lifetime of 20 years is calculated with the following equation:

$$E_i = LM \cdot (E_{WTP,i} + E_{PTW,i} + E_{M,i}), \quad (11)$$

where E_{WTP} (kg/nm) and E_M (kg/nm) are emissions i released during the WTP phase and the M phase. The calculated emissions are then used for the KPI calculation, and the energy consumed is obtained directly from the software.

2.5.1.2. The LCCA of a diesel-powered ship

The investment cost included in the *CapEx* of a diesel-powered ship refers to the purchase of a new engine, which is calculated by multiplying the average ship power with the assumed conversion factor of 250 €/kW [49].

The engine replacement is not considered due to the assumption that its lifetime is 20 years. Therefore, in the *OpEx* of a diesel-powered ship, the maintenance cost is calculated by multiplying the lifetime energy consumption with the conversion factor of 0.014 €/kWh [67], while the fuel cost is calculated by multiplying the lifetime fuel consumption with the Croatian diesel price of 0.78 €/kg [68].

2.5.2. Fuel-cell-powered ship

2.5.2.1. SOFC-powered ship

An SOFC consists of porous electrodes and a solid electrolyte, i.e. ceramics used as oxygen ion-conducting material. Oxygen (from the air) is fed from an external source into the fuel cell, where it is then reduced on the cathode to oxygen ions which are transported via an electrolyte to the anode. Hydrogen is then oxidized on the anode, resulting in electrons, and electricity is provided to the electric engine [69], [70].

Based on the geometry, an SOFC can be in planar or tubular form. Even though a tubular SOFC is more stable than a planar SOFC, the planar form is preferable due to the higher energy density and easier production [71]. In comparison to other fuel cell types, an SOFC is very flexible regarding fuel, and it offers high efficiency of around 65% in stand-alone operation, and even 70% when combined with gas or steam turbines [72]. However, due to the slow start-up, the integration of another power source, such as a battery, in an SOFC power system is very common [73]. The observed SOFC system is presented in Figure 4, and it is obtained from the study by Kim et al [74]. The battery is placed in the system depending on the way the operating temperature of the system is achieved, which is thoroughly discussed in subsection 2.5.2.3.

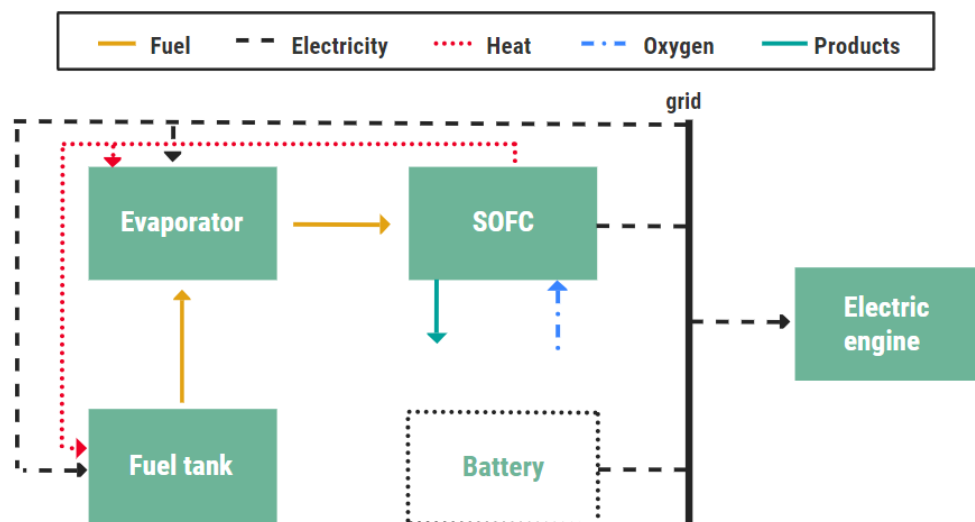

Figure 4. Onboard SOFC power system

According to Figure 4, the liquid fuel enters the evaporator where it is converted into gaseous fuel, which is then fed to the fuel cell. Due to high operating temperature, when entering the fuel cell, the hydrogen carriers are immediately decomposed into hydrogen and other compounds. In this particular case, the thermal decomposition of ammonia into nitrogen

and hydrogen occurs in the fuel cell, where hydrogen then oxidizes into water [33]. Another product that can be formed in a fuel cell is NO_x . However, by using an iron-based catalyst for the fast decomposition of ammonia, the formation of NO_x is negligible [75].

Due to the additional load of the equipment, the average power of the ship is increased by 10%, $P_{ave,SOFC}$ (kW), which is equal to the required power of a fuel cell, P_{SOFC} (kW). The fuel consumption of hydrogen and ammonia in an SOFC, i.e. FC_{SOFC-H} (kg/nm) and FC_{SOFC-A} (kg/nm), is calculated with the following equation:

$$FC_{SOFC-H} = \frac{EC_{SOFC}}{\eta_{SOFC} \cdot NCV_H}, \quad (12)$$

$$FC_{SOFC-A} = \frac{EC_{SOFC}}{\eta_{SOFC} \cdot NCV_H \cdot x_H}, \quad (13)$$

where η_{SOFC} refers to the fuel cell's efficiency, i.e. 65%, NCV represents the net calorific value of a fuel, x_H refers to the hydrogen content in ammonia, i.e. 17.8% [74], while EC_{SOFC} (kWh/nm) refers to the energy consumption of an SOFC-powered ship calculated by dividing the $P_{ave,SOFC}$ with the average speed. The NCV for hydrogen is equal to 33.33 kWh/kg (NCV_H) [76].

Various manufacturers guarantee different values of the lifetime of an SOFC, varying from 5,000h to 20,000 h [17]. Assuming that the further development of fuel cell technology will achieve a lifetime even greater than 20,000 h, this upper limit value is taken as the considered lifetime.

2.5.2.2. PEMFC-powered ship

A PEMFC is the most commercialized fuel cell, which is available in many applications, including in the maritime sector. It can reach an efficiency of 50-60%, but its main drawback is its intolerance to impurities and the requirement for pure hydrogen [71]. It contains a proton-conductive polymer electrolyte membrane placed between electrodes. Pure hydrogen as a fuel and oxygen are engaged in electrochemical reactions. The hydrogen is oxidized, the formed electrons result in electricity, while the formed protons due to the electrochemical gradient diffuse through the electrolyte up to the cathode. On the cathode, the oxygen is reduced, and its ions react with protons and form water [77]. The onboard PEMFC system fueled with pure hydrogen is presented in Figure 5, while the onboard PEMFC system fueled with ammonia is presented in Figure 6. The battery is placed in the system depending

on the way the operating temperature of the system is achieved, which is fully discussed in subsection 2.5.2.3.

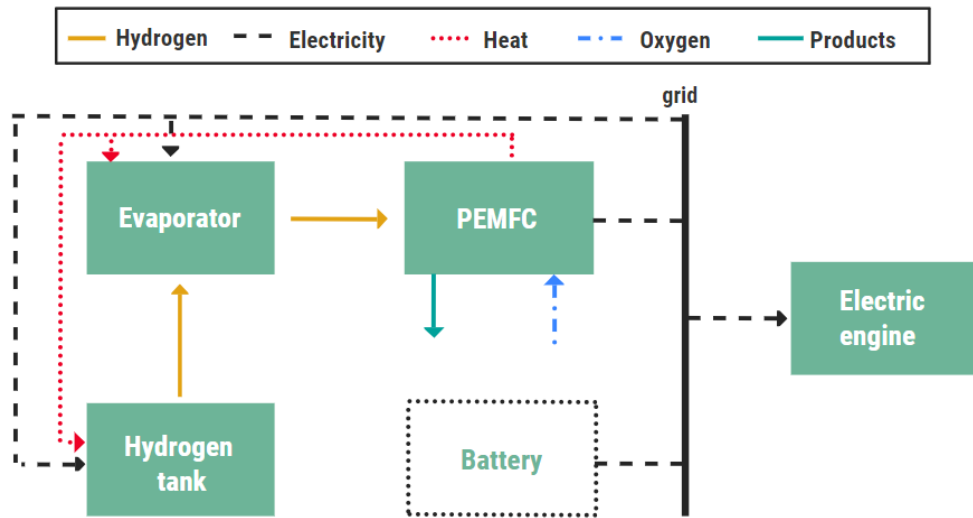

Figure 5. Onboard PEMFC system with pure hydrogen

Ammonia can be used as a fuel in a PEMFC, but its decomposition into hydrogen and nitrogen needs to occur in a separate unit before entering the fuel cell, Figure 6.

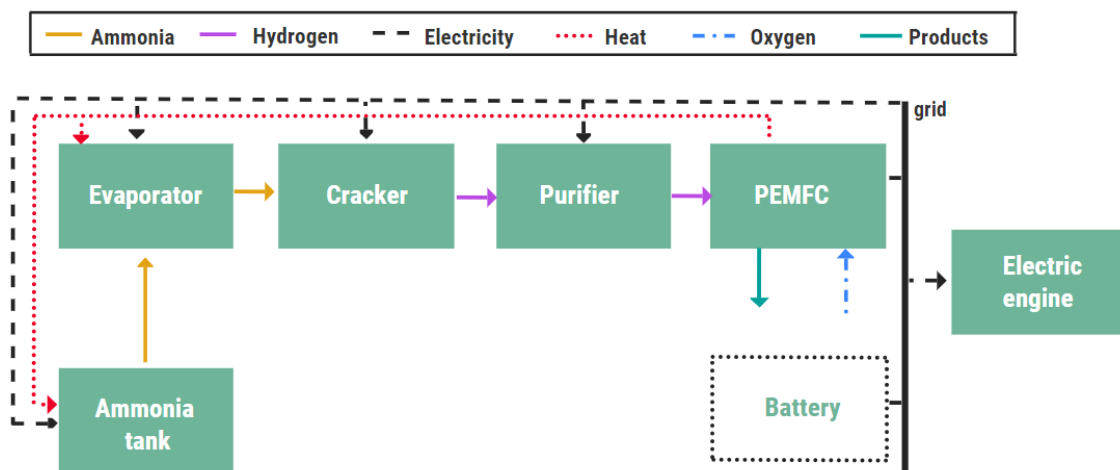

Figure 6. Onboard PEMFC system with ammonia

The required power of a fuel cell is calculated by taking into account that when using hydrogen, P_{ave} is increased by 10%, while when using ammonia, it is increased by 15% due to the additional equipment load. PEMFC power fueled with hydrogen is denoted as $P_{PEMFC-H}$ (kW), while the power of PEMFC fueled with ammonia is denoted as $P_{PEMFC-A}$ (kW). While

the fuel consumption of a hydrogen-powered fuel cell, $FC_{PEMFC-H}$ (kg/nm), is calculated with eq. (12), the fuel consumption of an ammonia-powered fuel cell, $FC_{PEMFC-A}$ (kg/nm), is calculated as follows, by taking into account the efficiencies of the cracker (η_C) (80%) and purifier (η_P) (90%) [74]:

$$FC_{PEMFC-A} = \frac{EC_{PEMFC-A}}{\eta_C \cdot \eta_P \cdot \eta_{PEMFC} \cdot NCV_H \cdot x_H}, \quad (14)$$

where η_{PEMFC} represents the efficiency of a PEMFC of 55%, while $EC_{PEMFC-A}$ (kWh/nm) refers to the energy consumption of a PEMFC-powered ship fueled with ammonia.

Despite all the advantages, the high costs and durability of a PEMFC are limiting factors for wider deployment. As reported a few years ago, the lifetime of a mobile PEMFC for automobiles was around 3,000 h, while a stationary PEMFC was around 30,000 h. The major reason for the increased degradation is the use of air and not pure oxygen as an oxidant [78]. However, due to the significant development of fuel cell systems, some recent studies have reported a lifetime of 10,000 h and even 20,000 h for a PEMFC operating onboard ship [17]. Assuming that the further development of fuel cell technology will extend its lifetime, this upper limit value is taken as the considered lifetime.

2.5.2.3. Reaching the operating temperature of a fuel cell system

One of the important characteristics of the operation of a fuel cell system, especially for transportation, is its start-up period, i.e. the time of reaching the operating temperature of the fuel cell system to start the process of electricity generation [78]. In this paper, two solutions of reaching the operating temperature of a fuel cell system are investigated, which differ by the way the energy is used for heating the fuel cell system (heating the fuel cell, fuel tank, evaporator, cracker and purifier):

- a) Heating the system with shore power while the ship is at berth,
- b) Heating the system onboard while the ship is operating, and a battery covers all the energy needs during the start-up period, Figure 7.

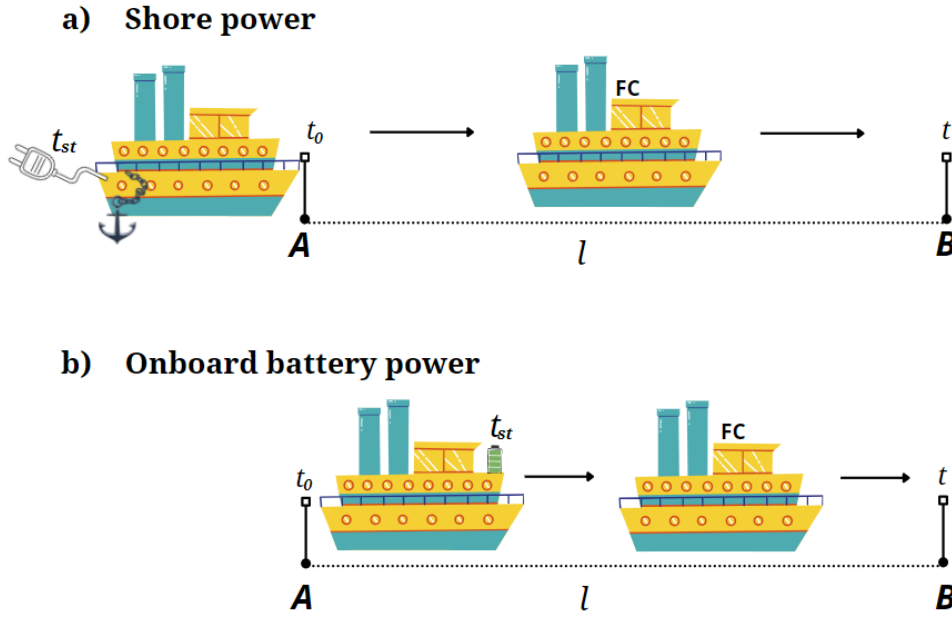

Figure 7. Considered options for reaching the operating temperature of a fuel cell system

The first option considers the heating up of the fuel cell system with shore electricity while the ship is at berth in a port. After the operating temperature is reached and the production of electricity starts, the ship leaves. This option depends on the ship's schedule, which is especially important for a ship powered by an SOFC which has a high operating temperature and requires a start-up period of around 30 minutes [78]. However, due to the ship's busy schedule, after the trip, the fuel cell system will not be fully cooled by the next departure. Therefore, the average start-up period of 20 minutes (t_{st}) is used in the analysis.

Unlike an SOFC, a PEMFC reaches its operating temperature and starts the process of electricity generation in a matter of seconds to minutes [77]. In this paper, it is assumed that within 3 minutes, the operating temperature of the system is reached by heating the system using shore power. When a PEMFC is fueled with ammonia, the required energy for heating the system, $EH_{PEMFC-A}$ (kWh), is calculated by multiplying the energy demand for starting up the system, i.e. 0.019 kWh/kW [74], with the power of the fuel cell, $P_{PEMFC-A}$ (kW):

$$EH_{PEMFC-A} = 0.019 \cdot P_{PEMFC-A} \quad (15)$$

However, when using hydrogen as fuel, the energy required for heating the system is lower due to the absence of a cracker and purifier. Therefore, for a PEMFC fueled with hydrogen, the energy demand for starting up the system is assumed to be 0.015 kWh/kW, and the required energy for heating the system, $EH_{PEMFC-H}$ (kWh), is calculated according to the following equation:

$$EH_{PEMFC-H} = 0.015 \cdot P_{PEMFC-H} \quad (16)$$

Since the start-up period of an SOFC is 6.7 times longer than that of a PEMFC, it is assumed that the energy demand for starting up the SOFC system is also 6.7 times greater than the energy demand of the PEMFC system. The energy for heating the SOFC system, EH_{SOFC} (kWh), is calculated as follows:

$$EH_{SOFC} = 0.015 \cdot 6.7 \cdot P_{SOFC} \quad (17)$$

The second considered solution for reaching the operating temperature of the fuel cell is to incorporate a battery into the ship power system. The battery handles the base loads of the thermal and electric energy demand of a system and also powers the ship until the fuel cell is ready to operate. The battery capacity needs to be sufficient to ensure navigation in that start-up period. Battery capacity, BC (kWh), is calculated according to the following equation:

$$BC = 1.5 \cdot (P_{ave,FC} \cdot t_{st} + EH_{FC}), \quad (18)$$

where EH_{FC} (kWh) refers to the power for heating a fuel cell system and, depending on the type of fuel cell and the fuel used, it is calculated with equations (15)-(17). The battery capacity is increased by 50% for safety reasons and to maintain the state of charge.

The lifetime mileage of a ship powered by a fuel cell, LM_{FC} (nm), is calculated as follows:

$$LM_{FC} = LM - LM_B, \quad (19)$$

where LM_B (nm) refers to the lifetime mileage of a ship powered by a battery, calculated according to the following equation:

$$LM_B = \left(\frac{t_{st}}{t} \right) \cdot LM, \quad (20)$$

where t (h) represents the duration of the entire trip.

2.5.2.4. The LCA of a fuel-cell-powered ship

Since hydrogen represents an ideal fuel for onboard fuel cells, the environmental performance of three different types of hydrogen is investigated. Grey and blue hydrogen are produced from natural gas, while green hydrogen is produced by RESs through the process of electrolysis. The processes included in the LCA are presented in Figure 8.

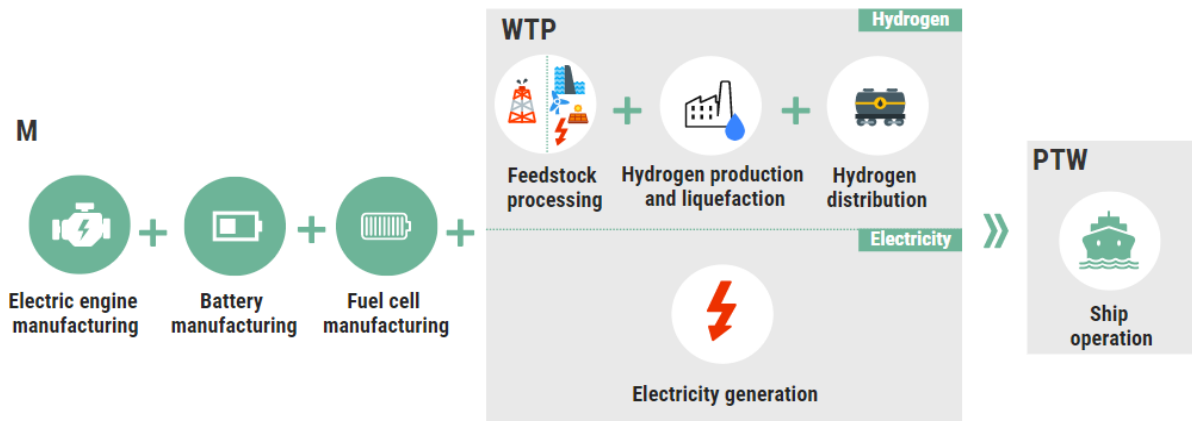

Figure 8. The processes included in the LCA of a hydrogen-powered ship

Feedstock processing for grey and blue hydrogen refers to the process of natural gas recovery, while for green hydrogen it refers to the electricity generation by solar, wind, and hydro energy. These stationary processes are obtained from the GREET 2020 database, while the transportation processes are modified. Since Croatia currently does not have a developed hydrogen market or production facilities, it is assumed that each type of hydrogen is produced in Western Europe, liquefied and transported to Croatia via tank trucks over a particular distance (Ship 1: 1,100 km; Ship 2: 1,450 km; Ship 3: 1,350 km).

In this paper, ammonia is considered as a potential hydrogen carrier for onboard fuel cells. The processes included in the LCA of an ammonia-powered ship are shown in Figure 9. The WTP phase involves feedstock processing, i.e. natural gas recovery or electricity generation from RESs, the production of grey, blue and green ammonia, and fuel distribution to the refueling station. It is assumed that the transportation process of ammonia is the same as for the transportation process of hydrogen.

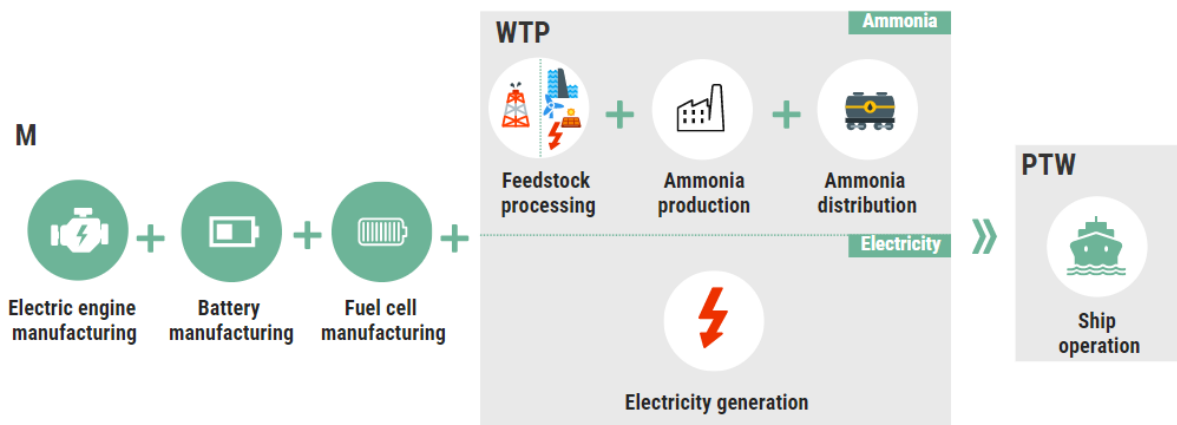

Figure 9. The processes included in the LCA of an ammonia-powered ship

Electricity is used during the start-up of the fuel cells. Therefore, each LCA of the fuel cell power system configuration also includes the electricity generation process within the WTP phase. In this analysis, the European electricity mix from the GREET 2020 database is used, Figure 10.

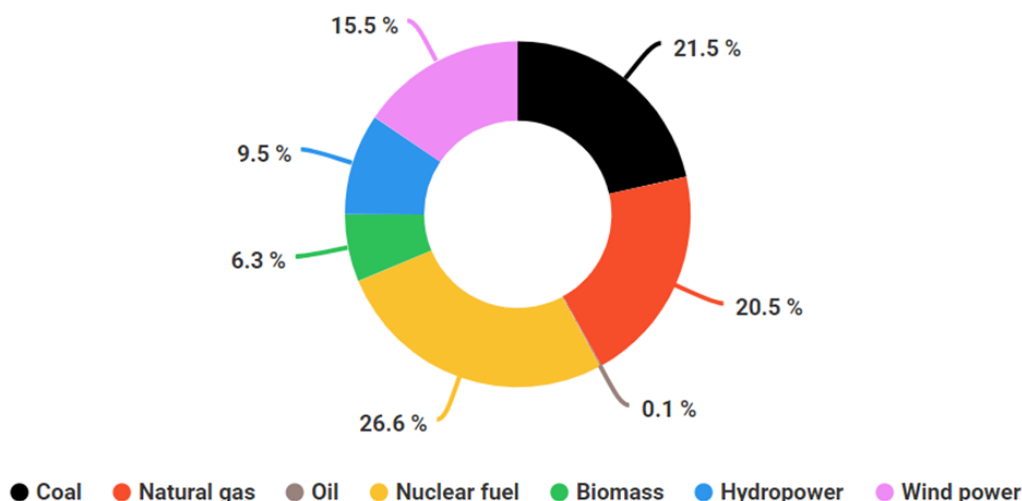

Figure 10. The European electricity mix obtained from the GREET 2020 database [61]

The M phase of each considered fuel cell configuration considers the manufacturing of the electric engine, the fuel cell, and the battery. While the environmental impact of an electric engine is calculated in the same way as for the diesel engine, the released emissions and energy consumed during the battery manufacturing process is obtained from the GREET 2020 database, where the only input is the weight of the battery. A Li-ion battery with nickel manganese cobalt oxide chemistry is considered, and its weight is calculated by dividing the required battery capacity with the energy density of 0.22 kWh/kg [80]. After the battery lifetime of 9,000 cycles of charging and discharging, the battery is replaced with a new one and is accounted for in the assessment. The environmental impact of a fuel cell is described by using the weights of materials used for manufacturing the SOFC [81] and the PEMFC [82]. Their replacement is considered by taking into account their operating hours.

The overall emissions are calculated with eq. (11) and their values are incorporated in the methodology for the KPI calculation. The energy consumed is obtained directly from the GREET 2020 software [61].

2.5.2.5. The LCCA of a fuel cell-powered ship

The economic analysis over the lifetime of a fuel cell power system is performed through LCCA, where the *CapEx* and *OpEx* are calculated. The prices for particular equipment and fuel are presented in Table 2.

Table 2. The considered prices for the economic analysis of a fuel cell-powered ship

Investment	Fuel cell	SOFC (€/kW)	2,200-7,670 [74], [83], [84]
		PEMFC (€/kW)	420-840 [74], [47], [48]
	Battery (€/kWh)		200 [85]
Fuel	Grey hydrogen (€/kg)		3.3 [86], [87], [88]
	Blue hydrogen (€/kg)		3.88
	Green hydrogen (€/kg)		5.8[86], [87], [88]
	Grey ammonia (€/kg)		0.31 [89]
	Blue ammonia (€/kg)		0.43
	Green ammonia (€/kg)		0.62
	Electricity (€/kWh)		0.078 [68]

The *CapEx* includes the investment cost of a battery and a fuel cell with the additional appropriate equipment, i.e. an electric motor, evaporator, etc. The investment cost of a battery is calculated by multiplying the required *BC* by its price. The investment cost of a particular fuel cell is calculated by multiplying its cost by its power. While various studies represent different prices presented in Table 2, it is assumed that the further development of fuel cell technology will result in lower prices. Therefore, the lower limit of the range is used as the fuel cell price. The liquid hydrogen storage cost is calculated by multiplying the amount of hydrogen required for the ship operation (during a round trip) with the NCV_H and liquid hydrogen storage price of 5 €/kWh. The required mass of hydrogen is increased by 20% for safety reasons [90]. The additional equipment is incorporated in the capital cost by increasing the cost of a fuel cell by 20% for an SOFC-powered ship fueled with either ammonia or hydrogen and a PEMFC-powered ship fueled with hydrogen. In order to take into account the required cracker and purifier for a PEMFC-powered ship fueled with ammonia, the investment cost of a fuel cell is increased by 30%.

The fuel costs include the costs of electricity, ammonia and hydrogen, whose prices are presented in Table 2. Whether the fuel cell is heated from the shore or during the ship operation, the overall cost of the electricity is calculated by multiplying its price for Croatian medium-size industry by the consumed electric energy. The European production costs of grey and green hydrogen are obtained from [86], and they are 1.5 €/kg for grey hydrogen and 2.5-5.5

€/kg for green hydrogen. To obtain the full price, the liquefaction cost of 0.9 €/kg, [87] and distribution costs of 0.9 €/kg, [88] are added to the average production price of grey and green hydrogen. Their final price for the Croatian case is 3.3 €/kg for grey hydrogen and 5.8 €/kg for green hydrogen. The global price of grey ammonia of 0.31 €/kg is obtained from a study by Hansson et al. [89]. However, the price of green ammonia is very different in the literature, mainly due to the cost of electricity and hydrogen required for its production [91], [92]. Since several studies predict that in 2040 the price of green ammonia will be less than 0.31 €/kg [93], [94], in this paper the price of green ammonia is assumed to be twice that of grey ammonia, i.e. 0.62 €/kg. Due to the lack of literature data on the prices of blue hydrogen and blue ammonia, they are calculated by increasing the grey hydrogen/ammonia price by the CCS cost, i.e. 60-90 €/ton of CO₂. Bearing in mind the prediction that the CCS cost in the early 2020s will be lower than 50 €/ton of CO₂ [95], the lower limit of the range is taken into account. According to the GREET 2020 database, the amount of CO₂ emissions released during the production of grey hydrogen is 10.7 kg per kg of hydrogen, while during the production of grey ammonia, 2.29 kg CO₂/kg ammonia is released. By considering that at least 90% is captured and stored, the CCS amounts to 0.58 € per kg of produced hydrogen and 0.12 € per kg of produced ammonia.

Besides fuel cost, within the *OpEx*, the maintenance and equipment (battery and fuel cell) replacement costs are included. While the lifetime maintenance cost of a power system refers to 10% of *CapEx*, the replacement cost takes into account the investment cost of the battery and fuel cell. However, it is assumed that their prices will decline by at least 25% by the time they need to be replaced, which represents their replacement cost.

2.6. Assumptions and limitations

The assumptions and limitations in this paper are listed as follows:

- The system boundary is fixed to the ship power systems. Hence, the environmental and economic KPIs are investigated through the emissions, energy consumed, and costs related only to the ship power system, while other units of the ship (e.g. the hull, additional equipment, crew, port operations, etc.) are not considered. However, this approach is sufficiently accurate to identify the technical solutions that result in emission reduction at a reasonable price, compared to the configuration of a conventional diesel power system.

- Within the LCA, the fuel distribution processes and the transportation of the raw material to the production facility are simplified. However, since the stationary processes make major contributions to overall WTP emissions, a change in the distribution and transportation pathways would not have a major impact on those emissions.
- The environmental impacts of the considered fuel cells are investigated based on the environmental footprints of the materials used in the process of their manufacture. However, data for some materials used in the manufacturing process of an SOFC and PEMFC are not available in the GREET 2020 database. Although some materials are omitted, the environmental assessment is still accurate since the M phase represents a minor contributor to overall emissions compared to the WTP phase.
- Further development of fuel cell technology will result in lower prices and in the better performance of fuel cells. Hence, in this paper, the considered lifetimes of fuel cells are taken as an upper limit value from the lifetime ranges obtained from the literature, while the considered costs of the fuel cells are the lowest among those found in the literature.
- The investment cost of additional equipment for the fuel cell system (e.g. cracker, purifier, etc.) are approximated. Since the investment cost of a fuel cell system is relatively minor compared to the fuel costs of the system, this approximation does not have a major influence on the final results.
- Short-term fluctuations of future fuel prices are not considered, and therefore the cost assessments follow the business-as-usual scenario. The only exception is the assumption that fuel cell prices and the battery price will decline by at least 25% by the time they will need to be replaced. The effect of diesel, green hydrogen and green ammonia fuel costs on the profitability of different power system configurations is presented in the analysis within the discussion section.

3. Results and discussion

The LCA and LCCA results of the implementation of different fuel cells and fuels are presented in Figure 11 and Figure 12. These results are used to select the best environmental and economical options for the fuel cell system on three ships for coastal navigation. The selected options are then compared with the diesel power system based on the calculated KPIs.

In the following results, Gy-H denotes grey hydrogen, B-H denotes blue hydrogen, Gn-H refers to green hydrogen, Gy-A represents grey ammonia, B-A refers to blue ammonia, while Gn-A denotes green ammonia.

In this paper, two ways of reaching the temperature of the fuel cell system are considered, i.e. heating the system with shore power when the ship is at berth (onshore), or heating the system with battery power while the ship is operating (onboard). However, heating the SOFC onboard Ship 1 (SOFC-onboard) is not considered since the duration of a one-way trip of the ship is shorter than the start-up period of an SOFC.

In the first step, the LCA results are used to highlight the most ecological use of a fuel cell with a certain fuel. Although other emissions are also analysed for different fuel cell systems, the emphasis is on the decarbonization of the shipping sector. Based on the LCA results, Figure 11, green hydrogen is indicated as the most environmentally friendly fuel solution from the global warming point of view, and it results in the lowest life-cycle CO₂-eq emissions.

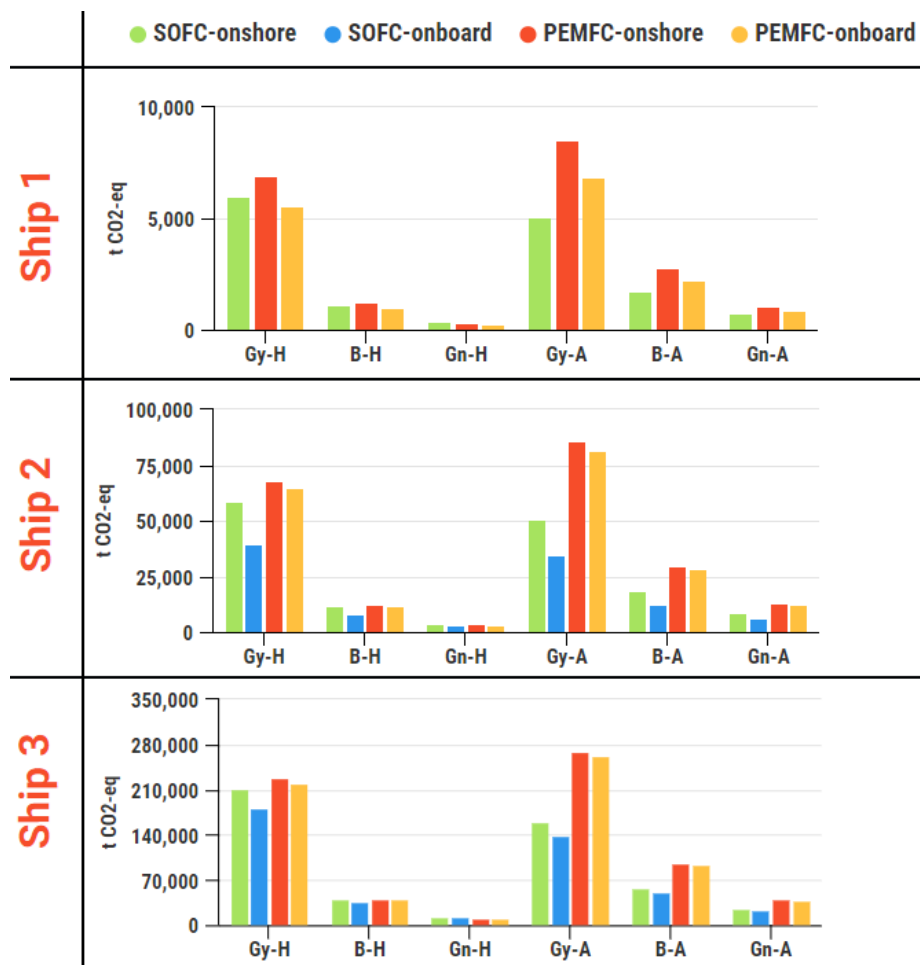

Figure 11. Life-cycle CO₂-eq emissions

The LCA comparison of the analysed power system indicates that heating the fuel cell system onshore results in higher life-cycle CO₂-eq emissions compared to the power system configuration when the fuel cell is heated onboard. The greatest impact of heating SOFC onboard on reducing emissions can be seen in the case of Ship 2. Due to the slow start-up period of an SOFC, Ship 2 is powered by a battery for around 2/3 of its route, while Ship 3 is powered by a battery for around 1/7 of its route. Therefore, the onboard heating of the SOFC on Ship 2 resulted in 33% lower CO₂-eq emissions than onshore heating, while for Ship 3, this reduction of emissions is around 14%.

Regarding the particular fuel cell, the use of an SOFC is an environmentally friendlier solution than the use of a PEMFC. The analysis indicates that the combination of grey hydrogen for an SOFC has the highest emissions among the considered fuels for an SOFC. However, when observing all the considered fuel cell types and different fuels, the grey ammonia used in a PEMFC, heated onshore, has the highest contribution to global warming. This is mainly due to the lower efficiency of the PEMFC compared to the efficiency of an SOFC, but also due to the PEMFC's requirement for pure hydrogen. The ammonia is firstly decomposed into hydrogen and nitrogen in a cracker, and then this hydrogen is purified in the purifier. By taking into account the losses in that equipment, the fuel consumption of ammonia is higher than it is for an SOFC system. Since grey ammonia is produced from natural gas in a process that is energy-intensive, the higher consumption of ammonia results in higher overall emissions.

The options that are nearly as environmentally friendly as the green hydrogen power system configuration are power systems with blue hydrogen and green ammonia as a fuel, especially for an SOFC-powered ship. Before the selected solutions are compared with the performance of a diesel-powered ship, the LCCA results, Figure 12, are observed to conclude which option has the potential to reduce emissions but is at the same time economical.

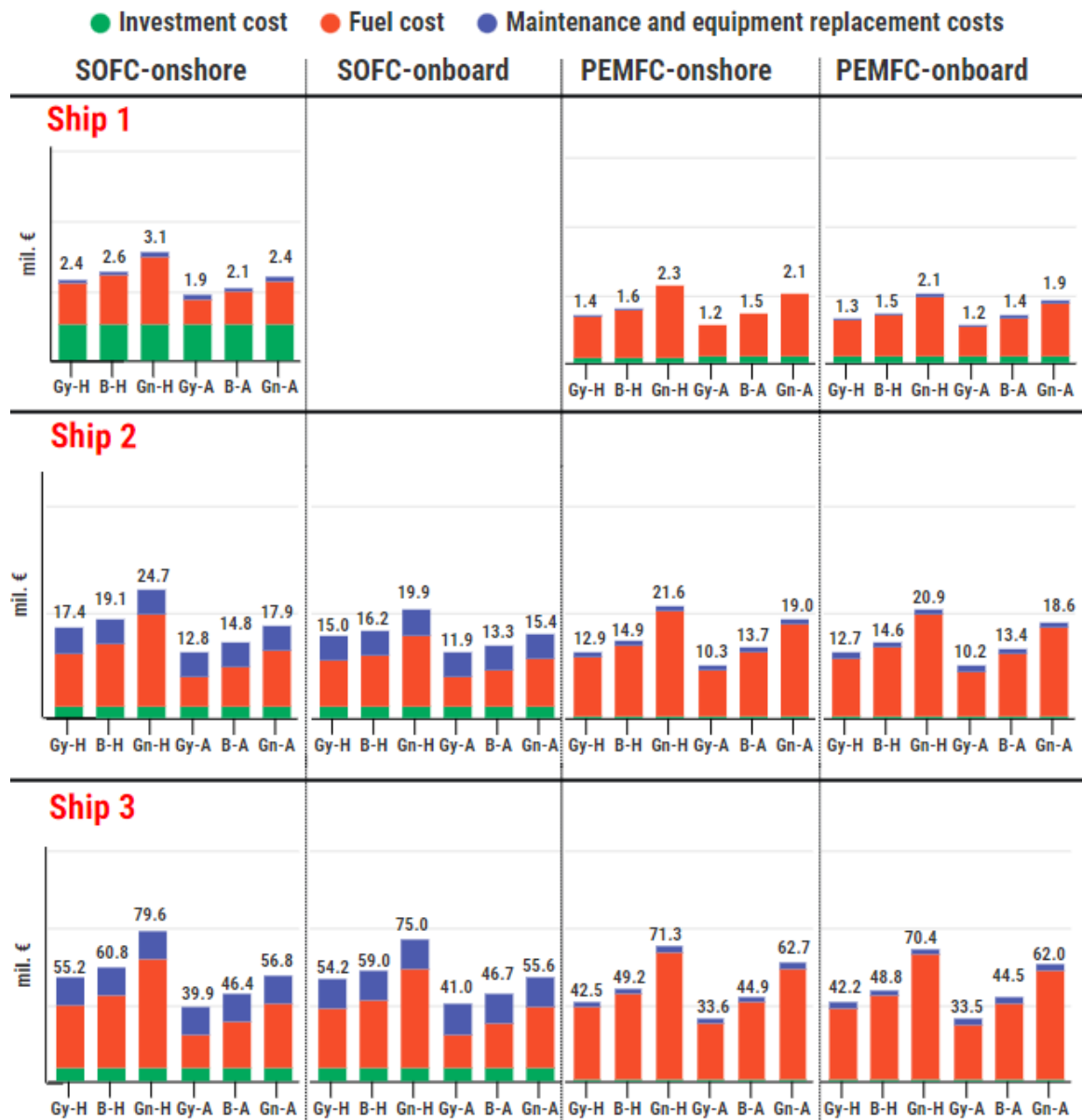

Figure 12. The LCCA results of the considered fuel cell systems

The LCCA comparison of PEMFCs and SOFCs for each considered ship indicates that the SOFC system implemented onboard results in higher costs than the PEMFC system. Even though the SOFC has higher efficiency than the PEMFC, and so requires less fuel for electricity generation, the capital cost of the SOFC system is higher than the capital costs of the PEMFC one. Regarding the method of reaching the required temperature for a fuel cell system, onboard heating, that is, when the battery heats the system and powers the ship, is the less expensive solution. This is mainly due to the fact that the electricity cost is far lower than the fuel cost. Exceptions can be observed in the case of Ship 3 and the SOFC powered by grey ammonia and blue ammonia. Regarding the fuel, grey ammonia is the most cost-effective fuel for the fuel cell. However, the LCA indicates high CO₂-q emissions when grey ammonia is used.

Although green hydrogen is the most environmentally friendly fuel that can be used in a fuel-cell-powered ship, the LCCA results show that green hydrogen is the most expensive fuel. The selected options for further comparison with the existing diesel-powered ship (denoted as D) are those whose released emissions and resulting costs are among the lowest of the analysed options, i.e. a fuel-cell-powered ship (onboard heated) with blue ammonia, green ammonia and blue hydrogen as fuels. The results of the comparison are presented in Figure 13.

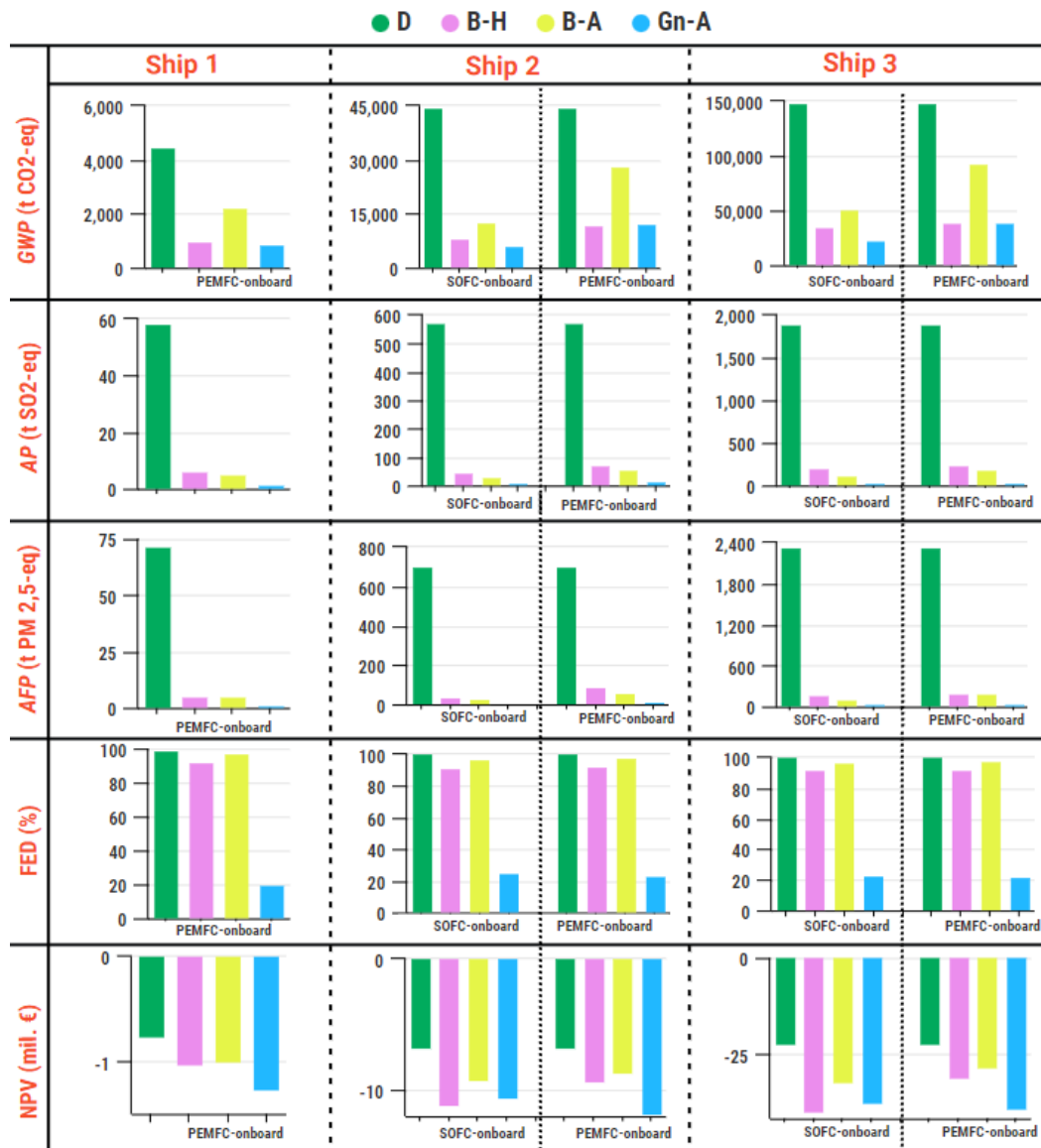

Figure 13. A comparison of the KPIs of different ship power systems

According to the comparison presented in Figure 13, the existing diesel-powered ship has the highest impact on climate change, acidification, human toxicity and depletion of fossil fuel. The results indicate that the fuel with the lowest environmental KPIs is green ammonia, with reductions in *GWP* by 72%-84%, in *AP* and *AFP* by 98%-99%, and in *FED* by 75%-80%,

compared to a diesel-powered ship. The environmental KPIs are higher when a PEMFC is used, except in the case of *FED*, when the use of an SOFC results in a slightly higher percentage of fossil energy demand.

Regarding profitability, the diesel power system configuration is the most cost-effective power system. The main reason for this is the low fuel and investment costs compared to fuel cell power systems. The second most cost-effective power system is the blue ammonia-powered ship, which, when compared to a diesel-powered ship, reaches 27%-43% higher *NPVs*, depending on the particular ship and type of fuel cell used. The investment cost of a ship power system with fuel cells mainly refers to the capital cost of a fuel cell. Since various prices of fuel cell stacks can be found in the literature, the sensitivity analysis of the *NPV* of fuel cell options with respect to the fuel cell price was performed. The fuel cell price varies by $\pm 75\%$, with an increment of 25%. The results of the analysis are illustrated on Ship 2, fueled by green ammonia.

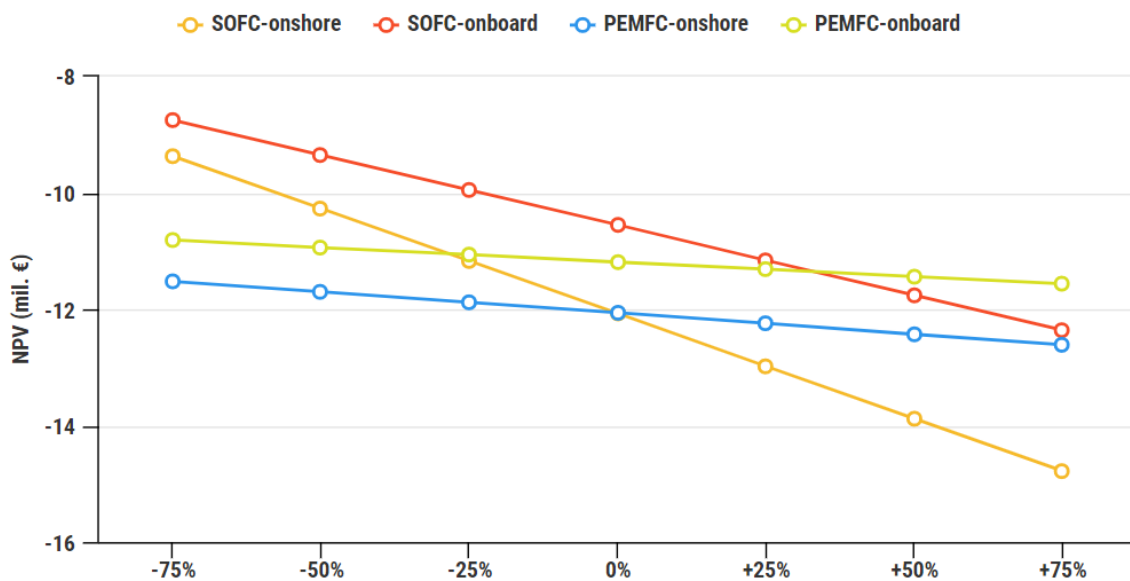

Figure 14. Sensitivity analysis of the *NPV* of different powering options with respect to fuel cell price

The greatest impact of the fuel cell price variations is shown in the case of an SOFC, especially when the SOFC is heated with onshore energy. In this case, due to the longer working hours of the fuel cell than when the SOFC is heated onboard, the fuel cell systems are replaced three times, while for the onboard heating of the SOFC, the maintenance cost refers to the replacement of the fuel cell twice and the replacement of the battery seven times. This

results in higher maintenance costs, which, along with higher fuel costs, affects the trendline of SOFC-onshore in Figure 14.

Besides hydrogen and ammonia, use of biofuels, especially biodiesel, in the ship power system is often investigated for the potentially great reduction of CO₂ emissions, given the general opinion that biofuels are carbon-neutral fuels, i.e. it is considered that the CO₂ emissions released during biofuel combustion are absorbed by biomass that will be further used for biofuel production [96]. In order to compare the environmental impact of biodiesel in the ship power system with that of diesel-powered ships and fuel cell options powered by hydrogen and ammonia, an analysis was performed where *GWP* and the total costs were compared. The fuel cell systems are heated on board, while the biodiesel is used as a diesel-biodiesel blend (B20), which contains 80% diesel and 20% biodiesel. The data on the life-cycle CO₂-eq emissions and life-cycle costs of a B20-powered ship are obtained from a study by Perčić et al. [49]. The results of the analysis are illustrated on Ship 2, and they are presented in Figure 15.

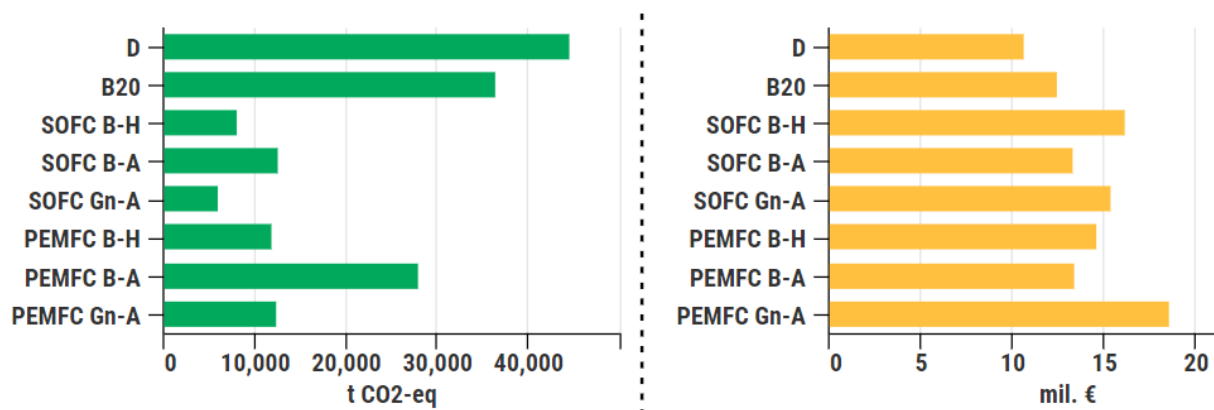

Figure 15. A comparison of the GWP and life-cycle cost of the investigated fuel cell ship power systems, the diesel-powered ship and the B20-powered ship

The biodiesel-diesel blend B20 results in higher emissions than the considered fuel cell options fueled with hydrogen and ammonia, but its life-cycle GHG emissions are still lower than the currently used diesel-power system configuration. Regarding the total costs, the B20-powered ship results in higher costs than the diesel-powered ship, but it represents a cost-effective option compared to the considered fuel cell options. With respect to the decarbonization goal set by IMO, biodiesel used in a blend with a great share of diesel should not be considered as a substantial decarbonization measure.

In summary, the use of green ammonia, blue ammonia and blue hydrogen in fuel cell systems installed onboard ships are highlighted as potential powering options which can be used to replace the diesel-power system. This replacement results in the reduction of GHGs, but it also increases the total costs. These data are summarized in Table 3.

Table 3. Results of the replacement of the diesel-power system with the considered fuel cell systems

	Diesel-powered ship replacement	
	Reduction of <i>GWP</i>	Increase of <i>NPV</i>
SOFC-onboard Gn-A	84% - 86%	56% - 68%
PEMFC-onboard Gn-A	72% - 80%	65% - 75%
SOFC-onboard B-A	65% - 72%	37% - 43%
PEMFC-onboard B-A	37% - 50%	27% - 29%
SOFC-onboard B-H	76% - 82%	64% - 80%
PEMFC-onboard B-H	73% - 78%	35% - 38%

An incentive for the application of these ship power systems with no tailpipe emissions could be the potential implementation of the carbon tax in the shipping sector. As investigated by Perčić et al. [49], the carbon tax can be observed in three scenarios, where the most rigorous is the Sustainable Development (SD) scenario, which reaches a carbon allowance cost of 115 €/ton of CO₂ by 2040. The carbon tax only refers to the tailpipe CO₂ emissions. By following up the methodology presented in this paper, the total annual CO₂ emissions of the Croatian ro-ro passenger fleet released during the diesel combustion in a ship engine is equal to around 50,000 t. The penalization of these emissions can be achieved with the SD scenario, which would lead to an increase of the *NPV* of existing ships by around 15%. This represents a great incentive towards the application of emission reduction measures. However, when compared to blue-ammonia-powered ships, their *NPVs* are still higher than those of the diesel-powered ship, ranging from 11% higher (Ship 1), 6% higher (Ship 2) and 7% higher (Ship 3) when using a PEMFC, while when using an SOFC, the *NPVs* of Ship 2 and Ship 3 are 15% and 20% higher, respectively.

Green ammonia is highlighted as a viable marine fuel and whose application in a fuel cell would result in achieving the IMO 2050 goal. Although it can be used directly in an SOFC, ammonia cannot be used directly in a PEMFC due to the potential poisoning of the platinum catalyst and a reduction of the membrane conductivity [96]. Hence, in this paper, the ammonia is firstly decomposed in a cracker, where further hydrogen is purified to eliminate all the impurities that could lead to PEMFC degradation. However, for the direct use of ammonia, the

Direct Ammonia Fuel Cell (DAFC) is a promising option. DAFC operates at a moderate temperature, and it is suitable for mobile applications [98]. However, the reaction of ammonia oxidation causes stability issues of the catalyst [99]. The solution for this is the use of an ammonia-based fuel cell with an anion exchange membrane which offers a robust and cost-effective alternative approach by enabling nonprecious electrocatalysts with acceptable performance, durability, and minimized system-level complexity [100], [101].

Interest in green ammonia has risen in recent years, driven by the decarbonization goals of different sectors. Green ammonia represents a viable and economical competitive fuel whose carbon-neutral characteristic offers clean energy. Further development of the production technology of ammonia and a decrease in its price will widen its use in the energy sector [93].

An analysis was performed to gain insight into the influence of future fuel prices on the NPV of the investigated power system configurations with sustainable fuels, i.e. green ammonia and green hydrogen, and diesel fuel as a baseline scenario, and the results are illustrated with regard to Ship 2, Figure 16. The projections for diesel and hydrogen prices are presented in a study by Gonçalves Castro et al. [102], from where the trend of decline in the hydrogen price and trend of increase in the diesel price are obtained. Green ammonia's price is forecast to be below 0.31 €/kg, by 2040 [93]. The projections of fuel prices are also represented per m³ to account for the density of each fuel obtained from [103].

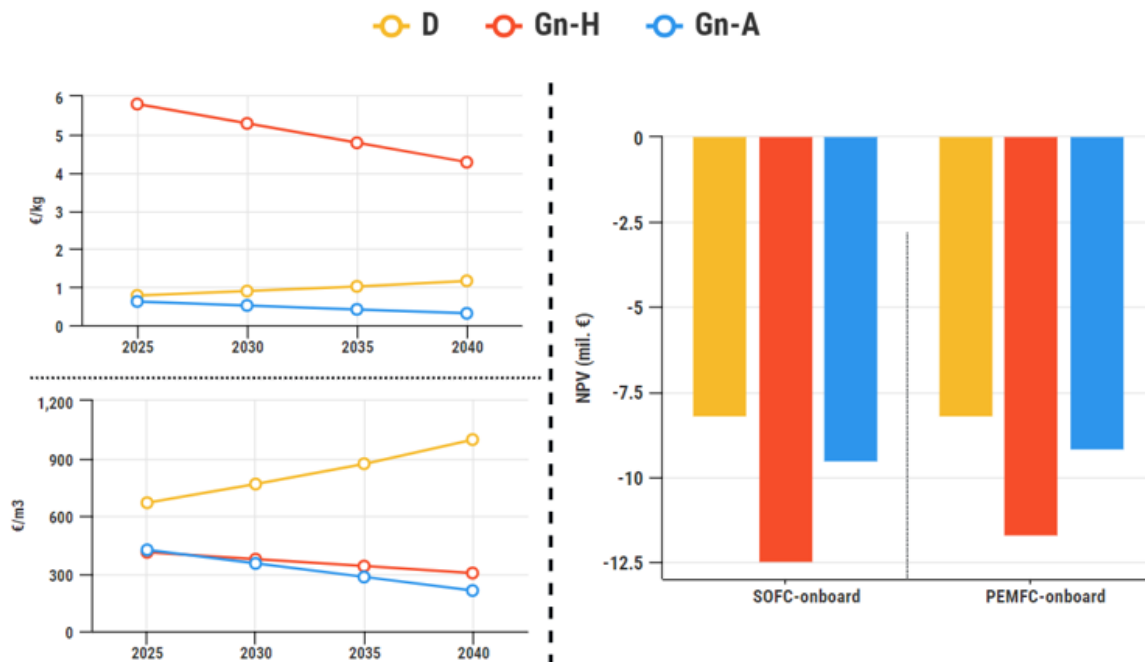

Figure 16. The projections of fuel prices up to 2040 (left) and an analysis of NPVs with respect to the forecast of future fuel prices (right)

The analysis indicates that green ammonia in a PEMFC heated onboard represents a promising alternative to diesel-powered ships with a great reduction in air pollutants, the fossil energy consumed, but where the *NPV* is slightly higher (by 12%). A greater impact can be seen in the decrease in the future price of hydrogen and ammonia in the case of a PEMFC-powered ship since its major cost is the fuel cost, and the investment cost is minor compared to the investment cost of an SOFC-powered ship. In comparison to the business-as-usual scenario, the *NPV* of diesel-powered ships increases by 17%, while the *NPV* of a green ammonia-powered ship is reduced by 10% when used in an SOFC and by 22% when used in a PEMFC. Even though the forecast predicts a decline in the price of green hydrogen, it is still an expensive fuel in comparison with green ammonia.

4. Conclusion

Fuel cells represent an innovative technology that could help in decarbonizing the shipping sector. This paper reports on research conducted on different fuel cell types, i.e. a low-temperature fuel cell (PEMFC) and a high-temperature fuel cell (SOFC), used as the powering option of three Croatian ro-ro passenger ships. Hydrogen and ammonia were investigated as fuel for a fuel cell, taking into account their type of production (grey, blue and green types of fuel). Based on the time required for the fuel cell system to heat up, two options were considered: the fuel cell system is heated when the ship is at berth, or the fuel cell system is heated by battery while the ship is operating, where the battery represents the main ship power source during the start-up period. In order to determine which fuel cell and fuels are both environmentally friendly and economical, LCA and LCCA were performed and used to calculate the environmental and economic KPIs. The selected fuels were compared with the existing diesel-powered ship based on their KPIs. The main findings of the research can be summarized as follows:

- The performed LCA indicated that the use of a PEMFC in a ship power system results in higher CO₂-eq emissions than the use of an SOFC onboard. The main reason is the lower efficiency of the PEMFC compared to the SOFC, which results in a higher amount of fuel required for the same amount of electricity output. The higher fuel consumption results in higher emissions.

- Although the LCA showed green hydrogen to be the most environmentally friendly fuel, the LCCA results indicated that the use of that fuel is not cost efficient since it is more expensive than the other considered fuels.
- The total costs of the fuel cell system powered by grey ammonia are the lowest among the considered options. However, this fuel is not considered acceptable for use onboard since its use results in high emissions.
- The LCCA showed that the SOFC power system configuration has higher total costs than the PEMFC power system configuration. Even though the SOFC has higher efficiency and requires less fuel for electricity generation, the capital cost of the SOFC system is higher than the capital costs of the PEMFC one.
- Both the LCA and LCCA results showed that heating the fuel cell system with onshore power results in higher emissions and higher total costs than the option of onboard heating.
- Following the LCA and LCCA results, blue hydrogen, blue ammonia and green ammonia were selected for comparison with a diesel-powered ship. While the diesel power system configuration resulted in the highest environmental KPIs, its economic KPI, i.e. *NPV*, is the lowest among the considered options.
- The implementation of blue ammonia in an SOFC system onboard is highlighted as one of the most feasible solutions, which would result in a great reduction in GHGs of 65%-72%, but at an acceptable cost which is 37%-43% higher than that of a diesel power system. Another feasible solution that offers a great reduction of 73%-78% in GHGs at a cost that is 35-38% higher than a diesel-powered ship is the PEMFC-powered ship fueled with blue hydrogen.
- Although the considered fuel cell systems with different fuels are not economical, the fuel cell system with blue and green fuels (hydrogen and ammonia) satisfy environmental requirements. With the further development of supply chains and an appropriate infrastructure and a reduction of fuel prices, the fuel-cell-powered ship will become feasible. An analysis was performed with respect to the forecast of the future prices of sustainable fuels (green ammonia and green hydrogen) compared to diesel. The results indicate that the application of green ammonia in a PEMFC for maritime purposes would seem to be feasible after 2040, but green hydrogen will probably remain expensive compared to green ammonia.

Finally, although the research focuses on the case study of Croatia, the developed models for the application of SOFCs and PEMFCs onboard ships and models for the heating of the fuel cell system are generally applicable to other short-sea shipping sectors of other countries if a set of specific input data is available.

Acknowledgement

This research was supported by the Croatian Science Foundation under the project Green Modular Passenger Vessel for Mediterranean (GRiMM), (Project No. UIP-2017-05-1253). Maja Perčić and Ivana Jovanović, Ph.D. students, are supported through the “Young researchers’ career development project – training of doctoral students” of the Croatian Science Foundation.

The LCA analysis in this study was performed using GREET 2020 software produced by UChicago Argonne, LLC under Contract No. DE-AC02-06CH11357 with the Department of Energy.

Literature

- [1] Monteiro A, Russo M, Gama C, Borrego C. How important are maritime emissions for the air quality: At European and national scale. *Environmental Pollution* 2018; 242: 565-575.
- [2] Chu Van T, Ramirez J, Rainey T, Ristovski Z, Brown RJ. Global impacts of recent IMO regulations on marine fuel oil refining processes and ship emissions. *Transportation Research Part D: Transport and Environment* 2019; 70: 123–134.
- [3] Chen L, Yip TL, Mou J. Provision of Emission Control Area and the impact on shipping route choice and ship emissions. *Transportation Research Part D: Transport and Environment* 2018; 58: 280-291.
- [4] Emission Standards: IMO Marine Engine Regulations, <https://dieselnet.com/standards/inter/imo.php#s>; [accessed 13 April 2021].
- [5] Marine environment protection committee (MEPC). Report of the MEPC’s 62nd session, <https://euroshore.com/sites/euroshore.com/files/downloads/mepc%2062-24.pdf>; 2011 [accessed 15 April 2021].
- [6] United Nations Framework Convention Climate Change (UNFCCC). Climate Change Information kit, <https://unfccc.int/resource/iuckit/cckit2001en.pdf>; 2001 [accessed 10 February 2021].
- [7] Bataille C, Åhman M, Neuhoff K, Nilsson LJ, Fishedick M, Lechtenböhmer S, et al. A review of technology and policy deep decarbonization pathway options for making

- energy-intensive industry production consistent with the Paris Agreement. *Journal of Cleaner Production* 2018; 187: 960-973.
- [8] Chen J, Fei Y, Wan Z. The relationship between the development of global maritime fleets and GHG emission from shipping. *Journal of Environmental Management* 2019; 242: 31-39
- [9] International Maritime Organization (IMO). Fourth IMO GHG study-Final report, <https://safety4sea.com/wp-content/uploads/2020/08/MEPC-75-7-15-Fourth-IMO-GHG-Study-2020-Final-report-Secretariat.pdf>; 2020 [accessed 10 March, 2021].
- [10] Bouman EA, Lindstad E, Riialand AI, Strømman AH. State-of-the-art technologies, measures, and potential for reducing GHG emissions from shipping – A review. *Transportation Research Part D: Transport and Environment* 2017; 52: 408-421.
- [11] Xing H, Spence S, Chen H. A comprehensive review on countermeasures for CO2 emissions from ships. *Renewable and Sustainable Energy Reviews* 2020; 134: 110222
- [12] Sterling PlanB Energy Solutions (SPBES). Electrification of ships, <https://spbes.com/>; (accessed 22 March 2021).
- [13] Gagatsi E, Estrup T, Halatsis A. Exploring the potentials of electrical waterborne transport in Europe: the E-ferry concept. *Transportation Research Procedia* 2016; 14: 1571-1580.
- [14] Nuchtaree C, Li T, Xia H. Energy efficiency of integrated electric propulsion for ships – A review. *Renewable and Sustainable Energy Reviews* 2020; 134: 110145.
- [15] Geertsma RD, Negenborn RR, Visser K, Hopman JJ. Design and control of hybrid power and propulsion systems for smart ships: A review of developments. *Applied Energy* 2017; 194: 30–54. May 2017.
- [16] Welaya YMA, El Gohary MM, Ammar NR. A comparison between fuel cells and other alternatives for marine electric power generation. *International Journal of Naval Architecture and Ocean Engineering* 2011; 3 (2): 141–149.
- [17] Ma S, Lin M, Lin T-E, Lan T, Liao X, Maréchal F, et al. Fuel cell-battery hybrid systems for mobility and off-grid applications: A review. *Renewable and Sustainable Energy Reviews* 2021; 135: 110119.
- [18] Wang L, Hu J, Yu Y, Huang K, Hu Y. Lithium-air, lithium-sulfur, and sodium-ion, which secondary battery category is more environmentally friendly and promising based on footprint family indicators?. *Journal of Cleaner Production* 2020; 276: 124244.
- [19] Dwivedi S. Solid oxide fuel cell: Materials for anode, cathode and electrolyte. *International Journal of Hydrogen Energy* 2020; 45 (44): 23988–24013.
- [20] de-Troya JJ, Álvarez C, Fernández-Garrido C, Carral L. Analysing the possibilities of using fuel cells in ships. *International Journal of Hydrogen Energy* 2016; 41(4): 2853–2866.
- [21] Sundén B. Fuel cell types - overview, in *Hydrogen, Batteries and Fuel Cells*, Elsevier; 2019, p. 123–144.
- [22] Dawood F, Anda M, Shafiullah GM. Hydrogen production for energy: An overview. *International Journal of Hydrogen Energy* 2020; 45(7): 3847–3869.
- [23] Velazquez Abad A, Dodds PE. Green hydrogen characterisation initiatives: Definitions, standards, guarantees of origin, and challenges. *Energy Policy* 2020; 138: 111300.

- [24] Zhang C, Wei M, Eichman J, Saxena S, Muratori M, Guerra OJ. Flexible grid-based electrolysis hydrogen production for fuel cell vehicles reduces costs and greenhouse gas emissions. *Applied Energy* 2020; 278: 115651.
- [25] Madsen RT, Klebanoff LE, Caughlan SAM, Pratt JW, Appelgate Jr. TB, Kelety SZ, et al. Feasibility of the Zero-V: A zero-emissions hydrogen fuel-cell coastal research vessel. *International Journal of Hydrogen Energy* 2020; 45(46): 25328–25343.
- [26] Gao R, Zhang C, Jun K-W, Kim SK, Park H-G, Zhao T, Wang L, Wan H, Guan G. Transformation of CO₂ into liquid fuels and synthetic natural gas using green hydrogen: A comparative analysis. *Fuel* 2021; 291: 120111.
- [27] Gao R, Zhang C, Jun K-W, Kim SK, Park H-G, Zhao T, Wang L, Wan H, Guan G. Green liquid fuel and synthetic natural gas production via CO₂ hydrogenation combined with reverse water-gas-shift and Co-based Fischer-Tropsch synthesis. *Journal of CO₂ Utilization* 2021; 51: 101619.
- [28] Wang Z, Wang Y, Afshan S, Hjalmarsson J. A review of metallic tanks for H₂ storage with a view to application in future green shipping. *International Journal of Hydrogen Energy* 2021; 46 (9): 6151–6179.
- [29] Shusheng X, Qiujie S, Baosheng G, Encong Z, Zhankuan W. Research and development of on-board hydrogenproducing fuel cell vehicles. *International Journal of Hydrogen Energy* 2020; 45 (35): 17844-17857.
- [30] Ghenai C, Bettayeb M, Brdjanin B, Hamid AK. Hybrid solar PV/PEM fuel Cell/Diesel Generator power system for cruise ship: A case study in Stockholm, Sweden. *Case Studies in Thermal Engineering* 2019; 14: 100497.
- [31] van Biert L, Godjevac M, Visser K, Aravind PV. A review of fuel cell systems for maritime applications. *Journal of Power Sources* 2016; 327: 345-364.
- [32] Abdin Z, Zafaranloo A, Rafiee A, Mérida W, Lipiński W, Khalilpour KR. Hydrogen as an energy vector. *Renewable and Sustainable Energy Reviews* 2020; 120: 109620.
- [33] Wang Y, Gu Y, Zhang H, Yang J, Wang J, Guan W, et al. Efficient and durable ammonia power generation by symmetric flat-tube solid oxide fuel cells. *Applied. Energy* 2020; 270: 115185.
- [34] Cha J, Jo YS, Jeong H, Han J, Nam SW, Song KH, et al. Ammonia as an efficient CO_x-free hydrogen carrier: Fundamentals and feasibility analyses for fuel cell applications. *Applied Energy* 2018; 224: 194–204.
- [35] Hansson J, Månsson S, Brynolf S, Grahn M. “Alternative marine fuels: Prospects based on multi-criteria decision analysis involving Swedish stakeholders. *Biomass and Bioenergy* 2019; 126: 159–173.
- [36] Liu X, Elgowainy A, Wang M. Life cycle energy use and greenhouse gas emissions of ammonia production from renewable resources and industrial by-products. *Green Chemistry* 2020; 22 (17): 5751–5761.
- [37] Chisalita DA, Petrescu L, Cormos CC. Environmental evaluation of european ammonia production considering various hydrogen supply chains. *Renewable and Sustainable Energy Reviews* 2020; 130: 109964.

- [38] Darowicki K, Gawel L, Mielniczek M, Zielinski A, Hunger J, Jorissen L. The impedance of hydrogen oxidation reaction in a proton exchange membrane fuel cell in the presence of carbon monoxide in hydrogen stream. *Applied Energy*; 279: 115868.
- [39] Pei P, Wang M, Chen D, Ren P, Zhang L. Key technologies for polymer electrolyte membrane fuel cell systems fueled impure hydrogen. *Progress in Natural Science: Materials International* 2020; 30 (6): 751–763.
- [40] Wang F, Deng S, Zhang H, Wang J, Zhao J, Miao H, et al. A comprehensive review on high-temperature fuel cells with carbon capture. *Applied Energy* 2020; 275: 115342.
- [41] Inal BO, and Deniz C. Assessment of fuel cell types for ships: Based on multi-criteria decision analysis. *Journal of Cleaner Production* 2020; 265: 121734.
- [42] Abdelkareem MA, Elsaid K, Wilberforce T, Kamil M, Sayed ET, Olabi A. Environmental aspects of fuel cells: A review. *Science of The Total Environment* 2021; 752: 141803.
- [43] Sundén B. Fuel cell systems and applications, in *Hydrogen, Batteries and Fuel Cells*, Elsevier; 2019, p. 203–216.
- [44] Sapra H, Stan J, Reurings J, van Biert L, van Sluijs W, de Vos P, et al. Integration of solid oxide fuel cell and internal combustion engine for maritime applications. *Applied Energy* 2021; 281: 115854.
- [45] Ahn J, Ho Park S, Noh Y, Il Choi B, Ryu J, Chang D, et al. Performance and availability of a marine generator-solid oxide fuel cell-gas turbine hybrid system in a very large ethane carrier. *Journal of Power Sources* 2018; 399: 199-206.
- [46] Díaz-de-Baldasano MC, Mateos FJ, Núñez-Rivas LR, Leo TJ. Conceptual design of offshore platform supply vessel based on hybrid diesel generator-fuel cell power plant. *Applied Energy* 2014; 116: 91-100.
- [47] Wu P and Bucknall R. Hybrid fuel cell and battery propulsion system modelling and multi-objective optimisation for a coastal ferry. *International Journal of Hydrogen Energy* 2020; 45 (45): 3193–3208.
- [48] Choi CH, Yu S, Han I-S, Kho B-K, Kang D-G, Lee HY, et al. Development and demonstration of PEM fuel-cell-battery hybrid system for propulsion of tourist boat. *International Journal of Hydrogen Energy* 2016; 41 (5): 3591–3599.
- [49] Perčić M, Vladimir N, Fan A. Life-cycle cost assessment of alternative marine fuels to reduce the carbon footprint in short-sea shipping: A case study of Croatia. *Applied Energy* 2020; 279: 115848.
- [50] Ančić I, Perčić M, Vladimir N. Alternative power options to reduce carbon footprint of ro-ro passenger fleet: A case study of Croatia. *Journal of Cleaner Production* 2020; 271: 122638.
- [51] World Register of Ships (WROS) database, 2013. IHS FAIRPLAY.
- [52] Croatian Register of Shipping. Web report of a ship, <http://report.crs.hr/hrbwebreports/Default.aspx>; [accessed 10 December 2020].
- [53] Jadrolinija. Ferry lines schedule, <https://www.jadrolinija.hr/red-plovidbe/lokalne-linije-2020->; [accessed 10 December 2020].
- [54] Adland R, Cariou P, Wolff FC. Optimal ship speed and the cubic law revisited: Empirical evidence from an oil tanker fleet. *Transportation Research Part E: Logistics and Transportation Review* 2020; 140: 101972.

- [55] Environmental Key Performance Indicators, https://assets.publishing.service.gov.uk/government/uploads/system/uploads/attachment_data/file/69281/pb11321-envkpi-guidelines-060121.pdf; [accessed 15 March 2021].
- [56] Environmental Protection Agency (EPA). Understanding Global Warming Potentials, <https://www.epa.gov/ghgemissions/understanding-global-warming-potentials>; [accessed 26 March 2021].
- [57] Kim T and Chae C. Environmental Impact Analysis of Acidification and Eutrophication Due to Emissions from the Production of Concrete. *Sustainability* 2016; 8 (6): 578.
- [58] Mestemaker BTW, Castro MBG, van der Blom EC, Cornege HJ. Zero emission vessels from a shipbuilders perspective. 2nd International Conference on Smart & Green Technology for Shipping and Maritime Industries (Including Ballast Water Management) 2019.
- [59] ISO 14040. <https://www.iso.org/standard/37456.html>; [accessed 21 April 2021].
- [60] ISO 14044. <https://www.iso.org/standard/38498.html>; [accessed 21 April 2021].
- [61] GREET 2020. <https://greet.es.anl.gov/>; [accessed 30 June 2021].
- [62] Perčić M, Ančić I, Vladimir N. Life-cycle cost assessments of different power system configurations to reduce the carbon footprint in the Croatian short-sea shipping sector. *Renewable and Sustainable Energy Reviews* 2020; 131:110028.
- [63] Ministry of Economy and Sustainable Development, Republic of Croatia. Low-Carbon Development Strategy of the Republic of Croatia until 2030 with an outlook to 2050, https://mzoe.gov.hr/o-ministarstvu-1065/djelokrug-4925/klima/strategije-planovi-i-programi-1915/strategija-niskouglijicnog-razvoja-hrvatske/1930;_2020 [accessed 01 December 2020].
- [64] Ančić I, Vladimir N, Cho DS. Determining environmental pollution from ships using Index of Energy Efficiency and Environmental Eligibility (I4E). *Marine Policy* 2018; 95: 1-7.
- [65] IMO. Third IMO GHG Study, Executive Summary and Final Report, 2014.
- [66] Jeong B, Wang H, Oguz E, Zhou P. An effective framework for life cycle and cost assessment for marine vessels aiming to select optimal propulsion systems. *Journal of Cleaner Production* 2018; 187: 111-130.
- [67] Iannaccone T, Landucci G, Tugnoli A, Salzano E, Cozzani V. Sustainability of cruise ship fuel systems: Comparison among LNG and diesel technologies. *Journal of Cleaner Production* 2020; 260: 121069.
- [68] European Commission. Fuel price comparison, <https://ec.europa.eu/transport/sites/transport/files/2017-01-fuel-price-comparison.pdf>; 2017 [accessed 20 December 2020].
- [69] Baniyadi E and Dincer I. Energy and exergy analyses of a combined ammonia-fed solid oxide fuel cell system for vehicular applications. *International Journal of Hydrogen Energy* 2011; 36 (17): 11128–11136.
- [70] Li G, Gou Y, Qiao J, Sun W, Wang Z, Sun K. Recent progress of tubular solid oxide fuel cell: From materials to applications. *Journal of Power Sources* 2020; 477: 228693.
- [71] European Maritime Safety Agency (EMSA). “Study on the use of Fuel Cells in Shipping 2017.

- [72] van Biert L, Visser K, Aravind PV. A comparison of steam reforming concepts in solid oxide fuel cell systems. *Applied Energy* 2020; 264: 114748.
- [73] Baldi F, Moret S, Tammi K, Maréchal F. The role of solid oxide fuel cells in future ship energy systems. *Energy* 2020; 194: 116811.
- [74] Kim K, Roh G, Kim W, Chun K. A Preliminary Study on an Alternative Ship Propulsion System Fueled by Ammonia: Environmental and Economic Assessments. *Journal of Marine Science and Engineering* 2020; 8 (3): 183.
- [75] Jeerh G, Zhang M, Tao S. Recent progress in ammonia fuel cells and their potential applications. *Journal of Materials Chemistry A* 2021; 9 (2): 727–752.
- [76] Bicer Y and Dincer I. Clean fuel options with hydrogen for sea transportation: A life cycle approach. *International Journal of Hydrogen Energy* 2018; 43: 1179-1193.
- [77] Wang Y, Ruiz Diaz DF, Chen KS, Wang Z, Adroher XC. Materials, technological status, and fundamentals of PEM fuel cells – A review. *Materials Today* 2020; 32: 178-203.
- [78] Pei P and Chen H. Main factors affecting the lifetime of Proton Exchange Membrane fuel cells in vehicle applications: A review. *Applied Energy* 2014; 125 60-75.
- [79] Mohammadzadeh A, Naghib Zadeh SK, Saidi MH, Sharifzadeh M. Mechanical engineering of solid oxide fuel cell systems: Geometric design, mechanical configuration, and thermal analysis, in *Design and Operation of Solid Oxide Fuel Cells: The Systems Engineering Vision for Industrial Application*, Elsevier; 2019, p. 85–130.
- [80] Gandoman FH, Jagemont J, Gopalakrishnan R, Firouz Y, Kalogiannis T, Omar N, Van Mierlo J. Concept of reliability and safety assessment of lithium-ion batteries in electric vehicles: Basics, progress, and challenges. *Applied Energy* 2019; 251: 113343.
- [81] Strazza C, Del Borghi A, Costamagna P, Traverso A, Santin M. Comparative LCA of methanol-fuelled SOFCs as auxiliary power systems on-board ships. *Applied Energy* 2010; 87 (5): 1670–1678.
- [82] Garraín D and Lechón Y. Exploratory environmental impact assessment of the manufacturing and disposal stages of a new PEM fuel cell. *International Journal of Hydrogen Energy* 2014; 39 (4): 1769–1774.
- [83] Strazza C, Del Borghi A, Costamagna P, Gallo M, Brignole E, Girdinio P. Life Cycle Assessment and Life Cycle Costing of a SOFC system for distributed power generation. *Energy Conversion and Management* 2015; 100: 64–77.
- [84] Xing H, Stuart C, Spence S, Chen H. Fuel Cell Power Systems for Maritime Applications: Progress and Perspectives. *Sustainability* 2021; 13(3): 1213.
- [85] Tsiropoulos I, Tarvydas D, Lebedeva N. Li-ion batteries for mobility and stationary storage applications. *JCR Science for Policy Report*, <http://publications.jrc.ec.europa.eu/repository/bitstream/JRC113360/kjna29440enn.pdf>; 2018 [accessed 26 April 2021].
- [86] EU hydrogen policy. Hydrogen as an energy carrier for a climate-neutral economy, [https://www.europarl.europa.eu/RegData/etudes/BRIE/2021/689332/EPRS_BRI\(2021\)_689332_EN.pdf](https://www.europarl.europa.eu/RegData/etudes/BRIE/2021/689332/EPRS_BRI(2021)_689332_EN.pdf); 2021 [accessed 10 November 2021].
- [87] Hydroge Council. Path to hydrogen competitiveness: A cost perspective, <https://hydrogencouncil.com/wp-content/uploads/2020/01/Path-to-Hydrogen-Competitiveness-Full-Study-1.pdf>; 2020 [accessed 10 November 2021].

- [88] European Commission. Science for Policy Briefs, Assessment of Hydrogen Delivery Options, https://ec.europa.eu/jrc/sites/default/files/jrc124206_assessment_of_hydrogen_delivery_options.pdf; 2021 [accessed 10 November 2021].
- [89] Hansson J, Brynolf S, Fridell E, Lehtveer M. The Potential Role of Ammonia as Marine Fuel—Based on Energy Systems Modeling and Multi-Criteria Decision Analysis. *Sustainability* 2020; 12 (8): 3265.
- [90] Niaz S, Manzoor T, Pandith AH. Hydrogen storage: Materials, methods and perspectives. *Renewable and Sustainable Energy Reviews* 2015; 50: 457–469.
- [91] Gomez JR, Baca J, Garzon F. Techno-economic analysis and life cycle assessment for electrochemical ammonia production using proton conducting membrane. *International Journal of Hydrogen Energy* 2020; 45 (1): 721–737.
- [92] Fúnez Guerra C, Reyes-Bozo L, Vyhmeister E, Jaén Caparrós M, Salazar JL, Clemente-Jul C. Technical-economic analysis for a green ammonia production plant in Chile and its subsequent transport to Japan. *Renewable Energy* 2020; 157:404–414.
- [93] Cesaro Z, Ives M, Nayak-Luke R, Mason M, Bañares-Alcántara R. Ammonia to power: Forecasting the levelized cost of electricity from green ammonia in large-scale power plants. *Applied. Energy* 2021; 282: 116009.
- [94] Ammonia Energy Association. Industry report sees multi-billion ton market for green ammonia, <https://www.ammoniaenergy.org/articles/industry-report-sees-multi-billion-ton-market-for-green-ammonia/>; 2020 [accessed 15 May 2021].
- [95] Carbon capture cost: is it worth incorporating in the energy mix?, <https://www.power-technology.com/features/carbon-capture-cost/>; 2020 [accessed 16 May 2021].
- [96] Hammond GP, Seth SM. Carbon and environmental footprinting of global biofuel production. *Applied Energy* 2013; 112: 547-559.
- [97] Soloveichik GL. Liquid fuel cells. *Beilstein Journal of Nanotechnology* 2014; 5: 1399–1418.
- [98] MacFarlane DR, Cherepanov PV, Choi J, Suryanto BHR, Hodgetts RY, Bakker JM, Ferrero Vallana FM, Simonov AN. A Roadmap to the Ammonia Economy. *Joule* 2020; 4: 1186–1205.
- [99] Li Y, Wang H, Priest C, Li S, Xu P, Wu G. Advanced Electrocatalysis for Energy and Environmental Sustainability via Water and Nitrogen Reactions. *Advanced Materials* 2021; 33 (6): 2000381.
- [100] Ramaswamy N, Mukerjee S. Alkaline Anion-Exchange Membrane Fuel Cells: Challenges in Electrocatalysis and Interfacial Charge Transfer. *Chemical Reviews* 2019; 119: 11945–11979.
- [101] Li Y, Pillai HS, Wang T, Hwang S, Zhao Y, Qiao Z, Mu Q, Karakalos S, Chen M, Yang J, Su D, Xin H, Yan Y, Wu G. High-performance ammonia oxidation catalysts for anion-exchange membrane direct ammonia fuel cells. *Energy and Environmental Science* 2021; 14: 1449.
- [102] Gonçalves Castro M, Mestemaker B, Van Den Heuvel H. Towards zero emission work vessels: the case of a dredging vessel. *Proceedings of 2nd International Conference on Modelling and Optimisation of Ship Energy Systems (MOSES2019)*, Glasgow, Scotland, United Kingdom, 2019.

[103] Atilhan S, Park S, El-Halwagi MM, Atilhan M, Moore M, Nielson RB. Green hydrogen as an alternative fuel for the shipping industry. *Current Opinion in Chemical Engineering* 2021; 31: 100668.

ARTICLE 7

Preprint of the published journal article.

Modular approach in the design of small passenger vessels for Mediterranean

Nikola Vladimir *, Andro Bakica, Maja Perčić and Ivana Jovanović

Faculty of Mechanical Engineering and Naval Architecture, University of Zagreb, Ivana Lučića 5, 10002 Zagreb, Croatia; andro.bakica@fsb.hr (A.B.); maja.percic@fsb.hr (M.P.); ivana.jovanovic@fsb.hr (I.J.)

* Correspondence: nikola.vladimir@fsb.hr

Abstract: This paper deals with the modular concept in the design of small passenger vessels for Mediterranean, where the ship is assembled from three virtual modules (hull, power system and superstructure), enabling different vessel characteristics (speed, capacity, environmental performance, habitability, etc.). A set of predefined modules is established based on the investigation of market needs, where IHS Fairplay database is taken as a reference for ship particulars and power needs, while the set of environmental regulation scenarios and requirements on ship habitability are taken as relevant for the design of ship power system and superstructure modules, respectively. For the selected hull, series of computations have been conducted to obtain their resistance and power needs which are further satisfied in the above-described manner. Within the illustrative example a small passenger vessel with a capacity of 250 passengers is considered, with detailed description of relevant modules that fit to future design requirement scenarios. This approach is aimed for small scale shipyards with limited research capabilities, who can quickly get the preliminary design of the vessel which can be further optimized to the final solution.

Keywords: ship design; passenger vessel; modular approach; ship hull; hydrodynamics; superstructure; noise; ship power system; energy efficiency; emissions.

Citation: Lastname, F.; Lastname, F.;

Lastname, F. Title. *J. Mar. Sci. Eng.*

2021, 9, x.

<https://doi.org/10.3390/xxxxx>

Academic Editor: Firstname Lastname

Received: date

Accepted: date

Published: date

Publisher's Note: MDPI stays neutral with regard to jurisdictional claims in published maps and institutional affiliations.



Copyright: © 2021 by the authors. Submitted for possible open access publication under the terms and conditions of the Creative Commons Attribution (CC BY) license (<https://creativecommons.org/licenses/by/4.0/>).

1. Introduction

In the current practice, the ship design is generally approached with the aim of keeping building-cost at the minimum, often forcing low-cost designs and low value-added market solutions. This is particularly true for small passenger vessels aimed for short-sea shipping which are usually built by small shipyards which cannot sustain the high costs of innovation. Unlike other transport modes, vessels are generally produced in small series and the investment has a strong impact on the total vessel cost. Therefore, ships are often based on previous concepts and designs with essentially no modernization thus leading to poor energy efficiency improvements, high life-cycle costs and environmental impact. Moreover, ships have to satisfy large number of requirements which are contradictory to each other [1]. Nowadays, ship design is strongly influenced by regulations on emissions [2], owners of all kinds of ships are seeking higher standards of comfort for both crew and passengers, while economic criteria are permanently important. On the other hand, due to market uncertainty, it is difficult for ship designers to design a vessel that has the right size and capabilities for use over multiple decades [3]. According to [3], ship design can be described as a complex design problem [4] or a dancing landscape [5]. Furthermore, Zwaginga et al. [3] indicate that difficulties that appear in ship design due to increasingly complex mission statements and conflicting and changing requirements are regularly a consequence of persistent market uncertainty. McKenney [6] categorizes ship design to have two objectives; (i) the interpretation objective, determining the customer's requirements or vessel purpose and (ii) the prediction objective, predicting what

kind of design will fulfil the functional capabilities. To deal with complexity and create a design that best fits the determined function, companies develop their own design methods that help to guide the process [3]. Still, it can happen that a design fulfils its function (what it was designed for), but not its purpose (need of the user), thus risking expensive refits, cancellation, or overruns in cost and time [3].

As can be seen in [7], a traditional ship design process includes of a series of subsequent multistage iterations gradually increasing the design identification level, while recent literature is mainly related to ship hull design, [1], [7], [8], [9]. The conventional design and production paradigm can be changed by developing a new concept for a highly efficient passenger vessel class which can alleviate the design process and reduce the initial cost of more technologically advanced vessels by spreading the innovation costs over a much larger series. This paper deals with the modular approach in the design of small passenger vessels intended for operation in the Mediterranean Sea, where conceptual design of the ship is achieved by a set of pre-defined modules that include ship hull, power system, and superstructure. The ship modularity idea is present for a certain time in the relevant literature. It seems that it has captured much more interest in the field in the field of naval vessels [10], but due to the lack of publicly available information, it is very difficult to ensure smooth knowledge transfer in the field of merchant vessels. Therefore, the scientific literature on this challenging topic is rather weak, [11]. Jolliff [12] was the first who proposed a methodology for evaluation of ship modularity and module category definitions. With the modularity approach, the complexity is split into self-contained modules each one having system interfaces with others. In the shipbuilding field, the modularity concepts have been mainly developed for the equipment and superstructures and mostly for military applications, [13]. Such modularity approach was motivated by the needs of military ships which are being frequently reconfigured for different missions. Tvedt [14] dealt with a modular approach for offshore vessel design and configuration and focused on the development of a system that is able to efficiently develop and evaluate Offshore Support Vessel designs and alternative designs in conceptual and preliminary stages. He stated that the developed system was useful to efficiently develop design alternatives with good performance, but its applicability as a tool for use in the industry was not proved. In Misra and Sha [15] the hull is similarly considered as divided into three main components, where one stern, two bows, and two mid body components are considered. The two mid body components have the same profile of the aft section but are characterized by a different bilge radius (i.e. loading capacity) and the two bows are designed to match the two different fore sections. Three different ship lengths are obtained by varying the length of the mid body component and thus a total of twelve combinations can be derived. Although this solution goes in the direction of the hull modularity concept, there are some important limitations in the approach as the same bow and stern are used while varying the ship length, which necessarily implies that the hydrodynamic design cannot be optimum for the specific operating conditions. Modular approach is applied in practice by Damen [16], where the so-called Damen Modular Barge (DMB) is developed. It represents a container-sized floating unit that forms a versatile building block for all sorts of modular pontoons and vessels, offering different configurations that can be fitted with a range of equipment. With respect to length, a series of 20- and 40-foot container size modules are offered. An online configurator is provided, where these modules can be combined with different machineries, deck equipment wheelhouses, and accommodations [16]. It is claimed in [16] that DMBs can be stacked as standard containers and transported by truck, boat, plane, and train. However, these vessels are aimed to operate in coastal waters, inland waterways, lakes, and other landlocked waterways, while their exposure to sea condition and their behavior in waves remains not fully justified.

Generally, modularity is oriented to achieve different missions by the fundamentally same vessel (different equipment, superstructure, etc.). Here, the modularity is used to obtain vessels with different power system costs, emission performance, acoustic performance, etc., for the selected speed and capacity/number of passengers. As a novelty, the

modular concept considered in this paper includes three virtual modules, i.e. ship hull, power system module and superstructure module, which are established based on the technical characteristics of existing passenger vessels operating in the Mediterranean Sea and future market needs in terms of environmental friendliness and comfort. It particularly targets the conceptual design stage, Figure 1, where design freedom is average, with relatively low knowledge about the problem and rather high market uncertainty. By interchanging above modules, the ship basic mission remains the same, but the project can be quickly moved to another emission or comfort category which has direct effect on the total costs.

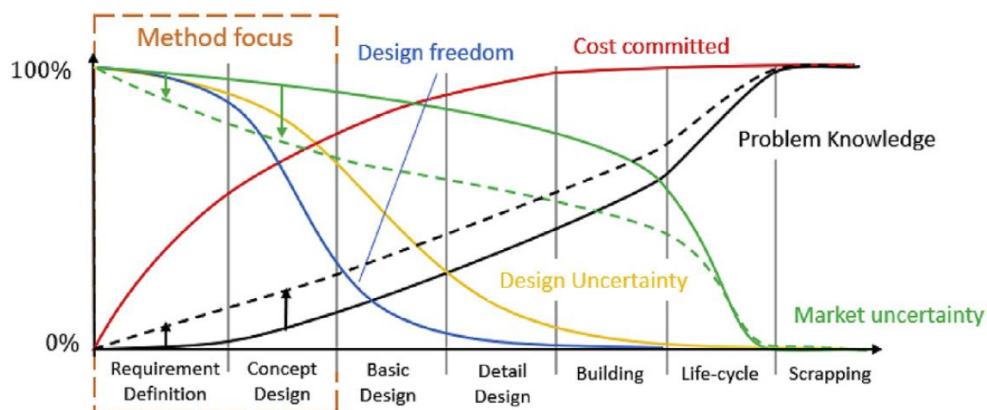

Figure 1. Ship design and exploitation over time [3], [17] (reproduced from [3] with permission of the Society of Naval Architects of Korea (SNAK), 2021)

The paper is structured into five sections. In the second section the methodology has been described, together with the modular concept itself and analysis of existing vessels and rules and regulations that are expected to be relevant over the ship lifetime. Third section is related to the materials and methods, where the ship hull is defined at the conceptual level, overview of available power system modules with their advantages and drawbacks is provided, together with considerations on the acoustic design of ship passenger spaces, where different insulation materials were examined to provide superstructure with target comfort class. In the fourth section, an illustrative example is given, which includes results of hydrodynamic computations of ship resistance and stability analysis, lifetime emissions and lifetime costs of different power system modules and selection of the most appropriate one for the targets vessels, as well as results of noise predictions confirming that the considered compartment fit to the required noise standard. Also, adaptation of the ship to different comfort class from the viewpoint of vibration is included. This represents pre-defined concept of the vessel which can be further optimized, as the design freedom decreases, Figure 1. Finally, in the fifth section concluding remarks are drawn.

2. Modular concept and identification of market needs

2.1. Modular concept

Developed methodology is schematically presented in Figure 2. The basic step includes analysis of market needs and technical characteristics of existing vessels. Based on the design task that prescribes ship capacity, speed, range, and that might include additional requirements in terms of comfort or environmental friendliness, preliminary ship hull dimensions are determined and submitted to the preliminary resistance calculations and power needs prediction, by simplified methods. Within this investigation, the NavCad software is used, [18], but any other tool providing a quick estimation of the above quantities can be used. Comparative analysis of power needs with the power needs

of similar ships available in the database [19], and after the acceptable agreement is confirmed, series of computations by computational fluid dynamics (CFD) tools is performed to obtain more reliable values. Depending on the power needs and allowable emissions, the most cost-effective power system module is selected. Similarly, depending on the target comfort level appropriate insulation of superstructure module is selected from a set of previously examined options.

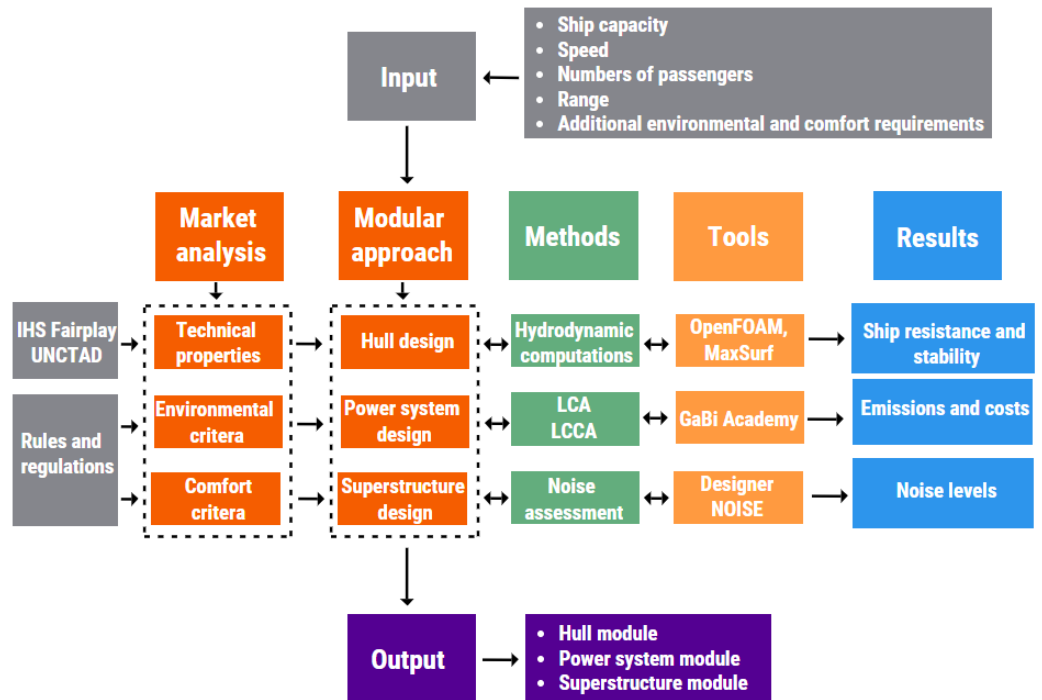

Figure 2. Methodology scheme

2.2. Identification of market needs

2.2.1. Technical properties of existing vessels in the Mediterranean

The first step in the analysis of technical properties of existing vessels is to limit the range of vessels according to some criteria. There are different criteria according to which the ship can be designated either small or big, as for instance the length, capacity, gross tonnage, etc. In this investigation, the length is selected as the relevant quantity and technical properties of all passenger ships registered in the Mediterranean countries with a length below 100 m are taken into account from the IHS Fairplay database [19]. The rules that are applicable to small vessels treat the upper length boundary very differently. In this sense, according to the International Association of Classification Societies (IACS) small ships are those below 24 m, while depending on the context they can be up to 65 m in length (Bureau Veritas) or even up to 100 m (Det Norske Veritas), [20].

Analysis is conducted for 692 passenger vessels operating under the flag from one of the Mediterranean countries, **Error! Reference source not found.**, built between 1999 and 2015. In Figure 3 ship particulars (length overall (LOA), draft, beam, and total installed power) are illustrated depending on the deadweight. It is obvious that the deadweight is not the most relevant quantity for passenger vessels, but it is regularly used because of its universal acceptance as a measure of ship size and because of its wide use in the reporting of statistical information.

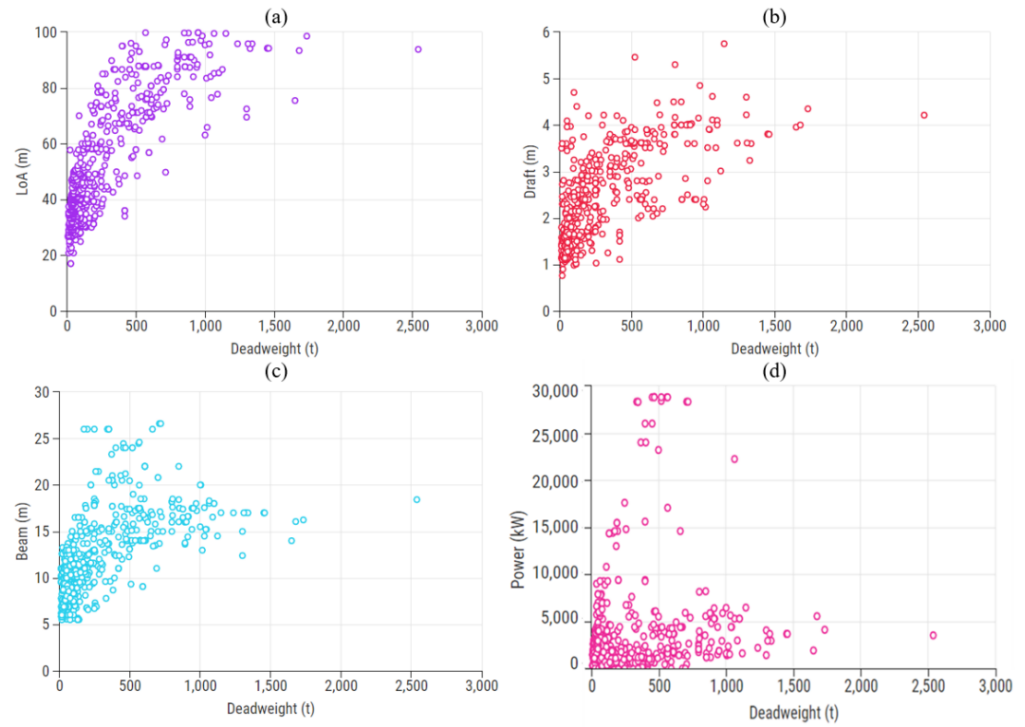

Figure 3. (a) Deadweight vs Length overall, (b) Deadweight vs Draft, (c) Deadweight vs Beam, (d) Deadweight vs Power

Taking into consideration that number of passengers is important parameter for passenger ships relationship between deadweight and number of passengers, and length overall and number of passengers is illustrated in Figure 4.

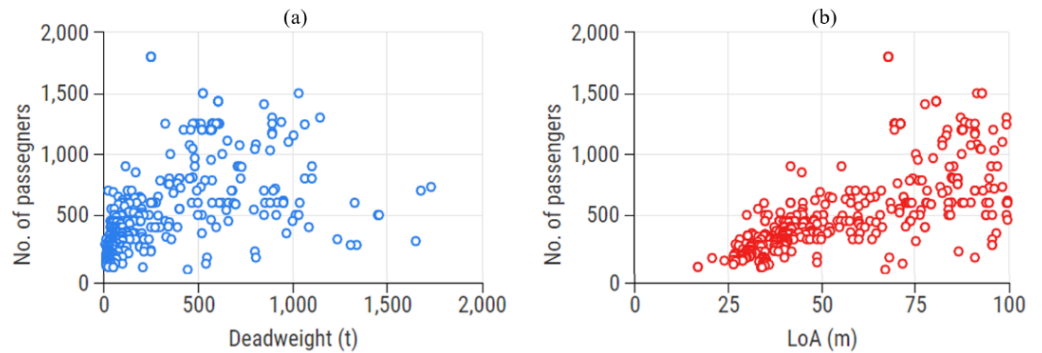

Figure 4. a) Deadweight vs Number of passengers, (b) Length overall vs Number of passengers

Most of the vessels is equipped with fixed pitch propellers, Figure 5.

170
171
172
173
174
175
176
177
178

179
180
181
182
183
184
185

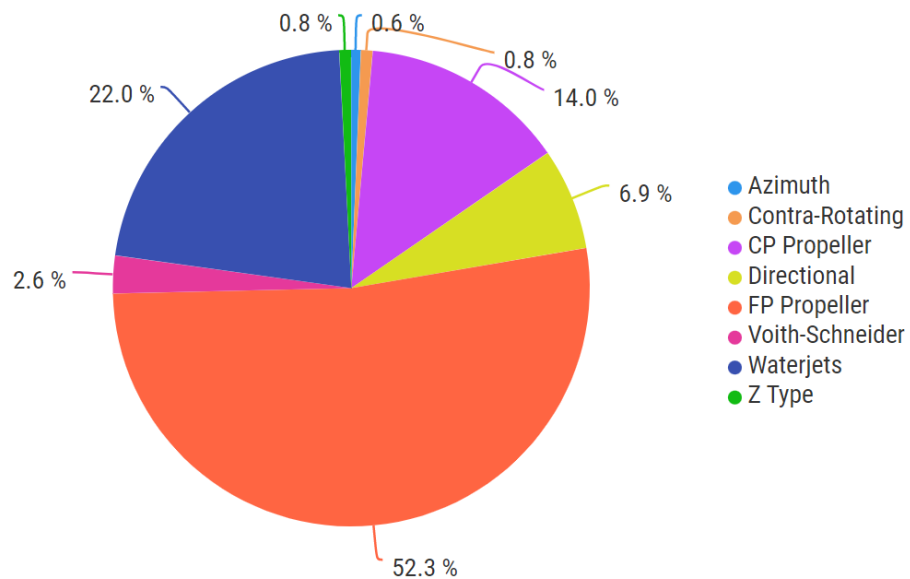

Figure 5. Type of propulsors in the considered passenger vessels

The above figures indicate that there is relatively large scattering between ship dimensions, capacity and power systems among the analyzed vessels. Based on that, it is obvious that no unified solution for the ship hull and consequently power system and superstructure is possible. Therefore, number of solutions for the mentioned modules are worked out.

2.2.2. Environmental requirements

One of the most important environmental problems nowadays is global warming, which is caused by the increased concentration of anthropogenic Greenhouse Gases (GHGs) in the atmosphere. Their high concentration in the atmosphere forms a thick layer that prevents solar irradiation to scatter into outer space. Instead, due to the developed greenhouse effect, the Earth is warming up, which causes climate changes [21]. The Paris Agreement is an international treaty on climate change, which aims to keep the global temperature rise below 2 °C, in comparison to the pre-industrial level. This aim requires a sharp reduction in GHG emissions in each sector [22], [23]. The major source of GHGs, as well other pernicious emissions (e.g. nitrogen oxides (NO_x), sulfur oxides (SO_x), particulate matter (PM) etc.), is fossil fuel combustion [24], [25]. While GHG negatively affects the environment on a global scale, NO_x, SO_x and PM are local pollutants that negatively affect human health and cause the acidification of the environment [26], [27].

In the maritime sector, SO_x and NO_x emissions are controlled based on the navigation area of a ship, i.e. whether the ship navigates in the global area or it operates in Emission Control Areas (ECAs), in which emissions requirements are stricter than out-side these areas [28]. While SO_x emission is limited with the allowed content of sulfur in fuel, NO_x emission are regulated depending on the engine’s maximum operating speed [29].

In order to cope with the increasing GHGs emissions, International Maritime Organization (IMO) set a goal according to which international shipping needs to reduce at least 50% of their released GHGs by 2050, compared to 2008. levels [30]. The IMO decarbonization strategy defines three levels of measures to achieve the required GHGs reduction goal: short-term, mid-term and long-term measures [31], Figure 6.

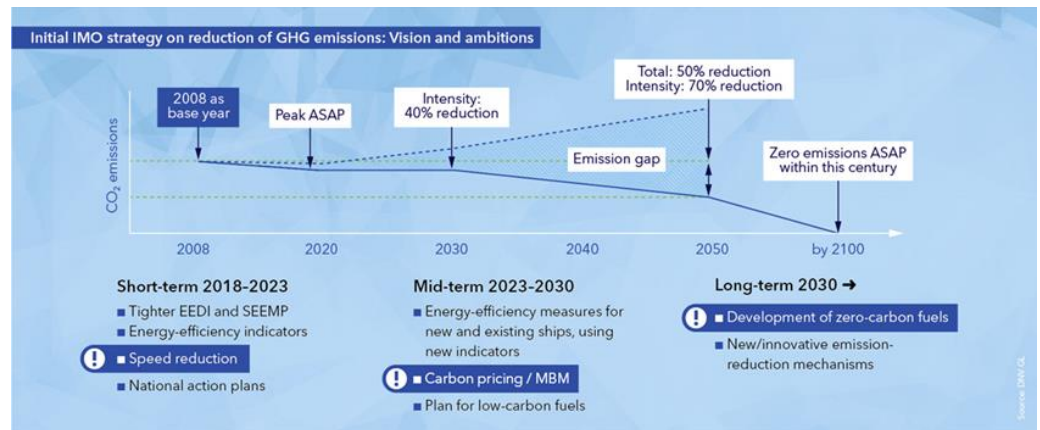

Figure 6. The IMO strategy for the reduction of GHG emissions (reproduced from [31] with permission of Det Norske Veritas (DNV), 2022)

The short-term measure (2018 - 2023) refer to Energy Efficiency Design Index (EEDI) and Ship Energy Efficiency Management Plan (SEEMP) as well as to the implementation of an operative measure of speed reduction. The mid-term decarbonization ambition (2023-2030), among others, includes a measure of increasing the energy efficiency for new and existing ships [31] and the Energy Efficiency Design Index of Existing ships (EEXI) that will be set in on force on 01 January 2023 [32]. Other mid-term measures are the implementation of Market-Based Measures (MBMs), such as emission pricing policy, and replacing conventional marine fuels with low-carbon fuels. For the long-term goal (2030 -), the implementation of zero-carbon fuels (hydrogen, ammonia, electricity, biofuels) and innovative emission reduction technology is required [31]. In addition to GHGs reduction, the replacement of fossil fuels with zero-carbon fuels will result in the reduction of other pernicious emissions. The ultimate goal of long-term ambition is the zero-emissions powered ships by the end of the century. Decarbonization measures are summarized in Figure 7.

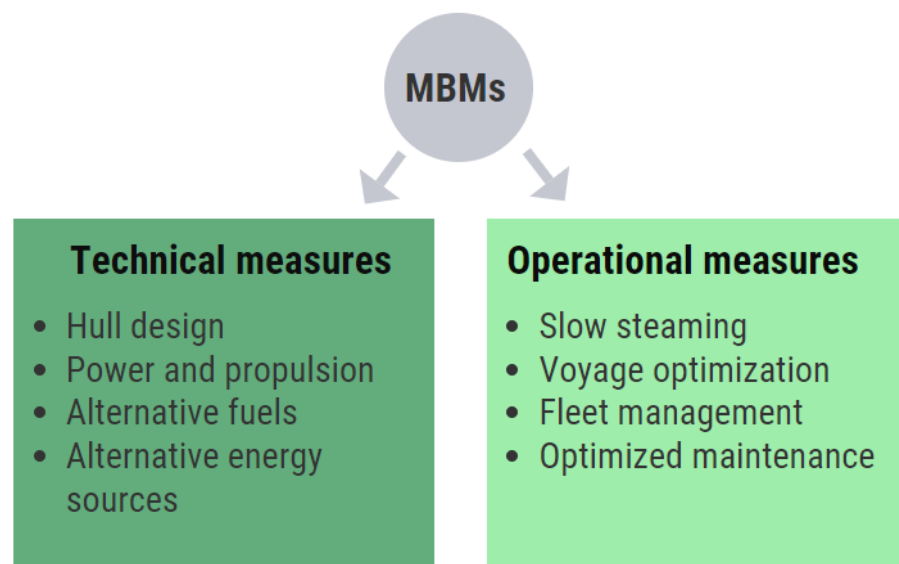

Figure 7. Decarbonization measures

Within the existing ship power system design procedure, the environmental requirements that will be in force in the next 20-30 years need to be considered, and according to them, implement a proper power system. Since the Mediterranean Sea is currently investigated as a potential ECA [33], and that there are some specific areas with local

regulations, such as Marseille port in southern France which intends to become the Mediterranean’s 1st Fully Electric Port by 2025 [34], the ships of the future intended to operate in this area should be designed to cope with these requirements.

2.2.3. Comfort requirements

Noise and vibration problems are inherent to all ships due to a number of engines and devices needed for their operation. The main noise sources in ships are the following: main engine and generator sets, gearboxes, propellers, exhaust systems with engine room ventilation, auxiliary mechanism such as hydraulic systems, pumps, ventilation and air-conditioning systems, side thrusters, etc., Figure 8.

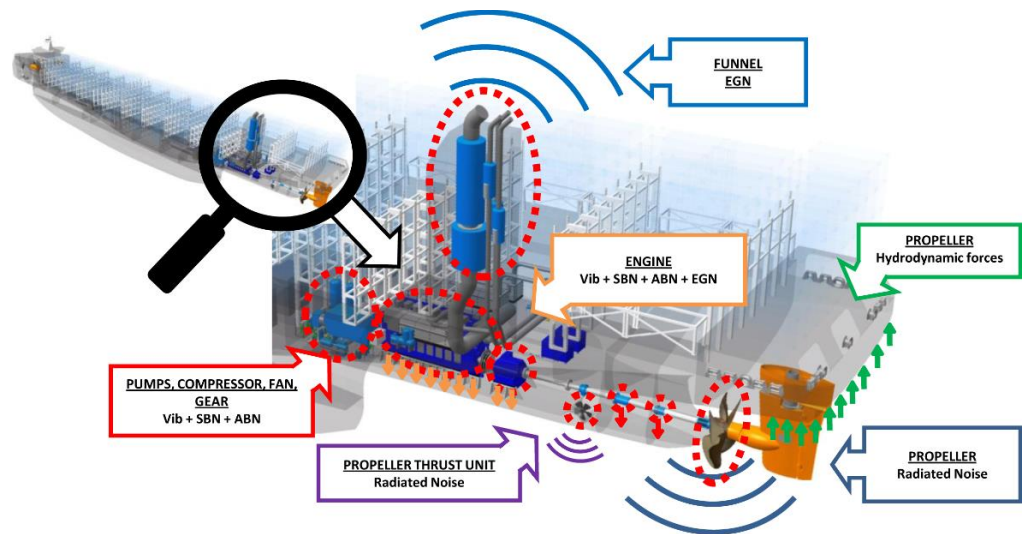

Figure 8. Main noise sources on board [35]

Passenger comfort is significant for the evaluation of the ship in the market and in last decades it represents important contractual point, subject to heavy penalties when the required comfort class is not fulfilled [36]. The comfort ratings for passenger accommodation differ from one classification society to another, and some selected values are shown in Table 1, where (1) reflects to high, while (3) denotes acceptable.

Table 1. Sound pressure levels (dB(A)) in passenger accommodation [36]

Location	DNV			BV			LR	
	CRN(1)	CRN(2)	CRN(3)	1	2	3	1	2
Top grade	44	47	50	45	50	50	45	50
Standard cabins	49	52	55	50	55	55	45	50
Public rooms	55	58	62	55	60	65	55	60
Open decks	65	65	70	65	70	75	65	70

Reduction of noise can be generally achieved by active and passive methods, and in the shipbuilding passive methods like insulation, are common approaches.

To ensure that passengers are not disturbed by usual activities in the adjacent cabins, regularly passive noise reduction methods are applied, i.e. fitting the sound insulations. The comfort class criteria related to sound insulation (expressed in Weighted Sound Reduction Index or R_w) are shown in Table 2.

Table 2. Comfort class criteria related to sound insulation R_w (dB) [36]

Location	DNV	BV	LR
Between top grade cabins	46	42	45
Between standard cabins	41	40	45
Between cabins and standard public rooms	55	55	55
Between cabins and show rooms	65	65	-

In [36] one can find the minimum added weight (expressed in kg/m²) to meet the sound indexes required between cabins and specific public spaces, according to the classification societies.

Class notations are assigned to vessels in order to determine applicable rule requirements for assignment and retention of class. In addition to the interior noise requirements described above, there is additional class notation called SILENT, which refers to the ship environmental footprint (underwater noise emission).

Similarly to noise, classification societies have vibration standards associated with the comfort class notation, Table 3.

Table 3. Maximum allowable values of vibration (mm/s) for selected spaces according to different classification societies

Location	DNV				LR				BV							
	1	2	3	Av.	1	2	3	Av.	For ships less than 1600 GT				For ships ≥ 1600 GT			
									1	2	3	Av.	1	2	3	Av.
Passenger cabin, standard	1.5	2.0	3.0	2.2	1.8	2.1	2.4	2.1	3.0	3.5	4.0	3.5	2.8	3.0	3.2	3.0
Passenger cabin, superior	1.5	1.5	2.0	1.7	1.5	1.8	2.1	1.8					1.7	2.0	2.2	2.0
Public spaces	1.5	2.0	3.0	2.2	2.0	2.5	3.0	2.5	3.0	4.0	5.0	4.0	3.0	3.5	4.0	3.5
Open deck recreation	2.0	2.7	3.5	2.7	2.5	3.0	3.5	3.0								
Crew cabins									3.0	3.5	4.0	3.5				
Mess rooms									3.0	4.0	5.0	4.0	3.0	3.5	4.0	3.5
Offices									3.0	4.0	5.0	4.0	3.0	3.5	4.0	3.5
Open public areas									4.0	6.0	6.0	5.3				
ECR, switchboard room									4.0	6.0	6.0	5.3	4.0	5.0	6.0	5.0
Work places					5.0	5.0	5.0	5.0	4.0	6.0	6.0	5.3	5.0	5.5	6.0	5.5

The rules do not cover every piece of structure or item of equipment on board a vessel, nor do they cover operational elements. Activities which generally fall outside the scope of classification include such items as: design and manufacturing processes; choice of type and power of machinery and certain equipment; number and qualification of crew or operating personnel; form and cargo carrying capacity of the ship and maneuvering performance; hull vibrations; spare parts; life-saving appliances and maintenance equipment. These matters may however be given consideration for classification according to the type of ship or class notations assigned. Det Norske Veritas, Lloyd’s Register and Bureau Veritas are taken as a reference because they were the first to develop Comfort Class

notations and therefore are most common and widespread in naval market with respect to this issue. In Table 3 the criteria (requirements) from the mentioned classification societies will be reviewed and compared.

One of the approaches of controlling and better understanding of noise and vibration is the so-called Source – Path – Receiver model, Figure 9.

This theoretical model is used to examine the problem by breaking down the unit into three basic elements: the Source of noise and vibration, the conveying medium or so-called Path, and the Receiver. By recognizing these elements we can see that noise and vibration can be controlled by altering any of these three elements.

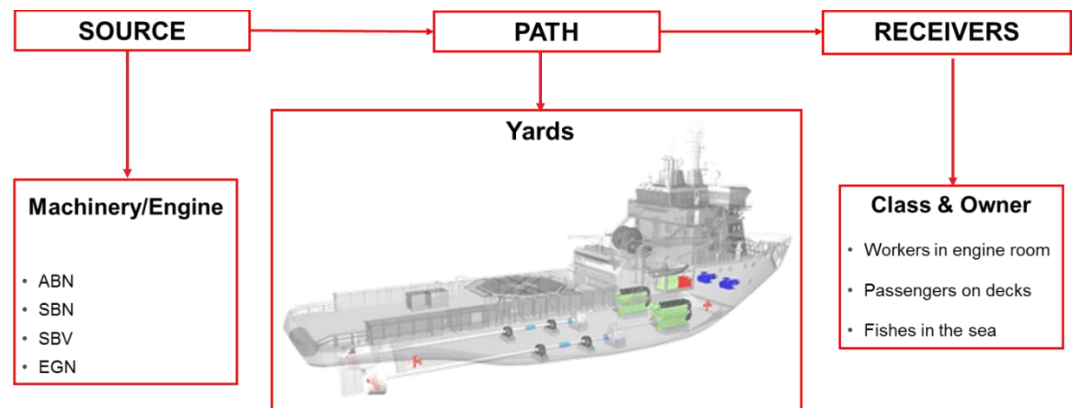

Figure 9. Source-Path-Receiver model

3. Materials and methods

3.1. Hull definition

Hydrodynamic analysis concerning a particular hull form can range from the simplest models involving only multiple ship parameters (e.g. length, breadth, draft, block coefficient etc.) to the more complex direct numerical simulations. Numerical models can also differ significantly in their underlying fluid mathematical model. Regardless of the model, the most important factor is the accurate estimation of the ship resistance which leads to the reliable estimations of the necessary engine power. In this work, state-of-the-art numerical model in ship resistance is employed. Numerical model is based on the Computational Fluid Dynamics (CFD) with the Finite Volume (FV) space discretization. Viscosity and turbulence is included in the ship free-surface simulations. The simulations are performed for different speeds, thus obtaining the ship resistance curve for various Froude numbers. Simulations are performed by means of OpenFOAM [37] in a dedicated in-house naval library [38]. Computed ship resistance (R_t) is further used for the estimation of the required engine power as follows:

- Added resistance from wind loads (10%) and appendages (10%) is estimated at 20% R_t total.
- Effective propulsive power (P_E) is computed for the selected ship speed (V).
- Delivered power (P_D) to the shaft is computed using the average fixed pitch propeller efficiency of 60%.
- Brake power (P_B) includes additional 25% for various consumers (accommodation etc.) for passenger ship.
- Engine MCR is usually set at 85% which leads to the estimation of installed engine power (P_{MCR}).

Apart from the engine power estimation, important aspect in ship design is the ship stability evaluation. Detailed stability calculations involve entire ship structure and masses onboard along with the different loading conditions. In this work, only an illustrative example is given, so the centre of gravity is approximated at even keel inline with

the centre of buoyancy for given condition. Vertical centre of gravity is set at a percentage of ship height common to similar built ships. The righting lever (GZ) curve is computed for a single load case and compared to the necessary stability criteria.

Results in Figures 4 and 5 indicate that there is relatively high scattering between dimensions and total installed power of passenger ships in the Mediterranean. One of the reasons for this is the fact that considered data do not consider ship mission. Therefore, no single option can be selected in the definition of hull module. For this reason, a generic hull model is employed with variable stern, fore and mid-section depending on the project needs, Figure 10 shows the used hull modules which are adjusted accordingly and will be further defined depending on the design task. Within this paper, detailed results on the hull with a length of 45.0 m are included.



Figure 10. Hull modules used within the proposed design procedure (fore, mid and stern modules).

3.2. Power system





In this paper, the focus is put on the implementation of technical measures, hull design, but also on the replacement of conventional power systems with alternative ones. Future emission requirements force the shipping industry to move toward the implementation of alternative and cleaner fuels. Their application needs to be investigated from the environmental and economic points of view, where the baseline scenario is the currently used diesel-powered ship.

In order to establish a basis for the selection of appropriate power system module, the environmental impact of a range of power systems with potential for applicability in passenger ships, Table 4, is analyzed by performing the Life-Cycle Assessment (LCA) by means of GaBi Academy software [39]. According to LCA guidelines of ISO 14040 [40] and ISO 14044 [41], performing LCA requires the definition of goal and scope of the assessment, functional unit, system boundary and inventory. In this paper, the LCA investigates the environmental eligibility of different alternative fuels implemented on a small passenger ship. A ton of released GHGs expressed in unit of CO₂-eq represents the functional unit, while the inventory data is obtained from GaBi Academy databases. The system boundary is placed on the ship power system, where GHG emissions related only to the production of fuel (Well-to-Pump (WTP) phase, which includes processes from raw materials extraction and its transportation to the production facility, production of specific fuel and distribution to the ship), use of fuel (Pump-to-Wake (PTW) and manufacturing the main element of the system (Manufacturing (M) phase) are considered. For example, when analysing a diesel-powered ship that serves as a baseline scenario, processes included in the LCA of this power system configuration are crude oil extraction and transportation to the production site, production of diesel and its distribution via tank trucks to the refuelling station near the port, combustion of diesel in a diesel engine during ship operation, and manufacturing process of a diesel engine. The economic analysis is performed with the Life-Cycle Cost Assessment (LCCA), in which the investment, fuel and maintenance cost are investigated during the ship lifetime, i.e. 20 years of its exploitation [42].

The details about selected power system configurations from Table 4 are explained in the author's previous papers [42], [43], [44], [45], [46].

Table 4. Ship power system configurations [42], [43], [47], [48]

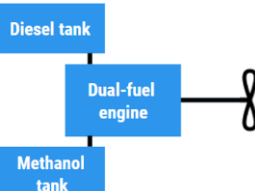
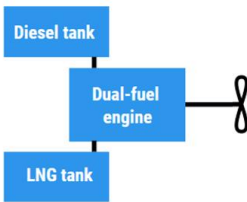
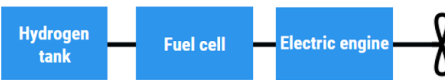
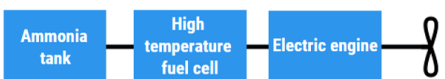
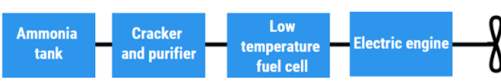
386
387

Ship power system configurations			
Fuel	Simplified scheme	Advantages	Drawbacks
Diesel		<ul style="list-style-type: none"> well-known technology used in most of the vessels low fuel price 	<ul style="list-style-type: none"> fossil fuel with high carbon content of 87%
Electricity		<ul style="list-style-type: none"> enable zero-emission shipping high efficiency 	<ul style="list-style-type: none"> limited to short-range coastal vessels high capital cost
Methanol		<ul style="list-style-type: none"> carbon content of 38% available and affordable fuel-grey methanol integration into existing infrastructure with minor modifications 	<ul style="list-style-type: none"> toxic fuel potential leakage can have impact on sea life high production cost-green methanol
LNG		<ul style="list-style-type: none"> competitive fuel price available infrastructure and technology high-energy density already used globally 30% lower GHGs compared to fuel oil 	<ul style="list-style-type: none"> fossil fuel storage issues (insulated tanks at -162°C)
Hydrogen		<ul style="list-style-type: none"> enable zero-emission shipping (in a fuel cell) 	<ul style="list-style-type: none"> storage issues absence of supply and bunkering infrastructure high costs flammability risk
Ammonia		<ul style="list-style-type: none"> carbon-free fuel applicable in internal combustion engines and fuel cells affordable fuel-grey ammonia 	<ul style="list-style-type: none"> high toxicity-requires safety measures high operative costs-green ammonia current production of grey ammonia generates high amount of GHGs
			
Biodiesel-diesel blend		<ul style="list-style-type: none"> easy integration in current engines the share of biodiesel up to 20% requires no engine modifications 	<ul style="list-style-type: none"> production biodiesel from edible biomass can result in food crisis blend combustion results in GHGs

3.3. Design of the superstructure module with respect to comfort standards

Although the noise and vibration problems are usually considered simultaneously, the methods for their prediction and measurements are fundamentally different, because they are related to the completely different frequency ranges (noise is in the audible range above 30 Hz and is evaluated in decibels). The noise consists of two parts which are transmitted through two different transmission paths. In this sense, we distinguish airborne and structure borne path, transmitted through the air and structure, respectively. Regularly, noise and vibration levels on board are measured at ship delivery, and if problems are detected, they should be remedied in order to achieve vessel compliance with the prescribed values. In spite of variety of noise abatement methods, elimination of such problems at the delivery stage becomes rather expensive, and therefore it is desirable to predict noise levels in the preliminary stage.

For noise assessment, the hybrid Statistical Energy Analysis (SEA) seems to be reasonable choice, due to its simplicity and acceptable accuracy (particularly in high frequency domain), [49]. Within the proposed approach passive noise reduction methods applied, where mainly transmission paths is influenced, Figure 9. By means of DesignerNOISE tool [50], series of passenger compartments, Figure 11, are investigated with different insulation materials and insulation thicknesses, where also the price is considered in order to provide guidance to the designer on the selection of the most appropriate one for the target comfort class, Figure 12.

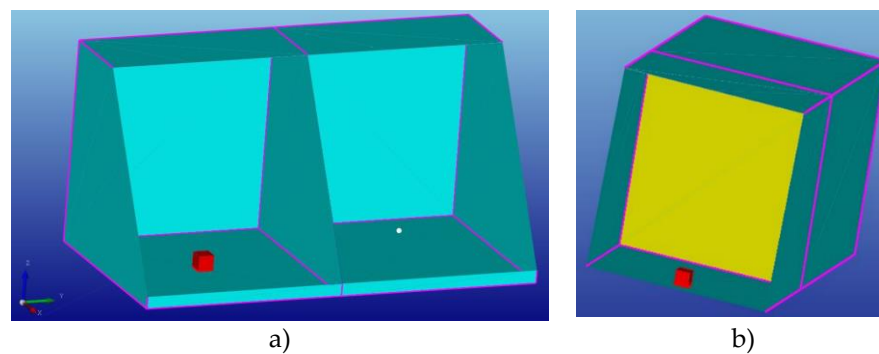

Figure 11. a) Two adjacent compartments with noise source and receiver, b) insulated bulkhead between passenger spaces

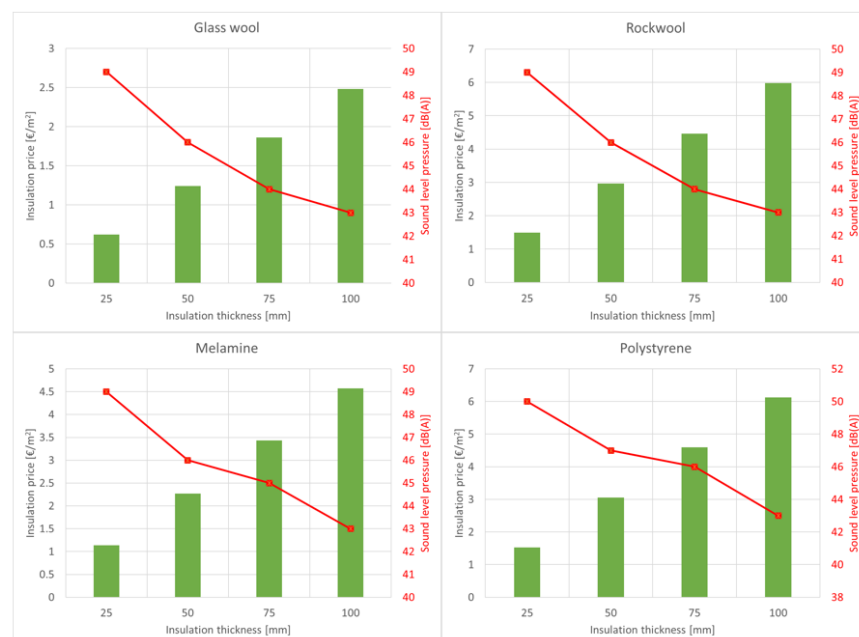

Figure 12. Noise reduction potential of different materials and specific prices

Prices of different materials are compared in, Figure 13, while comparison of the noise reduction potential f different materials is shown in Figure 14.

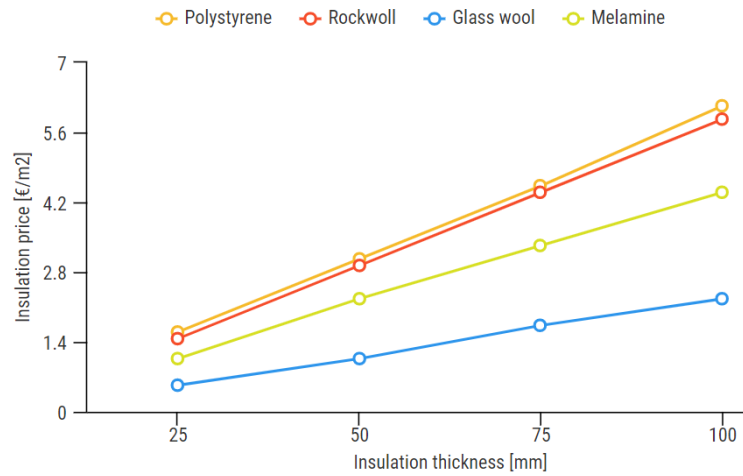

Figure 13. Comparative analysis of prices for different insulation materials

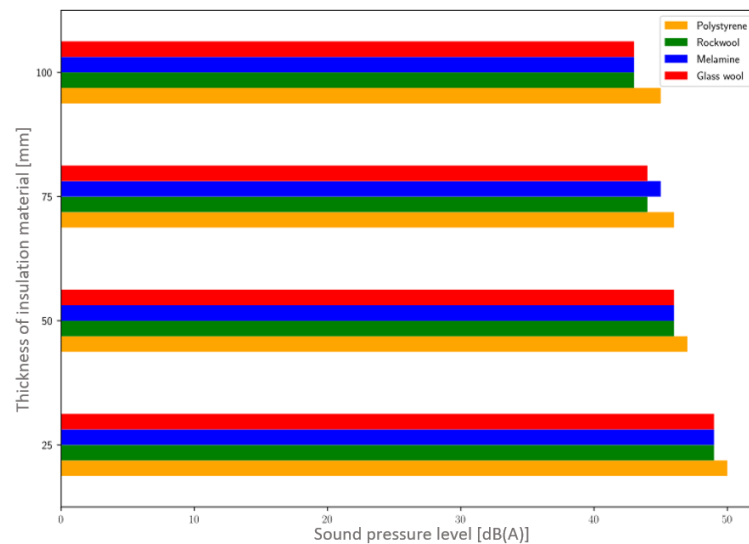

Figure 14. Noise levels at the receivers for different insulation materials

Beside noise, vibration also plays an important role in the ship comfort. In case of vibration, it is generally accepted opinion that great benefits can be achieved if vibration reduction at the source is possible.

Interaction between the source represented and the receiver in case of vibration can be represented by the following equation:

$$S \cdot e \cdot q_E = l \tag{1}$$

where location l represents vibration velocity that is required by while classification societies, while e specifies maximum excitation force induced by the engine. By implementing different technologies on the source (engine), its quality can be changed in order to mitigate and control vibration transmission. This is denoted as engine quality q_E , and this quantity is directly related to the costs. Regularly, the engine excitation e is known from the producer, quality of the engine q_E is represented as a percentage decrease of vibratory response (from 0.1 to 1.0), and the location l is defined as vibration velocity, and all that has to be done is to calculate the ship's transfer function S . It is necessary to

investigate the transfer function S in combination with different engines and their excita- 437
 tions that eventually leads to the same vibration velocity at certain location at the ship. An 438
 illustration of this approach can be seen in Figure 15. Different comfort classes are repre- 439
 sented by the comfort rating number (crn), where level 1 (yellow curve) is better solution 440
 in comparison with 2 (blue curve) which represents lowest comfort level. As can be no- 441
 ticed in Figure 15, if one wants to shift from crn=3 to crn=2 or 1, the engine quality should 442
 increase, which necessarily leads to additional costs. 443
 444

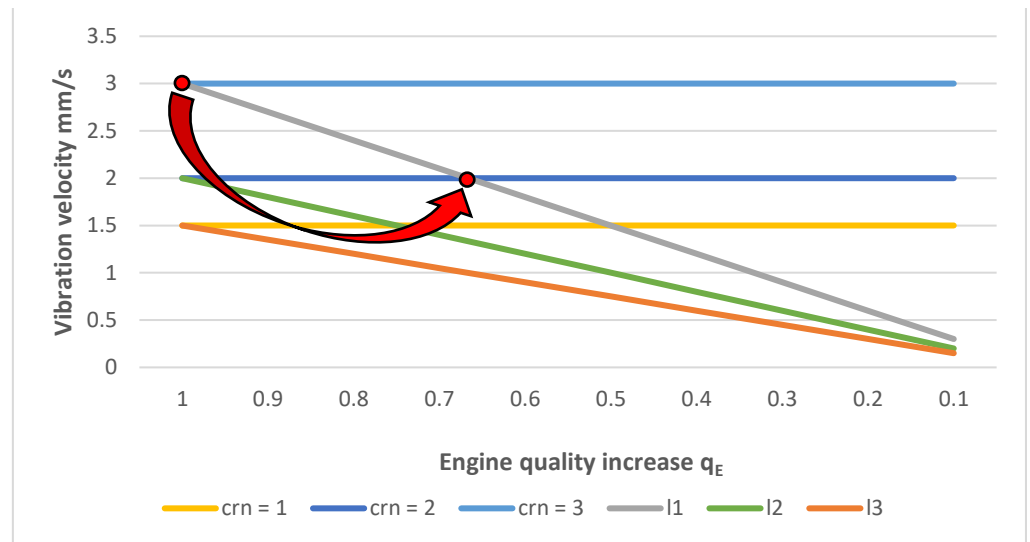

Figure 15. Vibratory response at passenger spaces depending on ship transfer functions 445
 and shifting to higher comfort level 446
 447
 448

4. Illustrative example 449

Within this illustrative example, a pre-defined solution (concept-design) of a passen- 450
 ger vessel having LOA of 45.0 m and capacity 250 passengers is described. 451

4.1. Hydrodynamic results 452

Ship hull analyzed in this study is a generic passenger ship model which satisfies an 453
 exemplary design task for length, breadth, number of passengers etc. Parameters of the 454
 design task i.e. ship particulars studied in this work, are given in Table 5. 455

Hydrodynamic results for resistance are computed in CFD for various ship speeds. 456
 Example of the simulation and computational mesh is shown in Figure 17. Results for 457
 resistance curve are shown in Figure 18. Following the estimation method for the engine 458
 power explained in Section 3.2. the design speed power requirements can be calculated 459
 using the towing resistance force. Engine requirement for this hull design is equal to 840 460
 kW. In order to take into account auxiliary power needs, the main ship power needs are 461
 increased by 25%. 462
 463
 464
 465

Table 5. Ship particulars 466

Ship particulars		
Length overall (L_{OA})	45.0	m
Length waterline (L_{WL})	42.3	m
Breadth (B)	9.0	m
Draft (T)	3.0	m

Design speed (V_s)	14	kn
Number of passengers	250	
Block coefficient (C_B)	0.45	
Wetted surface (A)	425.2	m^2
Displacement (Δ)	521.3	t

467

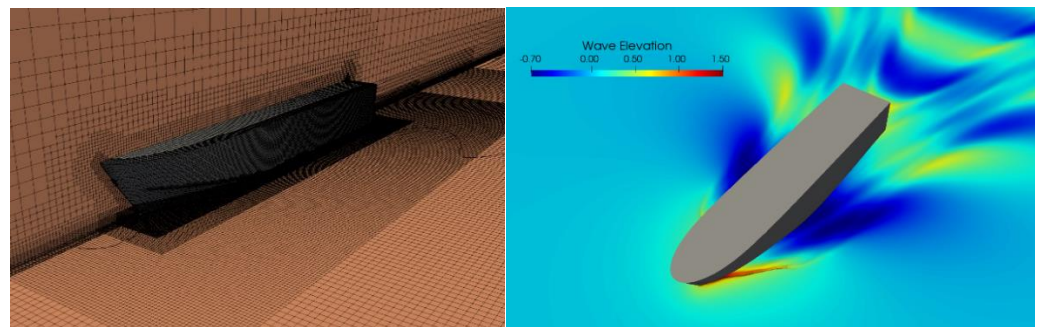

468

Figure 17. Computational mesh and free surface at ship design speed ($V=14$ kn).

469

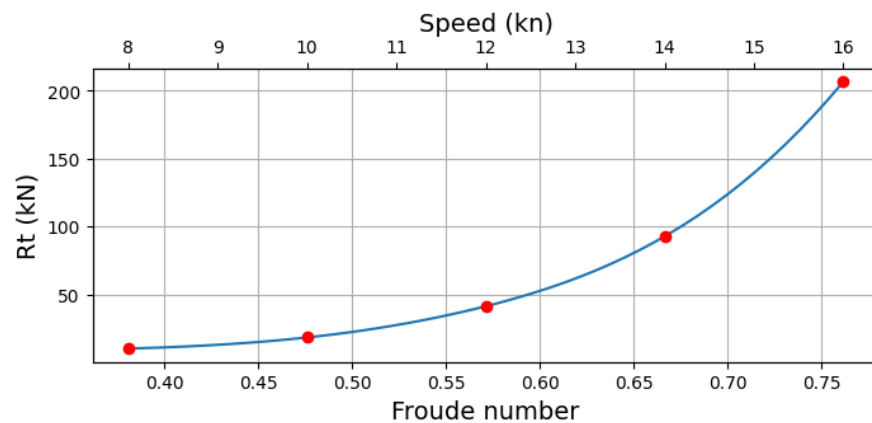

470

Figure 18. Resistance curve computed in CFD.

471

Stability calculations are performed only for the preliminary design with a single loading condition (design condition). The ship superstructure is not defined in detail since it requires design of the accommodation cabins, and the ship masses are not exactly specified at this design stage meaning that the ship center of gravity is only approximated. The righting lever curve is shown in Figure 19. Rules for the GZ curve are based on the IMO stability regulations for passenger ships and here only the basic rules for intact stability are checked and are satisfied.

472

473

474

475

476

477

478

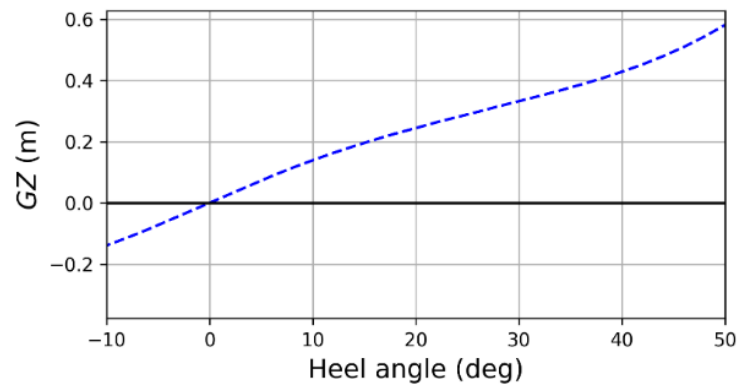

Figure 19. Righting lever curve (GZ) for design draft.

4.2. Ship power system selection

The LCA and LCCA results of the investigated ship are presented in Figure 20 where D denotes diesel, E denotes electricity, M refers to methanol, H refers to hydrogen used in a Proton Exchange Membrane Fuel Cell (PEMFC), A refers to ammonia used in PEMFC, while BD refers to the biodiesel-diesel blend B20.

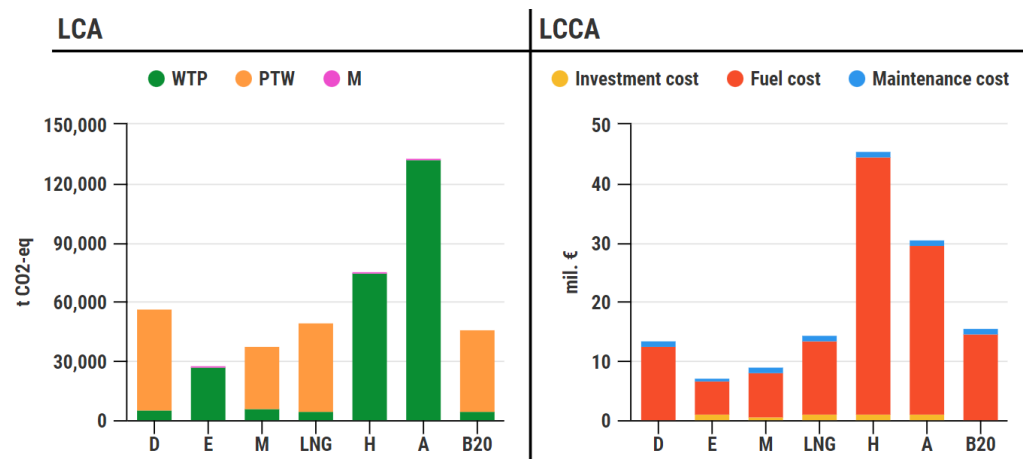

Figure 20. A comparison of the LCA and LCCA of alternative fuels

The results of the environmental and economic analysis indicated that the full electrification with only a battery represents the most environmentally friendly and most cost-effective powering options among those considered.

4.3. Superstructure

Typical superstructure spaces are recommended to be insulated by a glass wool, since it offers optimal solution for sound insulation with respect to weighted sound reduction index and the price. However, in a later design stage, when the ship is defined more precisely, the noise prediction should be performed again, Figure 21, and if noise prediction is encountered, special treatments should be done.

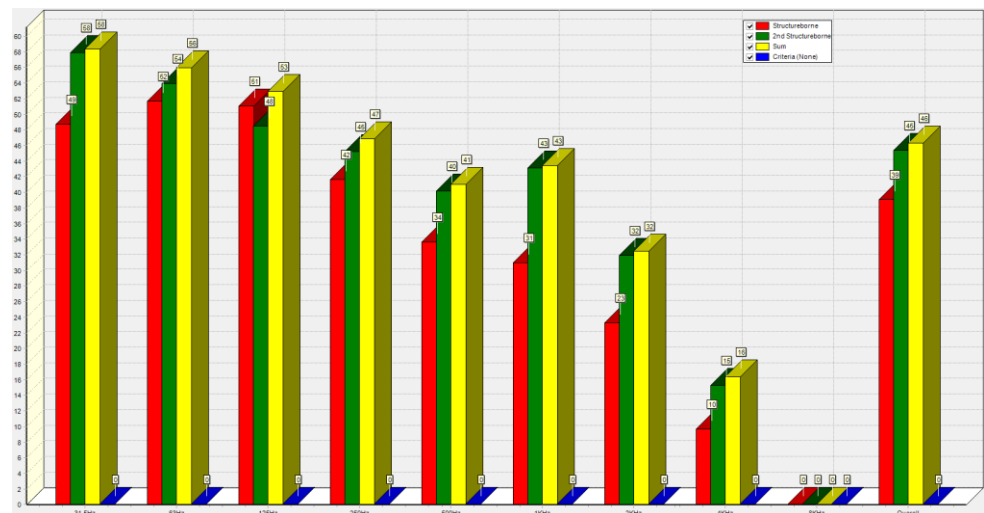

Figure 21. Typical results of noise prediction for ship compartments

It should be mentioned that LCA and LCCA assessment suggested electrification of power system as a desirable option. This leads to excellent noise and vibration performance at the level of excitation source according to Source – Path – Receiver model, Figure 9. By selection of environmentally friendly options of power systems, therefore, benefits for comfort level can be achieved.

5. Concluding remarks

In this paper, the modular approach in the design of small passenger ships for the Mediterranean is illustrated, where the ship is virtually assembled from three predefined modules. The approach concept design phase, Figure 1, where there is still relatively high design uncertainty, i.e. the design task is not fully defined and there is design freedom to alternate number of ship details. Modules of different environmental friendliness and habitability class are pre-defined and are interchangeable and adaptable to a series of ship hull, forming concept design of different quality and price. As such, pre-defined solutions for ship hull, power system module and superstructure form reasonable basis for definition of detailed design requirements, and based on that, the price breakdown can be made. Within the proposed approach, sophisticated analysis tools are integrated in the design loop. This approach particularly addresses environmental and comfort aspects, which nowadays belong to the most important issues in ship design.

The main findings of the paper can be summarized as follows:

- Small passenger ships in Mediterranean significantly differ in dimensions, power needs, propulsor type, etc., but most of them, however, utilize diesel-engine-powered propulsion,
- Environmental and comfort criteria are important design aspects of future ships,
- Environmentally-friendly solutions in ship power system can result in comfort benefits,
- Pre-defined solutions represent useful tool for conceptual design, particularly for small shipyards which can not invest huge resources in research and development,
- Pre-defined solutions should be further optimized, as design freedom reduces,
- Presented concept can be extended to the arbitrary number of modules (depending on the market needs), making the procedure more robust and faster to obtain pre-defined solutions.

The proposed approach did not include structural issues. Since the global strength is regularly not a critical issue for smaller ships, structural issues should be considered within the local strength assessment, in further design stages where more information on the structure are known.

Although the procedure is focused on small passenger ships for Mediterranean, the approach can be generalized by involving any other set of vessels in the fleet analysis and by considering regulatory framework for other areas worldwide.

Author Contributions: For research articles with several authors, a short paragraph specifying their individual contributions must be provided. The following statements should be used “Conceptualization, N.V., A.B. and M.P.; methodology, N.V. and A.B.; software, A.B., M.P. and I.J.; validation, A.B., M.P., and I.J.; formal analysis, N.V., A.B. and M.P.; investigation, N.V., A.B., M.P. and I.J.; resources, N.V.; data curation, I.J.; writing—original draft preparation, N.V.; writing—review and editing, A.B., M.P. and I.J.; visualization, A.B., M.P. and I.J.; supervision, N.V.; project administration, N.V.; funding acquisition, N.V. All authors have read and agreed to the published version of the manuscript.” Please turn to the CRediT taxonomy for the term explanation. Authorship must be limited to those who have contributed substantially to the work reported.

Funding: This research was funded by the Croatian Science Foundation under the project Green Modular Passenger Vessel for Medi-terranean (GRiMM), (Project No. UIP-2017-05-1253). Maja Perčić, a Ph.D. student, is supported through the “Young re-searchers’ career development project – training of doctoral students” of the Croatian Science Foundation, funded by the European Union from the European Social Fund (ESF). Ivana Jovanović, a Ph.D. student is supported through the “Young re-searchers’ career development project – training of doctoral students” of the Croatian Science Foundation.

Conflicts of Interest: The authors declare no conflict of interest.

References

1. Gelesz, P.; Karczewski, A.; Kozak, J.; Litwin, W.; Piatek, L. Design methodology for small passenger ships on the example of the ferryboat Motlawa 2 driven by hybrid propulsion system. *Polish Maritime Research* **2017**, *24*, 67-73.
2. Gianni, M.; Bucci, V.; Marino, A. System simulation as decision support tool in ship design. *Procedia Computer Science* **2021**, *180*, 754-763.
3. Zwaginga, J.; Stroo, K.; Kana, A. Exploring market uncertainty in early ship design. *International Journal of Naval Architecture and Ocean Engineering* **2021**, *13*, 352-366.
4. Andrews, D. A comprehensive methodology for the design of ships (and other complex systems). *Proc. R. Soc. Lond. Ser. A: Math. Phys. Eng. Sci.* **1998**, *454*, 187-211.
5. Shields, C.P.; Singer, D.J.: Naval design, knowledge-based complexity, and emergent design failures. *Naval Engineers Journal* **2017**, *129*, 75-86.
6. Mckenney, T.A.: An early-stage set-based design reduction decision support framework utilizing design space mapping and a graph theoretic Markov decision process formulation. Ph.D. Thesis, University of Michigan, USA **2013**.
7. Karczewski, A.; Kozak, J. Variant designing in the preliminary small ship design process, Polish Maritime Research. *Polish Maritime Research* **2017**, *24*, 77-82.
8. Ao, Y.; Li, Y.; Gong, J.; Li, S. An artificial intelligence-aided design (AIAD) of ship hull structures. *J. Ocean Eng. Sci.* **2021**, doi.org/10.1016/j.joes.2021.11.003.
9. Priftis, A.; Boulougouris, E.; Turan, O.; Atzamos, G. Multi-objective robust early stage ship design optimisation under uncertainty utilising surrogate models. *Ocean Eng.* **2020**, *197*, 106850.
10. Cook, R.L.: The impact of modular ship design on the life cycle of naval vessel, Master thesis, Massachusetts Institute of Technology (MIT), USA **1976**.
11. Erikstad, S.O.: Modularisation in shipbuilding and modular production, Innovation in Global Maritime Production, Norwegian University of Science and Technology (NTNU), Trondheim, Norway **2009**.
12. Jollif, J.V.: Modular ship design concepts. *Naval Engineers Journal* **1974**.
13. Bertram, V. Modularization of ships, Report within the Framework of Project “Intermodul” s/03/G Intermare C, ENSIETA, France, **2005** (available at www.cto.gda.pl, accessed November 11, 2019).
14. Tvedt, H. Modular approach to offshore vessel design and configuration, Master thesis, Norwegian University of Science and Technology (NTNU), Trondheim, Norway, **2012**.
15. Misra, S.C., Sha, O.P.: Modularization – A tool for production friendly ship designs, World Maritime Tech Conference, Mumbai, India, **2009**.
16. Damen. <https://www.damenmodularbarges.com/>, (accessed September 20, 2019).

17. Nam, T.; Mavris, D. Multi-stage reliability-based design optimization for aerospace system conceptual design. In: 49th AIAA/ASME/ASCE/AHS/ASC Structures, Structural Dynamics, and Materials Conference, Schaumburg, Illinois, USA, 2012, <https://doi.org/10.2514/6.2008-2073>. 595
18. NavCad. <https://www.hydrocompinc.com/solutions/navcad/>, (accessed December 01, 2018). 596
19. IHS Fairplay: World register of ships—WROS manual, 2015. 597
20. <https://www.fsb.unizg.hr/kmb/100/110/kmb111.htm> (accessed April 05, 2017). 598
21. United Nations Framework Convention Climate Change (UNFCCC). Climate Change Information kit. <https://unfccc.int/resource/iuokit/cckit2001en.pdf>, (accessed January 14, 2021). 599
22. Bataille, C.; Åhman, M.; Neuhoff, K.; Nilsson, L.J.; Fischedick, M.; Lechtenböhmer, S.; et al. A review of technology and policy deep decarbonization pathway options for making energy-intensive industry production consistent with the Paris Agreement. *Journal of Cleaner Production* 2018, 187, 960–73. 600
23. UNFCCC. The Paris Agreement. <https://unfccc.int/process-and-meetings/the-paris-agreement/the-paris-agreement>, (accessed November 03, 2021). 601
24. Odeh, N.A.; Cockerill, T.T. Life cycle GHG assessment of fossil fuel power plants with carbon capture and storage. *Energy Policy* 2008, 36, 367–80. 602
25. Monteiro, A.; Russo, M.; Gama, C.; Borrego, C. How important are maritime emissions for the air quality: At European and national scale. *Environmental Pollution* 2018, 242, 565–75. 603
26. Sofiev, M.; Winebrake, J.J.; Johansson, L.; Carr, E.W.; Prank, M.; Soares, J.; Vira, J.; Kouznetsov, R.; Jalkanen J.-P.; Corbett J.J. Cleaner fuels for ships provide public health benefits with climate tradeoffs. *Nature Communications* 2018, 9(1), 406. 604
27. Kim, T.; Chae, C. Environmental Impact Analysis of Acidification and Eutrophication Due to Emissions from the Production of Concrete. *Sustainability* 2016, 8, 578. 605
28. Chen, L.; Yip, T.L.; Mou, J. Provision of Emission Control Area and the impact on shipping route choice and ship emissions. *Transportation Research Part D: Transport and Environment* 2018, 58, 280–291. 606
29. Emission Standards: IMO Marine Engine Regulations. <https://dieselnet.com/standards/inter/imo.php#s>, (accessed November 1, 2020). 607
30. International Maritime Organization. Fourth IMO GHG study-Final report 2020. <https://safety4sea.com/wp-content/uploads/2020/08/MEPC-75-7-15-Fourth-IMO-GHG-Study-2020-Final-report-Secretariat.pdf>, (accessed January 14, 2021). 608
31. DNV. Achieving the IMO decarbonization goals. <https://www.dnv.com/expert-story/maritime-impact/How-newbuilds-can-comply-with-IMOs-2030-CO2-reduction-targets.html>, (accessed June 24, 2021). 609
32. DNV. Energy Efficiency Existing Ship Index (EEXI). <https://www.dnv.com/maritime/insights/topics/eexi/index.html>, (accessed October 14, 2021). 610
33. Regional Marine Pollution Emergency Response Centre for the Mediterranean Sea. Med SO_x ECA. <https://www.rem-pec.org/en/our-work/pollution-prevention/hop-topics/med-eca/med-sox-eca-introduction>, (accessed October 27, 2021). 611
34. Offshore Energy. Marseille Fos - the Mediterranean's 1st Fully Electric Port by 2025. <https://www.offshore-energy.biz/marseille-fos-wants-to-be-mediterraneans-1st-fully-electric-port-by-2025/>, (accessed October 21, 2021). 612
35. Tudor, H. Techno-economic assessment of new marine engine development with high noise and vibration performance. Master Thesis, UNIZAG FSB, Zagreb, Croatia, 2017. 613
36. Blanchet, A.: Comfort class and passenger ships. InterNOISE Conference, Nice, France, 2000. 614
37. Weller, H. G.; Tabor G.; Jasak H.; Fureby C.; A tensorial approach to computational continuum mechanics using object oriented techniques, *Computers in Physics* 1998, 12, 620–631. 615
38. Vukčević, V. Numerical modelling of coupled potential and viscous flow for marine applications. Faculty of Mechanical Engineering and Naval Architecture, University of Zagreb, 2016. 616
39. GaBi Academy. LCA software. <https://gabi.sphera.com/international/software/gabi-universities/gabi-academy/>, (accessed December 12, 2021). 617
40. ISO 14040. <https://www.iso.org/standard/37456.html>, (accessed 05 January, 2022). 618
41. ISO 14044. <https://www.iso.org/standard/38498.html>, (accessed 05 January, 2022). 619
42. Perčić, M.; Vladimir, N.; Fan, A. Life-cycle cost assessment of alternative marine fuels to reduce the carbon footprint in short-sea shipping: A case study of Croatia. *Applied Energy* 2020, 279, 115848. 620
43. Perčić, M.; Vladimir, N.; Fan, A. Techno-economic assessment of alternative marine fuels for inland shipping in Croatia. *Renewable and Sustainable Energy Reviews* 2021, 148, 111363. 621
44. Perčić, M., Vladimir, N., Koričan, M. Electrification of inland waterway ships considering power system lifetime emissions and costs. *Energies* 2021, 14 (21), 7046. 622
45. Perčić, M., Ančić, I., Vladimir, N. Life-cycle cost assessments of different power system configurations to reduce the carbon footprint in the Croatian short-sea shipping sector. *Renewable & sustainable energy reviews* 2020, 131, 110028. 623
46. Fan, A., Wang, J., He, Y., Perčić, M., Vladimir, N., Yang, L. Decarbonising inland ship power system: Alternative solution and assessment method. *Energy* 2021, 226, 120266. 624
47. Ampah, J.D.; Yusuf, A.A.; Afrane, S.; Jin, C.; Liu, H. Reviewing two decades of cleaner alternative marine fuels: Towards IMO's decarbonization of the maritime transport sector. *Journal of Cleaner Production* 2021, 320, 128871. 625
48. International Renewable Energy Agency. A pathway to decarbonise the shipping sector by 2050, 2021. www.irena.org (accessed November 03, 2021). 626

49. Vladimir, N.; Bakica, A.; Ančić, I. Predictions of noise levels on board ships by hybrid SEA: Application to Ro-Ro passenger ship and self-propelled cutter suction dredger. Proceedings of the 29th International Offshore and Polar Engineering Conference, Honolulu, Hawaii, USA, 2019. 4645-4651. 655
656
50. http://noise-control.com/Designer_Noise_Help/ (accessed April 08, 2021). 657
658

ARTICLE 8

Preprint of the published journal article.

Holistic energy efficiency and environmental friendliness model for short-sea vessels with alternative power systems considering realistic fuel pathways and workloads

Maja Perčić ^{1,*}, Nikola Vladimir ^{1,*}, Ailong Fan ², Ivana Jovanović ¹

¹ Faculty of Mechanical Engineering and Naval Architecture, University of Zagreb, Ivana Lučića 5, 10002 Zagreb, Croatia; maja.percic@fsb.hr (M.P.); nikola.vladimir@fsb.hr (N.V.); ivana.jovanovic@fsb.hr (I.J.)

² School of Transportation and Logistics Engineering, Wuhan University of Technology, China Affiliation; fanailong@whut.edu.cn (A.F.)

* Correspondence: nikola.vladimir@fsb.hr (N.V.)

Abstract: The energy requirements push the shipping industry towards more energy-efficient ships, while the environmental regulations influence development of environmentally friendly ships by replacing fossil fuels with alternative ones. Currently used mathematical models for ship energy efficiency, that set the analysis boundaries at the level of ship power system, are not able to consider alternative fuels as a powering option. In this paper, the energy efficiency and emissions index for ships with alternative power systems is formulated taking into account three different impacts on the environment (global warming, acidification, and eutrophication) and considering realistic fuel pathways and workloads. Besides diesel, applications of alternative powering options like electricity, methanol, liquefied natural gas, hydrogen and ammonia are considered. By extending the analysis boundaries from ship power system to the complete fuel cycle it is possible to compare different ships within the considered fleet or a whole shipping sector from a viewpoint of energy efficiency and environmental friendliness. The applicability of the model is illustrated on the Croatian ro-ro passenger fleet. Technical measure of implementation of alternative fuels in combination with an operational measure of speed reduction, results in even greater emissions reduction and increase in energy efficiency. Analysis of the impact of voluntary speed reduction for ships with different power systems resulted in the optimal combination of alternative fuel and speed reduction by a specific percentage from the ship design speed.

Citation: Lastname, F.; Lastname, F.; Lastname, F. Title. *J. Mar. Sci. Eng.* **2022**, *10*, x. <https://doi.org/10.3390/xxxxx>

Academic Editor: Firstname Last-name

Received: date
Accepted: date
Published: date

Publisher's Note: MDPI stays neutral with regard to jurisdictional claims in published maps and institutional affiliations.



Copyright: © 2022 by the authors. Submitted for possible open access publication under the terms and conditions of the Creative Commons Attribution (CC BY) license (<https://creativecommons.org/licenses/by/4.0/>).

Keywords: energy efficiency index; environmental friendliness; alternative fuels; fuel cycle; slow steaming; LCA

Nomenclature

Variables

<i>AP</i>	acidification potential (kg SO ₂ -eq)
<i>BS</i>	benefit for the society (mil. €)
<i>E</i>	emission (kg)
<i>EC</i>	energy consumption (kWh/nm)
<i>EEI</i>	energy efficiency and emission index (kg emission-eq/€)
<i>EP</i>	eutrophication potential (kg PO ₄ -eq)
<i>FC</i>	fuel consumption (kg/nm)
<i>GWP</i>	global warming potential (kg CO ₂ -eq)
<i>l</i>	trip length (nm)
<i>N_P</i>	annual number of passengers (-)

Abbreviations

A	Ammonia
CII	Carbon Intensity Indicator
D	Diesel
E	Electricity
ECA	Emission Control Area
EEDI	Energy Efficiency Design Index
EEXI	Energy Efficiency Existing Ship Index
EU	European Union
GHG	Greenhouse Gas
Gn-H	Green hydrogen

N_{RT}	annual number of round trips (-)	Gy-H	Grey hydrogen
N_V	annual number of vehicles (-)	H	Hydrogen
P	power (kW)	HFO	Heavy Fuel Oil
PR	price (€)	HPS	Hybrid Power System
SFC	specific fuel consumption (kg/kWh)	I4E	Energy Efficiency and Environmental Eligibility Index
t	trip duration (h)	IMO	International Maritime Organization
v	speed (kn)	IPS	Integrated Power System
<u>Subscripts</u>		LCA	Life-Cycle Assessment
AE	auxiliary engine	LNG	Liquefied Natural Gas
An	annual	M	Methanol
ave	average	MARPOL	International Convention for the prevention of Pollution from Ships
d	design	MDO	Marine Diesel Oil
ME	main engine	RES	Renewable Energy Source
P	passenger	SEEMP	Ship Energy Efficiency Management Plan
V	vehicles	UAE	United Arab Emirates
<u>Units</u>		USA	United States of America
kn	knot (nm/h)	<u>Greek letters</u>	
nm	nautical mile (1 nm = 1.852 km)	α	weighting factor for <i>GWP</i>
		β	weighting factor for <i>AP</i>
		γ	weighting factor for <i>EP</i>

31

1. Introduction

32

1.1. Regulatory framework for energy efficiency and the environmental footprint in the shipping sector

33

34

Since the Kyoto Protocol in 1997, Greenhouse Gases (GHGs) are recognized as the ones that negatively affect the Earth climate, causing the global warming, and therefore their concentration in the atmosphere needs to be reduced [1]. Their main anthropogenic source is fossil fuel combustion, and the major reduction needs to tackle the energy and transport sector [2].

35

36

37

38

39

In the shipping sector, fossil fuels, such as Heavy Fuel Oil (HFO) and Marine Diesel Oil (MDO), are still mainly used for powering the ships, although they have high carbon content and their combustion produces a great amounts of carbon dioxide (CO₂), which is the main GHG, together with pernicious emissions of nitrogen oxides (NO_x) and sulphur oxides (SO_x) [3]. In order to deal with the increased emissions due to extensive use of fossil marine fuel, International Maritime Organization (IMO) set several standards for their control within the International Convention for the prevention of Pollution from Ships (MARPOL) [4]. By establishing Emission Control Areas (ECAs), IMO put control over SO_x and NO_x emissions released by ships in specific areas, where emission requirements are stricter than outside them [5]. SO_x is controlled based on the allowed sulphur content in fuel, while the NO_x limit depends on the engine's maximum operating speed. The NO_x regulation standards Tier I and Tier II refer to the global area of navigation, while Tier III is specified for the NO_x ECAs [6].

40

41

42

43

44

45

46

47

48

49

50

51

52

One of the most important attempts to reduce CO₂ emissions generated by the shipping sector was the introduction of energy efficiency regulation in 2011 by IMO, according to which every ship of GT = 400 and above engaged in international shipping need to have the International Energy Efficiency (IEE) Certificate. In order to obtain it, the ship has to comply with the Energy Efficiency Design Index (EEDI) requirements and have the Ship Energy Efficiency Management Plan (SEEMP). SEEMP is an operational measure for

53

54

55

56

57

58

improvement of ship energy efficiency applicable to all ships above GT = 400, while EEDI represents a technical measure of energy efficiency expressed as a ratio of mass flow of CO₂ per transport work, and it should be calculated for each new ship which should be lower or equal to required EEDI [7]. In close to its present form, EEDI was first shown as a CO₂ emissions index, also representing a ratio of CO₂ emission and transport work (g CO₂ / ton mile), but it was calculated in a more simplified manner [8].

In order to expand the energy efficiency requirements on existing ships, in 2021, IMO extended ship energy efficiency regulative with new regulations on Energy Efficiency Existing Ship Index (EEXI) and Carbon Intensity Indicator (CII), which will enter into force from 1st of January 2023. Such as its predecessor EEDI, EEXI should be applied for all ships above 400 GT falling under MARPOL Annex VI, but unlike EEDI, EEXI applies to existing ships outside EEDI regulations [9], [10]. While EEXI refers to the technical measure of energy efficiency, CII represents the operational measure of energy efficiency and needs to be embedded into SEEMP. CII measures CO₂ emissions per transport work, and it applies on ro-ro passenger, cargo and cruise ships over 5,000 GT [11].

Ship's EEDI is based on sea trials at delivery, adjusted to calm water conditions, which is an unrealistic state and it is rather an exception. Lindstad et al. [12] indicated that without adjusting tests to include also real-sea conditions (influence of wind and waves), GHGs reduction would not be as much as desired. Since shipping results in pernicious emissions that impact the environment through different processes, Ančić et al. [13] introduced the Energy Efficiency and Environmental Eligibility Index (I4E) that combines different environmental impacts of CO₂, NO_x and SO_x emissions. The authors analyzed the fleet of ro-ro passenger ships, however, they did not consider alternative powering options but only diesel as a marine fuel. Ančić et al. [14] presented a new methodology based on a holistic approach to analyze the energy efficiency of ships with Integrated Power Systems (IPS) based on their technical and hydrodynamic properties. They analyzed the energy efficiency of the ro-ro passenger fleet consisting of 384 ships, out of which 48 of them have IPS or Hybrid Power Systems (HPS), and the results indicated that ships with HPS and IPS are more energy-efficient than a fleet average. In both studies, the authors attempt to modify current energy efficiency requirements for ro-ro passenger ships, which are predominately powered by diesel engines. The accuracy of EEDI to represent the environmental impact of future ship power systems is investigated in a study by Trivyza et al. [15], on the example of a tanker and cruise ship. They performed a comparison of EEDI and lifetime CO₂ emissions for different ship power system solutions with included after-treatment systems (exhaust gas scrubber, selective catalytic reduction system, and carbon capture system), and energy efficiency technologies (waste heat recovery system and shaft generator). The results indicated that EEDI and lifetime CO₂ emissions point out different options as optimal, and even for solutions that include greener technologies, EEDI did not manage to describe the real environmental impact of both tanker and cruise ship power systems. However, the study did not investigate any other alternative fuel except natural gas, and the lifetime CO₂ refers to the CO₂ emissions released from the ship operation during the lifetime exploitation period.

By following up the IMO's decarbonization strategy, according to which ships engaged in international shipping should reduce their annual GHGs emissions by 50% up to 2050, and carbon intensity by 40% decrease by 2030 and 70% by 2050, all compared to 2008 levels [16], the approach of analyzing the energy efficiency of a ship should be improved with some decarbonization measures. Hüffmeier and Johanson [17] presented state-of-the-art methods for the improvement of ship energy efficiency. They indicated that the way towards greener shipping requires the implementation of technical and operational measures onboard vessels, together with policy changes in order to reduce fossil fuel consumption on the entire shipping industry level.

The required increase in energy efficiency and reduction of the environmental impact of ships can be achieved by the implementation of decarbonization measures. Most of them ultimately lead to the reduction of fossil fuel consumption, through the improvement of ship design, reduction of ship resistance, application of energy-efficient power system, speed reduction, or imposition of a charge for ships that use fossil fuel [18], [19].

Technical measures relate to the phase of ship design. Hull design, optimization of propeller/trim/speed and minimizing losses lead to a reduction of required power and consequently fossil fuel consumption and emissions. Minimal losses can be achieved either by improvement of particular equipment or by rearranging the ship power system in a IPS or HPS [20]. The implementation of Renewable Energy Sources (RESs) onboard ships also leads to the reduction of their environmental footprint. RESs are not used as standalone, and they are usually integrated within HPS [21] or electric ship power systems, such as the implementation of photovoltaic cells in a battery-powered ship [22]. The greatest technical measure for the reduction of the environmental impact of ships is the ultimate replacement of conventional power systems with alternative power by alternative cleaner and greener fuel, preferably with zero carbon content [23]. The advantages and disadvantages of certain marine fuels are summed in Vladimir et al. [24]. Currently, the most used alternative marine fuels are fossil Liquefied Natural Gas (LNG) and methanol. These two fuels are fossil fuels with lower carbon content than diesel fuel [25], [26]. One of the alternative solutions that offers zero-emission shipping, i.e. ship operation without tailpipe emissions, is full electrification with only energy storage, such as a battery [27]. It should be pointed out that shipping can be considered as zero-emission only if the analysis boundary is set at the level of ship power system or ship itself, but not to the overall power generation process. In spite of greatly reduced environmental impact and well-known technology, the battery-powered ship is investigated for the short-sea shipping sector and not for ocean-going vessels [28], since the main limitations of the battery-powered ship are investment costs and range on which the ship can operate, which depend on battery capacity and its energy density [29]. Along with electricity, hydrogen and ammonia are also considered as zero-carbon fuels applicable for maritime purposes, which can be used in the internal combustion engine, but rather in fuel cells due to the fast kinetics and higher efficiency [30]. Since the absence of tailpipe emissions, the environmental footprints of such zero-emission solutions are usually investigated with the Life-Cycle Assessment (LCA) [31].

Technical measures refer to the design of the ship, while operational measures tend to reduce emissions during the ship's operation, and they do not require great investment costs. Weather routing, voyage optimization, fleet management, optimized maintenance and slow steaming are some of the operational speeds that are usually used for the reduction of fossil fuel consumption [19]. Slow steaming refers to the voluntary speed reduction way below design speed, and it is a great operational measure for emission reduction [32]. Since fuel consumption and main engine power depend on ship speed, with its reduction, fossil fuel consumption is also reduced. When observing total ship power, including the main and the auxiliary engines, by greatly reducing the speed, required energy increases, as indicated in a study by Ritari et al. [33].

Each measure contributes to the emission reduction at a certain level, but the combination of technical and operational measures would result in even greater emission reduction, not only GHGs, but also SO_x and NO_x emissions.

1.3. Research gap and the aim of the paper

Conventional power systems are still dominant in shipping sector. However, stringent environmental regulations and strategies are forcing the shipping sector towards the implementation of energy-efficient and greener solutions. The application of cleaner fuels with lower carbon content than currently used marine fuel has the great potential to achieve the emission reduction. This is recognized by shipbuilders and ship-owners, and

recently the percentage of ships powered by alternative power systems has been significantly increased among new orders, Figure 1, [34]. Therefore, formulation of relevant index to assess energy efficiency and environmental friendliness of such vessels becomes ever more important, since this trend can be expected in the future.

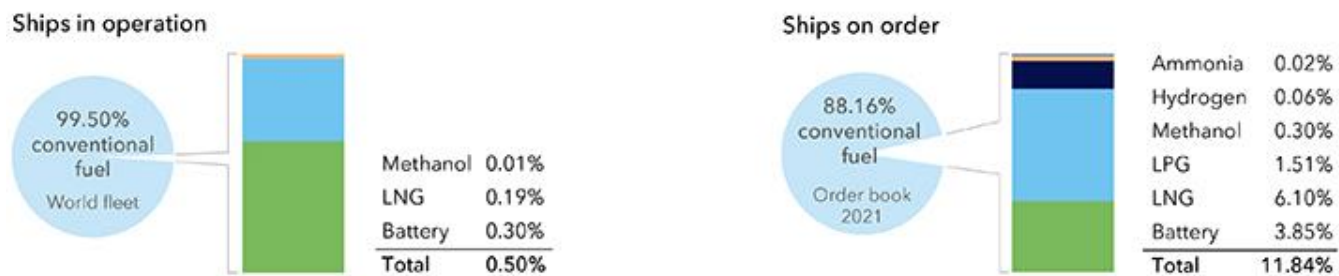

Figure 1. Alternative fuels uptake in 2021 (reproduced from [34] with permission of DNV, 2022)

In this paper, the formulation of energy efficiency index applicable for ships with alternative powering options is presented. Besides diesel that serves as a baseline scenario, five alternative fuels are investigated, i.e. electricity, methanol, LNG, hydrogen and ammonia. The analysis of the emissions released by different power systems is done by the LCA, considering three impact categories, i.e. global warming, acidification and eutrophication. Also, the economic analysis including revenues and expenditures related to ship operation is done. The applicability of the model is illustrated on the Croatian ro-ro passenger fleet.

This paper proposes mathematical model for simultaneous assessment of ship energy efficiency and environmental friendliness, which can be applied not only to diesel engine powered ships, but to a range of alternative powering options. It is evident that at the level of ship power system some vessels, e.g. an electric ship, can be absolutely neutral for the environment, but only a complete energy production pathway can offer an insight into their exact environmental impact. For this purpose, calculation of I4E index presented by Ančić et al. [13] is extended to the complete fuel pathway in the LCA environment. Energy efficiency and environmental friendliness determined in this way do not represent the feature of the ship itself, but clearly indicates whether some technical solutions and the way the ship power system is exploited, are beneficial for the environment or not. It should be clear that the presented model that simultaneously considers ship energy efficiency and environmental friendliness should not be applied to compare ships from different shipping sectors (even if they are within the same type). Namely, this formulation takes into account fuel pathways and energy mix, which are specific to a certain location.

The analysis of speed reduction on calculated emissions and economic profit related to certain ships leads to the optimal solution that combines technical (alternative fuel) and operational (speed reduction) measures, which greatly reduce environmental footprint and increase the profit.

The main contributions of this paper can be summarized as follows:

- Development of the energy efficiency index applicable for ships with alternative power systems, which takes into account different impact categories of ship environmental footprint considering life-cycle emissions.
- Identification of a combination of optimal technical and operational measures that result in lower costs, emission and ultimately lower energy efficiency index compared to currently used diesel power system configuration.

2. Methodology

2.1. Formulation of energy efficiency index for ships with alternative powering options

The purpose of energy efficiency indexes is to provide a fair comparison of ships, stimulate their development toward implementation of greener and energy-efficient technologies, and establish minimum energy efficiency for ships that undergo specific energy efficiency index requirements [14]. According to EEDI and EEXI, the energy efficiency of a ship is expressed as a ratio between the CO₂ mass flow produced by the ship power system, i.e. CO₂ tailpipe emissions, (numerator) and the transport work, i.e. benefit for the society (denominator) [9]. For ships with alternative power systems, these indexes are not applicable, especially since some alternative fuels, such as hydrogen, electricity, ammonia etc., result in the absence of tailpipe emissions, leading its value to zero.

Besides GHGs, which refer to emissions of CO₂, methane (CH₄) and nitrous oxide (N₂O), the combustion of marine fossil fuel also results in the release of pernicious emissions such as NO_x and SO_x. GHGs contribute to global warming, while SO_x and NO_x emissions negatively affect human health and terrestrial and aquatic ecosystems through the processes of acidification and eutrophication [35]. In order to investigate a ship's impact on the environment through different impact categories and to evaluate its energy efficiency, I4E index presented in [13] is modified into energy efficiency and emission index (*EEl*) which is applicable for ships powered by alternative power systems:

$$EEI = \frac{\alpha \cdot GWP + \beta \cdot AP + \gamma \cdot EP}{BS}, \quad (1)$$

where an evaluation of different emission contributions is performed by involving the Global Warming Potential (*GWP*), Acidification Potential (*AP*) and Eutrophication Potential (*EP*), while *BS* refers to the benefit for the society. The determination of the weighting factors (α , β and γ) is complicated and it depends on the area of application. In this paper, the weighting factors ($\alpha = 0.095$; $\beta = 18.3$; $\gamma = 21.1$) are obtained from the study by Ančić et al. [13], which also considers the ro-ro passenger ships that spend much more time in ports and near populated areas than other ships. In that manner, the NO_x and SO_x directly impair the air quality for the local population, while the GHGs, in this case, are not so pernicious and it contributes to air pollution on a global scale, while NO_x and SO_x are primarily local pollutants. As can be seen from a number of references, normalization of emissions and selection of weighting factors can be done in different ways depending on the assumed impact of the considered item. Therefore, a sensitivity study of the used weighting factors is included in the discussion.

GWP represents a measure of how much energy the emission of one ton of a gas will absorb over a given period relative to the emission of 1 ton of CO₂. It is calculated by multiplying CO₂-equivalent (CO₂-eq) factors over 100 years (CO₂: 1; CH₄: 36; N₂O: 298) [36]:

$$GWP = (1 \cdot E_{CO_2} + 36 \cdot E_{CH_4} + 298 \cdot E_{N_2O}). \quad (2)$$

AP is calculated by multiplying the emissions of a particular acidifying gas by the SO₂-equivalence factors (SO₂-eq) (SO_x: 1; NO_x: 0.7), as in the following equation [37]:

$$AP = 1 \cdot E_{SO_x} + 0.7 \cdot E_{NO_x}. \quad (3)$$

EP is calculated by multiplying the NO_x emission with PO₄-equivalence factor (PO₄-eq) (NO_x: 0.13) according to the following equation [37]:

$$EP = 0.13 \cdot E_{NO_x}. \quad (4)$$

In order to compare different power systems, whether resulting in tailpipe emissions or not, the annual life-cycle emissions are considered, while the *BS* refers to the annual

profit of a particular ship. The calculation of *EEI* for different power systems are performed according to the procedure presented in Figure 2.

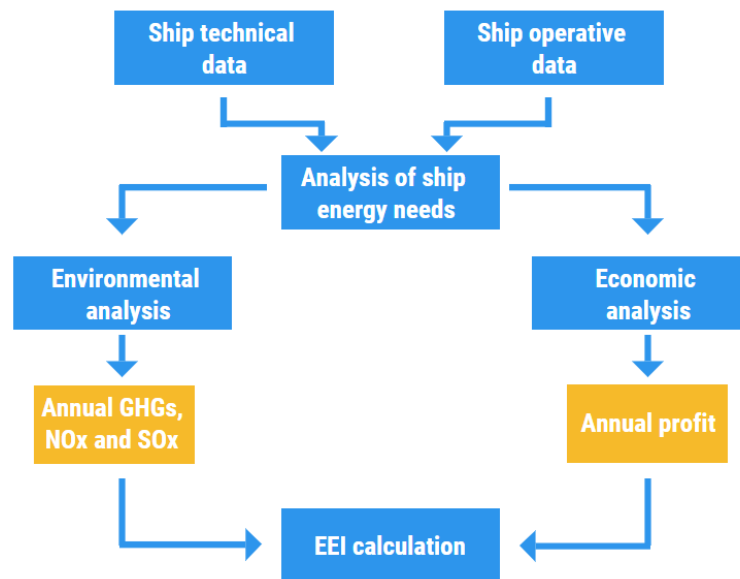

Figure 2. The methodology flowchart.

In the first step of the methodology, certain ship data regarding ship design and operation are required to assess the ship energy needs. The obtained results represent inputs for environmental and economic analyses, whose results are annual emissions and annual profit, which are used to calculate different environmental impact potentials (*GWP*, *AP*, and *EP*), and finally lead to the calculation of *EEI*.

2.2. The Croatian ro-ro passenger fleet

The ro-ro passenger ships, i.e. ferries, are ships that transport passengers and vehicles on short distances. The considered Croatian ro-ro passenger fleet consists of diesel-powered ships that operate in the Adriatic Sea on 23 domestic lines and 3 international lines connecting Croatia and Italy [20], Figure 3. In this paper, only domestic ferry lines are taken into account.

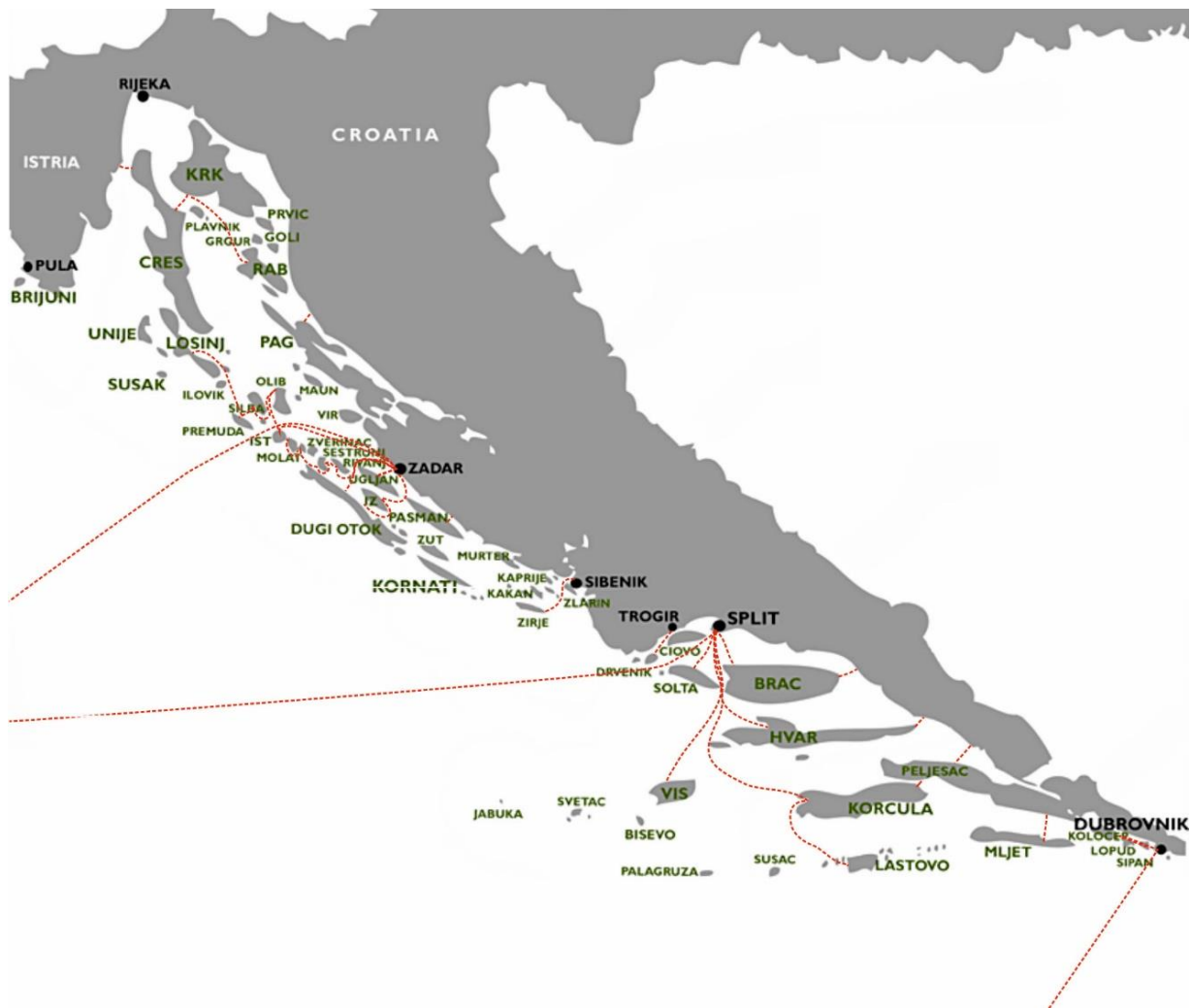

Figure 3. Croatian ferry lines

These ships connect Croatian islands and the mainland, thus spending much time near populated areas and directly impairing the air quality of the surrounding area. Therefore, the emission reduction of such ships is very significant [38], [39].

The particulars of ships that operate on 22 ferry lines are presented in Table 1, while one ferry line is omitted from the analysis since, during the two-stop route, the ship is altered with another ship. The data on design speed, v_d (kn), main engine power, P_{ME} (kW) and auxiliary engine power, P_{AE} (kW), required for average speed and energy needs calculation, were obtained from the Croatian Register of Shipping [40]. Duration of a trip, t (h) and its length, l (nm), annual number of round trips (N_{RT}), for each ship together with average prices of a ticket for a vehicle, PR_V (€), and a passenger, PR_P (€), were taken from [41], while the data of the annual number of transported passengers, N_P , and vehicles, N_V , on particular lines are obtained from [42].

In order to calculate fleet's energy needs by following the cubic relation between ship power and its speed [43], the average operating speed, v_{ave} (kn), needs to be obtained since it usually differs from the ship design speed, due to voluntary speed reduction (slow steaming), maintaining the shipping schedule, etc. Therefore, by dividing the route length with its duration, v_{ave} is calculated, while the average main engine power, $P_{ME,ave}$ (kW) is calculated then with the following equation:

$$P_{ME,ave} = (P_{ME} \cdot 0.8) \cdot \left(\frac{v_{ave}}{v_d}\right)^3 \tag{5}$$

Table 1. T Particulars of selected ships [40], [41], [42]

Ship route	P_{ME} (kW)	P_{AE} (kW)	v_d (kn)	t (h)	l (nm)	N_{RT}	N_P	N_V	PR_P (€)	PR_V (€)
Biograd-Tkon	806	824	7.5	0.33	1.35	3,900	417,713	123,104	1.6	13.33
Prizna-Žigljen	792	84	8	0.25	1.61	1,590	777,360	320,409	1.87	17.87
Orebić-Dominče	1,790	444	12	0.33	1.83	5,520	602,838	253,184	1.73	13.87
Brestova-Porozina	1,616	444	11	0.33	2.81	3,540	467,932	198,565	2	23.73
Sučuraj-Drvenik	806	824	7.5	0.58	3.40	2760	337,608	126,888	1.73	20.67
Zadar-Preko	1,968	532	13	0.42	3.45	5700	1,159,218	417,384	2	17.73
Valbiska-Merag	1,968	272	12	0.42	3.62	3960	974,081	431,391	2	23.73
Sobra-Prapratno	2,352	480	12	0.33	5.72	1560	137,499	55,189	3.07	29.73
Sumartin-Makarska	882	102	10	0.83	6.96	1260	118,589	32,118	3.2	30.67
Suđurađ-Dubrovnik	1,986	1,921	12.5	0.42	8.10	480	17,744	4,636	2.53	30.67
Ploče-Trpanj	1,764	840	12.3	1	8.14	1740	390,170	164,022	3.6	25.07
Split-Supetar	1,968	630	13	0.83	8.85	3720	1,667,571	423,232	3.73	30.67
Split-Rogač	1,788	645	12	1	8.90	1620	347,536	93,122	3.73	30.67
Drvenik Veli- Trogir	794	102	11.5	1.17	9.66	600	109,161	5,674	1.73	30.67
Šibenik-Žirje	882	72	11	1.33	11.60	540	43,090	7,270	2.53	35.33
Valbiska-Lopar	1,764	1,080	12.3	1.33	15.29	960	125,715	47,221	4.13	24
Zadar-Brbinj	1,764	840	12.3	1.67	15.76	870	189,905	78,205	3.33	35.33
Zadar- M. Rava	1,648	270	14	2	19.16	152	39,061	14,532	3.07	17.73
Split-Stari Grad	1,968	630	13.2	2	22.88	1740	612,601	180,621	5.2	61.33
Zadar-Ist	1,140	200	11	2.67	27.42	240	19,667	7,566	2.67	35.33
Split-Vis	3,600	1,944	15.75	2.33	30.18	800	244,589	64,879	6	62.67
Zadar-M.Lošinj	2,646	348	16	5.25	63.68	240	28,828	9,373	3.47	30.67

The average load of the auxiliary engine(s) is estimated to be 50%. By summing up $P_{ME,ave}$ and $P_{AE,ave}$, the total average ship power is calculated. The energy consumption per distance, EC (kWh/nm), can be calculated as follows:

$$EC = \frac{P_{ave}}{v_{ave}}, \tag{6}$$

while the annual energy consumption, EC_{An} (kWh) is calculated according to:

$$EC_{An} = N_{RT} \cdot 2 \cdot l \cdot EC. \tag{7}$$

The general expression for the calculation of fuel consumption per distance, FC (kg/nm) is:

$$FC = EC \cdot SFC, \tag{8}$$

where SFC (kg/kWh) refers to the specific fuel consumption. The annual fuel consumption is calculated in the same way as EC_{An} with equation (8).

Data on energy consumption are required for the environmental assessment as an input for the LCA, while the data on both fuel consumption and energy consumption are necessary for cost analysis.

298
299
300

301
302
303
304
305
306

307
308
309

310
311
312

313
314
315

316
317
318
319
320

2.3. Environmental analysis

The LCA represents a method for assessing the environmental impact of a product, process or system by taking into account emissions released through their stages of a life cycle [44], Figure 4.

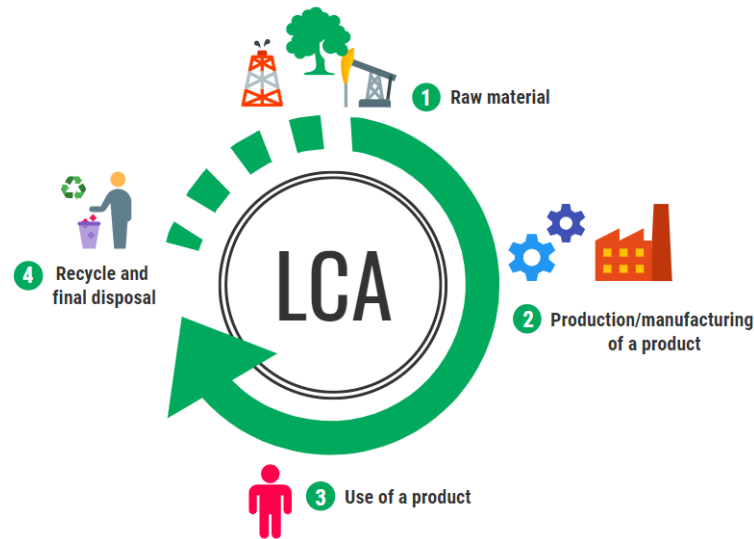

Figure 4. Life-cycle stages of a product.

In this paper, the life-cycle emissions of different power systems are obtained by performing LCA by means of GREET 2020 software [45]. The annual GHG, SO_x and NO_x emissions are related to a fuel cycle, which includes processes from raw material extraction and its transportation to the production facility, production of fuel and its distribution to the refueling station, and use of the fuel in a ship power system that results in tailpipe emissions. The specific processes included in the LCAs and the mathematical models of implementation of alternative fuels in ship power systems are obtained from [46] and [47].

2.4. Economic analysis

The performed economic analysis investigated lifetime revenues and expenditure related to ship operation in order to calculate benefit for the society, *BS* (€), of observed ro-ro passenger fleet. *BS* represents the economic profit of a particular line calculated with the following equation:

$$BS = Revenue - Expenditure, \tag{9}$$

where the revenue and expenditure are calculated on basis on annual basis. Revenue refers to the income of the sold tickets, and it is calculated by multiplying the average prices of a tickets and an annual transported passengers and vehicles from Table 1:

$$Revenue = N_p \cdot PR_p + N_v \cdot PR_v. \tag{10}$$

Expenditure refers to the sum of investment, maintenance, equipment replacement and fuel costs. The costs related to the ship power system fueled with hydrogen and ammonia are gathered from a study by Perčić et al. [30], while costs related to the ship power system fueled with other considered fuels are obtained from [46].

3. Results and discussion

In order to calculate the *EEI* that gathers different impacts on the environment, and it is applicable for ships with alternative fuels, the environmental and economic analyses of the Croatian ro-ro passenger fleet have been done. In the following results, D denotes diesel, E is electricity, M stands for methanol, H refers to hydrogen, and A denotes ammonia.

Firstly, the environmental analysis is performed where annual GHGs, NO_x and SO_x emissions are calculated. The fuels with the highest amount of GHG emissions expressed are ammonia and hydrogen. Although they are zero-carbon fuels, it is considered that they are produced from natural gas, i.e. fossil fuel, and their production processes lead to great atmosphere pollution with GHG emissions. The alternative solution that provides the lowest contribution to global warming is the full electrification with Lithium-ion (Li-ion) battery, with around 50% lower GHGs than the diesel-powered ship, followed by methanol and LNG used in dual-fuel engines. Regarding NO_x emissions, the diesel-powered ship has the highest amount due to its tailpipe emissions, for 98% higher than the battery-powered ship, which has the lowest life-cycle NO_x emissions among considered fuels. However, when observing life-cycle SO_x emissions, electrification does not represent a great alternative option since electricity generation resulted in a great amount of SO_x emissions, just a slightly lower than diesel power system configuration, which is mainly due to the electricity mix used for its production.

The results of the economic analysis highlighted electrification as the most cost-effective option among those considered. However, the analysis also revealed that two ships operating on ferry lines (Zadar - M. Lošinj and Suđurađ - Dubrovnik) are not profitable even when they are powered by diesel fuel. Therefore, those two ships are omitted from further analysis and calculation of *EEI*.

Economic analysis indicated that LNG power system configuration onboard ships with small annual mileage results in the highest costs, mainly due to the high investment and fuel cost. However, although hydrogen price is high (3.3 €/kg), its use in a fuel cell onboard ships with lower annual mileage resulted in lower overall costs than LNG, mainly due to the lower investment costs of low-temperature Proton Exchange Membrane Fuel Cell, which is the cheapest fuel cell compared to other types of the fuel cell. Moreover, short route length and a moderate number of round trips per year result in absence of equipment replacement costs during the ships' exploitation period since the lifetime of the main equipment of that power system depends on the ship's operating hours. However, the hydrogen power system configuration implemented on ships with moderate or high annual mileage represents the powering options with the highest costs due to the long routes and long operating hours during the ship's lifetime.

Based on the data from environmental and economic analyses, *EEIs*, expressed in kg emission-eq per €, for the 20 ro-ro passenger ships powered by different power systems are calculated, Figure 5. The ships are lined up from the shortest to the longest route.

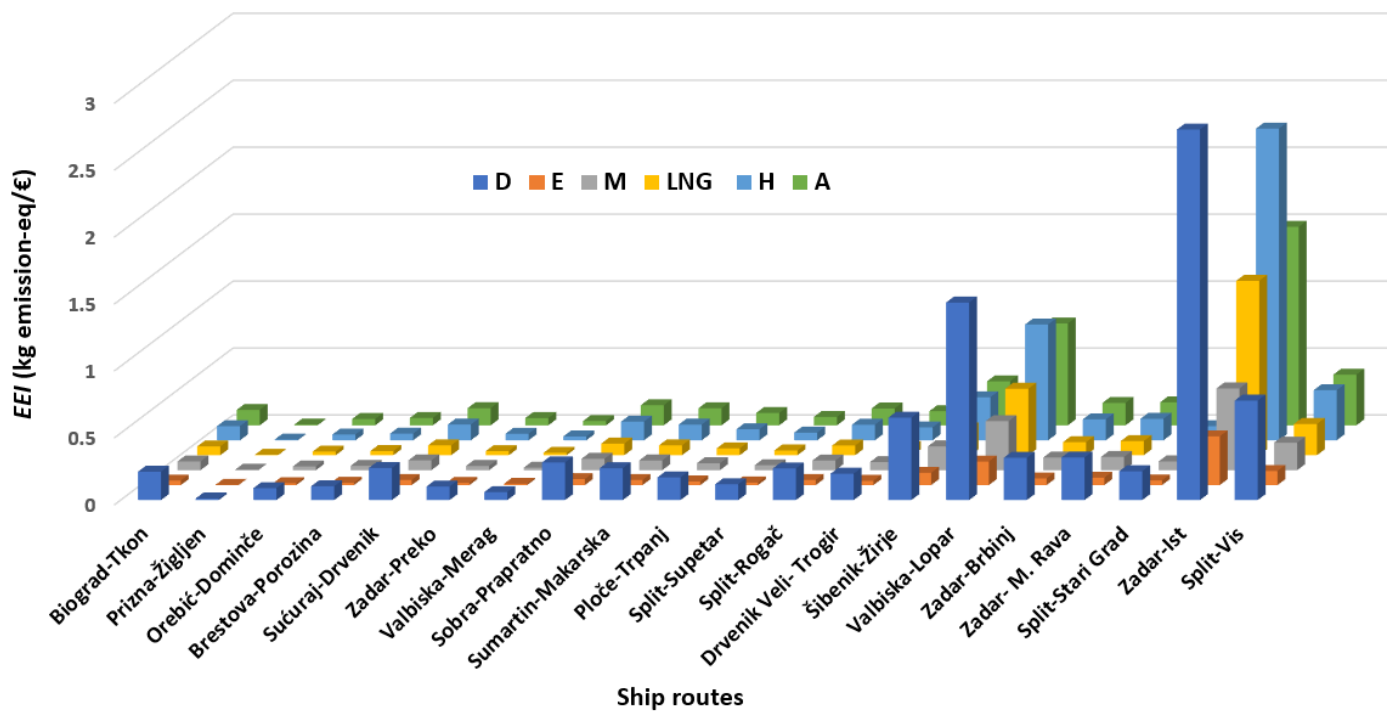

Figure 5. Calculated *EEI* for ships with different power systems.

It is considered that the ship with an alternative power system is energy efficient and environmentally friendly if its *EEI* is lower than the *EEI* of a diesel-powered ship, which is currently used in selected ships, and it is the most represented power system in the shipping sector. According to the results presented in Figure 5, each considered alternative powering option is a better power solution than the diesel-powered ship, while the full electrification with only a battery represents the most energy-efficient and environmentally friendly option among those considered.

The results presented in Figure 5 also pointed out two ships that operate on ferry lines Valbiska-Lopar and Zadar-Ist, resulting in very high *EEIs* compared to the rest of the considered fleet. Those two hydrogen-powered ships have a greater *EEI* than the ammonia-powered ship, which is not the case for the rest of the fleet. The main reason for that is high emissions and very low profits. Since the low revenue, the difference between the costs of ammonia and hydrogen comes to light. Hence, the hydrogen results in higher costs and its use greatly affects the profit on this line, while the use of ammonia results in a higher profit of 43% compared to the profit of the hydrogen-powered ship.

In this paper, the *EEIs* are calculated for existing ships that navigate at the average operative speed, which is more appropriate than the calculation of *EEIs* with a design speed since most of the ships operate in different regimes. Operative ship speed is often voluntarily reduced way below its design speed (slow steaming) to achieve fuel savings, which leads to emission reduction. The analysis of the impact of speed reduction on annual CO₂-eq emissions and *BS* is performed, where the results are illustrated on the three selected ro-ro passenger ships. These ships are of different sizes, and they operate on different routes. Ship 1 operates on one of the shortest Croatian ferry lines, Ship 2 transports passengers and vehicles on a medium-range route, while Ship 3 operates on one of longest ferry line in Croatia. More details on these ships can be found in previous works of the authors [30], [46].

Firstly, the annual CO₂-eq emissions and annual profit are calculated for operating speed that is equal to the design speed (v_d). Secondly, the operating speed is reduced by a step of 20% concerning the v_d , and the corresponding emissions and profits are calculated for each speed. In the following results, $0.8v_d$ denotes reduction of 20%, $0.6v_d$ refers to the reduction of 40%, $0.4v_d$ represents the speed reduction for 60%, and ultimately $0.2v_d$

398
399
400
401
402
403
404
405
406
407
408
409
410
411
412
413
414
415
416
417
418
419
420
421
422
423
424
425
426
427
428
429
430
431

denotes reduction per 80% from the initial design speed. The results are presented in Figure 6 and Figure 7.

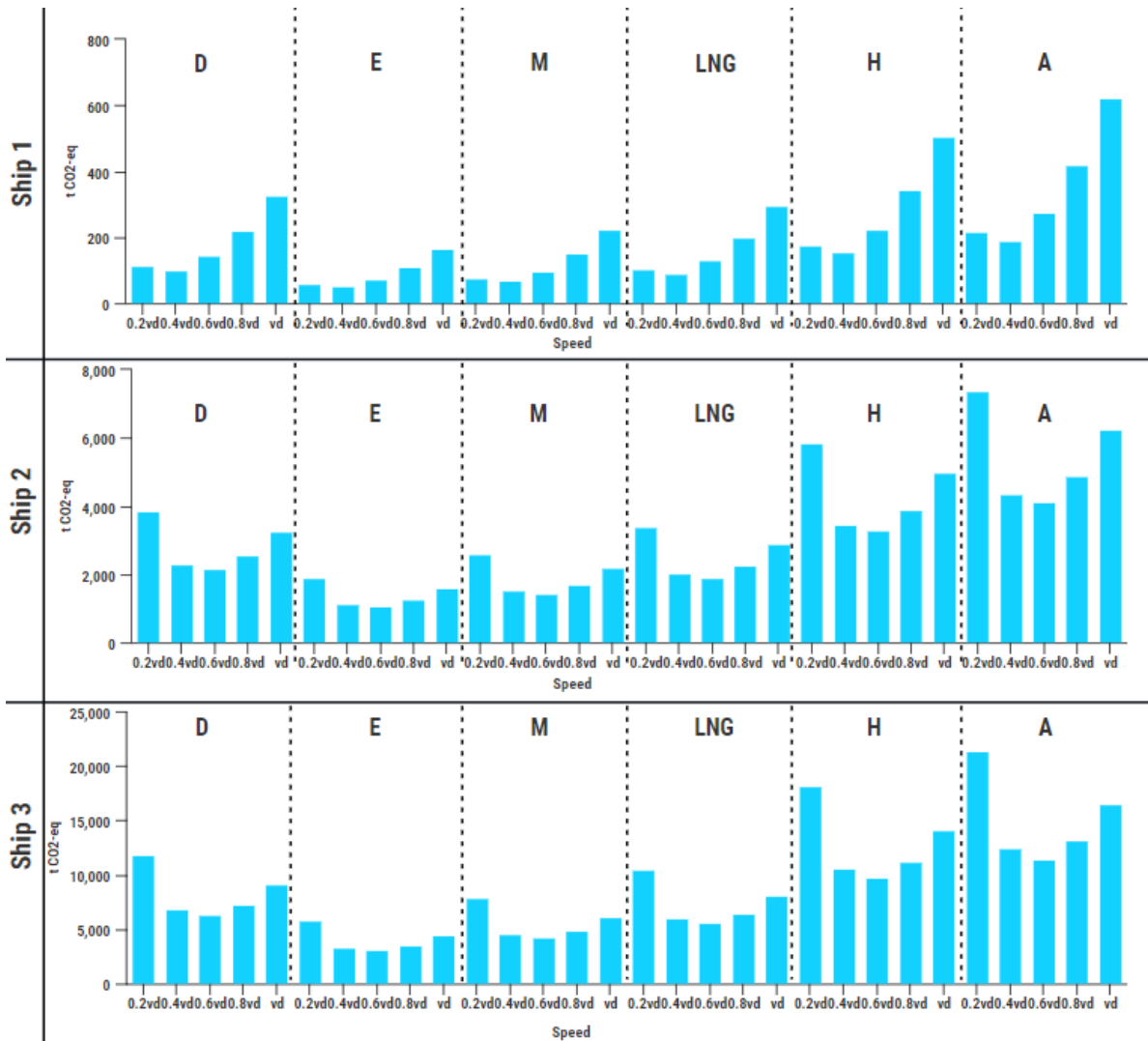

Figure 6. Impact of speed reduction on annual CO₂-eq emissions of ships with different power systems.

According to the results presented in Figure 6 and Figure 7, it can be concluded that with the speed reduction of 60% for Ship 1, and speed reduction of 40% for Ship 2 and Ship 3, the emissions and costs reach their minimum, while with the further reduction of speed, their values increase. The reason for that is taking into account the total power of the ship, i.e. main engines power and auxiliary engines power. If the paper only considered main engine power, with the speed reduction, the emission and costs would be reduced, and the power-speed function would not have its minimum.

Speed reduction greatly affects the economic profit of fully electric ships due to its impact on each considered cost, while for ships powered by ammonia and hydrogen, the speed reduction only influences fuel costs since other costs are related to the installed fuel cell power, and they are not dependent on operative features of the ship. Since the installed auxiliary engines power for both Ship 2 and Ship 3 is greater than for Ship 1, by lowering the speed to 80% of design speed, emissions and costs related to Ship 2 and Ship 3 increase way higher than the levels when the ship is operating at design speed. Optimal operational measure for Ship 1 is the speed reduction by 60%, while the results presented in Figure 6 and Figure 7 indicated that the optimal emission reduction combination of measures for Ship 2 and Ship 3 is the full electrification with speed reduction by 40%.

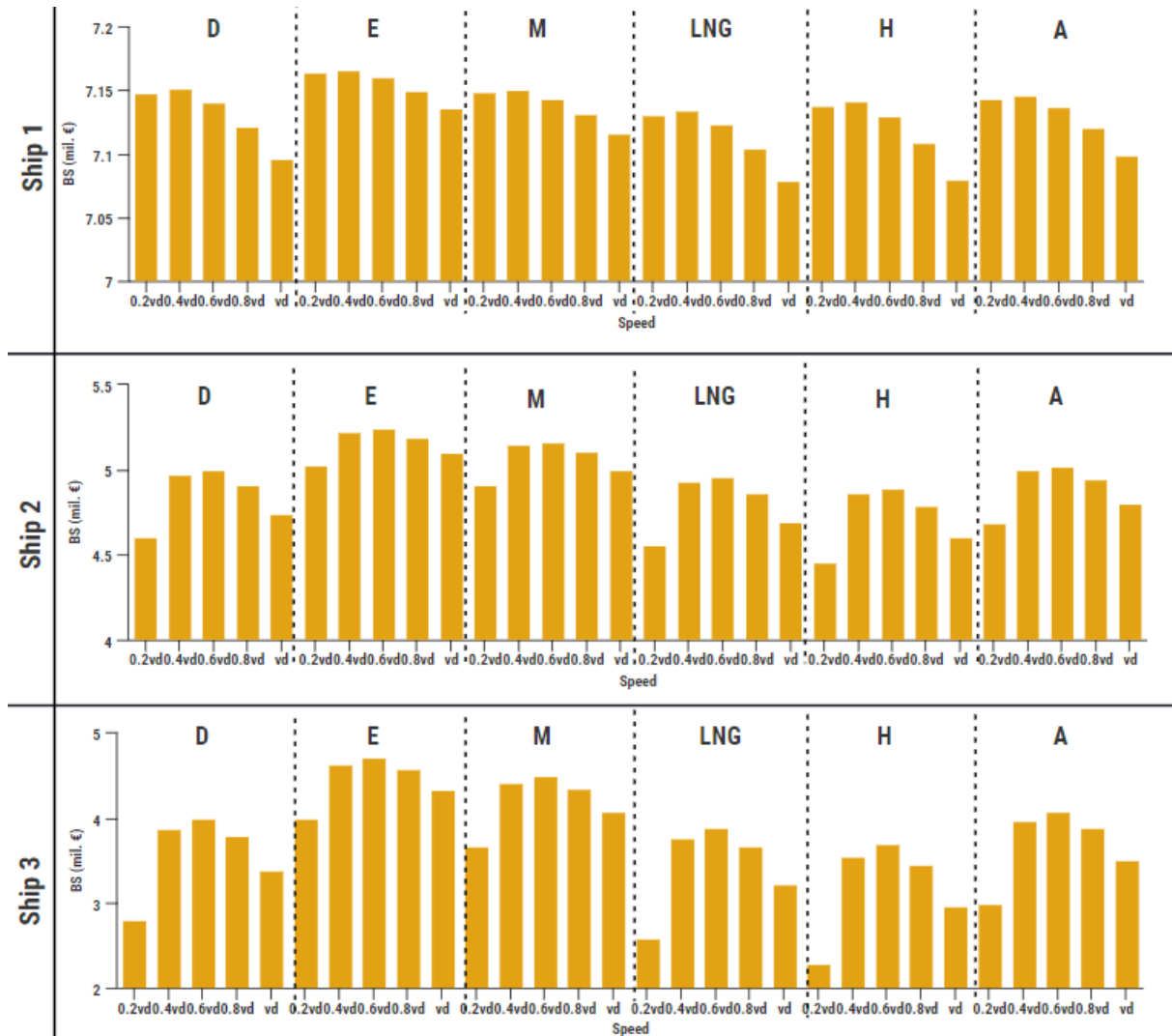

Figure 7. Impact of speed reduction on annual economic profit of ships with different power systems.

After identifying the optimal combination for selected ships, their *EEIs* are calculated and presented in Figure 8 together with *EEIs* for diesel and electricity when they operate at average speed and design speed.

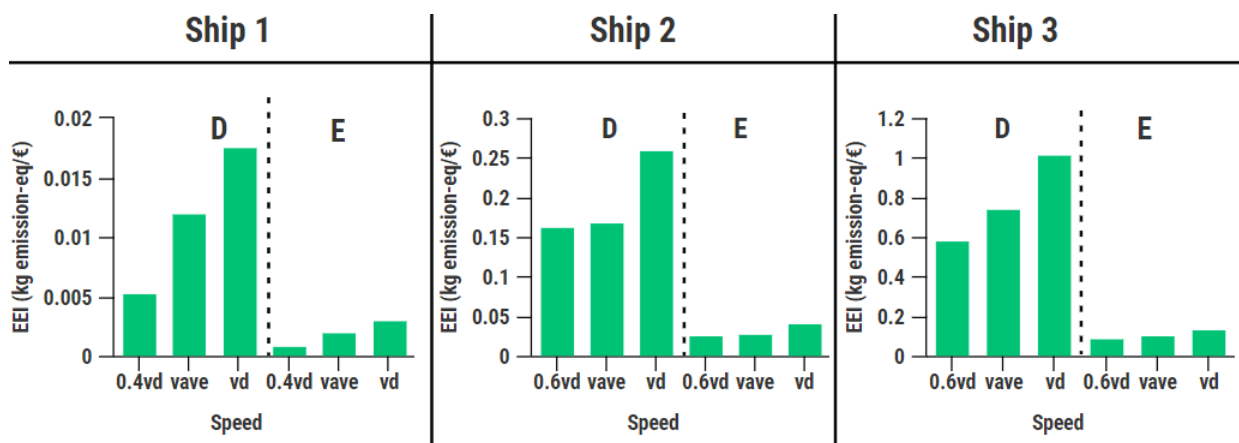

Figure 8. *EEIs* comparison of diesel-powered ships and electricity-powered ships operating at different speeds.

The results of *EEIs* comparison in Figure 8 indicate a greater reduction of *EEI* for electric Ship 1 than for electric Ship 2 and electric Ship 3, compared to their diesel power system configuration. Since the existing diesel-powered Ship 2 is already operating at a lower speed than its design speed, a speed reduction of 40% from the design speed would result in prolongation of the duration of the trip by 6 minutes, while reducing GHGs and costs would be 50% and 48%. Total *EEI* reduction, in that case, is 84%. However, when the combination of electrification and speed reduction of 40% is applied on Ship 3, *EEI* is reduced by 88% compared to the diesel-powered ship operating at average speed. Although it results in GHGs and costs reduction by 58% and 54%, the duration of the already very long ferry route is prolonged for 52 minutes. The full electrification and reduction of speed by 60% ($0.4v_d$) from design speed represent the optimal combination of measures for Ship 1. The duration of the route would be prolonged for 15 minutes, and the total trip would last for 30 minutes, which seems to be acceptable, bearing in mind that this combination would lead to a reduction of 55% in CO₂-eq emissions, a reduction of 77% in total costs and a reduction of 92% in *EEI*, compared to the ship's emissions and profits when is operating at average speed powered by diesel engines.

The use of alternative fuels is location-specific, i.e. it depends on the energy mix used for fuel production, and on specific pathways and distribution chains of fuels. The sensitivity of *EEI* with respect to energy mix modifications is illustrated on Ship 2.

Based on previous results that indicate that electricity-powered ships are the most energy-efficient and environmentally friendly option among those considered, five different electricity mixes from different countries (Croatia, China, United States of America (USA), European Union (EU) and Norway), are observed to investigate the effect of electricity mix used on calculated *EEI*, Figure 9.

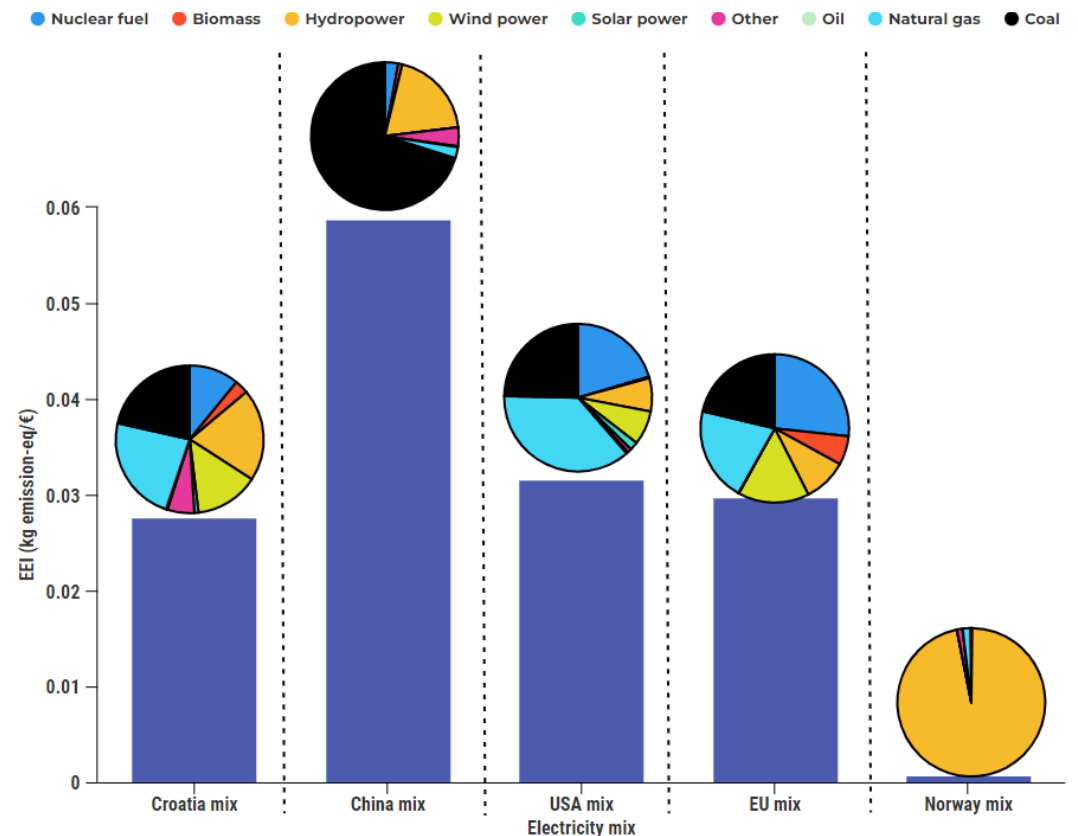

Figure 9. Impact of different electricity mixes on *EEI*.

According to the results presented in Figure 9, it can be concluded that even though the fully electric ship offers zero-emission shipping, and it results with the lowest *EEI*

among considered alternative solutions, the energy sources used for the electricity generation greatly affects the *EEI*. If the electrified Ship 2 is powered by Chinese electricity mix, where electricity is generated mostly from coal (around 70%), the *EEI* compared to a diesel-powered ship would be lower for 65%, while with Croatian mix, the *EEI* is lower for 84%. Moreover, by using the Norwegian electricity mix, where around 98% of electricity is obtained from hydropower, the reduction of *EEI* would be 99.5%, compared to a diesel-powered ship.

Most alternative fuels that are investigated for maritime purposes still have fossil origin and their combustion but also their production results in high emissions. The emphasis needs to be put on the production of alternative fuels in a different and more environmentally friendly way. In order to investigate the impact of different fuel pathway production on *EEI*, energy efficiency and environmental friendliness of Ship 2 powered by grey (Gy-H) and green hydrogen (Gn-H) are compared in Figure 10.

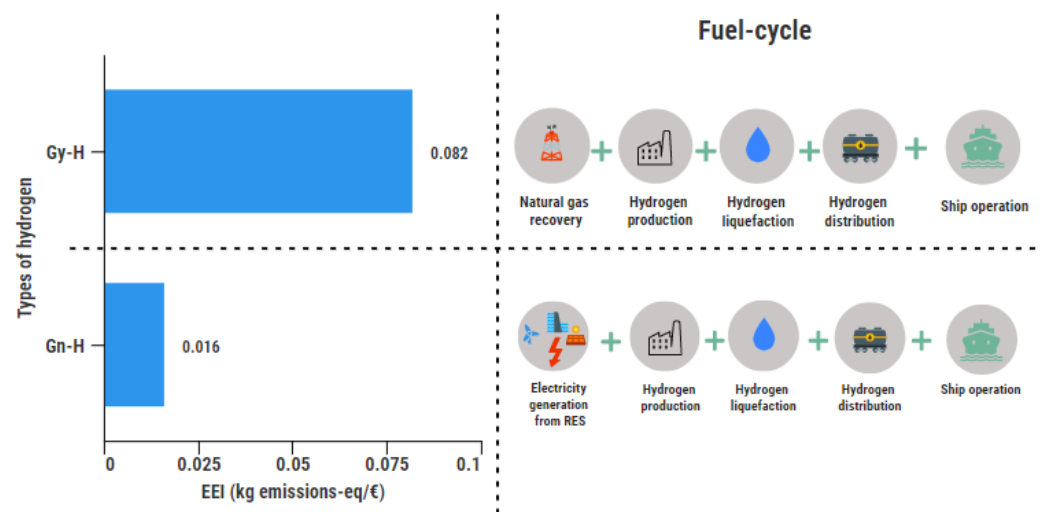

Figure 10. Impact of different hydrogen production processes on *EEI*.

The performed comparison in Figure 10 showed that green hydrogen has 80% lower *EEI* than grey hydrogen and even lower *EEI* than fully electrification of a ship. The grey and green hydrogen have the same properties, but their main difference is the way fuel is produced. Grey hydrogen, i.e. fossil hydrogen, is produced from natural gas, while green hydrogen is produced from electricity generated by RESs. The use of green hydrogen instead of grey hydrogen results in 84% lower CO₂-eq emissions, 53% lower NO_x emissions and 95% lower SO_x emissions. Although it is a very environmentally friendly fuel, the total costs for a ship power system fuelled with green hydrogen are around 60% higher than for grey hydrogen, due to the higher price of green hydrogen (5.8 €/kg) in comparison to the price of grey hydrogen (3.3 €/kg).

Fuels considered in this paper can be supplied to Croatia from different distribution chains. In order to investigate the impact of different fuel supplies on *EEI*, a comparison of LNG supply from the United Arab Emirates (UAE) and the USA was performed, Figure 11.

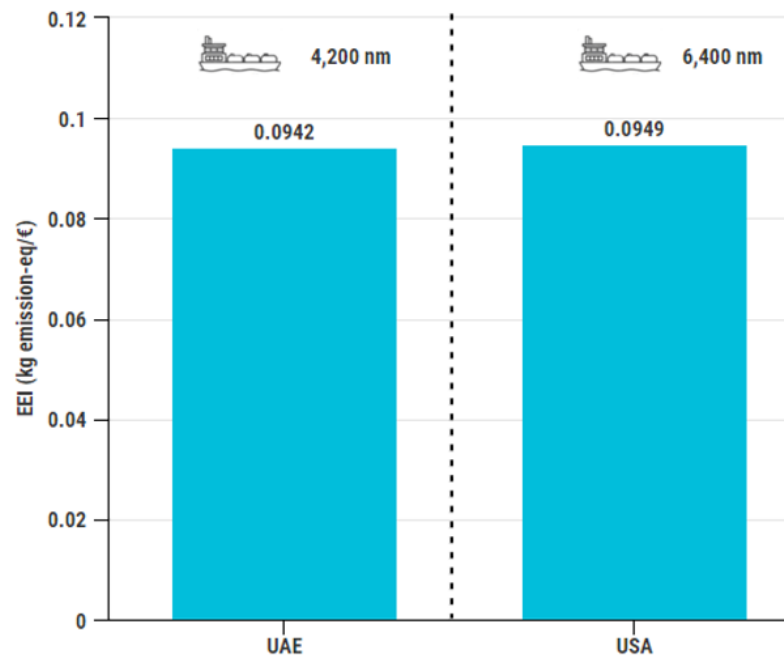

Figure 11. Impact of LNG distribution chains on *EEI*.

The stationary processes of the fuel cycle remain the same, while transportation processes within LCA are modified with different distances travelled by LNG carriers, i.e. around 6,400 nm and around 4,200 nm for LNG supply from the USA and UAE to the Croatian LNG terminal. The process of use of LNG in a ship power system contributes the most to the atmosphere pollution, while the emissions related to the process of distributing the fuel to the refuelling stations are minor concerning total emissions. It is evident that although distribution chains affect the *EEI*, their impact is negligible. In the formulation of the *EEI*, the weighting factors are used. As elaborated above, the literature offers different values of such factors, and their selection is specific to the area of application. The sensitivity analysis of the weighting factors on *EEI* of Ship 2 is performed, where the considered weighting factors are varied by $\pm 50\%$, with a step increment of 10%, Figure 12.

532
533
534
535
536
537
538
539
540
541
542
543
544
545
546
547

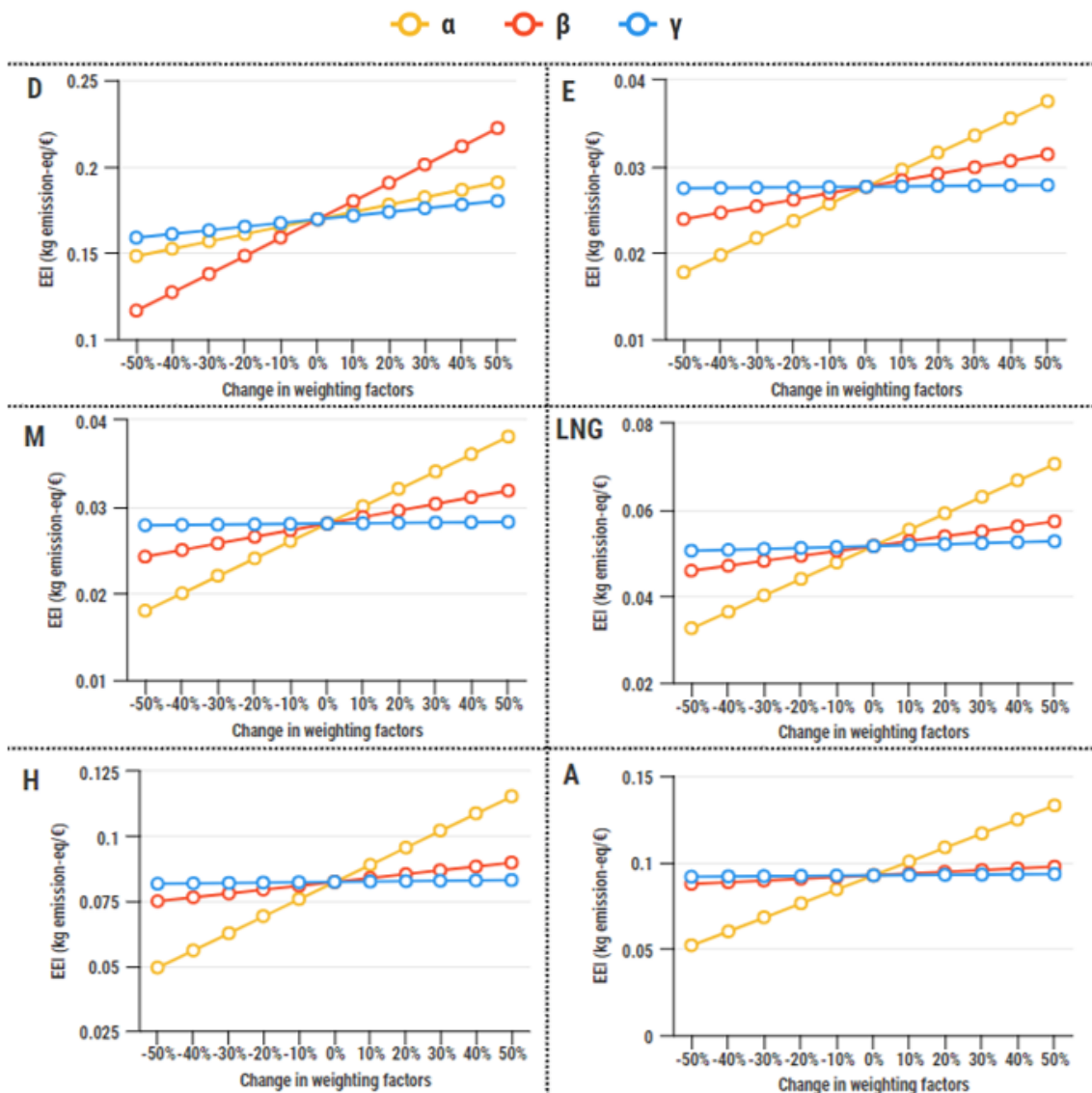

Figure 12. Impact of weighting factors on *EEI*

Along with the weighting factors, emissions and *BS* highly impact the *EEI*. The great difference between compared power system configurations can be seen by changing factor β since the diesel-powered ship results in much greater NO_x but also SO_x emissions than other configurations.

The formulations of *GWP*, *AP* and *EP* also have an impact on the *EEI*. In the literature, there are different ways of formulating these potentials, especially when different equivalence factors are used. No matter the way of their formulation, the *EEI* still represents the ratio of environmental impact and *BS*, and it is a valid formulation for the evaluation of the energy efficiency and environmental friendliness of different ship power systems, while general formulation presented in this work allows further adaptations for specific application cases.

4. Conclusions

The energy efficiency regulation in the maritime sector aims to increase the energy efficiency of ships but also to reduce fossil fuel consumption and emissions. Implementation of EEXI as an energy efficiency index for existing ships is expected from 2023, while EEDI applies to only new-build ships. However, currently used mathematical models for ship energy efficiency, that set the analysis boundaries at the level of ship power system,

548
549
550
551
552
553
554
555
556
557
558
559
560
561
562
563
564
565
566
567
568

do not include alternative fuels as a powering option. Technical measure of energy efficiency needs to be adjusted also for ships powered by alternative fuels since the IMO's decarbonization strategy advocates the application of alternative ship power, which would lead to an increase in energy efficiency and the reduction of shipping emissions. Based on this, the necessity for mathematical models to evaluate energy efficiency of future ships powered by alternative energy sources is evident.

In this paper, the energy efficiency and emission index applicable for ships with alternative powering options (*EEI*) is formulated, taking into account different environmental impact categories, i.e. global warming, acidification and eutrophication, while the results are illustrated on the Croatian ro-ro passenger fleet. Besides diesel that serves as a baseline scenario, applications of alternative powering options like electricity, methanol, liquefied natural gas, hydrogen and ammonia are considered. By extending the analysis boundaries from ship power system to the complete fuel cycle it is possible to compare different ships within the considered fleet or a whole shipping sector from a viewpoint of energy efficiency and environmental friendliness. By performing the LCA of different fuels, the annual life-cycle emissions of GHG, NO_x and SO_x are obtained, while the economic analysis results in the annual economic profit for a particular ship. The *EEI* comparison of ships with different power systems indicated that electrification represents the best energy-efficient and environmentally friendly alternative solution among those considered.

However, bearing in mind that ro-ro passenger ships operate in different regimes, with ship-owners that utilize slow steaming, the analysis of speed reduction for ships with different power systems is performed. The impact of slow steaming is evaluated on ships that operate on the short (Ship 1), and medium-range (Ship 2) and long routes (Ship 3). The analysis indicated that speed reduction and full electrification represent an optimal combination of technical and operational measures that results in lower costs, emissions and *EEIs* for each of considered ships. The difference is that Ship 1 achieves the greatest reduction at speed reduction of 60% of design speed, while for Ship 2 and Ship 3, that reduction is 40% of design speed.

By implementation of identified optimal combination of measures, the duration of Ship 1 would be extended for 15 minutes, while the GHG emissions, costs and *EEIs* compared to the diesel-powered ship operating at average speed are reduced by 55%, 77%, and 92%, respectively. Since the average speed of Ship 2 is close to the speed of 40% of design speed, the optimal combination would result in a prolonged trip by only 6 minutes, while the GHG emissions, costs and *EEIs* compared to the existing ships are reduced by 50%, 48%, and 84%. The optimal identified combination of measures for Ship 3 results in lower GHGs, costs and *EEI* by 58%, 54% and 88%, respectively, but also results in the prolongation of the trip by 52 minutes.

The formulated *EEI* combines both technical and operative characteristics of a ship, as well as characteristics of navigation area, since the specific production of some fuel, fuel distribution chains, electricity mix and other characteristics that are location specific have an impact on the environmental friendliness of a ship. With the presented cost assessment scheme, the model can be used not only for the design of future ship power systems but also for long-term planning of energy-efficient and environmentally friendly fleets or local planning of the low-emission shipping sector.

Author Contributions: Conceptualization, M.P. and N.V.; methodology, M.P. and N.V.; software, M.P.; validation, N.V. and A.F.; formal analysis, M.P.; investigation, M.P. and N.V.; resources, M.P.; data curation, M.P.; writing—original draft preparation, M.P. and I.J.; writing—review and editing, N.V. and A.F.; visualization, M.P., A.F. and I.J.; supervision, N.V.; project administration, N.V.; funding acquisition, N.V. All authors have read and agreed to the published version of the manuscript.

Funding: This research was funded by the Croatian Science Foundation under the project Green Modular Passenger Vessel for Medi-terranean (GRiMM), (Project No. UIP-2017-05-1253) as well as

within the Croatian-Chinese bilateral project “Energy Efficient and Environmentally Friendly Power System Options for Inland Green Ships” between the University of Zagreb, Faculty of Mechanical Engineering and Naval Architecture (Croatia) and Wuhan University of Technology (China). Maja Perčić, a Ph.D. student, is supported through the “Young re-searchers' career development project – training of doctoral students” of the Croatian Science Foundation, funded by the European Union from the European Social Fund (ESF). Ivana Jovanović, a Ph.D. student is supported through the “Young re-searchers' career development project – training of doctoral students” of the Croatian Science Foundation.

Conflicts of Interest: The authors declare no conflict of interest.

References

1. United Nations Framework Convention Climate Change (UNFCCC). Climate Change Information kit. Available online: <https://unfccc.int/resource/iuckit/ckkit2001en.pdf>, (accessed March 05, 2021).
2. Odeh, N.A.; Cockerill, T.T. Life cycle GHG assessment of fossil fuel power plants with carbon capture and storage. *Energy Policy* **2008**, *36*, 367–80.
3. Ait Allal, A.; Mansouri, K.; Youssfi, M.; Qbadou, M. Toward an evaluation of marine fuels for a clean and efficient autonomous ship propulsion energy. *Materials Today: Proceedings* **2019**, *13*, 486–495.
4. International Maritime Organization. Resolution MEPC.176(58), London, UK, 2008.
5. Chen, L.; Yip, T.L.; Mou, J. Provision of Emission Control Area and the impact on shipping route choice and ship emissions. *Transportation Research Part D: Transport and Environment* **2018**, *58*, 280–291.
6. Emission Standards: IMO Marine Engine Regulations. Available online: <https://dieselnet.com/standards/inter/imo.php#s> (accessed on 05 October 2021).
7. International Maritime Organization. Resolution MEPC. 203(62), 2011.
8. Ozaki, Y.; Larkin, J.; Tikka, K.; Michel, K. An Evaluation of the Energy Efficiency Design Index (EEDI) Baseline for Tankers, Containerships, and LNG Carriers. SNAME & Marine Board Symposium 2010 – Climate Change and Ships: Increasing Energy Efficiency.
9. DNV. Energy Efficiency Existing Ship Index (EEXI). Available online: <https://www.dnv.com/maritime/insights/topics/eexi/index.html>, (accessed March 01, 2022).
10. Marine Environment Protection Committee. Resolution MEPC.334(76) - Annex 8 - Guidelines on survey and certification of the attained energy efficiency existing ship index (EEXI), 2021.
11. DNV. Carbon Intensity Indicator. Available online: <https://www.dnv.com/maritime/insights/topics/CII-carbon-intensity-indicator/index.html>, (accessed March 18, 2022).
12. Lindstad, E.; Borgen, H.; Eskeland, G.S.; Paalson, C.; Psaraftis, H.; Turan, O. The Need to Amend IMO’s EEDI to Include a Threshold for Performance in Waves (Realistic Sea Conditions) to Achieve the Desired GHG Reductions. *Sustainability* **2019**, *11*(13), 3668.
13. Ančić, I.; Vladimir, N.; Cho, D.S. Determining environmental pollution from ships using Index of Energy Efficiency and Environmental Eligibility (I4E). *Marine Policy* **2018**, *95*, 1–7.
14. Ančić, I.; Vladimir, N.; Runko Luttenberger, L. Energy efficiency of ro-ro passenger ships with integrated power system. *Ocean Engineering* **2018**, *16*, 350–357.
15. Trivyza, N.L.; Rentizelas, A.; Theotokatos, G. A Comparative Analysis of EEDI Versus Lifetime CO2 Emissions. *Journal of Marine Science and Engineering* **2020**, *8*(1), 61.
16. International Maritime Organization. Fourth IMO GHG study-Final report 2020. Available online: <https://safety4sea.com/wp-content/uploads/2020/08/MEPC-75-7-15-Fourth-IMO-GHG-Study-2020-Final-report-Secretariat.pdf>, (accessed January 14, 2022).
17. Hüffmeier, J.; Johanson, M. State-of-the-Art Methods to Improve Energy Efficiency of Ships. *Journal of Marine Science and Engineering* **2021**, *9*(4), 447.
18. Xing, H.; Spence, S.; Chen, H. A comprehensive review on countermeasures for CO2 emissions from ships. *Renewable and Sustainable Energy Reviews* **2020**, *134* 110222.
19. Bouman, E.A.; Lindstad, E.; Riialand, A.I.; Strømman, A.H. State-of-the-art technologies, measures, and potential for reducing GHG emissions from shipping – A review. *Transportation Research Part D: Transport and Environment* **2017**, *52*, 408–421.
20. Ančić, I.; Perčić, M.; Vladimir, N. Alternative power options to reduce carbon footprint of ro-ro passenger fleet: A case study of Croatia. *Journal of Cleaner Production* **2020**, *271*, 122638.
21. Liu, H.; Zhang, Q.; Qi, X.; Han, Y.; Lu, F. Estimation of PV output power in moving and rocking hybrid energy marine ships. *Applied Energy* **2017**, *204*, 362–372.
22. Perčić, M.; Vladimir, N.; Koričan, M. Electrification of inland waterway ships considering power system lifetime emissions and costs. *Energies* **2021**, *14* (21), 7046.
23. Hansson, J.; Månsson, S.; Brynolf, S.; Grahn, M. Alternative marine fuels: Prospects based on multi-criteria decision analysis involving Swedish stakeholders. *Biomass and Bioenergy* **2019**, *126*, 159–173.

24. Vladimir, N.; Bakica, A.; Perčić, M.; Jovanović, I. Modular approach in the design of small passenger vessels for Mediterranean. *Journal of Marine Science and Engineering* **2022**; *10*(1): 117. 681
682
25. Wan, C.; Yan, X.; Zhang, D.; Yang, Z. A novel policy making aid model for the development of LNG fuelled ships. *Transportation Research Part A: Policy and Practice* **2019**, *119*, 29–44. 683
684
26. Ammar, N.R. An environmental and economic analysis of methanol fuel for a cellular container ship. *Transportation Research Part D* **2019**, *69*, 66–76. 685
686
27. Jovanović, I.; Vladimir, N.; Perčić, M.; Koričan, M. The feasibility of autonomous low-emission ro-ro passenger shipping in the Adriatic Sea. *Ocean Engineering* **2022**, *247*, 110712. 687
688
28. Wang, H.; Boulougouris, E.; Theotokatos, G.; Zhou, P.; Priftis, A.; Shi, G. Life cycle analysis and cost assessment of a battery powered ferry. *Ocean Engineering* **2021**, *241*, 110029. 689
690
29. Gagatsi, E.; Estrup, T.; Halatsis, A. Exploring the potentials of electrical waterborne transport in Europe: the E-ferry concept. *Transportation Research Procedia* **2016**, *14*, 1571-1580. 691
692
30. Perčić, M.; Vladimir, N.; Jovanović, I.; Koričan, M. Application of fuel cells with zero-carbon fuels in short-sea shipping. *Applied Energy* **2022**, *309*, 118463. 693
694
31. Perčić, M.; Ančić, I.; Vladimir, N. Life-cycle cost assessments of different power system configurations to reduce the carbon footprint in the Croatian short-sea shipping sector. *Renewable & sustainable energy reviews* **2020**, *131*, 110028. 695
696
32. Degiuli, N.; Martić, I.; Farkas, A.; Gospić, I. The impact of slow steaming on reducing CO2 emissions in the Mediterranean Sea. *Energy Reports* **2021**, *7*, 8131–8141. 697
698
33. Ritari, A.; Spooft-Tuomi, K.; Huotari, J.; Niemi, S.; Tammi, K. Emission Abatement Technology Selection, Routing and Speed Optimization of Hybrid Ships. *Journal of Marine Science and Engineering* **2021**, *9*(9), 944. 699
700
34. DNV. Uptake of alternative fuels for the world fleet as of June 2021 including ships in operation and on order. Available online: <https://www.dnv.com/maritime/hub/decarbonize-shipping/fuels/bridging-fuels.html>, (accessed April 10, 2022). 701
702
35. Kim, T.; Chae, C. Environmental Impact Analysis of Acidification and Eutrophication Due to Emissions from the Production of Concrete. *Sustainability* **2016**, *8*(6), 578. 703
704
36. Environmental Protection Agency. Understanding Global Warming Potentials. Available online: <https://www.epa.gov/ghgemissions/understanding-global-warming-potentials>, (accessed December 20, 2021). 705
706
37. Gonçalves Castro, M.; Mestemaker, B.; Van Den Heuvel, H. Towards zero emission work vessels: the case of a dredging vessel. In Proceedings of 2nd International Conference on Modelling and Optimisation of Ship Energy Systems (MOSES2019), Glasgow, Scotland, United Kingdom, 2019. 707
708
709
38. Monteiro, A.; Russo, M.; Gama, C.; Borrego, C. How important are maritime emissions for the air quality: At European and national scale. *Environmental Pollution* **2018**, *242*, 565–75. 710
711
39. Sofiev, M.; Winebrake, J.J.; Johansson, L.; Carr, E.W.; Prank, M.; Soares, J.; Vira, J.; Kouznetsov, R.; Jalkanen J.-P.; Corbett J.J. Cleaner fuels for ships provide public health benefits with climate tradeoffs. *Nature Communications* **2018**, *9*(1), 406. 712
713
40. Croatian Register of Shipping. Web report of a ship. Available online: <http://report.crs.hr/hrbwebreports/Default.aspx>, (accessed December 10, 2021). 714
715
41. Jadrolinija. Ferry lines schedule. Available online: <https://www.jadrolinija.hr/redovi-plovidbe-i-cijene/lokalne-linije-2022>, (accessed December 15, 2021). 716
717
42. Coastal Liner Services Agency. Traffic of passengers and vehicles on ferry lines. Available online: http://agencija-zolpp.hr/wp-content/uploads/2022/02/PROMET_PUTNIKA_I_VOZILA_2020-2021.pdf, (accessed February 17, 2022). 718
719
43. Adland, R.; Cariou, P.; Wolff, F.C. Optimal ship speed and the cubic law revisited: Empirical evidence from an oil tanker fleet. *Transportation Research Part E: Logistics and Transportation Review* **2020**, *140*, 101972. 720
721
44. ISO 14040. Available online: <https://www.iso.org/standard/37456.html>, (accessed April 21, 2021). 722
45. GREET 2020. Available online: <https://greet.es.anl.gov/>, (accessed June 30, 2021). 723
46. Perčić, M.; Vladimir, N.; Fan, A. Life-cycle cost assessment of alternative marine fuels to reduce the carbon footprint in short-sea shipping: A case study of Croatia. *Applied Energy* **2020**, *279*, 115848. 724
725
47. Perčić, M.; Vladimir, N.; Fan, A. Techno-economic assessment of alternative marine fuels for inland shipping in Croatia. *Renewable and Sustainable Energy Reviews* **2021**, *148*, 111363. 726
727
728